

FAB32URCR3

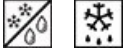

Product Family	Refrigerator
Installation	Free standing
Category	Bottom Mount
Reference width	Until 60
Sistema Total No - Frost	Total
Cooling type	No Frost
Defrost	Automatic
Hinge position	Right
EAN code	8017709271978



Aesthetics

Colour	Cream	Logo	Applied
Finishing	Glossy	Door shelves profile color	Chrome
Aesthetics	50's Style	Drawers profile color	Chrome
Handle colour	Chrome	Color of glass shelf profile	Chrome
Side material	Steel	Display	7 segments
Side colour	Cream		

Refrigerator compartment features



No. of adjustable shelves	3	Type of crisper/vegetable drawers cover	Glass
Number of fruit and vegetables drawers	1	Life Plus zone-0°C	Yes, with electronic control
Type of adjustable shelves	Glass	Internal light in fridge	Yes
Type of crisper/vegetable drawers cover	Standard	Type of internal light (fridge)	LED
Crisper Cover	Yes		

Refrigerator Inner Door

No. of door shelves with transparent cover	1	No. of bottle shelves	1
Number of adjustable door shelves	2	Bottle shelves with wire support	Yes

Adjustable door shelves Yes
with wire support

Other Refrigerator features



Accessories
MultiFlow

Egg tray
Yes

Fan

Yes

Freezer compartment features

Number of drawers 2
No. of compartments 1
with flap

Type of shelves Plastic

Other Freezer features



Accessories

1 ice box

Fast freezing
compartment

Yes

Other technical features



Functions display

Holiday, Fast freezing, Fast cooling, ECO, Temperature alarm

Fast freezing button

Yes

Power on lamp

Yes

Temperature alarm lamp

Yes

Door open alarm

Acoustic and visual

Temperature Alarm

Yes

Type of temperature control

Electronic

No. of compressors

1

Refrigerant gas type

R600a

Type of compressor

Inverter

Refrigerant Quantity (gr)

2.1 oz

Foam agent

Cyclopentane

Performance / Energy Label - Reg. 2019

Airborne acoustical
noise emissions 37 dB(A) re 1pW

Gross volume frozen
food compartment







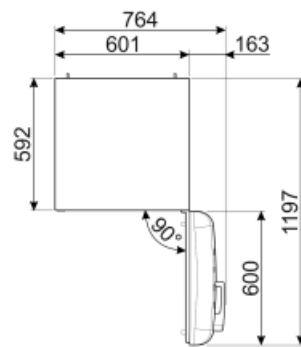
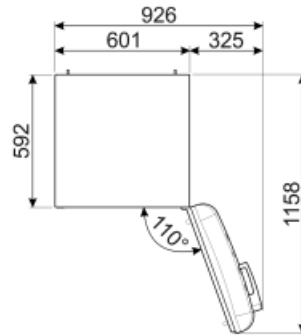
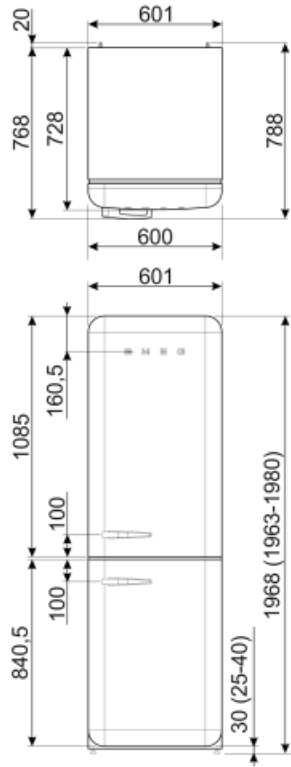



3.99 cu. ft.

Electrical Connection

Plug	(A) USA e Messico	Voltage (V)	115 V
Electrical connection rating	127 W	Frequency (Hz)	50/60 Hz
Current	1.2 A	Power supply cable length	78 3/4 "



Symbols glossary (TT)

- | | | | |
|--|--|---|--|
|  | The automatic defrost system works by automatically defrosting at regular intervals eliminating the need to defrost altogether. |  | Economical mode: Analyzes fridge functioning during the activation and optimizes the operating cycle in order to reduce power consumption. |
|  | Ventilated: Forced distribution of cold air in the refrigerator compartment, which allows even temperature distribution within the fridge. |  | Fast freezing: The fast freezing function brings the temperature of the compartment down when activated a few hours prior to usage. |
|  | Power saving mode: The power saving mode allows you to disable the refrigerator and keep the freezer working. |  | LED interior lighting: is a more energy efficient and long lasting way of illuminating the interior of the appliance. |
|  | Life Plus 0°C: The temperature in the Lifeplus compartments is kept at 0°C, which preserves fresh meat and fish longer. |  | Smeg's evolution towards more intelligent and eco-friendly models has led to the choice of Inverter technology, which significantly reduces consumption. |
|  | Air plus: keeps food fresher for longer. |  | No Frost: The No Frost and Frost free systems prevent ice from forming so that no defrosting is required. |