

86UQ7070ZUD 86UQ8000AUB
86UQ7590PUD 86UQ9000PUD

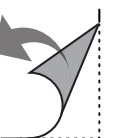

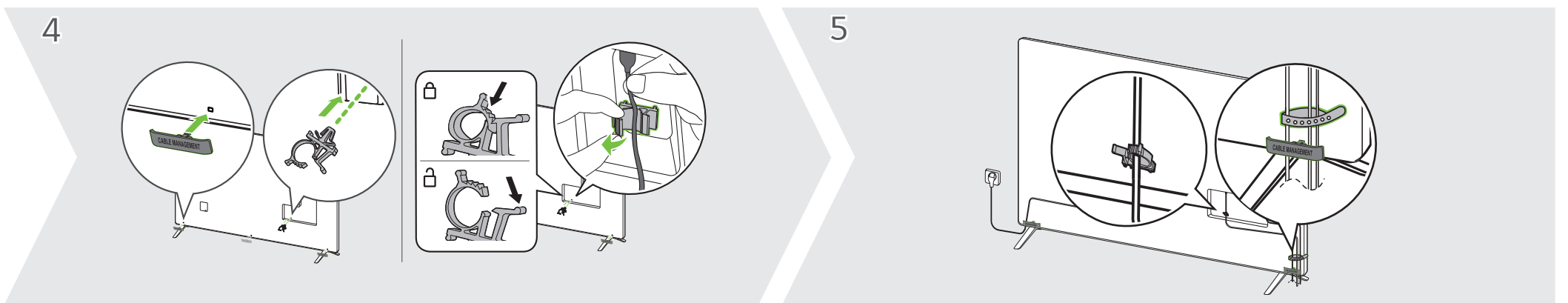

A, B, C, D, E : mm (inches / pulgadas / po)
 F, G : kg (lbs / libras / lb)

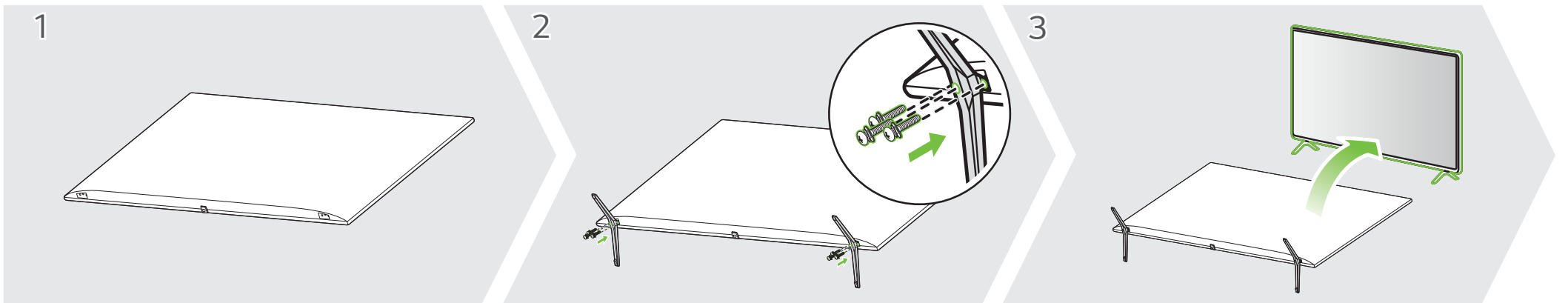
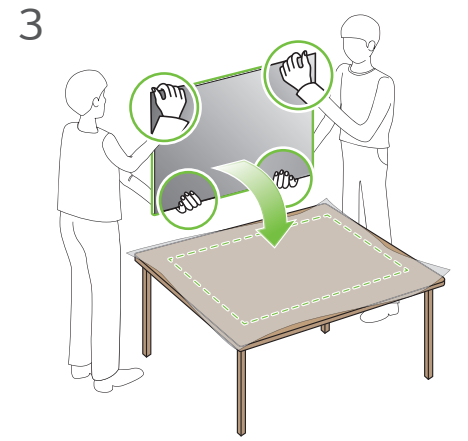
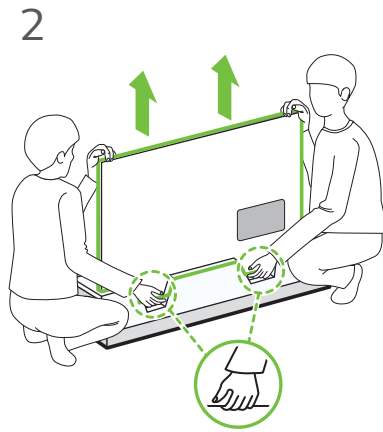
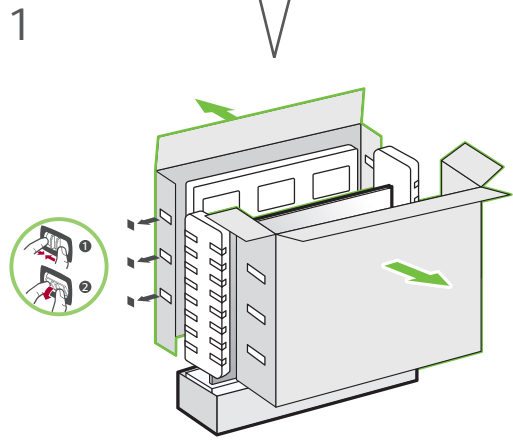
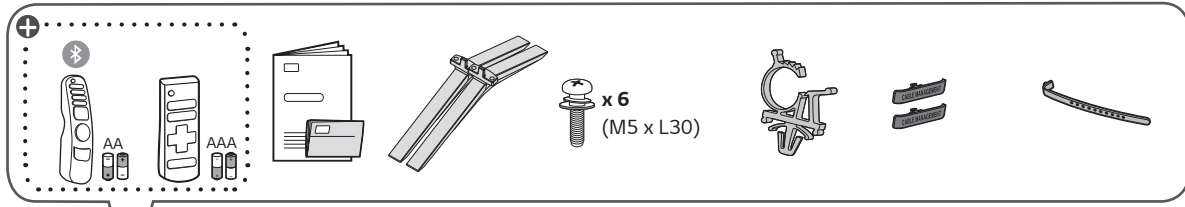
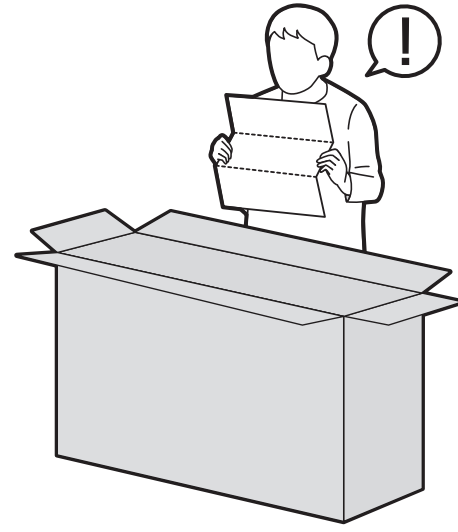
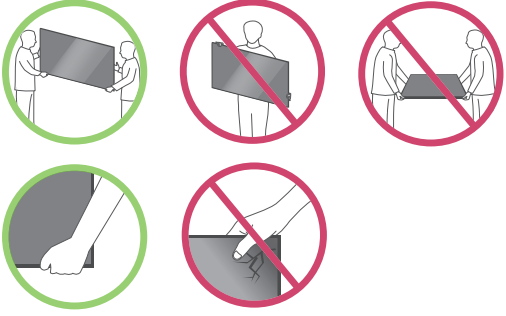
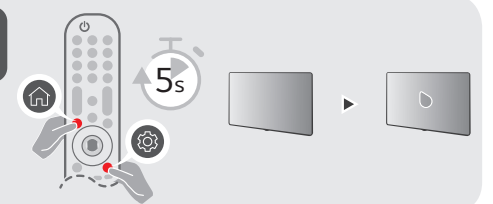
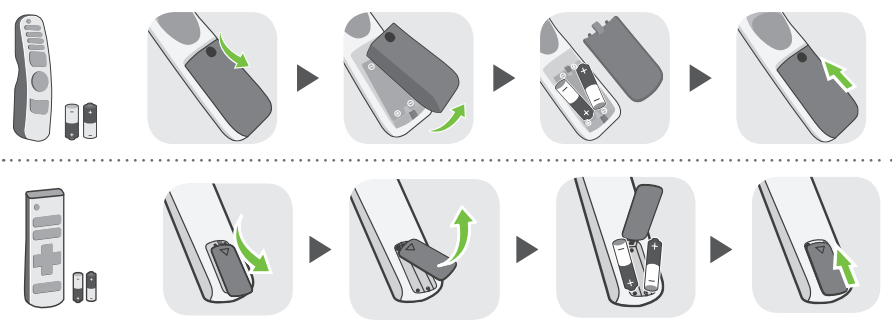
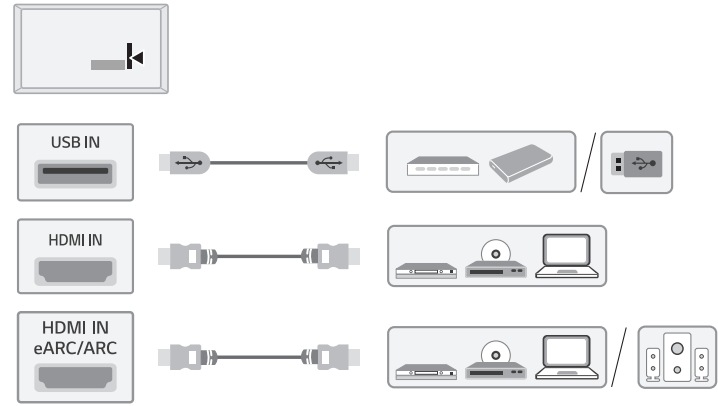
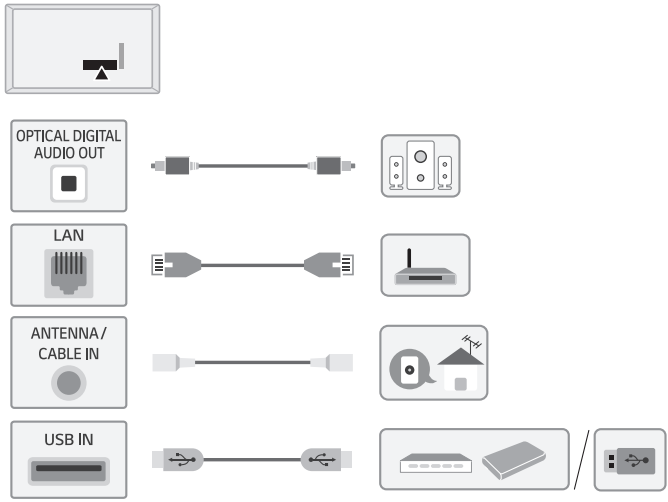
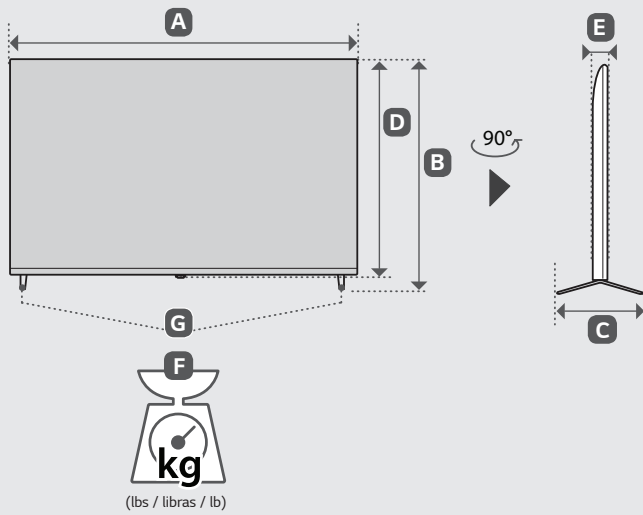

MODELS MODELOS MODÈLES	A		B		C		D		E		F		F - G		Power consumption Consumo de potencia Consommation électrique
	86UQ70ZUD 86UQ8000AUB 86UQ9000PUD 86UQ7590PUD	1,927 (75.8)	1 927 (75,8)	1,167 (45.9)	1 167 (45,9)	361 (14.2)	361 (14,2)	1,104 (43.4)	1 104 (43,4)	59.9 (2.3)	59,9 (2,3)	45.6 (100.5)	45,6 (100,5)	45.2 (99.6)	45,2 (99,6)
Power requirement / Alimentación requerida / Alimentation										AC 120 V- 50/60 Hz					

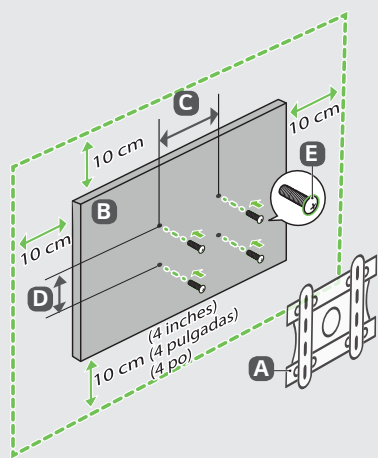

C, D : mm (inches / pulgadas / po)

A	B	C x D (mm)	E
LSW640B	86UQ70* 86UQ75* 86UQ80* 86UQ90*	600 (23.6) x 400 (15.7)	M8
		600 (23,6) x 400 (15,7)	



ENGLISH Read **Safety and Reference**.
ESPAÑOL Leer **Seguridad y Consultas**.
FRANÇAIS Lisez **Sécurité et références**.

ENGLISH
Easy Setup Guide
 Please read this manual carefully before operating your set and retain it for future reference.

ESPAÑOL
Guía Rápida de Configuración
 Lea atentamente este manual antes de poner en marcha el equipo y consérvelo para futuras consultas.

FRANÇAIS
Guide de configuration rapide
 Avant d'utiliser l'appareil, veuillez lire attentivement ce manuel et le conserver pour pouvoir vous y reporter ultérieurement.

⊕ : Depending upon model / Según el modelo / Selon le modèle