



ROTEL®

CD14MKII

Stereo Compact Disc Player

Lecteur de disque compac

Stereo-CD-Player

Lettore CD

Reproductor de Discos Compactos

CD-Speler

CD-spelare

CD-проигрыватель

Owner's Manual

Manuel d'utilisation

Bedienungsanleitung

Manual de Instrucciones

Manuale di istruzioni

Gebruiksaanwijzing

Instruktionsbok

Инструкция пользователя

CAUTION

RISK OF ELECTRIC SHOCK
DO NOT OPEN

WARNING : SHOCK HAZARD-DO NOT OPEN
AVIS: RISQUE DE CHOC ÉLECTRIQUE-NE PAS OUVRIR

This symbol is to alert the user to the presence of uninsulated dangerous voltages inside the product's enclosure that may constitute a risk of electric shock.

This symbol is to alert the user to important operating and maintenance (service) instructions in this manual and literature accompanying the product.

APPLICABLE FOR USA, CANADA OR WHERE APPROVED FOR THE USAGE

CAUTION: TO PREVENT ELECTRIC SHOCK, MATCH WIDE BLADE OF PLUG TO WIDE SLOT. INSERT FULLY.

ATTENTION: POUR EVITER LES CHOCS ELECTRIQUES, INTRODUIRE LA LAME LA PLUS LARGE DE LA FICHE DANS LA BORNE CORRESPONDANTE DE LA PRISE ET POUSSER JUSQU'AU FOND.

This Class B digital apparatus complies with Canadian ICES-003.

Cet appareil numérique de la classe B est conforme à la norme NMB-003 du Canada.

Rotel products are designed to comply with international directives on the Restriction of Hazardous Substances (RoHS) in electrical and electronic equipment and the disposal of Waste Electrical and Electronic Equipment (WEEE). The crossed wheeled bin symbol indicates compliance and that the products must be appropriately recycled or processed in accordance with these directives.

This symbol means that this unit is double insulated. An earth connection is not required.

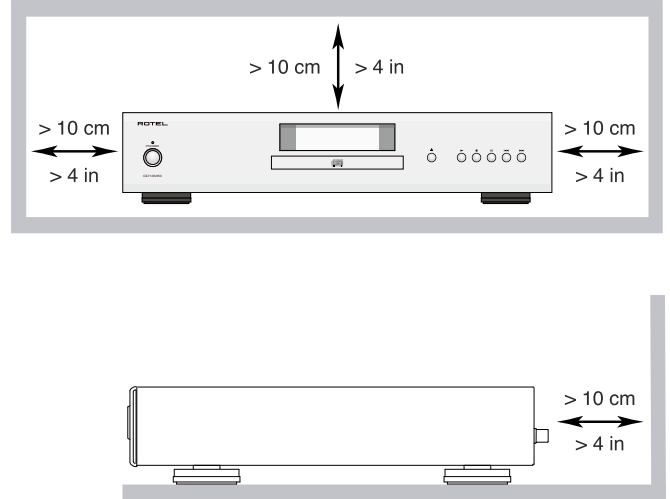

IMPORTANT FOR LASER PRODUCT

1. CLASS 1 LASER PRODUCT
2. **DANGER:** Visible laser radiation when open and interlock failed or bypassed. Avoid direct exposure to beam.
3. **CAUTION:** Do not open the top cover. There are no user serviceable parts inside the player; leave all servicing to qualified service personnel.

WARNING!

To reduce the risk of electrical shock, fires, etc.:

1. Do not remove screws, covers or cabinet.
2. Do not expose the unit to rain or moisture.
3. Do not touch the power cord or plug with wet hands.

Important Safety Instructions

Notice

The RS232 connection should be handled by authorized persons only.

WARNING: There are no user serviceable parts inside. Refer all servicing to qualified service personnel.

WARNING: To reduce the risk of fire or electric shock, do not expose the unit to moisture or water. Do not expose the unit to dripping or splashing. Do not place objects filled with liquids, such as vases, on the unit. Do not allow foreign objects to get into the enclosure. If the unit is exposed to moisture, or a foreign object gets into the enclosure, immediately disconnect the power cord from the wall. Take the unit to a qualified service person for inspection and necessary repairs.

Read these instructions.

Keep these instructions.

Heed all warnings.

Follow all instructions.

Do not use this apparatus near water.

Clean only with dry cloth.

Do not block any ventilation openings. Install in accordance with the manufacturer's instructions.

Do not install near any heat sources such as radiators, heat registers, stoves, or other apparatus (including amplifiers) that produce heat.

Do not defeat the safety purpose of the polarized or grounding-type plug. A polarized plug has two blades with one wider than the other. A grounding type plug has two blades and a third grounding prong. The wide blade or the third prong are provided for your safety. If the provided plug does not fit into your outlet, consult an electrician for replacement of the obsolete outlet.

Protect the power cord from being walked on or pinched particularly at plugs, convenience receptacles, and the point where they exit from the apparatus.

Only use attachments/accessories specified by the manufacturer.

Use only with the cart, stand, tripod, bracket, or table specified by the manufacturer, or sold with the apparatus. When a cart is used, use with caution when moving the cart/apparatus combination to avoid injury from tip-over.



Unplug this apparatus during lightning storms or when unused for long periods of time.

Refer all servicing to qualified service personnel. Servicing is required when the apparatus has been damaged in any way, such as power supply cord or plug is damaged, liquid has been spilled or objects have fallen into the apparatus, the apparatus has been exposed to rain or moisture, does not operate normally, or has been dropped.

The apparatus should be used in non tropical climate.

The ventilation should not be impeded by covering the ventilation openings with items, such as newspapers, table-cloths, curtains, etc.

No naked flame sources, such as lighted candles, should be placed on the apparatus.

Touching uninsulated terminals or wiring may result in an unpleasant sensation.

You must allow a minimum 10 cm or 4 inches of unobstructed clearance around the unit.

WARNING: The rear panel power cord connector is the mains power disconnect device. The device must be located in an open area that allows access to the cord connector.

The unit must be connected to a power supply only of the type and voltage specified on the rear panel. (USA: 120 V/60Hz, EC: 230V/50Hz)

Connect the component to the power outlet only with the supplied power supply cable or an exact equivalent. Do not modify the supplied cable. Do not use extension cords.

The mains plug is the disconnect of the unit. In order to completely disconnect the unit from the supply mains, remove the main plug from the unit and the AC power outlet. This is the only way to completely remove mains power from the unit.

The batteries in the remote control should not be exposed to excessive temperature such as sunshine, fire or other heat sources. Batteries should be recycled or disposed as per state and local guidelines.

FCC Information

This equipment has been tested and found to comply with the limits for a Class B digital device, pursuant to Part 15 of the FCC Rules. These limits are designed to provide reasonable protection against harmful interference in a residential installation. This equipment generates, uses and can radiate radio frequency energy and, if not installed and used in accordance with the instruction, may cause harmful interference to radio communications.

However, there is no guarantee that interference will not occur in a particular installation. If this equipment does cause harmful interference to radio or television reception, which can be determined by turning the equipment off and on, the user is encouraged to try to correct the interference by one or more of the following measures:

- Reorient or relocate the receiving antenna.(TV, radio, etc.)
- Increase the separation between the equipment and receiver.
- Connect the equipment to an outlet on circuit different from that to which the receiver is connected.
- Consult the dealer or an experienced radio/TV technician for additional help.

Caution

This device complies with part 15 of the FCC Rules. Operation is subject to the following conditions: (1) This device may not cause harmful interference, and (2) this device must accept any interference received, including interference that may cause undesired operation.

NOTE: This equipment has been tested and found to comply with the limits for a Class B digital device, pursuant to Part 15 of the FCC Rules. These limits are designed to provide reasonable protection against interference in a residential installation. This equipment generates and can radiate radio frequency energy and, if not installed and used in accordance with the instructions, may cause interference to radio or TV communications. There is no guarantee that interference will not occur in a particular installation. If this equipment does cause interference to radio or television reception, which can be determined by turning the equipment off and on, try to correct the interference by one or more of the following measures:

- Reorient or relocate the receiving antenna.
- Increase the separation between the unit and the television tuner.
- Connect the unit to an AC power outlet on a different electrical circuit.
- Consult your authorized Rotel retailer for assistance.

Figure 1: Controls and Connections
 Commandes et branchements
 Bedienelemente und Anschlüsse
 Controles y Conexiones

Controlli e connessioni
 De bedieningsorganen en aansluitingen
 Kontroller och anslutningar
 Органы управления и разъемы

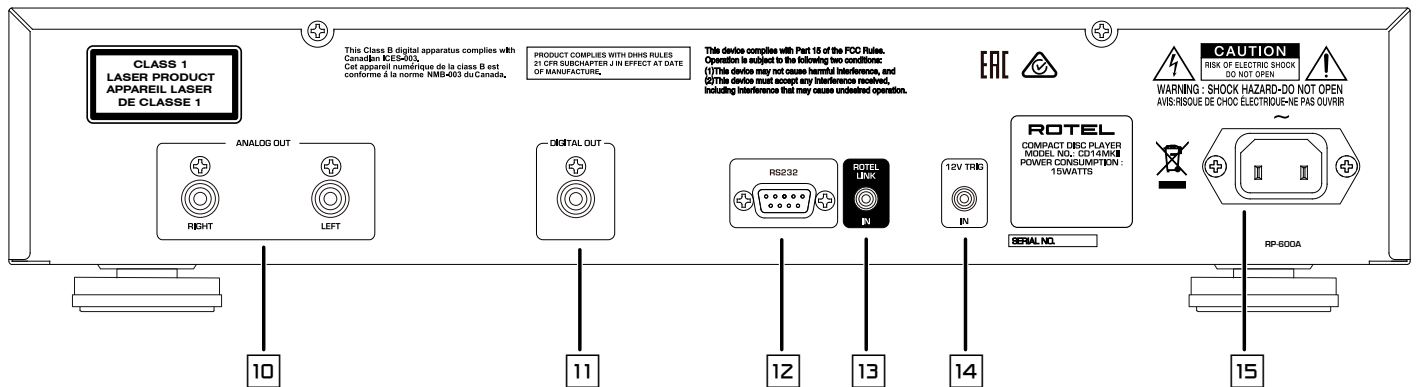
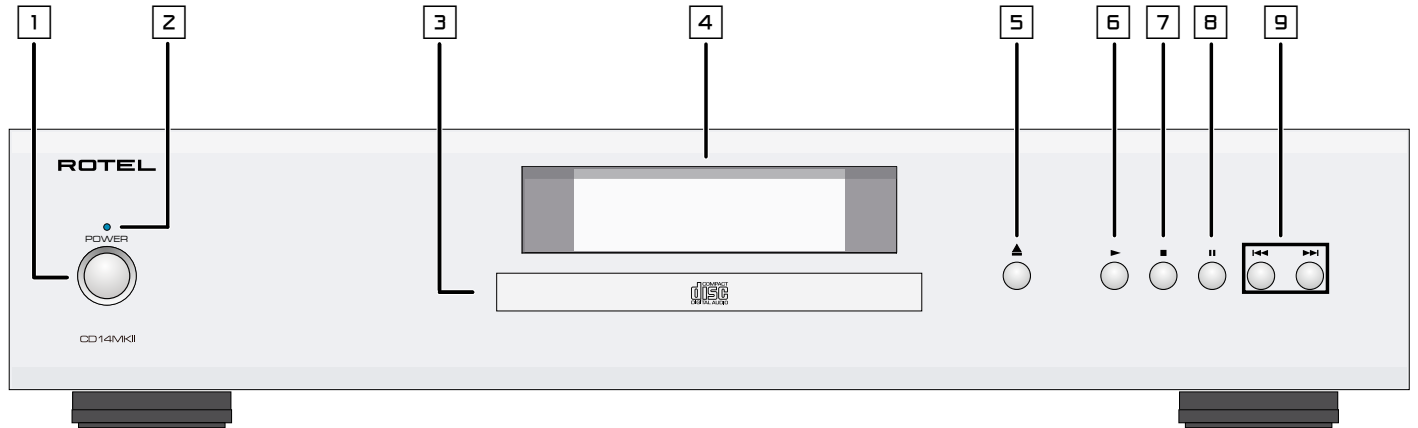

Figure 2: RR-D99 Remote Control
Télécommande RR-D99
Fernbedienung RR-D99
Telecomando RR-D99
Mando a Distancia RR-D99
De RR-D99 afstandsbediening
Fjärrkontroll RR-D99
Пульт ДУ RR-D99

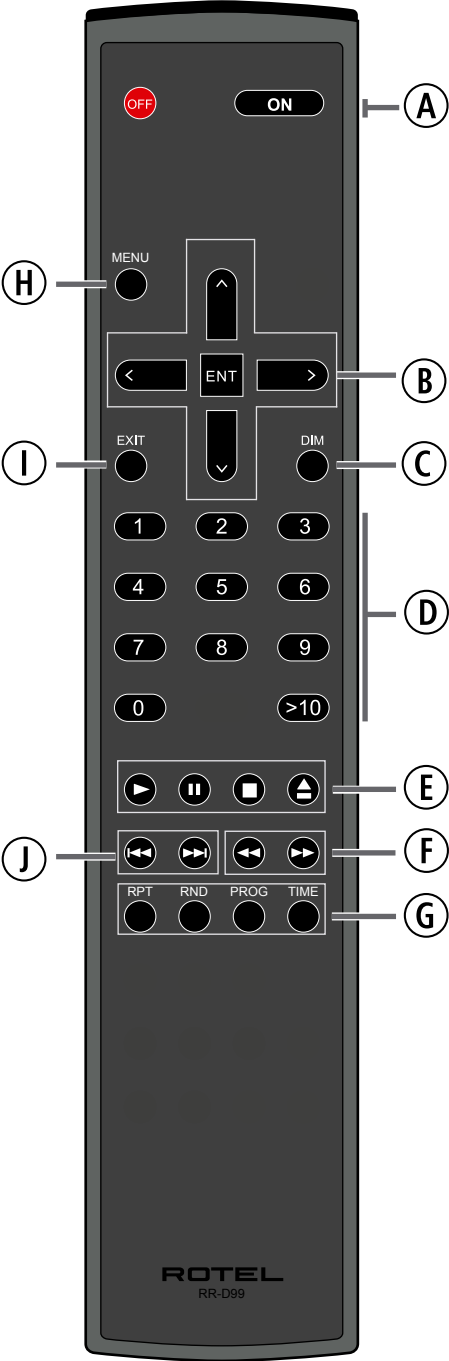
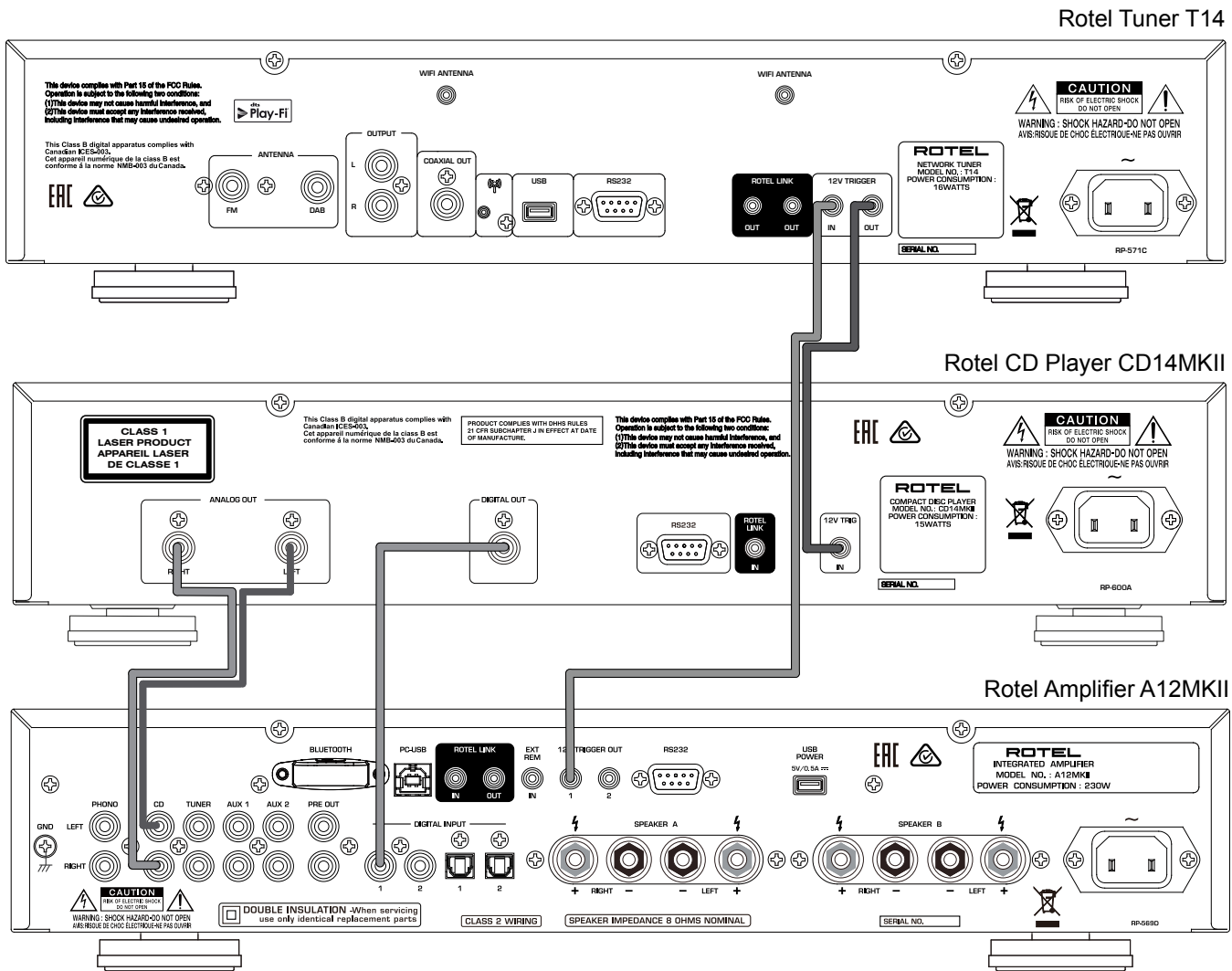

Figure 3: Connections
 Connexions
 Anschlussdiagramm
 Conexiones
 Collegamenti
 De verbindingen
 Anslutningar
 Подсоединения



Important Notes

When making connections be sure to:

- ✓ Turn off **all** the components in the system **before** hooking up **any** components, including loudspeakers.
- ✓ Turn off **all** components in the system **before** changing **any** of the connections to the system.

Remarques importantes

Pendant les branchements, assurez-vous que :

- ✓ **Tous** les maillons sont éteints **avant** leur branchement, **quels qu'ils soient**, y compris les enceintes acoustiques.
- ✓ Éteignez **tous** les maillons **avant** de modifier **quoi que ce soit** au niveau de leurs branchements, quels qu'ils soient.

Wichtige Hinweise

Achten Sie beim Herstellen der Verbindungen auf Folgendes:

- ✓ Schalten Sie **alle** Komponenten im System ab, **bevor** Sie Geräte (einschließlich Lautsprecher) anschließen.
- ✓ Schalten Sie **alle** Komponenten im System ab, **bevor** Sie Anschlüsse im System verändern.

Notas Importantes

Cuando realice las conexiones, asegúrese de que:

- ✓ Desactiva **todos** los componentes del equipo, cajas acústicas incluidas, **antes** de conectar **cualquier nuevo componente** en el mismo.
- ✓ Desactiva **todos** los componentes del equipo **antes** de cambiar **cualquier conexión del mismo**.

Héél belangrijk

Bij het maken van de verbindingen:

- ✓ Zorg dat niet alleen de CD14MKII, maar de **gehele** installatie uitstaat, als nog niet **alle** verbindingen gemaakt zijn.
- ✓ Zorg dat niet alleen de CD14MKII, maar de **gehele** installatie ook uitstaat, **als** u verbindingen gaat **wijzigen**.

Note importanti

Quando effettuate i collegamenti assicuratevi di:

- ✓ Spegnerne **tutti** i componenti del sistema **prima** di collegare **qualsiasi** componente, inclusi i diffusori.
- ✓ Spegnerne **tutti** i componenti del sistema **prima** di modificare **qualsiasi** connessione nel sistema.

Viktigt

Tänk på följande när du gör anslutningar:

- ✓ Stäng av **alla** apparater i anläggningen **innan** du ansluter nya komponenter eller högtalare.
- ✓ Stäng av **alla** apparater i anläggningen **innan** du ändrar någon anslutning.

Важные замечания

Перед подсоединением:

- ✓ Выключите **все** компоненты, включая колонки.
- ✓ Выключите **все** компоненты в вашей системе, прежде чем что-то в ней **менять**.

Contents

Important Safety Instructions	3
Figure 1: Controls and Connections	4
Figure 2: Remote Control RR-D99	5
Figure 3: Connections	6
Important Notes	7
About Rotel	8
About the CD14MKII	8
Getting Started	9
A Few Precautions	9
Placement	9
Control Identification	9
AC Power and Control	9
AC Power Input ^[5]	9
Power Switch ^[1] (A) and POWER Indicator ^[Z]	9
12V Trigger Connection ^[14]	9
Output Connections	9
Analog Outputs ^[10]	10
Digital Output ^[11]	10
Operation	10
Infrared Remote Control	10
Display ^[4]	10
Disc Tray ^[3]	10
Transport Control Buttons	10
EJECT Button ^[5] (E)	10
PLAY Button ^[6] (E)	10
STOP Button ^[7] (E)	10
PAUSE Button ^[8] (E)	10
TRACK Buttons ^[9] (J)	10
DIRECT ACCESS Buttons ^[10]	10
Search Buttons ^[11]	11
Additional Features	11
PROGRAM Button ^[12]	11
RANDOM Button ^[13]	11
REPEAT Button ^[14]	11
TIME Button ^[15]	11
RS232 ^[12]	11
Rotel Link ^[13]	11
Remote Control Advanced Buttons	12
MENU Button ^[H]	12
DIM Button ^[C]	12
Troubleshooting	12
Power Indicator Is Not Illuminated	12
Fuse Replacement	12
No Sound	12
Specifications	13

About Rotel

Our story began over 60 years ago. Over the decades, we have received hundreds of awards for our products and satisfied hundreds of thousands of people who take their entertainment seriously – like you!

Rotel was founded by a family whose passionate interest in music led them to manufacture high-fidelity components of uncompromising quality. Through the years, that passion has remained undiminished and the family goal of providing exceptional value for audiophiles and music lovers, regardless of their budget, is shared by all Rotel employees.

Rotel's engineers work as a close team, listening to, and fine tuning, each new product until it reaches their exacting musical standards. They are free to choose components from around the world in order to make that product the best they can. You are likely to find capacitors from the United Kingdom and Germany, semiconductors from Japan or the United States, while toroidal power transformers are manufactured in Rotel's own factory.

We all have concerns about our environment. And, as more and more electronics are produced it is especially important for a manufacturer to do all it can to engineer products that have a minimum impact on the environment.

At Rotel, we are proud to do our part. We have reduced the lead content in our products by using special lead-free ROHS solder and components. Our engineers continually strive to improve power supply efficiency without compromise to quality. When in standby mode Rotel products use minimal power to meet global Standby Power Consumption requirements.

The Rotel factory is also doing their part to help the environment through constant improvements to product assembly methods for a cleaner and greener manufacturing processes.

All of us at Rotel thank you for buying this product. We are sure it will bring you many years of enjoyment.

About the CD14MKII

Simply stated, the unit is designed to do one thing—deliver the most detailed, nuanced sound from every disc. The unit will faithfully reproduce all that is recorded on the disc. While the unit was under development, the design team went far beyond the usual measurable technical performance characteristics. Listening panels spent hundreds of hours fine tuning the audio performance, choosing the components that produced the best sound, that would “release the emotion in the music”. Whatever the artist and recording engineers put on the disc, the unit will deliver.

That said, the unit does feature some impressive hardware. Digital to Analog conversion is processed with a state of the art Texas Instruments 32 bit DAC. All this, combined with Rotel's Balanced Design, ensures the unit will deliver the highest level of audio performance. When used in a high-quality audio system, your Rotel CD player will provide years of enjoyment.

Getting Started

A Few Precautions

WARNING: To avoid potential damage to your system, turn off ALL the components in the system when connecting or disconnecting the loudspeakers or any associated components. Do not turn the system components back on until you are sure all the connections are correct and secure.

Please read this manual carefully. In addition to installation and operating instructions, it provides valuable information on various unit system configurations as well as general information that will help you get optimum performance from your system. Please contact your authorized Rotel dealer for answers to any questions you might have. In addition, all of us at Rotel welcome your questions and comments.

Save the shipping carton and all enclosed packing material for future use. Shipping or moving the unit in anything other than the original packing material may result in severe damage to your unit.

If included in the box please complete the owner's registration card or register on line. Also be sure to keep the original sales receipt. It is your best record of the date of purchase, which you will need in the event warranty service is required.

Placement

Use common sense when placing the unit in a cabinet or when stacking other equipment. Make sure that the shelf or cabinet can support its weight. Do not stack heavy components on top of the unit. Avoid placing the unit where it may be subject to excessive heat such as on top of a large power amplifier or near a heat register. For best performance, avoid placing the unit where it may be subject to vibration, such as near a speaker.

Control Identification

This manual shows illustrations of the front and rear panels and the RR-D99 remote control. Each item in the illustrations is identified with a call out. Through out this manual the items referred to in the text are identified by the corresponding call out. The items on the front and rear panels are identified with a number call out, such as [1]. The items on the remote control are labeled with a letter call out, such as (A).

AC Power and Control

AC Power Input [15]

Your unit is configured at the factory for the proper AC voltage in the country where you purchased it (either 120 volts or 230 volts). The AC line configuration is noted on a decal on the back panel.

NOTE: Should you move your CD player to another country, it may be possible to reconfigure it for use on a different line voltage. Do not attempt to perform this conversion yourself. Opening the enclosure of the unit exposes you to dangerous voltages. Consult a qualified service person or the Rotel factory service department for information.

NOTE: Some products are intended for sale in more than one country and as such are supplied with more than one AC cord. Please use only the cord appropriate for your country/region.

CD14MKII should be plugged directly into a polarized wall outlet using the supplied cable or other high current compatible cable as recommended by your authorized Rotel dealer. Do not use an extension cord.

Be sure the power switch on the front panel of the unit is turned off (in the "out" position). Then, connect the supplied power cord to the AC power receptacle on the rear of the unit and the AC power outlet.

If you are going to be away from home for an extended period of time such as a month-long vacation, it is a sensible precaution to unplug your CD player (as well as other audio and video components) while you are away.

Power Switch [1] (A) and POWER Indicator [Z]

Press the front panel Power Switch button [1] to turn the unit on. The Power Indicator light [Z] is illuminated when the unit is on. Press Power Switch button again to turn the unit off.

When the Power switch is in the ON position, the remote control ON and OFF (A) buttons may be used to activate the CD player or put it in Standby mode. In Standby mode the LED indicator above the power switch is red, but the display is turned off.

NOTE: If you are using a switched outlet to turn on and off your CD player, you should leave the power switch in the "ON" position. When AC power is applied to the unit, it will power up in fully active mode.

12V Trigger Connection [14]

See Figure 3

The unit can be activated by a 12 volt trigger signal. The trigger input accepts any control signal (AC or DC) ranging from 3 volts to 30 volts. When a cable is connected to the 12V input and a trigger signal is present, the CD Player is activated. When the trigger signal is turned off, the unit goes into standby mode. The front panel power indicator will be red, but the display goes dark and the unit will not operate.

NOTE: When using the 12V Trigger feature, leave the POWER button in the ON position.

Output Connections

The CD14MKII unit gives you a choice of two different kinds of output connections — an analog output signal from the built-in D/A converter for use with conventional analog audio components and a coax digital output which provides an unprocessed digital data signal for use with outboard D/A converters or digital processors.

NOTE: To prevent loud noises that could damage your speakers, turn off all the system components when you make any signal connections.

Analog Outputs

See Figure 3

A pair of standard RCA jacks supplies an analog output signal from the CD14MKII unit to the source inputs of an audio preamplifier, integrated amplifier, or receiver.

Select high quality audio interconnect cables. Connect the left and right channel outputs of the unit to the corresponding inputs on the preamplifier or other component.

Digital Output

See Figure 3

If you are using an outboard D/A converter or other digital processor, you will need an unprocessed digital data stream from the CD14MKII. Using a standard 75 ohm coax digital cable, connect the CD14MKII's coax digital output to the digital input connector on the outboard D/A converter.

Operation

The unit can be operated using its front panel buttons or from corresponding buttons on the supplied infrared remote control. Specific instructions for each of these controls are detailed below. Most of the buttons are duplicated on the front panel and on the IR remote control. However, there are a few exceptions where the buttons are only available on one or the other. These exceptions are noted in the instructions.

Infrared Remote Control

Before using the IR remote control, it is necessary to install two "UM-4/AAA" batteries (supplied). Remove the plastic cover on the back of the IR remote, install the batteries (observing the + and - polarity indications), and reinstall the cover.

Display

A back-lit display on the front panel of the unit provides useful information about the status of the unit, activation of special features, and track/time information for the disc being played. Each of these indicators is described in the detailed operating instructions that follow.





Disc Tray

A motor-driven disc loading tray located in the center of the unit, accepts a compact disc. Press the eject button then place the disc into the tray, label-side up. Make sure the disc is properly centered before loading. The disc can be ejected by pressing the eject button again.

Transport Control Buttons



These buttons provide basic control functions for the disc transport mechanism. Except where noted, all functions are available on the unit front panel and the IR remote control.

EJECT Button





To open the tray loading mechanism press the EJECT button . The tray will open allowing the CD to be loaded label side up. To close the tray press the EJECT button  again.

If no disc is loaded when the tray is closed the display will read "No Disc". When a disc is loaded, the display will indicate the number of tracks on the disc and the total time of the disc in hours, minutes and seconds.



PLAY Button

After the disc is loaded, press the PLAY button  to start playing the disc. The number of the track being played and the elapsed time will be shown in the display, along with the PLAY indicator. Normally, the disc will start playing with the first track. However, you can select a different track using the TRACK buttons or the DIRECT ACCESS buttons (see below) before pressing the PLAY button  to start playing a different selection.



STOP Button

Press the STOP button  once to stop disc play. Press the PLAY button  to resume disc play where it was stopped. If the STOP button  is pressed twice, disc play stops, the display shows STOP indicator. When the PLAY button  is pressed after pressing the STOP button  twice, the disc begins playing from the first track or the first programmed track in PROGRAM mode (see below).

PAUSE Button

This button is used to temporarily suspend play. The disc continues to spin and play will be resumed from the current position. The PAUSE indicator will light in the display. To resume playing the disc, press the PAUSE button  again or press the PLAY button .

TRACK Buttons

These buttons are used to select tracks on the disc. When a disc is playing, pressing the TRACK button  advances to the beginning of the next track. Pressing the TRACK button  returns to the beginning of the current track. Pressing the TRACK button  twice quickly in succession returns to the beginning of the previous track. The new track number appears in the display.

These buttons are also used to select a track before pressing the PLAY button  or when memorizing tracks for the PROGRAM play mode (see below). These selections are made by continuously pressing the TRACK buttons until the desired track is reached.

In PROGRAM mode, the TRACK buttons advance or reverse to the next track in the memorized selection list.

DIRECT ACCESS Buttons

Remote Only

These ten numeric buttons (labelled 0 through 9) are used to directly access a track from the IR remote control instead of stepping through the tracks using the TRACK buttons.

The first nine tracks on a disc can be selected by pressing the corresponding button. For example, to play the third track, press the 3 button on the remote control.

When accessing track numbers greater than 9, enter the 2 digit track number on the remote control.

NOTE: The >10 button is not used for this model.

The number of the selected track will appear in the main numeric area at the center of the display.

SEARCH Button

Remote Only

These fast forward and fast reverse buttons ◀◀ / ▶▶ allow fast searching through the currently playing disc. One press of these buttons will fast forward or fast reverse at 2X normal speed. Pressing these buttons repeatedly will fast forward or fast reverse at 4X and 8X normal speed. Pressing the PLAY button returns the player to normal speed. While the fast search function is active, you will hear high-speed audio.

Additional Features

These convenience features add extra functionality to the CD14MKII, including the ability to memorize a group of tracks to be played, to repeat a disc, program, or track over and over, to play the tracks on a disc in random order, and to select from several available time displays.

PROGRAM Button

Remote Only

This button, labeled PROG, allows you to memorize as many as 20 tracks on the current disc for playback in a specific order. For example, you could instruct the CD14MKII to play track 5, followed by track 3, followed by track 8.

To begin a program:

1. Insert a disc into the tray loader. The CD14MKII will read the contents of the disc.
2. Press the PROG button on the remote control. The PROGRAM indicator will light up in the display, along with "PROG-01" indicating that the unit is waiting for the first track to be memorized.
3. Enter the first track number using the DIRECT ACCESS buttons. Your selection will be memorized automatically. Press PROG button again then the display indicator will change to "PROG-02". Continue entering the rest of your selections using the DIRECT ACCESS buttons.

Once you have memorized a play list, the CD14MKII remains in PROGRAM mode until you eject the disc or press and hold the PROG button for 3 seconds. If you press the PLAY button ▶, the memorized program will play instead of the entire disc, starting with the first selection in the memorized list.

When a PROGRAM has been memorized, most functions that would normally affect the entire disc operate on just the memorized program. For example, the TRACK buttons advance to the next track in the memorized program, not the next track on the disc. Likewise, the REPEAT button (see below) continuously plays the memorized program, not the entire disc.

NOTE: The Random button does not function when playing a program. To activate the Random button the unit must exit Program playback.

NOTE: Direct track access is not available when in the PROGRAM mode.

RANDOM Button

Remote Only

This instructs the CD player to play tracks from the entire disc in random order. Once all of the selections have been played once, the disc will stop playing, unless the REPEAT Button (see below) has been engaged, in which case the random play will continue until the STOP button ■ is pressed.

REPEAT Button

Remote Only

This button allows you to repeat the current track or the entire disc continuously until the feature is cancelled by disengaging the REPEAT button or pressing the STOP button ■. The REPEAT button steps sequentially through the available options. Press the button once and the CD14MKII will repeat just the current track. Press the button a second time and the CD14MKII will repeat the entire disc. Press the button a third time to cancel the REPEAT function.

As noted above, REPEAT can be used in conjunction with the RANDOM play feature.

NOTE: The REPEAT function is automatically cancelled when the disc is ejected.

TIME Button

Remote Only

Normally, the CD14MKII displays the elapsed time of the currently playing track. The TIME button allows you to step through two alternative time displays. Pressing the button once displays the time remaining in the current track, which counts down as the track continues playing. Pressing the button a second time displays the time remaining on the entire disc (or memorized program). Pressing the button a third time reverts to the standard elapsed time display.

NOTE: If a disc has CD Text information on it, pressing the play button during playback will alternate between standard disc information and any CD Text data being shown on the display.

RS232

The unit can be controlled via RS232 for integration with automation systems. The RS232 input accepts a standard straight DB-9 Male-to-Female cable.

For additional information on the connections, software, and operating codes for RS232 control of the CD14MKII, contact your authorized Rotel dealer.

Rotel Link

Rotel Link is not used for CD14MKII.

Remote Control Advanced Buttons

MENU Button

Remote Only

By pressing the MENU button, you can enter the following setup menu:

- DISPLAY DIMMER: Changes the display brightness.
- POWER LED DIMMER: Changes the Power LED brightness.

NOTE: *These settings are stored permanently even after the CD14MKII is powered off.*

- VERSION: Shows the current software version.
- AUTO POWER OFF: The unit can be configured to automatically power off if unused for a specified period. If the CD is stopped for the specified "Auto Power Off" time the unit will automatically go to STANDBY mode. The Auto Power Off timer will be restarted if the CD starts to play. The default for Auto Power Off is set to 20 MINS.

Valid settings include: 20 MINS, DISABLE, 30 mins, 60 mins, 90 mins.

- EXIT: Exits this SETUP menu.

From the remote control, press the up/down arrow buttons to change the contents of the menu, and press ENT to enter the settings or confirm.

NOTE: *You can also access the SETUP menu without the remote control. Press the STOP button on the front panel for 5~10 seconds. Press the TRACK buttons to change the contents of the menu and press STOP button to enter the settings or confirm.*

DIM Button

Remote Only

Press the DIM button sequentially to change the DISPLAY brightness.

NOTE: *Adjustments made using the  button are temporary only and not saved after powering off the CD14MKII.*

Troubleshooting

Most difficulties in audio systems are the result of incorrect connections, or improper control settings. If you encounter problems, isolate the area of the difficulty, check the control settings, determine the cause of the fault and make the necessary changes. If you are unable to get sound from the unit, refer to the suggestions for the following conditions:

Power Indicator Is Not Illuminated

The Power Indicator and the basic items in the display window should be illuminated whenever the unit is plugged into the wall power outlet and the Power button is pushed in. If it does not light, test the power outlet with another electrical device, such as a lamp. Be sure the power outlet being used is not controlled by a switch that has been turned off.

Fuse Replacement

If another electrical device works when plugged into the power outlet, but the Power Indicator and the display still will not light when the unit is plugged into the wall outlet, it indicates that the internal power fuse may have blown. If you believe this has happened, contact your authorized Rotel dealer to get the fuse replaced.

No Sound

Check the cables between the unit and the amplifier inputs to be sure they are connected properly. Be sure the correct amplifier input is selected. Be sure the tape monitor system of the amplifier has not been activated. Check the wiring between the amplifier and the speakers.

Specifications

Total Harmonic Distortion + Noise	0.0035% @ 1 kHz
Intermodulation Distortion	0.0035% @ 1 kHz
Frequency Response (± 0.5 dB)	20 - 20,000 Hz
Channel Balance	± 0.5 db
Phase Linearity	± 0.5 degree
Channel Separation	> 118 dB @ 10 kHz
Signal to Noise Ratio (<i>A weighting</i>)	> 118 dB
Dynamic Range	> 99 dB
Digital to Analog Converters	Texas Instruments
Analog Output impedance	100 Ohms
Digital Output	0.5 Volt, Peak to Peak
Load Impedance	75 Ohms
Power Requirements (<i>AC</i>)	
USA	120V, 60 Hz
EC	230V, 50 Hz
Power Consumption	15 Watts
Standby Power Consumption	< 0.5 Watts
Dimensions (<i>W, H, D</i>)	430 x 98 x 314 mm 17" x 3 ⁷ / ₈ " x 12 ³ / ₈ "
Front Panel Height	80 mm / 3 ¹ / ₈ "
Weight (<i>net</i>)	6.51 kgs, 14.35 lbs.

All specifications are accurate at the time of printing. Rotel reserves the right to make improvements without notice.

Rotel and the Rotel HiFi logo are registered trademarks of The Rotel Co., Ltd. Tokyo, Japan.

The Rotel Co. Ltd.

Tachikawa Bldg. 1F.,
2-11-4, Nakane, Meguro-ku,
Tokyo, 152-0031
Japan

Rotel USA

Sumiko
11763 95th Avenue North
Maple Grove, MN 55369
USA
Phone: (510) 843-4500 (option 2)
E-mail: Rotelsupport@sumikoaudio.net

Rotel Canada

Kevro International
902 McKay Rd. Suite 4
Pickering, ON L1W 3X8
Canada
Tel: +1 905-428-2800

Rotel Europe

Dale Road
Worthing, West Sussex BN11 2BH
England
Phone: + 44 (0)1903 221 710
Fax: +44 (0)1903 221 525

www.rotel.com

