

QUICK REFERENCE GUIDE

WHIRLPOOL® TOP LOADING WASHING MACHINE

CONTROL PANEL AND FEATURES

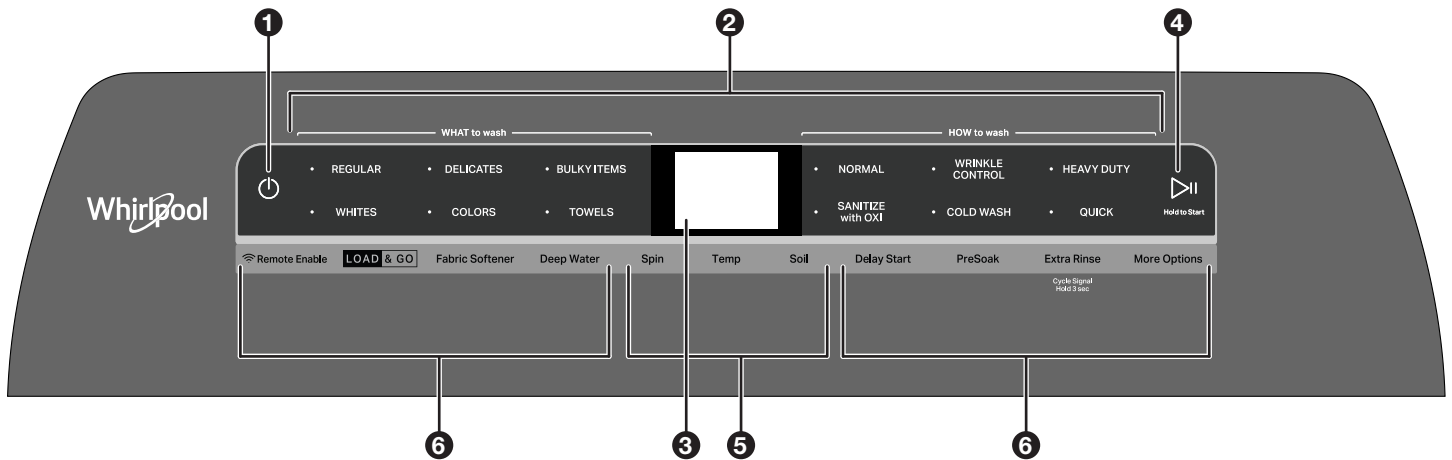

Appearance may vary depending on model.

1 POWER

Touch to turn on/off or to stop/cancel a cycle.

2 WHAT TO WASH/HOW TO WASH

First select a cycle from the “What to Wash” and then select the “How to Wash” to get the best combination cycle available for the type of items you are going to wash. See “Cycle Guide” for cycle details.

3 LCD TIME/STATUS DISPLAY

The display shows the time required for the cycle to complete. Factors such as load size and water pressure may affect the time shown in the display. Tightly packed loads, unbalanced loads, or excessive suds may cause the washer to adjust the cycle time as well.

If you have set a delay start to the cycle, the display will show the delay time adjusted.

ADD GARMENT

When Add Garment is lit, you may pause the cycle, open the lid, and add items. Touch and hold the START/PAUSE button to start the cycle again.

4 START/PAUSE

Touch and hold the START/PAUSE to start cycle. Touch during a cycle to pause cycle and unlock lid.

NOTE: If machine is spinning it may take longer to unlock lid.

5 CYCLE MODIFIERS (Not all modifiers are available on all cycles)

SPIN

Touch to modify the cycle’s available spin speeds (Off, Medium, Fast).

TEMP

Touch to modify the cycle’s available water temperatures (Tap Cold, Cold, Cool, Warm, Hot).

SOIL

Touch to modify the cycle’s available soil levels. Increase soil level for heavily soiled items and decrease soil level for lightly soiled items (Extra Light, Light, Normal, Heavy, Extra Heavy).

6 CYCLE OPTIONS (Not all options are available on all cycles)

REMOTE ENABLE

Touch each time you want to remotely control via the Whirlpool® app. Follow the instructions in the “get the Whirlpool® app and get connected” section below for more details. Opening the lid cancels “remote enable”.

LOAD & GO™ Bulk Dispenser

The Load & Go™ dispenser holds 1L of detergent and determines the best time and amount to add detergent to the load. See “Using the Dispensers” section for more information.

FABRIC SOFTENER

Touch “Fabric Softener” button to let the machine know when you have added fabric softener to the appropriate dispenser.

DEEP WATER

Touch “Deep Water” button to add more water to the washer from the cycle’s auto sensed level (Auto, Medium, High, Max Fill).

NOTE: Expect longer cycle times due to extended fill times when using the Deep Water option.

DELAY START

Touch to delay the start of the wash cycle for up to 12 hours.

PRESOAK

Touch to add a presoak period to any cycle to help loosen tough stains. The washer will fill, pause to soak, and then begin the selected cycle (15 mins, 30 mins, 60 mins, 120 mins).

EXTRA RINSE

Touch to automatically add a second rinse available on most cycles.

CYCLE SIGNAL

Touch to turn the end of cycle signal on/off and adjust the tone volume when a button is touched.

MORE OPTIONS

- Drain & Spin
- Rinse & Spin
- Clean Washer with affresh®
- Favorite Cycle

GET THE WHIRLPOOL® APP AND GET CONNECTED



With your mobile device download the Whirlpool® app. You can get subscription and connectivity instructions, terms of use, and privacy policy at www.whirlpool.com/connect or in Canada www.whirlpool.ca/connect.

Once installed, launch the app and you will be guided through the steps to subscribe and create your user account to connect to your appliance. If you have any problems or questions, call Whirlpool® Connected Appliances at **1-866-333-4591**.

1 CONNECTING UNIT TO INTERNET

To connect your unit to the internet please download the Whirlpool® App and press REMOTE ENABLE.

2 ALLOWING REMOTE CONTROL AND INTERACTION

User must press REMOTE ENABLE when connected in order to allow remote control and interaction.

USING YOUR WASHER

⚠ WARNING

Fire Hazard

Never place items in the washer that are dampened with gasoline or other flammable fluids.

No washer can completely remove oil.

Do not dry anything that has ever had any type of oil on it (including cooking oils).

Doing so can result in death, explosion, or fire.

1 SORT & LOAD LAUNDRY

See Loading Recommendation section below.

2 ADD HE DETERGENT & LAUNDRY PRODUCTS TO DISPENSERS*

Dispenser Drawer

Bulk Dispenser

Remove inside tray for powder HE detergent.

3 TOUCH POWER TO TURN ON THE WASHER

4 SELECT THE DESIRED CYCLE FOR YOUR LOAD*

5 ADJUST CYCLE SETTINGS, IF DESIRED*

6 SELECT ADDITIONAL OPTIONS*

7 TOUCH AND HOLD START/PAUSE TO BEGIN CYCLE

***NOTE:** Not all cycles, settings or options are available with all models.

LOADING RECOMMENDATION



For best performance, it is recommended to load items by dropping them in loose heaps evenly around the washplate and agitator. Do not lay items length-wise around the washplate or agitator.

PRETREATING BEFORE RUNNING A WASH CYCLE

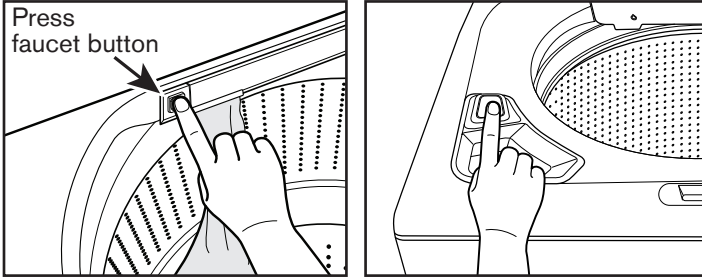

Water Faucet Operation

- Press the faucet button once to turn on and press again to turn off.
- Faucet will automatically shut off after 10 minutes or when max water level is reached.
- Water will automatically drain if water level becomes too high or if the lid is left open for 10 minutes.
- On Load & Go™ models when the faucet is on touch TEMP button to select water temperature or touch LOAD & GO button to manually dispense a dose of detergent.

USING THE PRETREAT FABRIC BRUSH

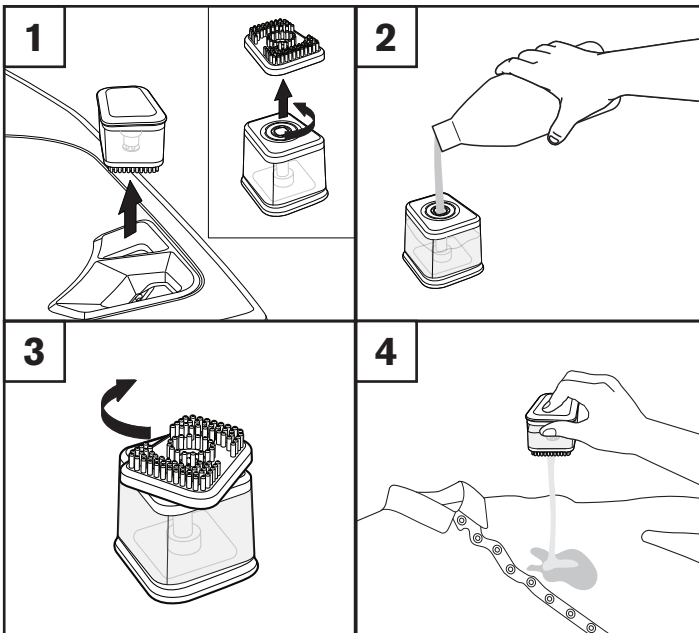

1. Turn brush from body to open.
2. Add liquid laundry detergent.
3. Turn to close.
4. To dispense detergent from fabric brush, push button.

WARNING: Do not wash water-resistant or water repellent-type clothing. Failure to closely follow these instructions may result in an abnormal vibrating and out-of-balance condition that could result in physical injury, property damage and/or appliance damage.

MORE WATER WHEN YOU WANT IT

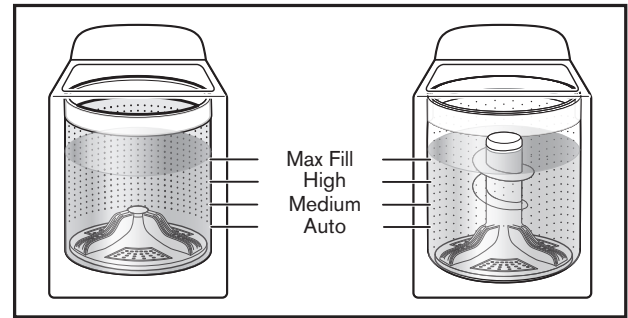

Auto Sensing & Deep Water Wash

- The washer has been designed and optimized to provide a thorough cleaning using less water to conserve energy and resources. The washer will automatically adjust the water level to the optimal amount for a High Efficiency wash of the detected load size.
- Touch “DEEP WATER” to add more water to the wash load.
- There are four levels of deep water “Auto”, “Medium”, “High”, “Max Fill”.
- Not all levels are available on all cycles.
- As the washer dampens and moves the load, the level of the items will settle in the basket. This is normal, and does not indicate that more items should be added.

IMPORTANT: You will not see a full basket of water as with older, less efficient washing machines. It is normal for some of the load to be above the water line.

USING THE DISPENSER*

- Load & Go™ feature will default On for each cycle unless disabled.
- Touch LOAD & GO button to view detergent dispensing options.
- Hold LOAD & GO button on the control panel to choose a detergent concentration between 2X and 10X. Hold for 3 seconds.
- Pull the drawer completely out for easy refilling.

*On models equipped with Load & Go Dispenser Drawer.

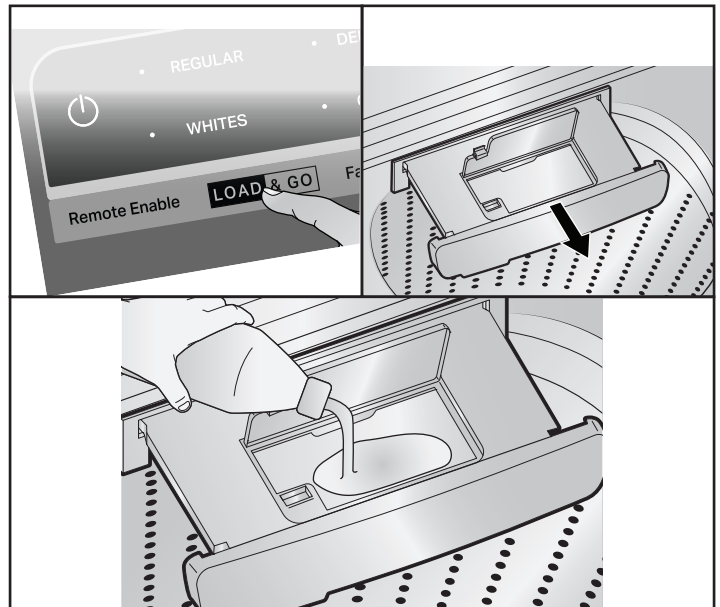

CYCLE GUIDE

Your Whirlpool® washer has a unique user interface to help you select the best cycle you need for your load. The “What to Wash”, “How to Wash” layout guides you to the optimal cycle in two easy steps:

First determine what items are in the load that you are trying to wash. Use that to guide your “What to Wash” selection. Then determine how you want the washer to wash them and select the appropriate “How to Wash” selection. See chart below for more details.

For best fabric care, choose the cycle that best fits the load being washed.

R – Recommended Cycle

a – Alternate Cycle

Blank – Cycle is available but not optimal

		How do you want to wash?					
		“How to Wash” Cycle Selection					
		Normal	Wrinkle Control	Heavy Duty	Sanitize with Oxi	Cold Wash	Quick
		Energy Conscious	Reduce Wrinkles	Powerful Soil Removal	Eliminate Bacteria*	Energy Saving	Fast
What do you want to wash?	“What to Wash” Cycle Selection						
Cottons/Linens	Regular	R	a	a	a	a	a
Mixed		R	a	a	a	a	a
Pajamas		R	a	a	a	a	a
Sweatshirts		R	a	a	a	a	a
T-Shirts		R	a	a	a	a	a
Athletic Wear	Colors	R	a	a	a	a	
Bright Colors		R	a	a	a	a	a
Business Casual		a	R	a	a	a	a
Casuals		a	R	a	a	a	a
Dark Colors		R	a	a	a	a	a
Dress Shirts/Pants		a	R	a	a	a	a
Jeans		R	a	a	a	a	a
No-Iron Fabrics	a	R	a	a	a	a	
Baby Clothes	Whites	R	a	a	a		
Handkerchiefs		R	a	a	a		a
Napkins		R	a	a	a		a
Socks		R	a	a	a		a
Tablecloth		R	a	a	a	a	a
Undergarments		R	a	a	a	a	a
White Clothing		R	a	a	a		a
White Shirts		R	a	a	a		a
White Towels		R	a	a	a		a
White T-Shirts		R	a	a	a		a
Bras	Delicates	R	a	a	a	a	a
Delicates		R	a	a	a	a	a
Handwash Fabrics		R	a	a	a	a	a
Lingerie		R	a	a	a	a	a
Machine Wash Silks		R	a	a	a	a	a
Wool		R	a	a	a	a	a
Blankets	Bulky Items	R	a	a	a	a	a
Coats & Jackets		R	a	a	a	a	a
Comforters		R	a	a	a		a
Machine Wash Curtains		R	a	a	a	a	a
Machine Wash Slip Covers		R	a	a	a		a
Non-Rubber Lined Rugs & Mats		R	a	a	a		a
Sheets		R	a	a	a		a
Sleeping Bags		R	a	a	a		a
Dish Cloths	Towels	R	a	a	a		a
Terry Cloths		R	a	a	a		a
Towels		R	a	a	a		a

*Use this cycle to eliminate 99.9% of bacteria when used in conjunction with Oxi additives. Preset cycle settings must be used to achieve proper sanitization. Be sure to add an Oxi product to the basket before starting cycle.

WASHER ICONS



































Image	Description	Status
	Door Locked	Alert State
	Load & Go Warning	Off One Cycle
		Off Always
		Detergent Low
		Remote Enable
	Delay Start	On
	PreSoak	On
	Deep Water	On - Auto
		On - Auto Medium
		On - Auto High
		On - Max Fill
		Fabric Softener
	Extra Rinse	On
	Load & Go	50%
		75%
		Full
		

Image	Description	Status
	Smartgrid, Peak rates in effect	On
		Smart Delay
		Smart Pause
	WiFi Status Indicator	Connected
		Disconnected
	Fabric Softener	Off
	Extra Rinse	Off
	PreSoak	Off
	Favorite Cycle	
	Download & Go Cycle	
	Cycle Signal	Off
		Low
		Medium
		High
	Clean Washer	
	Remote Enable	Off
	Faucet	On
		Off







NOTE: Not all features and options are available on all models.

ASSISTANCE OR SERVICE AND ADDITIONAL INFORMATION

For detailed installation instructions and maintenance information, winter storage and transportation, please see the **INSTALLATION AND CARE INSTRUCTIONS MANUAL** included with your machine.

For detailed product dimensions, please see the **DIMENSION GUIDE** that can be found at www.whirlpool.com/owners or in Canada www.whirlpool.ca/owners.

For information on any of the following items please visit www.whirlpool.com/owners or in Canada www.whirlpool.ca/owners. This may save you the cost of a service call.

REGISTER PRODUCT	SCHEDULE SERVICE	HOW TO'S & FAQ	MANUALS & DOWNLOADS	ADD SERVICE PLAN	PARTS	ACCESSORIES
						

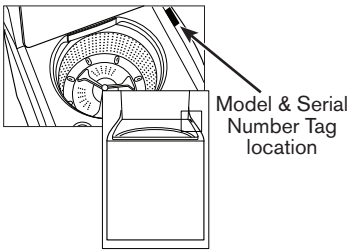

To speak with a customer service representative or if you have additional questions, call us toll free at **1-866-698-2538** or in Canada call **1-800-688-2002**.

You can write with any questions or concerns at:

Whirlpool Brand Appliances
Customer eXperience Center
533 Benson Road
Benton Harbor, MI 49022-2692

Whirlpool Brand Appliances
Customer eXperience Center
Unit 200-6750 Century Ave
Mississauga, Ontario L5N 0B7

Please include a daytime phone number in your correspondence.

GUIDE DE RÉFÉRENCE RAPIDE LAVEUSE CHARGEMENT PAR LE DESSUS WHIRLPOOL®

TABLEAU DE COMMANDE ET CARACTÉRISTIQUES

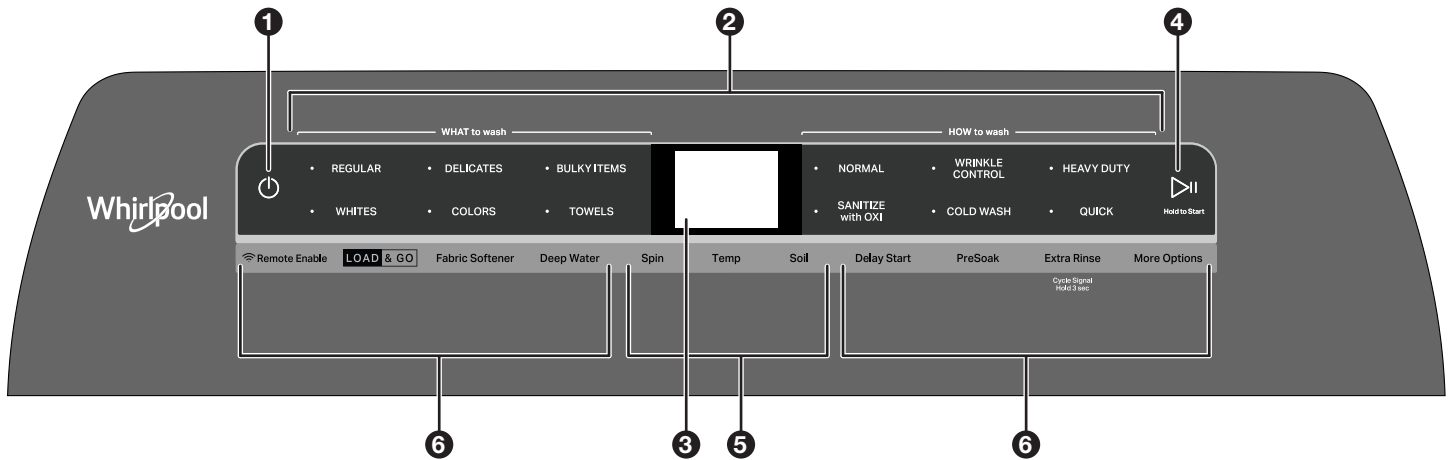

L'aspect peut varier en fonction du modèle.

1 POWER (alimentation)

Toucher pour activer/désactiver ou pour arrêter/annuler un programme.

2 WHAT TO WASH/HOW TO WASH (ARTICLES À LAVER/MÉTHODE DE LAVAGE)

Sélectionner d'abord un programme, dans la partie «What to Wash» (articles à laver), puis sélectionner un programme dans la partie «How to Wash» (méthode de lavage) pour obtenir la meilleure combinaison de programmes disponibles pour le type d'articles à laver. Voir le «Guide de programmes» pour plus de détails.

3 AFFICHEUR ACL DE DURÉE/STATUT

L'afficheur indique le temps nécessaire à l'achèvement du programme. Des facteurs tels que la taille de la charge et la pression de l'eau peuvent affecter la durée affichée. La laveuse peut également ajuster la durée du programme si le linge est tassé dans la charge, la charge est déséquilibrée ou si la mousse produite est excessive.

Si une mise en marche différée a été programmée, l'affichage indiquera la durée différée réglée.

ADD GARMENT (ajouter un vêtement)

Lorsque Add Garment (ajouter un vêtement) est allumé, on peut suspendre le programme, ouvrir le couvercle et ajouter des articles. Toucher et maintenir enfoncé le bouton START/PAUSE (MISE EN MARCHÉ/PAUSE) pour redémarrer le programme.

4 START/PAUSE (mise en marche/pause)

Toucher et maintenir enfoncé le bouton START/PAUSE (MISE EN MARCHÉ/PAUSE) pour démarrer le programme. Toucher ce bouton pendant un programme pour mettre un programme en pause et déverrouiller le couvercle.

REMARQUE : Si la laveuse essore, le déverrouillage du couvercle peut prendre quelque temps.

5 MODIFICATEURS DE PROGRAMME (Les modificateurs ne sont pas tous disponibles avec tous les programmes)

SPIN (essorage)

Toucher ce bouton pour modifier les vitesses d'essorage disponibles du programme (Off [désactivée], Medium [moyenne], Fast [élevée])

TEMP (température)

Toucher ce bouton pour modifier les températures d'eau disponibles du programme (Tap Cold [froide du robinet], Cold [froide], Cool [fraîche], Warm [tiède], Hot [chaude])

SOIL (sauté)

Toucher ce bouton pour modifier les degrés de saleté disponibles du programme. Choisir un degré de saleté élevé pour les articles très sales et choisir un degré de saleté inférieur pour les articles légèrement sales (Extra Light [peu sale], Light [légèrement sale], Normal [quantité normale de saleté], Heavy [très sale], Extra Heavy [excessivement sale]).

6 OPTIONS DE PROGRAMME (Les options ne sont pas toutes disponibles avec tous les programmes)

REMOTE ENABLE (activation à distance)

Toucher ce bouton chaque fois pour activer la commande à distance via l'application Whirlpool®. Suivre les instructions dans la section «obtenir l'application Whirlpool® et se connecter» ci-après. Ouvrir le couvercle annule Remote Enable (activation à distance).

Distributeur LOAD & GO™

Le distributeur Load & Go™ peut contenir 1 L de détergent et détermine le meilleur moment et la meilleure quantité pour ajouter du détergent à la charge. Consulter la section «Utilisation du distributeur» pour plus de renseignements.

FABRIC SOFTENER (assouplissant)

Toucher le bouton «Fabric Softener» (assouplissant) pour informer la machine lors de l'ajout de l'assouplissant dans le distributeur approprié.

DEEP WATER (niveau d'eau élevé)

Toucher le bouton «Deep Water» (niveau d'eau élevé) pour ajouter plus d'eau à la laveuse à partir du niveau détecté automatiquement du programme (Auto [automatique], Medium [moyen], High [élevé], Max Fill [remplissage maximum]).

REMARQUE : Le programme prendra plus de temps à s'exécuter en raison du temps de remplissage supplémentaire occasionné par l'option Deep Water (niveau d'eau élevé).

DELAY START (mise en marche différée)

Toucher ce bouton pour différer le démarrage d'un programme de lavage jusqu'à 12 heures.

PRESOAK (prétrempage)

Toucher ce bouton pour ajouter une période de prétrempage à un programme de lavage afin d'aider à décoller les taches. La laveuse se remplit, se met en pause pour le trempage des vêtements, puis démarre le programme sélectionné (15 minutes, 30 minutes, 60 minutes, 120 minutes).

EXTRA RINSE (rinçage supplémentaire)

Toucher ce bouton pour ajouter automatiquement un deuxième rinçage disponible sur la plupart des programmes.

CYCLE SIGNAL (signal de programme)

Toucher ce bouton pour activer/désactiver le signal de fin de programme et régler le volume du signal sonore lorsqu'un bouton est touché.

MORE OPTIONS (autres options)

- Drain & Spin (vidange et essorage)
- Rinse & Spin (rinçage et essorage)
- Clean Washer with affresh® (nettoyage de la laveuse avec affresh®)
- Favorite cycle (programme préféré)

OBTENIR L'APPLICATION WHIRLPOOL® ET SE CONNECTER



Téléchargez l'application Whirlpool® sur votre appareil mobile. Vous pouvez obtenir les instructions d'abonnement et de connectivité, les conditions d'utilisation et la politique de confidentialité à l'adresse www.whirlpool.com/connect ou www.whirlpool.ca/connect si vous résidez au Canada.

Une fois installée, lancez l'application et vous devez suivre les étapes pour vous abonner et créer votre compte utilisateur pour vous connecter à votre appareil. Si vous avez des problèmes ou des questions, appelez Whirlpool® Connected Appliances au 1-866-333-4591.

1 CONNEXION DE L'APPAREIL A L'INTERNET

Pour connecter l'appareil à l'Internet, téléchargez l'application Whirlpool® et appuyez sur REMOTE ENABLE (activation à distance).

2 AUTORISER LA COMMANDE ET L'INTERACTION A DISTANCE

L'utilisateur doit appuyer sur REMOTE ENABLE (activation à distance) une fois connecté afin de permettre la commande et l'interaction à distance.

UTILISATION DE LA LAVEUSE

⚠ AVERTISSEMENT

Risque d'incendie

Ne jamais mettre des articles humectés d'essence ou d'autres fluides inflammables dans la laveuse.

Aucune laveuse ne peut complètement enlever l'huile.

Ne pas faire sécher des articles qui ont été salis par tout genre d'huile (y compris les huiles de cuisson).

Le non-respect de ces instructions peut causer un décès, une explosion ou un incendie.

1 TRIER ET CHARGER LES VÊTEMENTS

Voir la section Recommandations concernant le chargement ci-dessous.

2 AJOUTER DU DÉTERGENT ET DES PRODUITS DE LESSIVE DANS LES DISTRIBUTEURS*

Tiroir du distributeur
Retirer le plateau interne pour le détergent HE en poudre.

Distributeur de vrac

3 TOUCHER LE BOUTON POWER (ALIMENTATION) POUR METTRE LA LAVEUSE SOUS TENSION

4 SÉLECTIONNER LE PROGRAMME SOUHAITÉ POUR LA CHARGE*

5 AJUSTER LES RÉGLAGES DE PROGRAMME SI DÉSIRÉ

6 SÉLECTIONNER LES OPTIONS SUPPLÉMENTAIRES*

7 TOUCHER ET MAINTENIR ENFONCÉ LE BOUTON START/PAUSE (mise en marche/pause) POUR DÉMARRER LE PROGRAMME

*REMARQUE : Les programmes, réglages ou options ne sont pas tous offerts sur tous les modèles.

RECOMMANDATIONS CONCERNANT LE CHARGEMENT



Pour un meilleur rendement, il est recommandé de charger les articles en les déposant en vrac et de façon uniforme autour du plateau de lavage et de l'agitateur. Ne pas déposer les articles sur toute leur longueur autour du plateau de lavage ou de l'agitateur.

PRÉTRAITEMENT AVANT DE FAIRE FONCTIONNER LE PROGRAMME DE LAVAGE

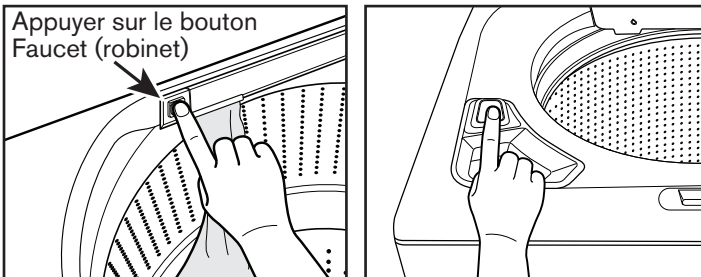

Fonctionnement du robinet d'eau

- Appuyer sur le bouton de robinet une fois pour ouvrir le robinet, appuyer de nouveau pour le fermer.
- Le robinet se ferme automatiquement après 10 minutes ou lorsque le niveau maximum d'eau est atteint.
- L'eau se vide automatiquement si le niveau d'eau devient trop élevé ou si le couvercle reste ouvert pendant 10 minutes.
- Sur les modèles avec distributeur Load & Go™, lorsque le robinet est ouvert, toucher le bouton TEMP (température) pour sélectionner la température de l'eau ou toucher le bouton LOAD & GO pour distribuer manuellement une dose de détergent.

UTILISATION DE LA BROSSÉ À TISSU DE PRÉTRAITEMENT

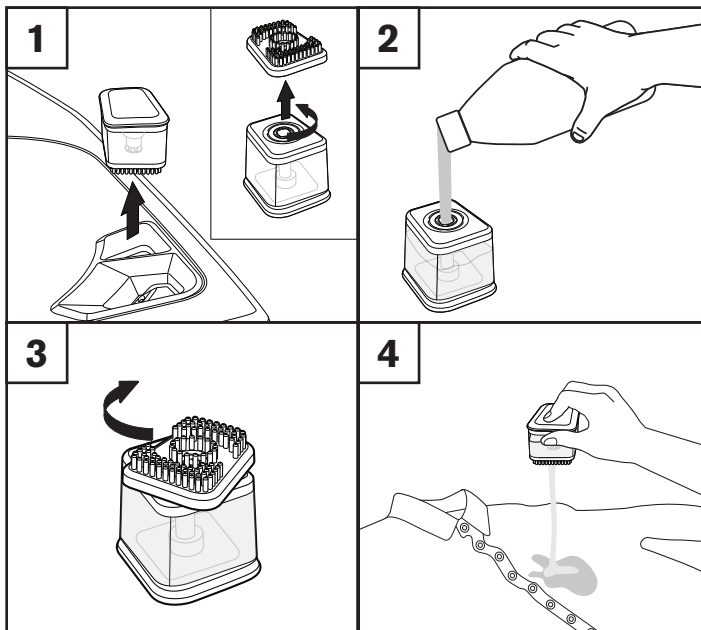

1. Tourner la brosse sur le compartiment pour l'ouvrir.
2. Verser le détergent liquide pour lessive.
3. Tourner pour fermer le compartiment.
4. Pour distribuer du détergent à partir de la brosse à tissu, appuyer sur le bouton.

AVERTISSEMENT : Ne pas laver de vêtements résistants à l'eau ou de type hydrofuge. Le non-respect de ces instructions peut entraîner une vibration anormale et un déséquilibre pouvant entraîner des blessures, des dommages matériels voire des dommages à l'appareil.

PLUS D'EAU LORSQUE VOUS EN AVEZ BESOIN

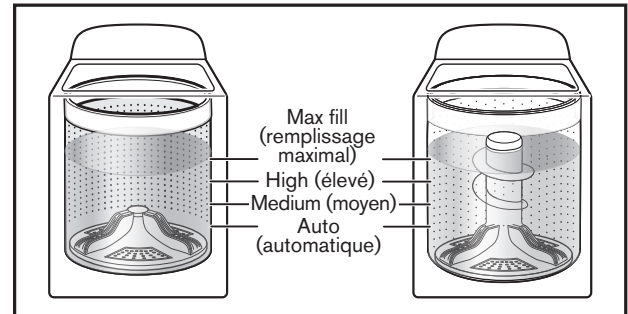

Détection automatique et lavage Deep Water (grand remplissage)

- La laveuse a été conçue et optimisée pour fournir un nettoyage en profondeur en utilisant moins d'eau afin d'économiser l'énergie et les ressources. La laveuse règle automatiquement le niveau d'eau pour utiliser la quantité optimale nécessaire pour laver avec grande efficacité la charge détectée.
- Toucher « DEEP WATER » (grand remplissage) pour ajouter plus d'eau à la charge de lavage.
- Il y a quatre niveaux d'eau élevés « Auto » (automatique), « Medium » (moyen), « High » (élevé), « Max Fill » (remplissage maximum).
- Les niveaux ne sont pas tous disponibles sur tous les programmes.
- À mesure que la laveuse imbibe et déplace la charge, les articles se tassent dans le panier. Ceci est normal et ne signifie pas que l'on doit rajouter des articles.

IMPORTANT : Il n'y aura pas de panier d'eau plein comme avec les machines à laver plus anciennes et moins efficaces. Il est normal qu'une partie de la charge dépasse du niveau d'eau.

UTILISATION DU DISTRIBUTEUR*

- Le distributeur Load & Go™ est activé par défaut pour chaque programme, sauf s'il est désactivé.
- Toucher le bouton LOAD & GO pour afficher les options de distribution de détergent.
- Maintenir enfoncé le bouton LOAD & GO sur le tableau de commande pour choisir une concentration de détergent comprise entre 2X et 10X. Maintenir enfoncé pendant 3 secondes.
- Tirer le tiroir complètement ouvert pour le remplir facilement.

*Sur les modèles équipés du tiroir distributeur Load & Go.

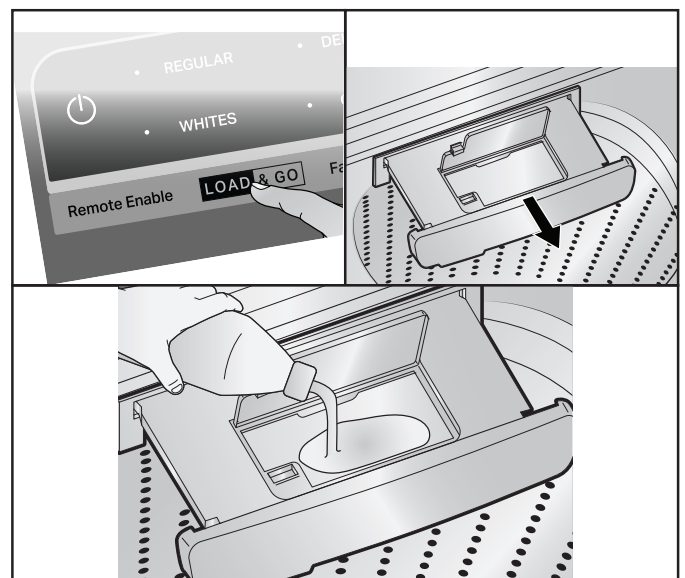

GUIDE DES PROGRAMMES

Cette laveuse Whirlpool® possède une interface utilisateur unique pour aider l'utilisateur à sélectionner le programme le mieux adapté à la charge. Les configurations «What to Wash» (articles à laver) et «How to Wash» (méthode de lavage) indiquent le programme idéal en deux étapes faciles : Déterminer d'abord les articles dans la charge qui doit être lavée. Sélectionner ainsi les articles adéquats dans la partie «What to Wash» (articles à laver). Ensuite, déterminer la manière dont on souhaite nettoyer ces articles et sélectionner la méthode appropriée dans la partie «How to Wash» (méthode de lavage). Voir le tableau ci-dessous pour plus de détails.

Pour un meilleur soin des tissus, choisir le programme qui convient le mieux à la charge à laver.

R – Programme recommandé

a – Programme alternatif

Case vide – Programme disponible, mais pas optimal.

		Quelle méthode de lavage souhaite-t-on utiliser?					
		Sélection du programme «How to Wash» (méthode de lavage)					
		Normal	Wrinkle Control (commande antifrôissement)	Heavy Duty (service intense)	Sanitize with Oxi (assainissement avec Oxi)	Cold Wash (lavage à l'eau froide)	Quick (rapide)
		Éconergétique	Réduire les plis	Détachage puissant	Éliminer les bactéries*	Économie d'énergie	Rapide
Quels articles souhaite-t-on laver?	Sélection du programme «What to Wash» (articles à laver)						
Coton/lin	Regular (ordinaire)	R	a	a	a	a	a
Mélangés		R	a	a	a	a	a
Pyjamas		R	a	a	a	a	a
Hauts de survêtements		R	a	a	a	a	a
T-shirts		R	a	a	a	a	a
Vêtements de sport	Colors (Couleurs)	R	a	a	a	a	a
Couleurs vives		R	a	a	a	a	a
Tenues de bureau décontractées		a	R	a	a	a	a
Tout-aller		a	R	a	a	a	a
Couleurs foncées		R	a	a	a	a	a
Chemises et pantalons habillés		a	R	a	a	a	a
Jeans		R	a	a	a	a	a
Tissus infroissables	a	R	a	a	a	a	
Vêtements pour bébé	Whites (blancs)	R	a	a	a	a	a
Mouchoirs		R	a	a	a	a	a
Serviettes de table		R	a	a	a	a	a
Chaussettes		R	a	a	a	a	a
Nappe		R	a	a	a	a	a
Sous-vêtements		R	a	a	a	a	a
Vêtements blancs		R	a	a	a	a	a
Chemises blanches		R	a	a	a	a	a
Serviettes blanches		R	a	a	a	a	a
T-Shirts blancs		R	a	a	a	a	a
Soutiens-gorge	Delicates (vêtements délicats)	R	a	a	a	a	a
Vêtements délicats		R	a	a	a	a	a
Tissus lavables à la main		R	a	a	a	a	a
Lingerie		R	a	a	a	a	a
Articles en soie lavables en machine		R	a	a	a	a	a
Lainages		R	a	a	a	a	a
Couvertures	Bulky Items (articles volumineux)	R	a	a	a	a	a
Manteaux et vestes		R	a	a	a	a	a
Douillettes		R	a	a	a	a	a
Rideaux lavables en machine		R	a	a	a	a	a
Housses lavables en machine		R	a	a	a	a	a
Tapis et paillassons sans garniture de caoutchouc		R	a	a	a	a	a
Draps		R	a	a	a	a	a
Sacs de couchage		R	a	a	a	a	a
Torchons de vaisselle	Towels (serviettes)	R	a	a	a	a	a
Tissu éponge		R	a	a	a	a	a
Serviettes		R	a	a	a	a	a

*Utiliser ce programme pour éliminer 99,9 % des bactéries lorsqu'il est utilisé en conjonction avec des additifs Oxi. On doit utiliser les préréglages de programme pour un assainissement correct.

Veiller à ajouter un produit Oxi au panier avant de démarrer le programme.

ICÔNES DE LA LAVEUSE



































Image	Description	État
	Door locked (porte verrouillée)	Alert State
	Load & Go Warning (avertissement Load & Go)	Off One Cycle
		Off Always
		Detergent Low
		Remote Enable (activation à distance)
	Delay Start (mise en marche différée)	On (activé)
	Presoak (prétrempage)	On (activé)
	Deep Water (niveau d'eau élevé)	On - Auto (activé - automatique)
		On - Auto Medium (activé - automatique moyen)
		On - Auto High (activé - automatique élevé)
		On - Max Fill (activé - remplissage maximal)
		Fabric Softener (assouplissant)
	Extra Rinse (rinçage supplémentaire)	On (activé)
	Load & Go	50%
		75%
		Full

Image	Description	État
	Smartgrid, Peak rates in effect (Smartgrid, plein tarif activé)	On (activé)
		Smart Delay (mise en marche différée intelligente)
		Smart Pause (mise en pause intelligente)
	WiFi Status Indicator (Indicateur d'état de la WiFi)	Connected (connecté)
		Disconnected (déconnecté)
	Fabric Softener (assouplissant)	Off (désactivé)
	Extra Rinse (rinçage supplémentaire)	Off (désactivé)
	Presoak (prétrempage)	Off (désactivé)
	Favorite Cycle (programme préféré)	
	Download & Go Cycle (Programme Download & Go)	
	Cycle Signal (signal de programme)	Off (désactivé)
		Low (bas)
		Medium (moyen)
		High (élevé)
	Clean Washer (nettoyage de la laveuse)	
	Remote Enable (activation à distance)	Off (désactivé)
	Faucet (robinet)	On (activé)
		Off (désactivé)





REMARQUE: Les programmes et options ne sont pas tous disponibles sur tous les modèles.

ASSISTANCE OU SERVICE ET INFORMATIONS SUPPLÉMENTAIRES

Pour obtenir des instructions détaillées pour l'installation, l'entretien, l'hivernisation, ainsi que des conseils de transport, consultez le MANUEL D'INSTRUCTIONS D'INSTALLATION ET D'ENTRETIEN fourni avec votre machine.

Pour les dimensions détaillées du produit, consultez le GUIDE DE DIMENSION disponible sur www.whirlpool.com/owners ou www.whirlpool.ca/owners si vous résidez au Canada.

Pour plus d'informations sur l'une des rubriques ci-après, veuillez visiter www.whirlpool.com/owners ou www.whirlpool.ca/owners si vous résidez au Canada. Cette vérification peut vous faire économiser le coût d'une intervention de dépannage.

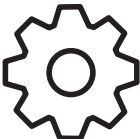
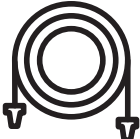
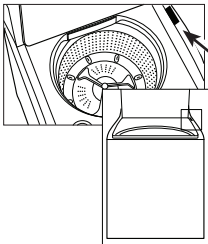
ENREGISTRER PRODUIT	PRENDRE RENDEZ-VOUS	COMMENT FAIRE ET FAQ	MANUELS ET TÉLÉCHARGEMENTS	AJOUTER UN PLAN DE SERVICE	PIÈCES	ACCESSOIRES		
								
 <p data-bbox="321 688 448 800">Emplacement du numéro de modèle et du numéro de série</p>		<p data-bbox="509 594 1484 646">Pour communiquer avec un représentant du service à la clientèle ou si vous avez des questions, appelez-nous sans frais au 1-866-698-2538 ou au 1-800-688-2002 si vous résidez au Canada.</p> <p data-bbox="662 657 1328 684">Vous pouvez adresser tous commentaires ou toutes questions à :</p> <table data-bbox="565 695 1401 804"> <tr> <td data-bbox="565 695 878 804"> Whirlpool Brand Appliances Customer eXperience Center 533 Benson Road Benton Harbor, MI 49022-2692 </td> <td data-bbox="1089 695 1401 804"> Whirlpool Brand Appliances Customer eXperience Center Unit 200-6750 Century Ave Mississauga, Ontario L5N 0B7 </td> </tr> </table> <p data-bbox="516 814 1474 867">Veuillez indiquer dans votre correspondance un numéro de téléphone où l'on peut vous joindre dans la journée.</p>					Whirlpool Brand Appliances Customer eXperience Center 533 Benson Road Benton Harbor, MI 49022-2692	Whirlpool Brand Appliances Customer eXperience Center Unit 200-6750 Century Ave Mississauga, Ontario L5N 0B7
Whirlpool Brand Appliances Customer eXperience Center 533 Benson Road Benton Harbor, MI 49022-2692	Whirlpool Brand Appliances Customer eXperience Center Unit 200-6750 Century Ave Mississauga, Ontario L5N 0B7							

GUÍA DE REFERENCIA RÁPIDA

LAVADORA DE CARGA SUPERIOR WHIRLPOOL®

PANEL DE CONTROL Y CARACTERÍSTICAS

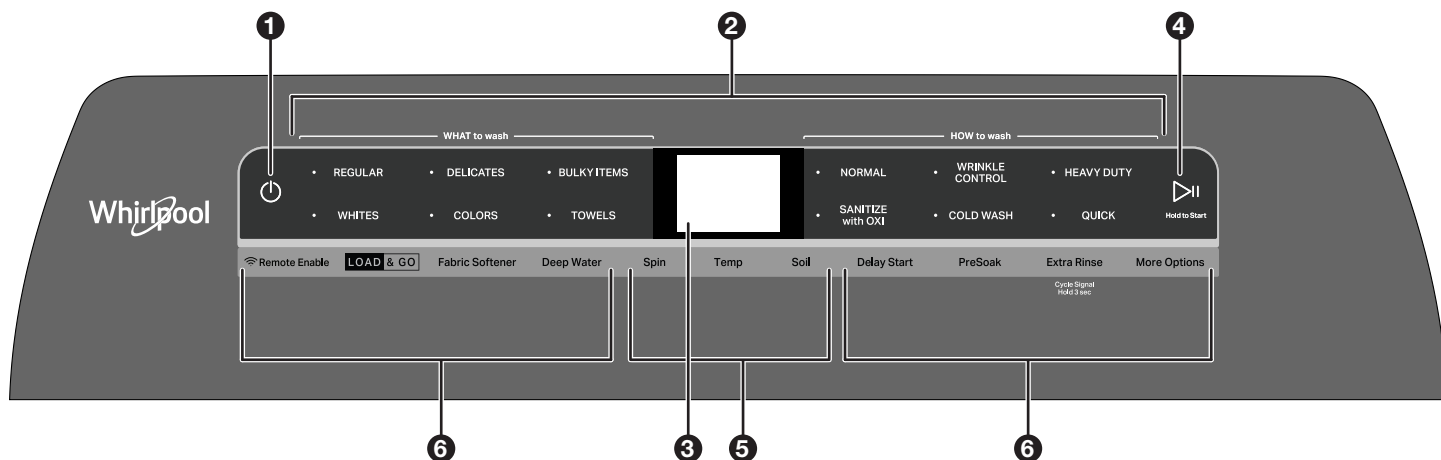

La apariencia puede variar según el modelo.

1 POWER (ENCENDIDO)

Toque esta opción para encender/apagar o para detener/cancelar un ciclo.

2 QUÉ LAVAR/CÓMO LAVAR

Primero seleccione un ciclo en "What to Wash" (Qué lavar) y luego seleccione "How to Wash" (Cómo lavar) para obtener el mejor ciclo de combinación disponible para el tipo de artículos que va a lavar. Consulte la "Guía de ciclos" para obtener detalles sobre los ciclos.

3 PANTALLA LED DE TIEMPO/ESTADO

La pantalla muestra el tiempo que falta para que el ciclo se complete. Factores tales como el tamaño de la carga y la presión del agua pueden afectar el tiempo que se muestra en la pantalla. Las cargas apretujadas, las cargas desequilibradas o el exceso de espuma también pueden hacer que la lavadora regule el tiempo del ciclo. Si ha configurado un inicio con retraso para el ciclo, la pantalla mostrará el tiempo de retraso regulado.

ADD GARMENT (Agregar prenda)

Cuando Add Garment (Agregar prenda) está iluminado, puede hacer una pausa en el ciclo, abrir la tapa y agregar artículos. Mantenga presionado el botón START/PAUSE (Inicio/Pausa) para comenzar el ciclo nuevamente.

4 START/PAUSE (Inicio/Pausa)

Mantenga presionado START/PAUSE (Inicio/Pausa) para comenzar el ciclo. Toque esta opción durante un ciclo para pausarlo y desbloquear la tapa.

NOTA: Si la máquina está centrifugando, la tapa puede tardar más para desbloquearse.

5 MODIFICADORES DE CICLO (No todos los modificadores están disponibles con todos los ciclos).

SPIN (Centrifugado)

Toque esta opción para modificar las velocidades de centrifugado disponibles en el ciclo (Off [Apagado], Medium [Medio], Fast [Rápido]).

TEMP (Temperatura)

Toque esta opción para modificar las temperaturas de agua disponibles en el ciclo (Tap Cold [Fria del grifo], Cold [Muy fria], Cool [Fría], Warm [Tibia], Hot [Caliente]).

SOIL (Suciedad)

Toque esta opción para modificar los niveles de suciedad disponibles en el ciclo. Aumente el nivel de suciedad para artículos muy sucios y disminúyalo para artículos menos sucios (Extra Light [Muy ligero], Light [Ligero], Normal [Normal], Heavy [Intenso], Extra Heavy [Superintenso]).

6 OPCIONES DE CICLO (No todas las opciones están disponibles en todos los ciclos)

REMOTE ENABLE (Activación remota)

Toque cada vez que desee controlar de manera remota a través de la aplicación de Whirlpool®. Siga las instrucciones que aparecen en la sección "obtener la aplicación de Whirlpool® y conectarse" a continuación para obtener más detalles. Abrir la tapa cancela la función "Remote Enable" (Activación remota).

Dosificador automático LOAD & GO™

El dosificador Load & Go™ tiene 1 litro de detergente y determina la mejor cantidad de detergente y el mejor momento para agregarlo a la carga. Consulte la sección "Uso de los dosificadores" para obtener más información.

FABRIC SOFTENER (Suavizante de telas)

Toque el botón "Fabric softener" (Suavizante de telas) para que la máquina sepa cuando ha agregado suavizante de telas en el dosificador apropiado.

DEEP WATER (Agua profunda)

Toque el botón "Deep Water" (Agua profunda) para agregar más agua a la lavadora del nivel autodetectado del ciclo (Auto [Automático], Medium [Medio], High [Alto], Max Fill [Llenado máximo]).

NOTA: Es probable que los tiempos de los ciclos sean más largos debido al mayor tiempo de llenado cuando se usa la opción Deep Water (Agua profunda).

DELAY START (Inicio diferido)

Toque esta opción para demorar el inicio del ciclo de lavado hasta por un máximo de 12 horas.

PRESOAK (Remojo previo)

Presione para agregar un periodo de remojo previo a cualquier ciclo de lavado y ayudar a aflojar las manchas rebeldes. La lavadora se llenará, hará una pausa para el remojo y luego comenzará el ciclo seleccionado (15 min, 30 min, 60 min o 120 min).

EXTRA RINSE (Enjuague adicional)

Toque esta opción para agregar automáticamente un segundo enjuague a la mayoría de los ciclos.

CYCLE SIGNAL (Señal de ciclo)

Toque esta opción para encender o apagar el final de la señal de ciclo y ajustar el volumen del sonido cuando se presiona un botón.

MORE OPTIONS (Más opciones)

- Drain & Spin (Desagote y centrifugado)
- Rinse & Spin (Enjuague y centrifugado)
- Clean Washer with affresh® (Limpiar la lavadora con affresh®)
- Ciclo favorito

OBTENER LA APLICACIÓN WHIRLPOOL® Y CONECTARSE



Descargue la aplicación Whirlpool® en su dispositivo móvil. Puede acceder a las instrucciones de registro y conectividad, los términos de uso y la política de privacidad en www.whirlpool.com/connect o, en Canadá, en www.whirlpool.ca/connect.

Una vez instalada, inicie la aplicación y será guiado por los pasos para registrarse y crear su cuenta de usuario para conectar su electrodoméstico. Si tiene consultas o problemas, llame a Whirlpool® Connected Appliances al **1-866-333-4591**.

1 CONECTAR LA UNIDAD A INTERNET

Para conectar la unidad a Internet, descargue la aplicación de Whirlpool® y presione REMOTE ENABLE (Activación remota).

2 HABILITAR INTERACCIÓN Y CONTROL REMOTO

El usuario debe presionar REMOTE ENABLE (Activación remota) cuando esté conectado para poder habilitar la interacción y el control remoto.

USO DE SU LAVADORA

⚠ ADVERTENCIA

Peligro de Incendio

Nunca coloque en la lavadora artículos que estén humedecidos con gasolina o cualquier otro líquido inflamable.

Ninguna lavadora puede eliminar completamente el aceite.

No seque ningún artículo que haya tenido alguna vez cualquier tipo de aceite (incluyendo aceites de cocina).

No seguir estas instrucciones puede ocasionar la muerte, explosión o incendio.

1 SEPARE Y PREPARE LA ROPA

Consulte la sección Recomendación para cargar a continuación.

2 AGREGUE EL DETERGENTE DE ALTO RENDIMIENTO (HE) Y LOS PRODUCTOS PARA LAVAR EN LOS DEPÓSITOS*

Cajón de dosificador Dosificador automático

Retire la bandeja interna para el detergente en polvo de alto rendimiento (HE).

3 TOQUE POWER (ENCENDIDO) PARA ENCENDER LA LAVADORA

4 SELECCIONE EL CICLO DESEADO PARA SU CARGA*

5 AJUSTE LA CONFIGURACIÓN DEL CICLO, SI LO DESEA*

6 SELECCIONE LAS OPCIONES ADICIONALES*

7 MANTENGA PRESIONADO START/PAUSE (INICIO/PAUSA) PARA COMENZAR EL CICLO

* **NOTA:** No todos los ciclos, ajustes u opciones están disponibles con todos los modelos.

RECOMENDACIÓN PARA CARGAR



Se recomienda colocar los artículos en montones flojos y de modo parejo alrededor de la pared de la placa de lavado y el agitador para lograr un funcionamiento óptimo. No coloque los artículos en sentido longitudinal alrededor de la placa de lavado o del agitador.

TRATAR PREVIAMENTE ANTES DE HACER FUNCIONAR UN CICLO DE LAVADO

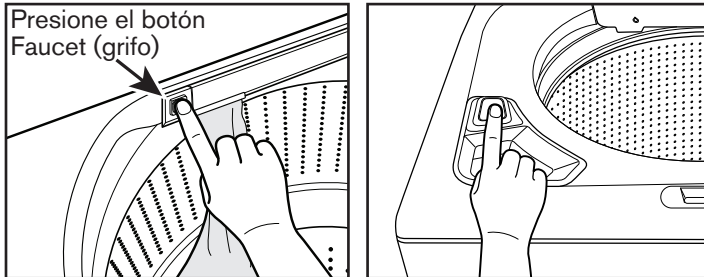

Operación del grifo de agua

- Presione el botón Faucet (Grifo) una vez para encenderlo y nuevamente para apagarlo.
- El grifo se apagará automáticamente después de 10 minutos o cuando se alcance el nivel de agua máximo.
- El agua se desagotará automáticamente si el nivel es demasiado alto o si se deja la tapa abierta 10 minutos.
- En los modelos con la función Load & Go™, cuando el grifo está encendido, toque el botón TEMP (Temperatura) para seleccionar la temperatura del agua, o bien toque el botón LOAD & GO para dosificar manualmente el detergente.

USO DEL CEPILLO DE TELAS PARA TRATAR PREVIAMENTE

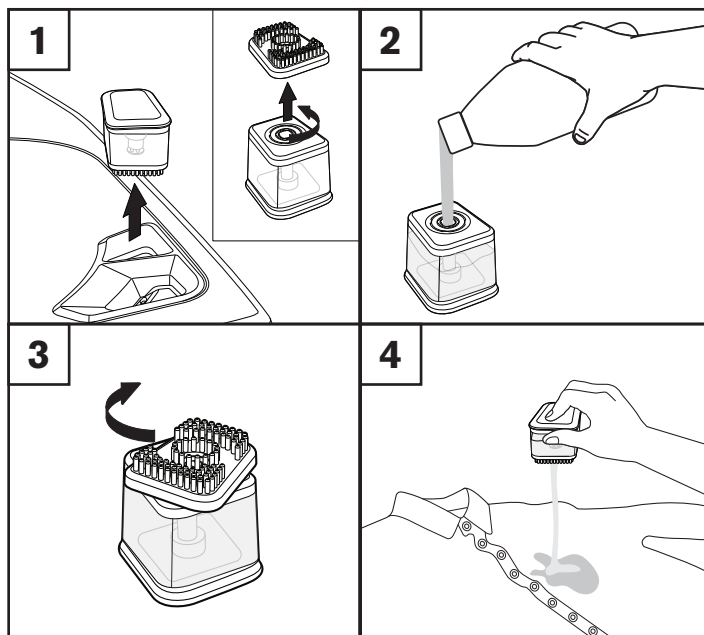

1. Gire el cepillo del cuerpo para abrirlo.
2. Agregue detergente líquido de limpieza.
3. Gire para cerrar.
4. Para dosificar el detergente desde el cepillo de tela, presione el botón.

ADVERTENCIA: No lave prendas resistentes o tipo resistentes al agua. No seguir de cerca estas instrucciones puede resultar en una condición de vibración anormal y desequilibrio que podría ocasionar lesiones físicas, daños a la propiedad y/o daños al aparato.

MÁS AGUA CUANDO LA NECESITA

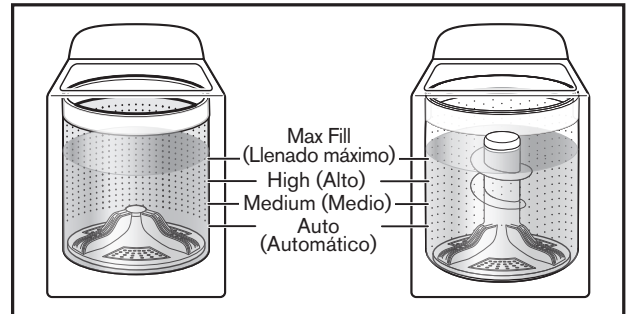

Detección automática y lavado Deep Water (Agua profunda)

- La lavadora está diseñada y optimizada para proporcionar una limpieza profunda con menos agua a fin de conservar la energía y los recursos. La lavadora ajusta automáticamente el nivel del agua en la cantidad óptima para lavar con gran eficiencia el tamaño de carga detectado.
- Toque "DEEP WATER" (Agua profunda) para agregar más agua a la carga de lavado.
- Hay cuatro niveles de agua profunda: "Auto" (Automático), "Medium" (Medio), "High" (Alto) y "Max Fill" (Llenado máximo).
- No todos los niveles están disponibles con todos los ciclos.
- A medida que la lavadora moje y mueva la carga, el nivel de los artículos se asentará en la canasta. Esto es normal y no indica que deban agregarse más prendas.

IMPORTANTE: No observará una canasta llena de agua, como en las lavadoras antiguas y menos eficientes. Es normal que parte de la carga quede por encima del nivel de agua.

USO DEL DOSIFICADOR*

- A menos que se desactive, la función Load & Go™ estará encendida por defecto en cada ciclo.
- Toque el botón LOAD & GO para ver las opciones de dosificación de detergente.
- Mantenga presionado el botón LOAD & GO en el panel de control para seleccionar una concentración de detergente entre 2X y 10X. Mantenga presionado durante 3 segundos.
- Tire del cajón completamente hacia afuera para que sea más fácil llenarlo.

*En modelos equipados con cajón del dosificador Load and Go.

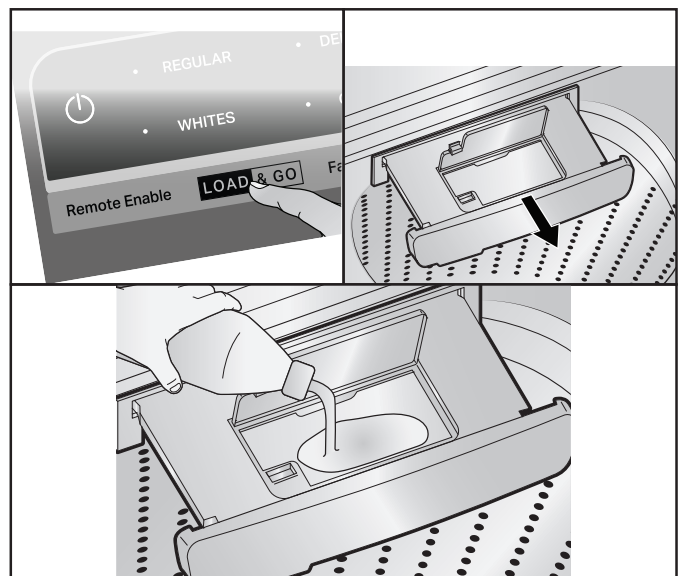

GUÍA DE CICLOS

La lavadora Whirlpool® tiene una interfaz de usuario exclusiva para ayudarle a seleccionar el mejor ciclo requerido para la carga. El diagrama "What to Wash" (Qué lavar), "How to Wash" (Cómo lavar) lo guía para el ciclo óptimo en dos pasos simples:

Primero determine qué artículos hay en la carga que intenta lavar. Use eso como guía para su selección de "What to Wash" (Qué lavar). Luego determine cómo quiere que la lavadora los lave y elija la selección "How to Wash" (Cómo lavar) adecuada. Consulte la tabla a continuación para más detalles.

Para un cuidado óptimo de las telas, elija el ciclo que sea más adecuado para la carga que va a lavar.

R – Ciclo recomendado

a – Ciclo alternativo

En blanco – El ciclo está disponible pero no es óptimo

		¿Cómo desea lavar?					
		Selección de ciclos "How to Wash" (Cómo lavar)					
		Normal (Normal)	Wrinkle Control (Control de arrugas)	Heavy Duty (Intenso)	Sanitize with Oxi (Higienización con Oxi)	Cold Wash (Lavado con agua fría)	Quick (Rápido)
		Energy Conscious (Control de energía)	Reduce Wrinkles (Reducción de arrugas)	Powerful Soil Removal (Eliminación intensa de suciedad)	Eliminate Bacteria* (Eliminación de bacterias)	Energy Save (Ahorro de energía)	Fast (Rápido)
¿Qué desea lavar?	Selección de ciclo "What to Wash" (Qué lavar)						
Algodón/lino	Regular (Común)	R	a	a	a	a	a
Mezclado		R	a	a	a	a	a
Pijamas		R	a	a	a	a	a
Buzos		R	a	a	a	a	a
Camisetas		R	a	a	a	a	a
Ropa deportiva	Colors (Prendas de color)	R	a	a	a	a	a
Colores vivos		R	a	a	a	a	a
Ropa de trabajo informal		a	R	a	a	a	a
Ropa informal		a	R	a	a	a	a
Colores oscuros		R	a	a	a	a	a
Camisas/pantalones de vestir		a	R	a	a	a	a
Jeans		R	a	a	a	a	a
Telas que no se planchan	a	R	a	a	a	a	
Ropa de bebé	Whites (Prendas blancas)	R	a	a	a		
Pañuelos de mano		R	a	a	a		a
Servilletas		R	a	a	a		a
Calcetines		R	a	a	a		a
Manteles		R	a	a	a	a	a
Ropa interior		R	a	a	a	a	a
Prendas blancas		R	a	a	a		a
Camisas blancas		R	a	a	a		a
Toallas blancas		R	a	a	a		a
Camisetas blancas		R	a	a	a		a
Sostenes		R	a	a	a	a	a
Prendas delicadas	R	a	a	a	a	a	
Telas de lavado a mano	R	a	a	a	a	a	
Lencería	R	a	a	a	a	a	
Sedas para lavar a máquina	R	a	a	a	a	a	
Lana	R	a	a	a	a	a	
Frazadas	Bulky Items (Artículos voluminosos)	R	a	a	a	a	a
Abrigos y chaquetas		R	a	a	a	a	a
Mantas		R	a	a	a		a
Cortinas para lavar a máquina		R	a	a	a	a	a
Fundas para lavar a máquina		R	a	a	a		a
Alfombras sin revestimiento de caucho		R	a	a	a		a
Sábanas		R	a	a	a		a
Bolsas de dormir		R	a	a	a		a
Repasadores	Towels (toallas)	R	a	a	a		a
Telas de toalla		R	a	a	a		a
Toallas		R	a	a	a		a

* Use este ciclo para eliminar el 99,9 % de las bacterias cuando lo use en conjunto con la opción Oxi. Se deben utilizar los ajustes prefijados para lograr la higienización adecuada. Asegúrese de agregar un producto Oxi a la canasta antes del comienzo del ciclo.

ÍCONOS DE LA LAVADORA



































Image	Description	Estado
	Door locked (Puerta cerrada)	Alert State
	Load & Go Warning (avertissement Load & Go)	Off One Cycle
		Off Always
		Detergent Low
	Remote Enable (Activación remota)	On (activé)
	Delay Start (Inicio diferido)	On (activé)
	Presoak (Remojo previo)	On (activé)
	Deep Water (Agua profunda)	On - Auto (activé - automatique)
		On - Auto Medium (activé - automatique moyen)
		On - Auto High (activé - automatique élevé)
		On - Max Fill (activé - remplissage maximal)
	Fabric Softener (Suavizante de telas)	On (activé)
	Extra Rinse (Enjuague adicional)	On (activé)
	Load & Go (Nota sobre)	50%
		75%
		Full

Image	Description	Estado
	Smartgrid, Peak rates in effect (SmartGrid, tasas máximas activadas)	On (activé)
		Smart Delay (mise en marche différée intelligente)
		Smart Pause (mise en pause intelligente)
	WiFi Status Indicator (Indicador de estado del WiFi)	Connected (connecté)
		Disconnected (déconnecté)
	Fabric Softener (Suavizante de telas)	Off (désactivé)
	Extra Rinse (Enjuague adicional)	Off (désactivé)
	Presoak (Remojo previo)	Off (désactivé)
	Favorite Cycle (Ciclo favorito)	
	Download & Go Cycle (Programme Download & Go)	
	Cycle Signal (Señal de ciclo)	Off (désactivé)
		Low (bas)
		Medium (moyen)
		High (élevé)
	Clean Washer (Limpiar lavadora)	
	Remote Enable (Activación remota)	Off (désactivé)
	Faucet (Grifo)	On (activé)
		Off (désactivé)







NOTA: No todas las características y opciones están disponibles en todos los modelos.

ASISTENCIA O SERVICIO TÉCNICO, E INFORMACIÓN ADICIONAL

Para obtener instrucciones de instalación e información sobre mantenimiento, almacenamiento durante el invierno y transporte, consulte el MANUAL DE INSTRUCCIONES DE INSTALACIÓN Y CUIDADO que viene incluido con su máquina.

Para ver las dimensiones detalladas del producto, consulte la GUÍA DE DIMENSIONES que se puede consultar en www.whirlpool.com/owners o, en Canadá, en www.whirlpool.ca/owners.

Para obtener información sobre cualquiera de los siguientes artículos, visite www.whirlpool.com/owners o, en Canadá, www.whirlpool.ca/owners. Esto le podría ahorrar el costo de una llamada al servicio técnico.

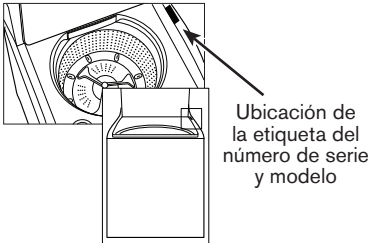
REGISTRAR PRODUCTO	PROGRAMAR SERVICIO TÉCNICO	INSTRUCCIONES Y PREGUNTAS FRECUENTES	MANUALES Y DESCARGAS	AGREGAR PLAN DE SERVICIO	PIEZAS	ACCESORIOS		
								
 <p>Ubicación de la etiqueta del número de serie y modelo</p>		<p>Para hablar con un representante de atención al cliente o si tiene más preguntas, llámenos sin cargo al 1-866-698-2538 o, en Canadá, al 1-800-688-2002.</p> <p>Usted puede escribir con cualquier pregunta o preocupación a:</p> <table style="width: 100%; border: none;"> <tr> <td style="width: 50%; vertical-align: top;"> Whirlpool Brand Appliances Customer eXperience Center 533 Benson Road Benton Harbor, MI 49022-2692 </td> <td style="width: 50%; vertical-align: top;"> Whirlpool Brand Appliances Customer eXperience Center Unit 200-6750 Century Ave Mississauga, Ontario L5N 0B7 </td> </tr> </table> <p>Incluya en su correspondencia un número de teléfono en el que se le pueda localizar durante el día.</p>					Whirlpool Brand Appliances Customer eXperience Center 533 Benson Road Benton Harbor, MI 49022-2692	Whirlpool Brand Appliances Customer eXperience Center Unit 200-6750 Century Ave Mississauga, Ontario L5N 0B7
Whirlpool Brand Appliances Customer eXperience Center 533 Benson Road Benton Harbor, MI 49022-2692	Whirlpool Brand Appliances Customer eXperience Center Unit 200-6750 Century Ave Mississauga, Ontario L5N 0B7							

NOTAS

NOTAS

NOTAS

NOTAS

NOTAS

