

10

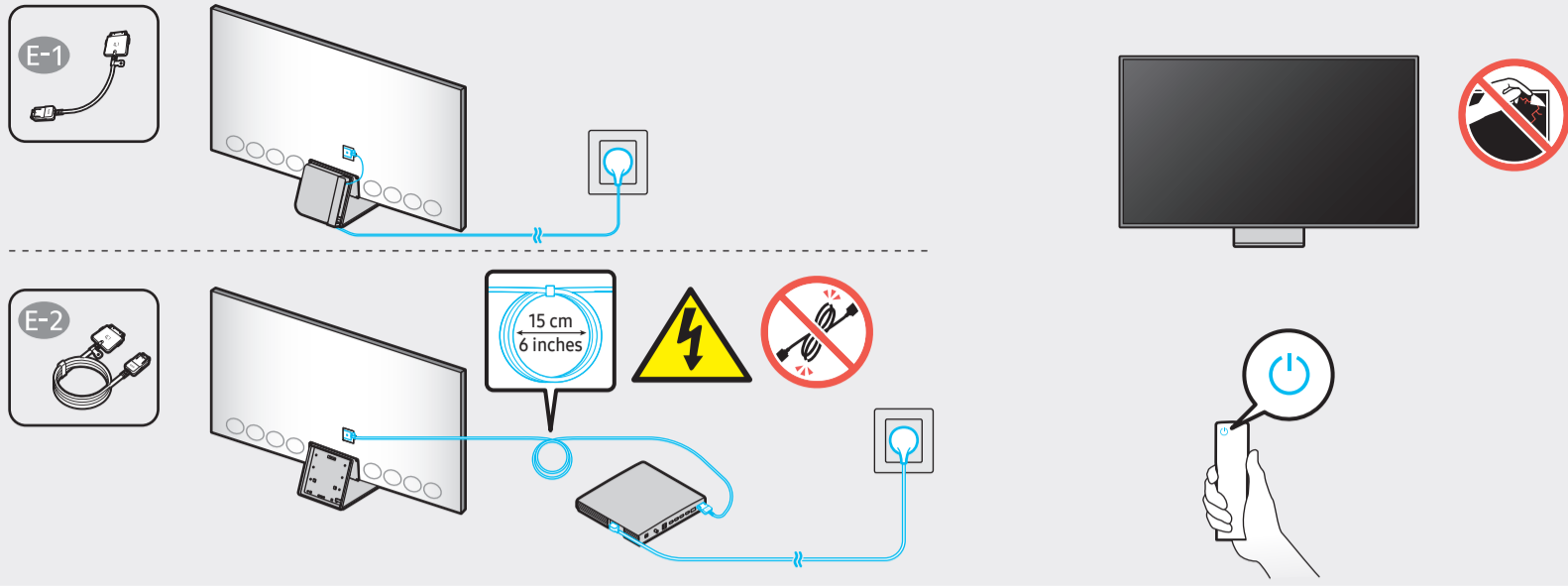

* When installing the TV as wallmount, You can place the One Connect Box as shown below. / Lorsque vous installez le téléviseur sur un support mural, vous pouvez positionner le boîtier One Connect comme indiqué ci-dessous.
 * To install using a wall mount, be sure to use the supplied HOLDER-WALL RING. / Pour procéder à l'installation à l'aide d'un support mural, utilisez les ANNEAUX DE SUPPORT MURAL fournis.

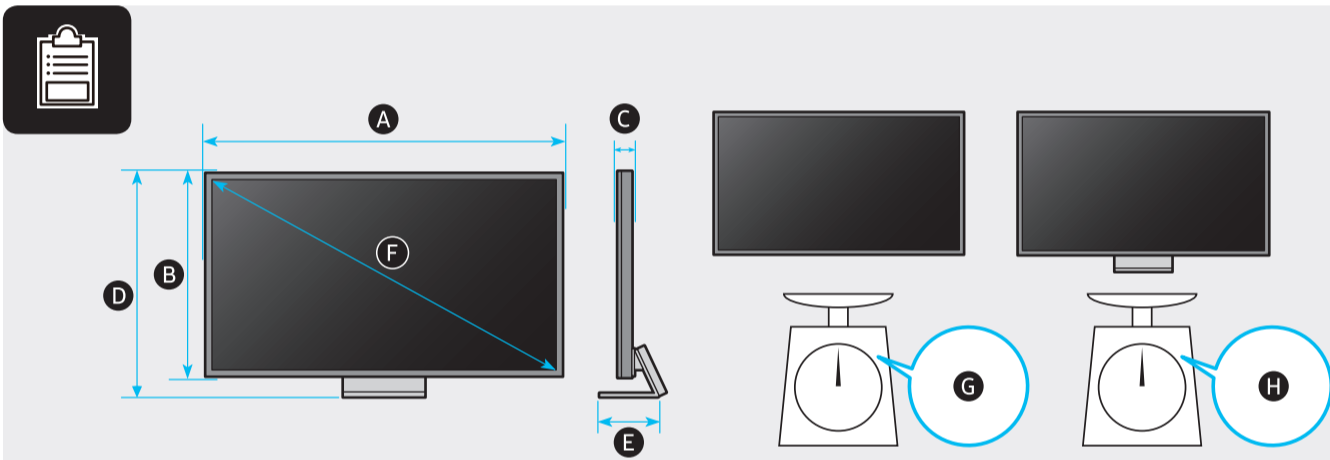
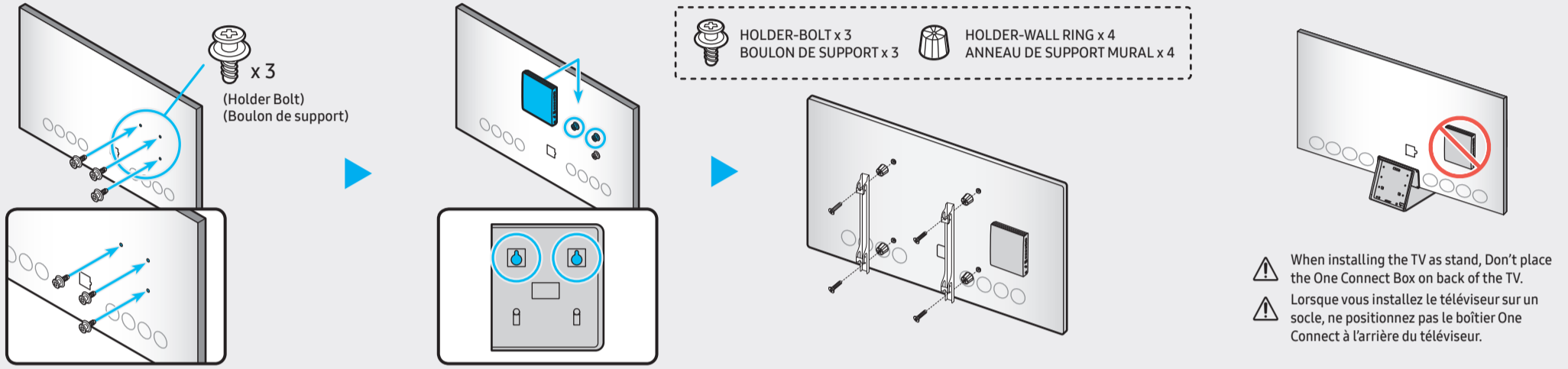

* : 0~9, A~Z

	A	B	C	D	E	F	G	H
QN75QN8**A	65.7 inches (1668.3 mm)	37.6 inches (955.6 mm)	0.7 inches (17.2 mm)	40.3 inches (1022.9 mm)	12.6 inches (320.5 mm)	74.5 inches	70.8 lbs (32.1 kg)	93.0 lbs (42.2 kg)
QN85QN8**A	74.5 inches (1893.4 mm)	42.6 inches (1083.0 mm)	0.7 inches (17.4 mm)	45.1 inches (1145.8 mm)	13.5 inches (343.7 mm)	84.5 inches	95.5 lbs (43.3 kg)	119.7 lbs (54.3 kg)
QN75QN9**A	65.1 inches (1654.8 mm)	37.2 inches (945.6 mm)	0.6 inches (15.4 mm)	40.0 inches (1016.6 mm)	12.6 inches (320.5 mm)	74.5 inches	68.3 lbs (31.0 kg)	90.4 lbs (41.0 kg)
QN85QN9**A	73.9 inches (1876.6 mm)	42.2 inches (1071.5 mm)	0.6 inches (15.4 mm)	45.1 inches (1144.8 mm)	13.5 inches (343.7 mm)	84.5 inches	95.0 lbs (43.1 kg)	119.3 lbs (54.1 kg)

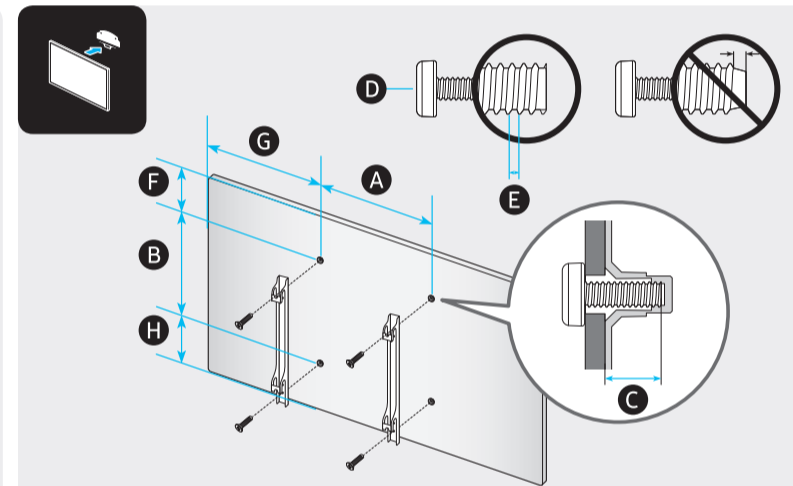

* : 0~9, A~Z

	QN75QN8**A	QN85QN8**A	QN75QN9**A	QN85QN9**A
VESA A x B (mm)	400 x 400	600 x 400	400 x 400	600 x 400
C (mm)	5-6			
D x 4	M8			
E (mm)	1.25			
F (inches)	8.5	8.5	8.3	8.3
G (inches)	25.0	25.5	24.7	25.1
H (inches)	13.1	18.2	13.0	18.0

SAMSUNG

QUICK SETUP GUIDE GUIDE D'INSTALLATION RAPIDE

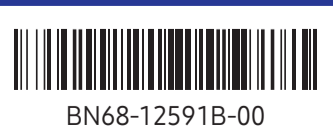

BN68-12591B-00



75"

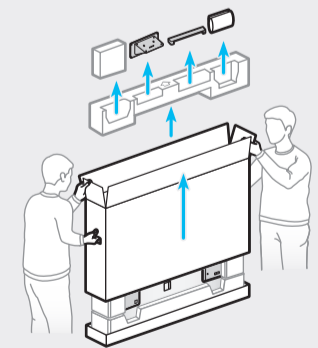

85"

