

EMBD3010AS

User Manual
Microwave Oven

EN 2

Manuel de l'Utilisateur
Four micro-onde

FR 29



Welcome to Electrolux! Thank you for choosing our appliance.

For Customer Care support and webshop visit:
www.electroluxappliances.com

For extended version of User Manual visit:
www.electroluxappliances.com

IMPORTANT SAFETY INSTRUCTIONS	2	CONVECTION COOKING.....	19
PART NAMES	8	CONVENIENT FEATURES.....	23
CONTROL PANEL.....	9	CLEANING AND CARE	26
BEFORE OPERATING.....	10	SERVICE CALL CHECK.....	27
MANUAL COOKING.....	11	SPECIFICATIONS.....	27
AUTO COOKING.....	14	MAJOR APPLIANCE WARRANTY INFORMATION.....	28
SENSOR COOKING.....	17		

This manual is your resource for the use and care of your product. Please read it before using your appliance. Keep it handy for quick reference. If something doesn't seem right, the troubleshooting section will help you with common issues.

FAQs, helpful tips and videos, cleaning products, and kitchen and home accessories are available at www.frigidaire.com.

We are here for you! Visit our website, chat with an agent, or call us if you need help. We may be able to help you avoid a service visit. If you do need service, we can get that started for you.

Let's make it official! Be sure to register your product.

Keep your product info. here so it's easy to find.

Model Number:

Serial Number:

Purchase Date:

For your safety the information in this manual must be followed to minimize the risk of fire or explosion or to prevent property damage, personal injury or loss of life.



WARNING

TO AVOID POSSIBLE EXPOSURE TO EXCESSIVE MICROWAVE ENERGY

- Do not attempt to operate this oven with the door open since open-door operation can result in harmful exposure to microwave energy. It is important not to defeat or tamper with the safety interlocks.
- Do not place any object between the oven front face and the door or allow soil or cleaner residue to accumulate on sealing surfaces.
- Do not operate the oven if it is damaged. It is particularly important that the oven door close properly and that there is no damage to the: (1) door (bent), (2) hinges and latches (broken or loosened), (3) door seals and sealing surfaces.
- The oven should not be adjusted or repaired by anyone except properly qualified service personnel.

IMPORTANT SAFETY INSTRUCTIONS

Definitions

 This is the safety alert symbol. It is used to alert you to potential personal injury hazards. Obey all safety messages that follow this symbol to avoid possible injury or death.

WARNING

WARNING indicates a potentially hazardous situation which, if not avoided, could result in death or serious injury.

CAUTION

CAUTION indicates a potentially hazardous situation which, if not avoided, may result in minor or moderate injury.

READ ALL INFORMATION BEFORE USING

WARNING

To reduce the risk of fire, burns, electric shock, injury to persons, or exposure to excessive microwave energy when using your appliance, follow basic **caution, including the following sections.**

- Read all instructions before using the appliance.
- Read and follow the specific **"CAUTION TO AVOID POSSIBLE EXPOSURE TO EXCESSIVE MICROWAVE ENERGY"** on page 2.
- This appliance must be grounded. Connect only to properly grounded outlet. See **"GROUNDING INSTRUCTIONS"** on page 5.
- Install or locate this appliance only in accordance with the provided installation instructions.
- Some products such as whole eggs and sealed containers—for example, closed glass jars—are able to explode and should not be heated in this microwave oven.
- Use this appliance only for its intended use as described in this manual. Do not use corrosive chemicals or vapors in this appliance. This type of microwave oven is specifically designed to heat, cook or dry food. It is not designed for industrial or laboratory use.
- As with any appliance, close supervision is necessary when used by children.
- Do not operate this appliance if it has a damaged cord or plug, if it is not working properly or if it has been damaged or dropped.
- This appliance should be serviced only by qualified service personnel. Contact nearest Electrolux Authorized Servicer for examination, repair or adjustment.
- Do not cover or block any openings on the appliance.
- Do not store or use this appliance outdoors. Do not use this product near water—for example, near a kitchen sink, in a wet basement or near a swimming pool, or similar locations.
- Do not immerse cord or plug in water.
- Keep cord away from heated surfaces.
- Do not let cord hang over edge of table or counter.
- See door surface cleaning instructions on page 26.

- To reduce the risk of fire in the microwave oven cavity:
 - **Do not overcook food. Carefully attend appliance when paper, plastic or other combustible materials are placed inside the microwave oven to facilitate cooking.**
 - Remove wire twist-ties from paper or plastic bags before placing bag in microwave oven.
 - **If materials inside the microwave oven ignite, keep microwave oven door closed, turn microwave oven off and disconnect the power cord or shut off power at the fuse or circuit breaker panel.**
 - Do not use the cavity for storage purposes. Do not leave paper products, cooking utensils or food in the cavity when not in use.
- Liquids, such as water, coffee or tea are able to be overheated beyond the boiling point without appearing to be boiling. Visible bubbling or boiling when the container is removed from the microwave oven is not always present. **THIS COULD RESULT IN VERY HOT LIQUIDS SUDDENLY BOILING OVER WHEN A SPOON OR OTHER UTENSIL IS INSERTED INTO THE LIQUID.**

To reduce the risk of injury to persons:

- Do not overheat the liquid.
- Stir the liquid both before and halfway through heating it.
- Do not use straight-sided containers with narrow necks. Use a wide-mouthed container.
- After heating, allow the container to stand in the microwave oven at least for 20 seconds before removing the container.
- Use extreme care when inserting a spoon or other utensil into the container.
- Clean ventilation openings frequently. Grease should not be allowed to accumulate on ventilation openings.
- Use care when cleaning the ventilation openings. Corrosive cleaning agents, such as lye-based oven cleaners, may damage the ventilation openings.

SAVE THESE INSTRUCTIONS

IMPORTANT SAFETY INSTRUCTIONS

- When using the convection or combination cooking functions, both the outside and inside of the oven will become hot. Always use hot pads to remove containers of food and cooking accessories such as the oven shelf, metal turntable and ceramic tray.
- Do not clean with metal scouring pads. Pieces off the pad can touch electrical parts involving risk of electric shock.
- *Thermometer*— Do not use regular cooking or oven thermometers when cooking by microwave or combination. The metal and mercury in these thermometers could cause arcing and possible damage to the oven. Do not use a thermometer in food you are microwaving unless the thermometer is designed or recommended for use in the microwave oven.
- Oversized foods or oversized metal utensils should not be inserted in a microwave/toaster oven as they may create a fire or risk of electric shock.
- Do not use paper products when appliance is operated in the toaster mode.
- Do not store any materials, other than manufacturer's recommended accessories, in this oven when not in use.



WARNING

If you see arcing, press the **Cancel** button and correct the problem.

ARCING

Arcing is the microwave term for sparks in the oven. Arcing is caused by:

- The metal shelf not installed correctly so it touches the microwave wall.
- Metal or foil touching the side of the oven.
- Foil not molded to food (upturned edges act like antennas).
- Metal, such as twist-ties, poultry pins, or gold-rimmed dishes, in the microwave.
- Recycled paper towels containing small metal pieces being used in the microwave.



WARNING

Do not cover racks or any other part of the oven with metal foil. This will cause overheating of the oven.

Federal Communications Commission Radio Frequency Interference Statement (U.S.A. Only)

This equipment generates and uses ISM frequency energy and if not installed and used properly, that is in strict accordance with the manufacturer's instructions, may cause interference to radio and television reception. It has been type tested and found to comply with limits for ISM Equipment pursuant to part 18 of FCC Rules, which are designed to provide reasonable protection against such interference in a residential installation.

However, there is no guarantee that interference will not occur in a particular installation. If this equipment does cause interference to radio or television reception, which can be determined by turning the equipment off and on, the user is encouraged to try to correct the interference by one or more of the following:

- Reorient the receiving antenna of the radio or television.
- Relocate the microwave oven with respect to the receiver.
- Move the microwave oven away from the receiver.
- Plug the microwave oven into a different outlet so that the microwave oven and the receiver are on different branch circuits.

The manufacturer is not responsible for any radio or television interference caused by unauthorized modification to this microwave oven. It is the responsibility of the user to correct such interference.

Short Cord Instruction: a) A short power-supply cord is provided to reduce the risks resulting from becoming entangled in or tripping over a longer cord. b) Longer cord sets or extension cords are available and may be used if care is extension in their use. c) If a long cord or extension cord is used:

- 1) The marked electrical rating of the cord set or extension cord should be at least as great as the electrical rating of the appliance;
- 2) The extension cord must be a grounding-type 3-wire cord; and
- 3) The longer cord should be arranged so that it will not drape over the counter top or tabletop where it can be pulled on by children or tripped over unintentionally.

IMPORTANT SAFETY INSTRUCTIONS

UNPACKING AND EXAMINING YOUR MICROWAVE OVEN

Appliance is to be installed and grounded by a qualified technician.

Open the bottom of the carton, bend the carton flaps back and tilt the microwave oven over to rest on plastic foam pad. Lift carton off microwave oven and remove all packing materials, Installation Instructions, wire rack, ceramic microwave tray, metal tray turnable.

SAVE THE CARTON AS IT MAY MAKE INSTALLATION EASIER.

- Remove the feature sticker from the outside of the door, if there is one.
- DO NOT REMOVE THE WAVEGUIDE COVER, which is located on the ceiling in the microwave oven cavity. Read enclosures and SAVE the Use and Care Manual.

Check the microwave oven for any damage, such as misaligned or bent door, damaged door seals and sealing surfaces, broken or loose door hinges and latches and dents inside the cavity or on the door. If there is any damage, do not operate the microwave oven and contact your dealer or ELECTROLUX SERVICER. See Installation Instructions for more details.

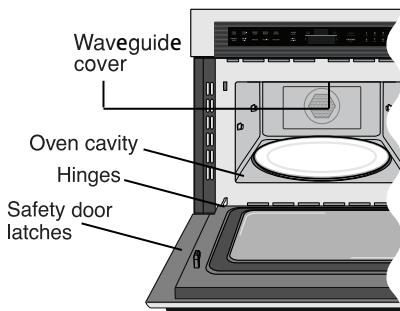

GROUNDING INSTRUCTIONS

This appliance must be grounded. This microwave oven is equipped with a cord having a grounding wire with a grounding plug. It must be plugged into a wall receptacle that is properly installed and grounded in accordance with the National Electrical Code and local codes and ordinances. In the event of an electrical short circuit, grounding reduces risk of electric shock by providing an escape wire for the electric current.

WARNING

Improper use of the grounding plug can result in a risk of electric shock.

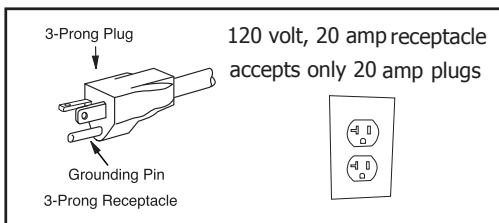

Electrical Requirements

Check Installation Instructions for proper location for the power supply.

The electrical requirements are a 120 volt 60 Hz, AC only, 20 amp. or more protected electrical supply. It is recommended that a separate circuit serving only the microwave oven be provided.

The microwave oven is equipped with a 3-prong grounding plug. It must be plugged into a wall receptacle that is properly installed and grounded. DO NOT UNDER ANY CIRCUMSTANCES CUT OR REMOVE THE GROUNDING PIN FROM THE PLUG.

If it is necessary to use an extension cord, use only a 3-wire extension cord that has a 3-blade grounded plug, and 3-slot receptacle that will accept the plug on the appliance. The marked rating of the extension cord shall be equal to or greater than the electrical rating of the appliance.

The Power Supply Cord and plug must be connected to a separate 120 Volt AC, 60 Hz, 20 Amp, or more branch circuit, single grounded receptacle. The receptacle should be located inside the cabinet.



NOTES

1. If you have any questions about the grounding or electrical instructions, consult a qualified electrician or service person.
2. Neither Electrolux nor the dealer can accept any liability for damage to the microwave oven or personal injury resulting from failure to observe the correct electrical connection procedures.

ABOUT YOUR MICROWAVE OVEN

This Use and Care Manual is valuable: read it carefully and always save it for reference.

A good microwave cookbook is a valuable asset. Check it for microwave cooking principles, techniques, hints and recipes.

NEVER use the microwave oven without the turntable and support nor turn the turntable over so that a large dish could be placed in the microwave oven. The turntable will turn both clockwise and counterclockwise.

ALWAYS have food in the microwave oven when it is on to absorb the microwave energy.

When using the microwave oven at power levels below 100%, you may hear the magnetron cycling on and off. It is normal for the exterior of the microwave oven to be warm to the touch when cooking or reheating.

Condensation is a normal part of microwave cooking. Room humidity and the moisture in food will influence the amount of moisture that condenses in the microwave oven. Generally, covered foods will not cause as much condensation as uncovered ones. Ventilation openings must not be blocked.

The microwave oven is for food preparation only. It should not be used to dry clothes or newspapers.

Your microwave oven is rated 1000 watts by using the IEC Test Procedure. In using recipes or package directions, check food a minute or two before the minimum time and add time accordingly.

IMPORTANT SAFETY INSTRUCTIONS

- Do not use the wire rack when popping microwave popcorn. This can cause damage to your microwave oven. Remove the rack.
- Do not use the oven with the wire rack on the microwave floor as this could damage the oven.
- Do not handle the wire rack without using pot holders as the wire rack may be hot.
- Do not use the wire rack unless cooking or heating more than one food container at the same time.
- Do not store the wire rack in the microwave oven as damage to the oven could result if someone accidentally turns on the oven.
- Do not attempt to use any other wire racks besides the one supplied with this oven. The supplied rack is designed specifically for this oven and using any other rack can damage the oven.
- Do not cook food directly on the wire rack. Always place food in a microwave-safe container.
- Shield with small flat pieces of aluminum foil any thin areas of meat or poultry to prevent overcooking before dense, thick areas are cooked thoroughly.
- Stir foods from outside to center of dish once or twice during cooking, if possible.
- Turn foods over once during microwaving to speed cooking of such foods as chicken and hamburgers. Large items like roasts must be turned over at least once.
- Rearrange foods such as meatballs halfway through cooking both from top to bottom and from the center of the dish to the outside.
- Add standing time. Remove food from microwave oven and stir, if possible. Cover for standing time which allows the food to finish cooking without overcooking.
- Check for doneness. Look for signs indicating that cooking temperatures have been reached.

ABOUT MICROWAVE COOKING

- Arrange food carefully. Place thickest areas towards outside of dish.
- Watch cooking time. Cook for the shortest amount of time indicated and add more as needed. Food severely overcooked can smoke or ignite.
- Cover foods while cooking. Check recipe or cookbook for suggestions: paper towels, wax paper, microwave plastic wrap or a lid. Covers prevent spattering and help foods to cook evenly.

Doneness signs include:

- Food steams throughout, not just at edge.
- Center bottom of dish is very hot to the touch.
- Poultry thigh joints move easily.
- Meat and poultry show no pinkness.
- Fish is opaque and flakes easily with a fork.

ABOUT FOOD

FOOD	DO	DON'T
Eggs, sausages, nuts, seeds, fruits & vegetables	<ul style="list-style-type: none"> • Puncture egg yolks before cooking to prevent "explosion." • Pierce skins of potatoes, apples, squash, hot dogs and sausages so that steam escapes. 	<ul style="list-style-type: none"> • Cook eggs in shells. • Reheat whole eggs. • Dry nuts or seeds in shells.
Popcorn	<ul style="list-style-type: none"> • Use specially bagged popcorn for microwave cooking. • Listen while popping corn for the popping to slow to 1 or 2 seconds or use special popcorn pad. • Remove wire rack from oven before cooking popcorn. • Use ceramic tray on top of metal tray to pop popcorn. 	<ul style="list-style-type: none"> • Pop popcorn in regular brown bags or glass bowls. • Exceed maximum time on popcorn package. • Do not re-pop un-popped kernels. • Do not use wire rack when cooking popcorn. • Do not pop popcorn directly on metal turntable tray.
Baby food	<ul style="list-style-type: none"> • Transfer baby food to small dish and heat carefully, stirring often. Check temperature before serving. • Put nipples on bottles after heating and shake thoroughly. "Wrist" test before feeding. 	<ul style="list-style-type: none"> • Heat disposable bottles. • Heat bottles with nipples on. • Heat baby food in original jars.
General	<ul style="list-style-type: none"> • Cut baked goods with filling after heating to release steam and avoid burns. • Stir liquids briskly before and after heating to avoid "eruption." • Use deep bowl, when cooking liquids or cereals, to prevent boil-overs. 	<ul style="list-style-type: none"> • Heat or cook in closed glass jars or air tight containers. • Can in the microwave as harmful bacteria may not be destroyed. • Deep fat fry. • Dry wood, gourds, herbs or wet papers.

ABOUT UTENSILS AND COVERINGS

It is not necessary to buy all new cookware. Many pieces already in your kitchen can be used successfully in your new microwave oven. Make sure the utensil does not touch the interior walls during cooking.

Use these utensils for safe microwave cooking and reheating:

- glass ceramic (Pyroceram®), such as Corningware®
- heat-resistant glass (Pyrex®)
- microwave-safe plastics
- paper plates
- microwave-safe pottery, stoneware and porcelain
- browning dish (Do not exceed recommended preheating time. Follow manufacturer's directions.)

IMPORTANT SAFETY INSTRUCTIONS

These items can be used for short time reheating of foods that have little fat or sugar in them:

- wood, straw, wicker

DO NOT USE

- metal pans and bakeware
- dishes with metallic trim
- non-heat-resistant glass
- non-microwave-safe plastics (margarine tubs)
- recycled paper products
- brown paper bags
- food storage bags
- metal twist-ties

Should you wish to check if a dish is safe for microwaving, place the empty dish in the microwave oven and microwave on HIGH for 30 seconds. A dish which becomes very hot should not be used.

The following coverings are ideal:

- Paper towels are good for covering foods for reheating and absorbing fat while cooking bacon.
- Wax paper can be used for cooking and reheating.
- Plastic wrap that is specially marked for microwave use can be used for cooking and reheating. DO NOT allow plastic wrap to touch food. Vent so steam can escape.
- Lids that are microwave-safe are a good choice because heat is kept near the food to hasten cooking.
- Microwave oven cooking bags are good for large meats or foods that need tenderizing. DO NOT use metal twist ties. Remember to slit bag so steam can escape.

How to use aluminum foil in your microwave oven:

- Small flat pieces of aluminum foil placed smoothly on the food can be used to shield areas that are either defrosting or cooking too quickly.
- Foil should not come closer than one inch to any surface of the microwave oven.

Should you have questions about utensils or coverings, check a good microwave cookbook or follow recipe suggestions.

ACCESSORIES There are many microwave accessories available for purchase. Evaluate carefully before you purchase so that they meet your needs. A microwave-safe thermometer will assist you in determining correct doneness and assure you that foods have been cooked to safe temperatures. Electrolux is not responsible for any damage to the microwave oven when accessories are used.

ABOUT CHILDREN AND THE MICROWAVE

Children below the age of 7 should use the microwave oven with a supervising person very near to them. Between the ages of 7 and 12, the supervising person should be in the same room.

As with any appliance, close supervision by an adult is necessary when used by children.

At no time should anyone be allowed to lean or swing on the microwave oven door.

Children should be taught all safety cautions: use potholders, remove coverings carefully, pay special attention to packages that crisp food because they may be extra hot.

Do not operate the oven without the metal tray turntable. Don't assume that because a child has mastered one cooking skill he/she can cook everything.

Children need to learn that the microwave oven is not a toy. See Child Lock feature.

ABOUT SAFETY

- Check foods to see that they are cooked to the United States Department of Agriculture's recommended temperatures.

TEMP	FOOD
145°F (63°C)	- For beef, lamb or veal cut into steaks, chops or roasts, fish
160°F (71°C)	- For fresh pork, ground meat, seafood, egg dishes, frozen prepared food and beef, lamb or veal cut into steaks, chops or roasts
165°F (74°C)	- For leftover, ready-to-reheat refrigerated, deli and carry out "fresh" food, whole chicken or turkey, chicken or turkey breasts and ground poultry used in chicken or turkey burgers



NOTE

Do not cook whole, stuffed poultry. Cook stuffing separately to 165°F.

About Metal Tray Turntable:

Do not operate the oven without the metal tray turntable in place.

Verify that the metal tray turntable is properly positioned and turning when the oven is in use. Improper cooking or damage to the oven could result.

Only use the metal tray turntable designed for this oven. Do not substitute any other tray.

Always replace the metal tray in its proper position.

To test for doneness, insert a meat thermometer in a thick or dense area away from fat or bone. NEVER leave the thermometer in the food during cooking, unless it is approved for microwave oven use.

- ALWAYS use potholders to prevent burns when handling utensils that are in contact with hot food. Enough heat from the food can transfer through utensils to cause skin burns.
- Avoid steam burns by directing steam away from the face and hands. Slowly lift the farthest edge of a dish's covering and carefully open popcorn and oven cooking bags away from the face.
- Stay near the microwave oven while it's in use and check cooking progress frequently so that there is no chance of overcooking food.
- NEVER use the cavity for storing cookbooks or other items.
- Select, store and handle food carefully to preserve its high quality and minimize the spread of foodborne bacteria.
- Keep waveguide cover clean. Food residue can cause arcing and/or fires.
- Use care when removing items from the microwave oven so that the utensil, your clothes or accessories do not touch the safety door latches.
- Keep aluminum foil, used for shielding, at least 1 inch away from walls, ceiling and door.

PART NAMES

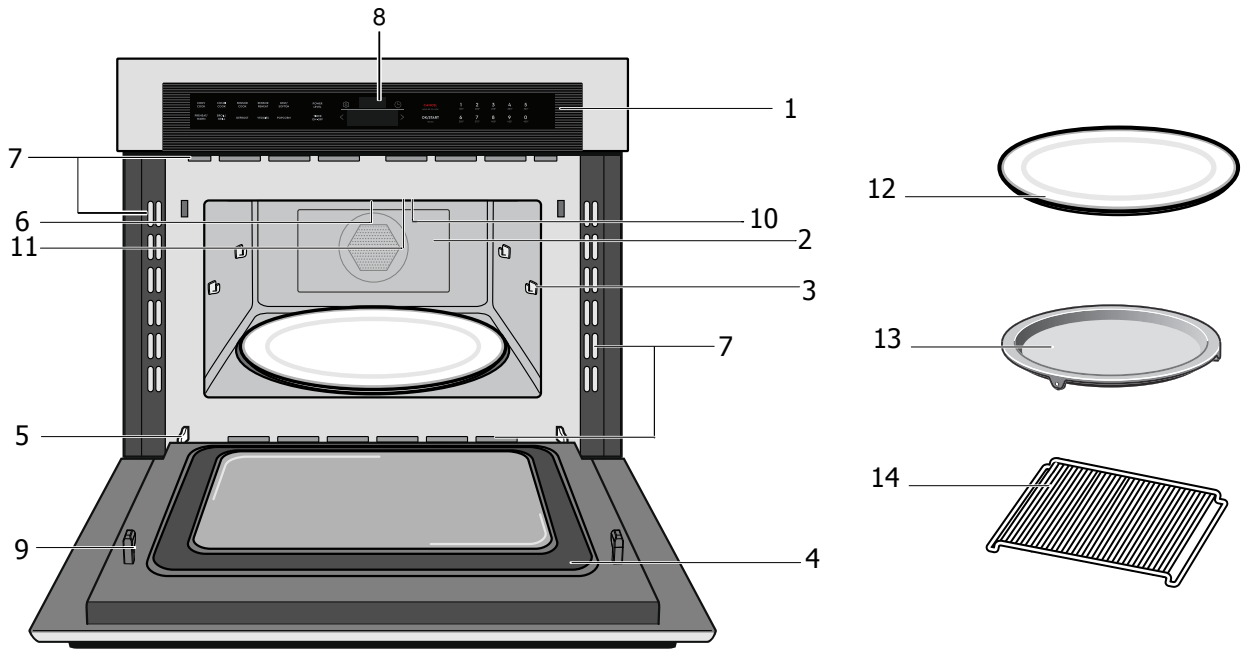

1. Auto-Touch control panel
2. Convection fan and element
The convection fan operates during all convection modes. When the oven is operating in a convection mode, the fan turns off automatically when the door is opened.
3. Rack holders (4)
4. Door gasket
5. Door hinges
6. Broil element
7. Oven vents
Warm air may be released from the top and bottom vents before, during and after cooking. It is normal to see steam escaping from these vents, and condensation may collect in this area. Do not block any vents, since they are important for air circulation.
8. Time display
Digital display, 99 minutes, 99 seconds.
9. Safety door latches
The oven will not operate unless the door is securely closed.
10. Oven light
The oven light turns off to save energy after one minute with the door open. To turn the light back on, close the door and open it again.
11. Waveguide cover
DO NOT REMOVE
12. Ceramic microwave tray
Use for microwave cooking and convection cooking. Food like a popcorn bag or potatoes can be directly placed on the ceramic tray.

Warning:

- The ceramic tray will get hot during convection cooking.
- Place the ceramic tray on top of the metal tray turntable.
- The ceramic tray can remain in the oven for all cooking modes, unless "Bake on Metal Tray" is required.
- Use ceramic tray on top of metal tray to pop popcorn.
- Do not pop popcorn directly on metal turntable tray.

13. Metal tray turntable with bake element below provides heat for food which particularly requires a lot of heat from underneath. Place the turntable with the rollers "A" as shown in the picture, on the carrier "B" in the middle of the cooking compartment floor. The turntable must sit straight on the carrier.

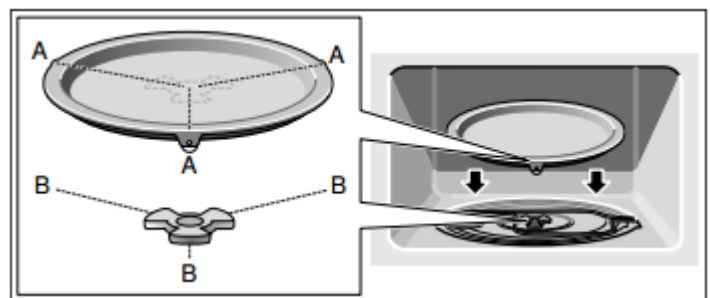

Note:

- Do not use the appliance if the turntable is not in place. Confirm that all parts are properly seated and that the turntable rotates freely when the microwave is operated. The metal tray turntable can support max. 12 lbs.
14. Wire rack
Use the wire rack with recess facing down for Convection, Keep Warm and to fit larger dishes into the oven cavity. Use it facing up (as shown) for Broil/Grill.

CONTROL PANEL

Number next to the control panel illustration indicates pages on which there are feature descriptions and usage information.

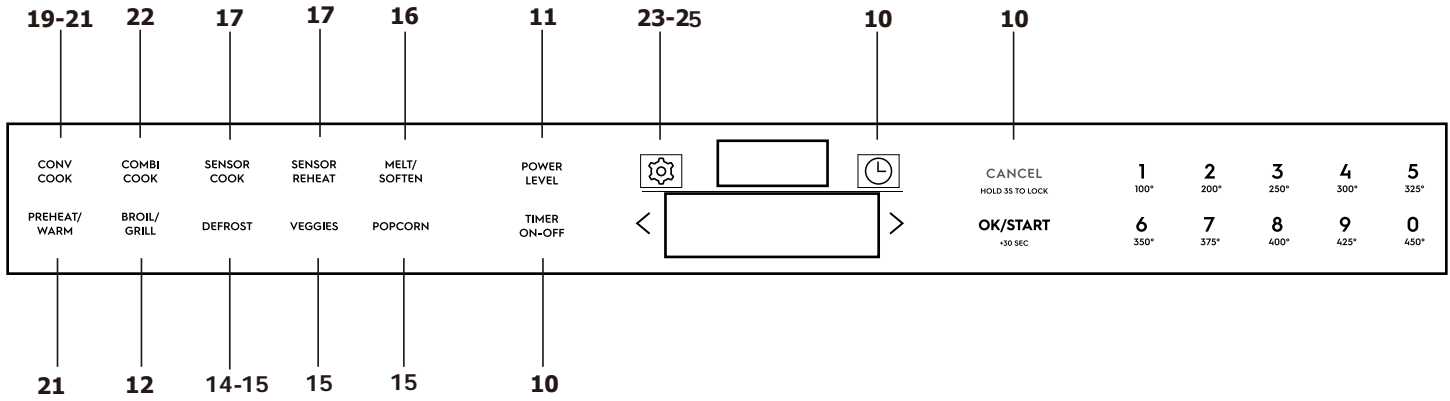

Words in the lower portion of the display will light to indicate what function is in progress.



NOTE

The left and right arrow keys will light when it is valid to adjust or select items using the arrow keys.

BEFORE OPERATING

1. Before operating your new oven make sure you read and understand this Use and Care Guide completely.





2. Before the Built-in Convection Microwave Oven can be used, follow these procedures:

- Plug in the oven. Close the door. The oven display will show 12:00.
- If no operation after 1 minute, the oven will show 12:01.

3. Set clock. See below.

TO SET THE CLOCK

- Suppose you want to enter the correct time of day 12:30 (A.M or P.M.).



Touch	Display Shows:
1. 	12:00
2.    	12:30
3. OK/START +30 SEC	12:30

NOTE

When clock is in set mode and after 3 seconds of no activity the clock will automatically set to the time in the display.

TO SET THE TIMER

- Set the timer for 3 minutes.

Touch	Display Shows:
1. TIMER	0:00 MIN : SEC
2.   	3:00 MIN : SEC
3. TIMER	3:00 MIN : SEC

Time counting down

NOTE

1. Opening the door during timer countdown will not pause the running timer.
2. To cancel the active timer, press the CANCEL key once.
3. Arrow keys will display when they are valid to use.

CANCEL

Press the **CANCEL** to:

1. Erase if you make a mistake during programming.
2. Cancel timer and the signal after cooking.
3. Cancel a program during cooking, press once.

LOCK-OUT FUNCTION FOR CHILDREN

Lock: In waiting state, press **CANCEL** pad for more than 3 seconds there will be 1"beep" denoting that entering into the children-lock state and the screen will display "LOCKED"for 2 seconds.



Un-lock: In lock state, press **CANCEL** pad for more than 3 seconds there will be 1"beep"denoting that the lock is released, and the screen will display "UNLOCK"for 2 seconds.

MANUAL COOKING

USING ONE TOUCH START

This is a time saving pad that will automatically start cooking 2 seconds after selected. Numeric key 1 to 9 can be touched for a 1 minute to 9 minutes automatic start cooking feature.

- **Suppose you want to cook 3 minutes at 100% power.**

Touch	Display Shows:
1. 	 Time counting down automatically after 2 seconds



NOTE

Arrow keys will display when they are valid to use.

USING ADD 30 SEC.

This is a time-saving pad. It is a simplified feature that lets you quickly set and start microwave cooking at 100% power.

- **Suppose you want to set and start microwave cooking at 100% for 30 SEC.**

Touch	Display Shows:
1. OK/START +30 SEC	 Time counting down









NOTE

1. The cooking time can be extended for 30 seconds by pressing add 30 sec key .
The cooking time is extended to a maximum of 99 minutes 99 seconds .
2. Arrow keys will display when they are valid to use.
3. "Food" will be displayed if a quick start cooking cycle or +30 sec. key is pressed more than 5 minutes after the microwave oven door is closed. You must open then close the door again to clear "Food" from the display.

SETTING TIMED COOKING WITH POWER LEVEL

This feature lets you program a specific cook time and power. For best results, there are 11 power level settings in addition to HIGH (100%) power. Refer to the "Microwave Power Levels" table.

- **Suppose you want to cook for five minutes at 70% power.**

Touch	Display Shows:
1.   	
2. POWER	PWR 100%
3. 	PWR 70%
4. OK/START +30 SEC	 Time counting down



NOTE

If you do not select a power level the oven will automatically cook at HIGH (100%) power.
Arrow keys will display when they are valid to use.

MANUAL COOKING

SETTING TWO-STAGE COOKING

For best results, some recipes call for different power levels during a cook cycle. You can program your oven for two power level stages during the cooking cycle.

- **To set a 2-stage cook cycle. The first stage is a 2 minute cook time at 30% cook power then a 4 minute cook time at 70% cook power.**

Touch	Display Shows:
1. (2) (0) (0)	2:00 MIN : SEC
2. POWER	PWR 100%
3. (3)	PWR 30%
4. POWER	" ENTER STAGE 2 POWER PRESS OK "
	will show on the display.
5. (7)	PWR 70%
6. OK/START	+30 SEC
	" ENTER STAGE 2 COOK TIME PRESS START "
	will show on the display.
7. (4) (0) (0)	4:00 MIN : SEC
8. OK/START	2:00 MIN : SEC
	+30 SEC
	Time counting down

When the first stage finishes, the oven will beep. "FIRST STAGE DONE" will show on the display. The second stage starts automatically.



NOTE

Arrow keys will display when they are valid to use.

Broil/Grill COOKING

The broil / grill touch pad lets you broil at a high or low setting and also cook fresh and frozen pizza. See table below.

- **Suppose you want to broil or grill for 20 minutes with the low level.**

Touch	Display Shows:
1. BROIL / GRILL	BROIL HIGH
2. BROIL / GRILL	BROIL LOW
3. OK/START	0:00 MIN : SEC
	+30 SEC
4. (2) (0) (0) (0)	20:00 MIN : SEC
5. OK/START	20:00 MIN : SEC
	+30 SEC
	Time counting down

KEY PRESS	Food
BROIL/GRILL x1	Grill High
BROIL/GRILL x2	Grill Low
BROIL/GRILL x3	Fresh Pizza
BROIL/GRILL x4	Frozen Pizza

Pizza tips

- For fresh pizza use a pizza paddle for sliding the pizza on and from the metal turntable.
- If using a pizza paddle, sprinkle the paddle liberally with cornmeal for ease in transferring the dough to the metal turntable.
- Maximum size is 12 inches for fresh and frozen pizzas.
- Avoid using a pizza stone as it can damage the oven.

MANUAL COOKING

MICROWAVE POWER LEVELS

For best results, some recipes call for different cook powers. The lower the cook power, the slower the cooking. Each number from 1 to 9 stands for a different percentage of full cook power.

The following table gives the percentage of cook power each number pad stands for, and the cook power name usually used.

The table also tells you when to use each cook power. Follow recipe or food package instructions if available.

NOTE: Refer to a reliable cookbook for cooking times based on the 1000 Watt cook power of your microwave oven.

COOK POWER	LEVEL	WHEN TO USE IT
100% of full power	High	<ul style="list-style-type: none">• Quickly heating convenience foods and foods with high water content, such as soup and beverages.• Cooking tender cuts of meat, ground meat or chicken.
9 = 90% of full power		<ul style="list-style-type: none">• Heating cream soups.
8 = 80% of full power		<ul style="list-style-type: none">• Heating rice, pasta, or casseroles.
7 = 70% of full power	Medium-High	<ul style="list-style-type: none">• Cooking and heating foods that need a Cook Power lower than High (for example, whole fish and meat loaf) or when food is cooking too fast.• Reheating a single serving of food.
6 = 60% of full power		<ul style="list-style-type: none">• Cooking that requires special care, such as cheese and egg dishes, pudding, and custards.• Finishing cooking casseroles.
5 = 50% of full power	Medium	<ul style="list-style-type: none">• Cooking ham, whole poultry, and pot roasts.• Simmering stews.
4 = 40% of full power		<ul style="list-style-type: none">• Melting chocolate.• Heating pastries.
3 = 30% of full power	Medium-Low, Defrost	<ul style="list-style-type: none">• Manually defrosting pre-cooked and other foods, such as bread, fish, meats and poultry.
2 = 20% of full power		<ul style="list-style-type: none">• Softening butter, cheese, and ice cream.
1 = 10% of full power	Low	<ul style="list-style-type: none">• Keeping food warm.• Taking chill out of fruit.
0 = 0% of full power	None	<ul style="list-style-type: none">• Standing time in oven.

USING AUTO DEFROST

Three defrost sequences are preset in the oven. The auto defrost feature provides you with the best defrosting method for frozen foods. The cooking guide will show you which defrost sequence is recommended for the food you are defrosting.

For added convenience, the Auto Defrost includes a built-in beep mechanism that reminds you to check, turn over, separate, or rearrange the food in order to get the best defrost results. Three different defrosting levels are provided:

1. MEAT
2. POULTRY
3. FISH

Available weight is 0.1-6.0 lbs.

- Suppose you want to defrost 0.6 lbs of meat.

Touch	Display Shows:
1. DEFROST	MEAT
2. OK/START +30 SEC	0.0 Lb
3. (6)	0.6 Lb
4. OK/START +30 SEC	MEAT Then time will count down



NOTE

The oven will beep during the DEFROST cycle. At this time, open the door and turn, separate, or rearrange the food. Remove any portions that have thawed. Return frozen portions to the oven and touch START to resume the defrost cycle.

OPERATING TIPS

- For best results, remove fish, shellfish, meat, and poultry from its original closed paper or plastic package (wrapper). Otherwise, the wrap will hold steam and juice close to the foods which can cause the outer surface of the foods to cook.
- For best results, roll your ground meat into a ball before freezing. During the DEFROST cycle, the microwave will signal when it is time to turn the meat over. Scrape off any excess frost from the meat and continue defrosting.
- Place foods in a shallow container or on a microwave roasting rack to catch drippings.

This table shows food type selections and the weights you can set for each type. For best results, loosen or remove covering on food.

Weight conversion table

Equivalent Weight	
OUNCES	DECIMAL WEIGHT
1.6	.10
3.2	.20
4.0	.25 One-Quarter Pound
4.8	.30
6.4	.40
8.0	.50 One-Half Pound
9.6	.60
11.2	.70
12.0	.75 Three-Quarters Pound
12.8	.80
14.4	.90
16.0	1.0 One Pound



NOTE

If between two decimal weights, choose the lower weight for the best defrosting results.

DEFROSTING TIPS

- When using Auto Defrost, use a microwave safe dish. The weight to be entered is the net weight (the weight of the food minus the container).
- Before starting, make sure to remove any and all metal twist-ties that often come with frozen food bags, and replace them with strings or elastic bands.
- Open containers, such as cartons, before placing in the oven.
- Always slit or pierce plastic pouches or packaging.
- If food is foil wrapped, remove foil and place food in a suitable container.

AUTO COOKING

- Slit the skin of skinned food, such as sausage.
 - Bend plastic pouches of food to ensure even defrosting.
 - Always under estimate defrosting time. If defrosted food is still icy in the center, return it to the microwave oven for more defrosting.
 - The length of defrosting time varies according to how solidly the food is frozen.
- The shape of the package affects how quickly food will defrost. Shallow packages will defrost more quickly than a deep block.
- As food begins to defrost, separate the pieces. Separated and rearranged pieces defrost more easily.
- Turn over food at beep during defrosting or standing time.
 - Break apart and remove food as required.
 - For more information on defrosting see USDA.gov

SETTING POPCORN

The Popcorn quick touch pad lets you pop 3.3, 3.0, 1.75 ounce bags of commercially packaged microwave popcorn. Pop only one package at a time. If you are using a microwave popcorn popper, follow manufacturer's instructions.

- **Suppose you want to pop a 3.3 oz. popcorn**

Touch	Display Shows:
1. POPCORN	3.3 0Z
2. OK/START +30 SEC	POPCORN Then time will count down

Key press	Selection	Amount
Popcorn	3.3	3.3 oz (94g)
Popcorn	3.0	3.0 oz (85g)
Popcorn	1.75	1.75 oz (50g)

NOTE

1. Remove wire rack from oven before cooking popcorn. Do not use regular paper bags. Do not re-pop un-popped kernels. Do not pop popcorn in glass cookware.
2. Use ceramic tray on top of metal tray to pop popcorn.
3. Do not pop popcorn directly on metal turntable tray.
4. Do not leave microwave oven unattended while popping corn.

SETTING VEGGIES

The Veggies quick touch pad lets you cook fresh and frozen vegetables.

- **Suppose you want to cook frozen veggies.**

Touch	Display Shows:
1. VEGGIES	POTATO
2. VEGGIES	FRESH VEGGIES
3. VEGGIES	FROZEN VEGGIES
4. OK/START +30 SEC	FROZEN VEGGIES Then time will count down

Key	Food	
Veggies x1	Potato	1-4
Veggies x2	Fresh	1-4 Cups
Veggies x3	Frozen	1-4 Cups

Touch Veggie key repeatedly to switch between potato, Fresh and Frozen veggies selections.

SETTING MELT/SOFTEN

- Suppose you want to melt 8 oz. of Chocolate.

1. MELT/ SOFTEN MELT BUTTER

2. MELT/ SOFTEN MELT CHOCOLATE

3. OK/START 2 07
+30 SEC

4. (8) 8 07

5. OK/START MELTCHOCOLATE
+30 SEC
Then time will count down

MELT/SOFTEN TABLE

CATEGORY	DIRECTION	AMOUNT
BUTTER	Unwrap and place in microwavable container. Stir at the end of cooking to complete melting.	1 or 2 sticks
CHOCOLATE	Chocolate chips or squares of baking chocolate may be used. Unwrap squares and place in microwavable container. Stir at the end of cycle to complete melting.	2, 4 or 8 oz.
ICE CREAM	Place container in oven. Ice cream will be soft enough to make scooping easier.	1 pint, 1/2 gallons
CREAM CHEESE	Unwrap and place in microwavable container.	3 or 8 oz.

Key	Foo	Amount	Key
Melt / Soften x1	Melt Butter	1 stick	1
		2 sticks	2
Melt / Soften x2	Melt Chocolate	2 oz.	2
		4 oz.	4
Melt / Soften x3	Soften Ice Cream	8 oz.	8
		1 pint	1
Melt / Soften x4	Soften Cream Cheese	1/2 gallons	2
		3 oz.	3
		8 oz.	8



NOTE

Arrow keys will display when they are valid to use.

SENSOR COOKING

SENSOR OPERATING INSTRUCTIONS

Sensor Cook allows you to cook most of your favorite foods without selecting cooking times and power levels. The display will show the selected food type during the initial sensing period.

The oven automatically determines required cooking time for each food item. When the internal sensor detects a certain amount of humidity coming from the food, it will tell the oven how much longer to heat. The display will show the remaining heating time. For best results for cooking by Sensor, follow these recommendations.

1. Food cooked with the sensor system should be at normal storage temperature.
2. Always use microwavable containers.
3. Match the amount to the size of the container.
Fill containers at least half full for best results.

USING SENSOR COOK

Using SENSOR COOK lets you cook common microwave-prepared foods without needing to program times and cook powers.

- **Suppose you want to cook fish seafood with sensor.**

Touch	Display Shows:
1. SENSOR COOK	BACON
2. SENSOR COOK	FROZEN ENTREE
3. SENSOR COOK	WHITE RICE
4. SENSOR COOK	GROUND MEAT
5. SENSOR COOK	FISH SEAFOOD
6. OK/START +30 SEC	FISH SEAFOOD

Sensor Cook selections are made by touching the Sensor Cook key multiple times.

4. Be sure the outside of the cooking container and the inside of the microwave oven are dry before placing food in the oven. Beads of moisture turning into steam can mislead the sensor.
5. Foods should always be covered with microwavable plastic wrap, waxed paper, or a lid. Never use tight-sealing plastic covers. They can prevent steam from escaping and cause food to overcook.
6. Do not open the door or touch the CANCEL key during the sensing time. When sensing time is over, the oven beeps and the remaining cooking time will appear in the display window. At this time you can open the door to stir, turn, or rearrange the food.

USING SENSOR REHEAT

Using SENSOR REHEAT lets you reheat common microwave-prepared foods without selecting cooking times and power levels.

- **Suppose you want to reheat soup sauce.**

Touch	Display Shows:
1. SENSOR REHEAT	BEVERAGE
2. SENSOR REHEAT	SOUP SAUCE
3. OK/START +30 SEC	SOUP SAUCE

Sensor Reheat selections are made by touching the Sensor Reheat key multiple times.

SENSOR COOKING

SENSOR COOK TABLE

CATEGORY	DIRECTION	AMOUNT
Bacon	Place bacon strips on a microwave bacon rack for best results. (Use dinner plate lined with paper towels if rack is not available). If more time is needed to reach desired doneness, +30s button can be used.	1-3 slices
Frozen Entree	Follow package instructions.	10 oz./ 20 oz.
White Rice	Place rice and twice as much liquid (water, chicken or vegetable stock) in a 2 quart microwave dish. Cover with plastic wrap and vent. After cooking, allow to stand for 10 minutes. Stir for fluffier rice.	2-5 cups Use medium or long grain rice. Cook instant rice according to directions on the package.
Ground Meat	Use this setting to cook ground beef or turkey patties as an ingredient to be used in casseroles. microwave safe dish, turnover, separate and rearrange. After cooking, let stand, covered, for 2 to 3 minutes.	8-24 oz.
Fish/Seafood	Arrange in ring around shallow glass dish (roll fillet with edges underneath). Cover with plastic wrap. After cooking, let stand, covered, 3 minutes.	8-20 oz.

SENSOR REHEAT TABLE

CATEGORY	DIRECTION	AMOUNT
Beverage	Do not cover.	1-3 cups
Soup/Sauce	Place in shallow microwavable casserole. Cover with vented plastic wrap. After cooking, stir and let stand 3 minutes.	1-2 cups
Pizza		1-4 Slices
Dinner Plate	Place on a low plate. Cover with vented plastic wrap. Let stand 3 minutes after cooking.	1 plate
Casserole/ Pasta	Place in a microwavable bowl or casserole. Cover with vented plastic wrap. After cooking, stir and let stand 3 minutes.	1 serving

CONVECTION COOKING

TIPS FOR CONVECTION COOKING

This section gives you cooking instructions and procedures for operating each convection function. Please read these instructions carefully.

Convection cooking circulates hot air through the oven cavity with a fan. The constantly moving air surrounds the food to heat the outer portion quickly, creating even browning and sealed-in flavor by the constant motion of hot air over the food surfaces. Your oven uses convection cooking whenever you use the Convection Button. **DO NOT USE THE OVEN WITHOUT THE TURNTABLE IN PLACE.**

1. **Do not cover** turntable or metal rack with aluminum foil. It interferes with the flow of air that cooks the food.
2. **Round pizza pans** are excellent cooking utensils for many convection-only items. Choose pans that do not have extended handles.
3. **Use convection cooking** for items like breads, cookies, pizza, and for some meat and fish.
4. **You do not need to use** any special techniques to adapt your favorite oven recipes to convection.
5. **When baking** cakes, cookies, breads, rolls, or other baked foods, most recipes call for preheating. Preheat the empty oven just as you do a regular oven. You can start heavier dense foods such as meats and poultry without preheating.
6. **All oven safe** cookware or metal utensils can be used in convection cooking.
7. **Use metal utensils** only for convection cooking. Never use for microwave or combination cooking since arcing and damage to the oven may occur.
8. **After preheating**, if you do not open the door, the oven will automatically hold at the preheated temperature for 30 minutes.



CAUTION

- The oven cavity, door, metal turntable tray, ceramic tray, metal rack, and cooking utensils will become very hot. **USE THICK OVEN GLOVES** when removing the food, cooking utensils, metal turntable tray, ceramic tray, metal rack from the oven after convection cooking.
- Do not use lightweight plastic containers, plastic wraps, or paper products during any convection.

CONVECTION BAKE

- **Suppose you want to bake 33 min at 375 degree.**

Touch	Display Shows:
1. CONV COOK	BAKE
2. OK/START +30 SEC	325°
3. (7)	375°
4. OK/START +30 SEC	0:00 MIN : SEC
5. (3) (3) (0) (0)	33:00 MIN : SEC
6. OK/START +30 SEC	33:00 MIN : SEC

Time counting down

Bake (Deg F)	Key
250	3
300	4
325(Default)	5
350	6
375	7
400	8



NOTE

Arrow keys will display when they are valid to use.

CONVECTION COOKING

CONVECTION ROAST

- Suppose you want to roast 33 min at 375 degree.

Touch	Display Shows:
1. CONV COOK	BAKE
2. CONV COOK	ROAST
3. OK/START +30 SEC	350°
4. (7)	375°
5. OK/START +30 SEC	0:00 MIN : SEC
6. (3) (3) (0) (0)	33:00 MIN : SEC
7. OK/START +30 SEC	33:00 MIN : SEC

Time counting down

Roast (Deg F)	Key
300	4
325	5
350(Default)	6
375	7
400	8
425	9
450	0



NOTE

Arrow keys will display when they are valid to use.

CONVECTION COOKING

CONVECTION PREHEAT

- Suppose you want to preheat 350 degree.

Touch	Display Shows:
1. PREHEAT/ WARM	PREHEAT
2. OK/START +30 SEC	325°
3. (6)	350°
4. OK/START +30 SEC	PREHEAT

When set preheat temp is reached.

OVEN READY



NOTE

The temperature range has 10 steps from 100° F to 450° F.

Preheat (Deg F)	Key
100	1
200	2
250	3
300	4
325 (Default)	5
350	6
375	7
400	8
425	9
450	0

CONVECTION KEEP WARM

- Suppose you want to keep warm for 33 min.

Touch	Display Shows:
1. PREHEAT/ WARM	PREHEAT
2. PREHEAT/ WARM	WARM
3. OK/START +30 SEC	0:00 MIN : SEC
4. (3) (3) (0) (0)	33:00 MIN : SEC
5. OK/START +30 SEC	33:00 MIN : SEC

Time counting down

CONVECTION COOKING GUIDELINES

1. Dark or non-shiny finishes, glass, absorb heat which may result in dry, crisp crusts.
2. Preheating the oven is recommended when baking foods by convection.
3. To prevent uneven heating and save energy, open the oven door to check food as little as possible.

Notes:

- Follow package or recipe instructions.
- You need to adjust time according to the food condition or your preference. Check for desired doneness at the minimum time.

TIPS FOR COMBINATION COOKING

This section gives you instructions to operate each COMBI COOK function. Please read these instructions carefully. Sometimes combination microwave-convection cooking is suggested to get the best cooking results. This cooking process also leaves meats juicy on the inside and crispy on the outside. In combination cooking, the convection heat and microwave energy alternate automatically.

CONVECTION COOKING

HELPFUL HINTS FOR COMBINATION COOKING

1. COMBI BAKE

- Check for doneness after cooking time is up. If not completely done, let stand in oven for a few minutes to complete cooking.
- The Combi Bake table is a guideline for your reference. You will need to adjust the time according to the food condition or your preference.
- Check doneness at the minimum time.
- Use a pan that is safe for microwave and oven cooking.

2. COMBI ROAST

- Meats may be roasted directly in a shallow pan placed on the provided rack.
- Less tender cuts of beef can be roasted and tenderized using oven cooking bags.
- The Combi Roast table is a guideline for your reference. You will need to adjust the time according to the food condition or your preference.
- Check doneness at the minimum time.
- Use a meat thermometer to check the internal temperature of the food.
- Use a pan that is safe for microwave and oven cooking.



CAUTION

1. All cookware used for combination cooking must be BOTH microwave-safe and oven-safe.
2. During combination baking, some baking cookware may cause arcing when it comes in contact with the oven walls or metal accessory racks. Arcing is a discharge of electricity that occurs when microwaves come in contact with metal.
 - If arcing occurs, immediately stop the cooking cycle and place a microwavable safe dish between the pan and the metal rack.
 - We recommend you use the metal rack supplied with your oven.
 - If arcing occurs with other baking cookware, do not use them for combination cooking.

COMBI COOK BAKE

- Suppose you want to bake 33 min at 350 degree using Combi cook.

Touch	Display Shows:
1. COMBI COOK	BAKE
2. OK/START +30 SEC	325°
3. (6)	350°
4. OK/START +30 SEC	0:00 MIN : SEC
5. (3) (3) (0) (0)	33:00 MIN : SEC

6. OK/START
+30 SEC

33:00
MIN : SEC

Time counting down

Bake (Degrees F)	Key	Microwave Setting
250	3	10%
300	4	10%
325(Default)	5	10%
350	6	10%
375	7	10%
400	8	10%



NOTE

Arrow keys will display when they are valid to use.

COMBI COOK ROAST

- Suppose you want to roast 33 min at 350 degree using Combi cook.

Touch	Display Shows:
COMBI 1. COOK	BAKE
COMBI 2. COOK	ROAST
3. OK/START +30 SEC	350°
4. OK/START +30 SEC	0:00 MIN : SEC
5. (3) (3) (0) (0)	33:00 MIN : SEC
6. OK/START +30 SEC	33:00 MIN : SEC

Time counting down

Roast(Degrees F)	Key	Microwave Setting
300	4	30%
325	5	30%
350 (Default)	6	30%
375	7	30%
400	8	30%
425	9	30%
450	0	30%



NOTE

Arrow keys will display when they are valid to use.

CONVENIENT FEATURES

USER PREF

Touch the User Pref key multiple times to scroll to the desired setting function.

Key	Food	Level
User Pref x 1	Audio	Low / Med / High / OFF
User Pref x 2	Weight	Lbs / KG
User Pref x 3	Language	English / French
User Pref x 4	Clock Display ON	ON / OFF
User Pref x 5	Demo Mode	ON / OFF

SETTING AUDIO LOW/MED/HIGH/OFF



- Suppose you want to turn on the Audio Off.

Touch	Display Shows:
1. 	AUDIO
2. OK/START +30 SEC	MED
3. >	HI
4. >	OFF
5. >	Lo
6. OK/START +30 SEC	Lo

Display for 2 seconds then clear.

SETTING WEIGHT LBS/KG

- Suppose you want to toggle weight between pounds & kilograms.

Touch	Display Shows:
1. 	AUDIO
2. 	WEIGHT
3. OK/START +30 SEC	LBS
4. >	KG
5. OK/START +30 SEC	KG

Display for 2 seconds then clear.

CONVENIENT FEATURES

SETTING LANGUAGE MODE





- Suppose you want to enter Language Mode.

Touch	Display Shows:
1. 	AUDIO
2. 	WEIGHT
3. 	LANGUAGE
4. OK/START +30 SEC	ENGLISH
5. >	FRENCH
6. OK/START +30 SEC	FRANCAIS

Display for 2 seconds then clear.

TURNING CLOCK DISPLAY OFF

- Suppose you want to turn the clock display off.

Touch	Display Shows:
1. 	AUDIO
2. 	WEIGHT
3. 	LANGUAGE
4. 	CLOCK DISPLAY ON
5. OK/START +30 SEC	ON
6. >	OFF
7. OK/START +30 SEC	OFF

Display for 2 seconds then clear.

CONVENIENT FEATURES

SETTING DEMO MODE

- Suppose you want to enter Demo Mode. When Demo mode is ON programming functions will work in a rapid countdown mode with no cooking power.

Touch	Display Shows:
1. 	AUDIO
2. 	WEIGHT
3. 	LANGUAGE
4. 	CLOCK DISPLAY ON
5. 	DEMO
6. OK/START +30 SEC	OFF
7. >	ON
8. OK/START +30 SEC	ON

Display for 2 seconds then clear.

CLEANING AND CARE



WARNING

Disconnect the power cord before cleaning or leave the door open to deactivate the oven during cleaning.

EXTERIOR

The outside surface is precoated steel and plastic. Clean the outside with mild soap and water; rinse and dry with a soft cloth. Do not use any type of household or abrasive cleaner.

DOOR

Disconnect the power cord or deactivate the oven with setting Child Lock before cleaning to prevent unexpected manipulation.

Wipe the window on both sides with a soft cloth to remove any spills or splatters. Metal parts will be easier to maintain if wiped frequently with a soft cloth. Avoid the use of spray and other harsh cleaners as they may stain, streak or dull the door surface.

EASY CARE™ STAINLESS STEEL / SMUDGE_PROOF™ STAINLESS STEEL / BLACK STAINLESS STEEL(SOME MODELS)

Your microwave oven (some models) may have a Stainless Steel finish or coating. Clean the stainless with warm soapy water using a clean sponge or cloth. Rinse with clean water and dry with a soft clean cloth. **DO NOT** use ANY store bought cleaners like Stainless Steel cleaners or any other types of cleaners containing any abrasive, chlorides, chlorines or ammonia. It is recommended to use mild dish soap and water or a 50/50 solution of water and vinegar.

INTERIOR

Cleaning is easy because little heat is generated to the interior surfaces; therefore, there is no baking and setting of spills or spattering. To clean the interior surfaces, wipe with a soft cloth and warm water. **DO NOT USE ABRASIVE OR HARSH CLEANERS OR SCOURING PADS.** For heavier soil, use baking soda or a mild soap; rinse thoroughly with hot water. The rack can be cleaned with hot soapy water, rinsed and dried.

WAVEGUIDE COVER

The waveguide cover is located on the ceiling in the microwave oven cavity. It is made from mica so requires special care. Keep the waveguide cover clean to assure good microwave oven performance. Carefully wipe with a damp cloth any food splatters from the surface of the cover immediately after they occur. Built-up splashes may overheat and cause smoke or possibly catch fire. **DO NOT REMOVE THE WAVEGUIDE COVER.**

ODOR REMOVAL

Occasionally, a cooking odor may remain in the microwave oven. To remove, combine 1 cup water, grated peel and juice of 1 lemon and several whole cloves in a 2-cup glass measuring cup. Boil for several minutes using 100% power. Allow to set in microwave oven until cool. Wipe interior with a soft cloth.

METAL TURNTABLE TRAY AND CERAMIC TRAY

The metal turntable tray and ceramic tray can be removed for easy cleaning. Wash them in mild, sudsy water. They are also dishwasher-proof. Use upper rack of dishwasher. The turntable motor shaft is not sealed, so excess water or spills should be wiped up immediately.

TOUCH CONTROL PANEL

Care should be taken in cleaning the touch control panel. If the control panel becomes soiled, open the microwave oven door before cleaning. Wipe the panel with a cloth dampened slightly with water only. Dry with a soft cloth. Do not scrub or use any sort of chemical cleaners. Close door and touch **CANCEL.**

SERVICE CALL CHECK

Please check the following before calling for service:

Place one cup of water in a glass measuring cup in the microwave oven and close the door securely.
Operate the microwave oven for one minute at HIGH 100%.

- A** Does the microwave oven light come on? YES _____ NO _____
- B** Does the turntable rotate? (It is normal for the turntable to turn in either direction.) YES _____ NO _____
- C** Is the water in the microwave oven warm? YES _____ NO _____

If “NO” is the answer to any of the above questions, please check electrical outlet, fuse and/or circuit breaker. If they are functioning properly, CONTACT YOUR NEAREST ELECTROLUX AUTHORIZED SERVICER.

A microwave oven should never be serviced by a “do-it-yourself” repair person.

NOTES

1. If time appearing in the display is counting down very rapidly, check Demonstration Mode in the CONVENIENT FEATURES section to make sure DEMO Mode is OFF.
2. If the oven is set for more than 30 minutes at, 100 percent power level, after the first 30 minutes the power level will automatically adjust itself to 80 percent power to avoid overcooking.

SPECIFICATIONS

AC Line Voltage:	Single phase 120V, 60Hz, AC only
AC Power Required:	1750W 20A
Output Power*:	1000 W
Output Power*(convection):	1700W
Frequency:	2450 MHz
Outside Dimensions (including handle):	19.08" X 29.88" X 25.44"
Cavity Dimensions:	9.84" X 16.54" X 16.54"
Microwave oven Capacity***:	1.6 Cu.Ft.
Cooking Uniformity:	Turntable
Weight:	Approx. (net) 92.59 lb, (gross) 105.16 lb
Oven Light:	1*1.5 W LED

* The International Electrotechnical Commission’s standardized method for measuring output wattage. This test method is widely recognized.

** This is the classification of ISM (Industrial, Scientific and Medical) equipment described in the International Standard CISPR11.

*** Internal capacity is calculated by measuring maximum width, depth and height. Actual capacity for holding food is less.

In compliance with standards set by:

FCC - Federal Communications Commission Authorized.

DHHS - Complies with Department of Health and Human Services (DHHS) rule, CFR, Title 21, Chapter I, Subchapter J.



- This symbol on the nameplate means the product is listed by Underwriters Laboratories, Inc.



- This symbol on the nameplate means the product is listed by Underwriters Laboratories, Inc. for use in USA or Canada.

WARRANTY

Your appliance is covered by a one year limited warranty. For one year from your original date of purchase, Electrolux will pay all costs for repairing or replacing any parts of this appliance that prove to be defective in materials or workmanship when such appliance is installed, used and maintained in accordance with the provided instructions.

Exclusions

This warranty does not cover the following:

Products with original serial numbers that have been removed, altered or cannot be readily determined.

Product that has been transferred from its original owner to another party or removed outside the USA or Canada.

Rust on the interior or exterior of the unit.

Products purchased "as-is" are not covered by this warranty.

Food loss due to any refrigerator or freezer failures.

Products used in a commercial setting.

Service calls which do not involve malfunction or defects in materials or workmanship, or for appliances not in ordinary household use or used other than in accordance with the provided instructions.

Service calls to correct the installation of your appliance or to instruct you how to use your appliance.

Expenses for making the appliance accessible for servicing, such as removal of trim, cupboards, shelves, etc., which are not a part of the appliance when it is shipped from the factory.

Service calls to repair or replace appliance light bulbs, air filters, water filters, other consumables, or knobs, handles, or other cosmetic parts.

Surcharges including, but not limited to, any after hour, weekend, or holiday service calls, tolls, ferry trip charges, or mileage expense for service calls to remote areas, including the state of Alaska.

Damages to the finish of appliance or home incurred during installation, including but not limited to floors, cabinets, walls, etc.

Damages caused by: services performed by unauthorized service companies; use of parts other than genuine Electrolux parts or parts obtained from persons other than authorized service companies; or external causes such as abuse, misuse, inadequate power supply, accidents, fires, or acts of God.

DISCLAIMER OF IMPLIED WARRANTIES; LIMITATION OF REMEDIES

CUSTOMER'S SOLE AND EXCLUSIVE REMEDY UNDER THIS LIMITED WARRANTY SHALL BE PRODUCT REPAIR OR REPLACEMENT AS PROVIDED HEREIN. CLAIMS BASED ON IMPLIED WARRANTIES, INCLUDING WARRANTIES OF MERCHANTABILITY OR FITNESS FOR A PARTICULAR PURPOSE, ARE LIMITED TO ONE YEAR OR THE SHORTEST PERIOD ALLOWED BY LAW, BUT NOT LESS THAN ONE YEAR. ELECTROLUX SHALL NOT BE LIABLE FOR CONSEQUENTIAL OR INCIDENTAL DAMAGES SUCH AS PROPERTY DAMAGE AND INCIDENTAL EXPENSES RESULTING FROM ANY BREACH OF THIS WRITTEN LIMITED WARRANTY OR ANY IMPLIED WARRANTY. SOME STATES AND PROVINCES DO NOT ALLOW THE EXCLUSION OR LIMITATION OF INCIDENTAL OR CONSEQUENTIAL DAMAGES, OR LIMITATIONS ON THE DURATION OF IMPLIED WARRANTIES, SO THESE LIMITATIONS OR EXCLUSIONS MAY NOT APPLY TO YOU. THIS WRITTEN WARRANTY GIVES YOU SPECIFIC LEGAL RIGHTS. YOU MAY ALSO HAVE OTHER RIGHTS THAT VARY FROM STATE TO STATE.

If You Need Service

Keep your receipt, delivery slip, or some other appropriate payment record to establish the warranty period should service be required. If service is performed, it is in your best interest to obtain and keep all receipts. Service under this warranty must be obtained by contacting Electrolux at the addresses or phone numbers below.

This warranty only applies in the USA and Canada. In the USA, your appliance is warranted by Electrolux Major Appliances North America, a division of Electrolux Home Products, Inc. In Canada, your appliance is warranted by Electrolux Canada Corp. Electrolux authorizes no person to change or add to any obligations under this warranty. Obligations for service and parts under this warranty must be performed by Electrolux or an authorized service company. Product features or specifications as described or illustrated are subject to change without notice.

USA

1-800-374-4432

Frigidaire

10200 David Taylor Drive
Charlotte, NC 28262



Electrolux

Canada

1.800.265.8352

Electrolux Canada Corp.
5855 Terry Fox Way
Mississauga, Ontario, Canada
L5V 3E4



A06822904-R-142020