



OWNER'S MANUAL

Wi-Fi

SOUND BAR

Please read this manual carefully before operating your set and retain it for future reference.

Model

SP11RA (SP11RA, SPP8-W, SPP11-SL, SPP11-SR)

Sound Bar Quick Guide

| Installing and using the Product

1 Connect the sound bar to your TV via an optical cable or an HDMI cable.

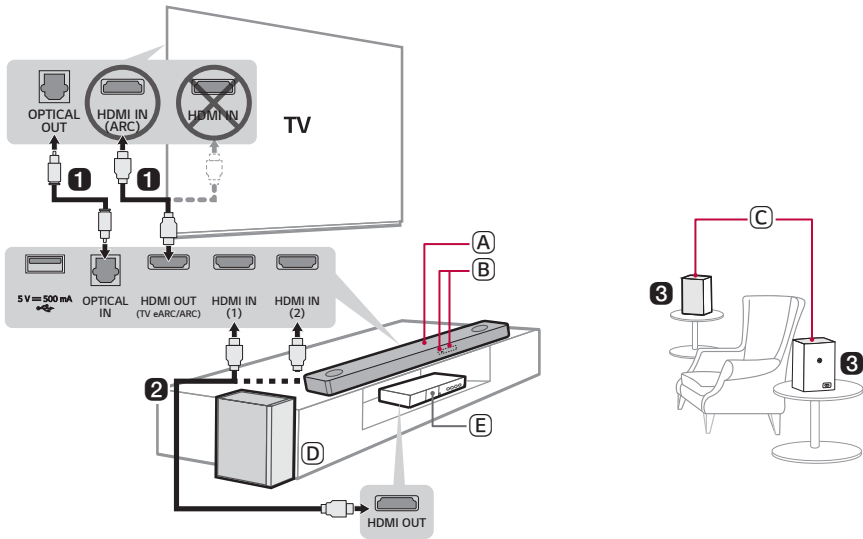

- (A) Sound bar
- (B) Remote Control Receiver / Status Display
- (C) Wireless Rear Speakers

- (D) Wireless Subwoofer - Install it close to the sound bar.
- (E) External Device - (Blu-ray player, game console, etc.)

- ② If you are using an external device (ex. Blu-ray player, game console, etc.), connect it to the sound bar via an HDMI cable.
- ③ Connect to power in the following order: wireless subwoofer → wireless rear speakers → sound bar. Then, turn on the sound bar. When the connection is automatically established with the sound bar, the LEDs on the wireless subwoofer and wireless rear speakers will light up in green. (→ See “Connecting the Product” on page 6.)

④ Using the product with your TV (→ See “Connecting to the TV” on page 29.)

- ① Press the **Function** (⏏) button repeatedly until “**OPT/HDMI ARC**” appears on the status display.
- ② On your TV's settings, set the output speaker to [HDMI ARC], [Optical], or [External Speaker].
- ③ When the TV is properly connected to the product, “**OPT**”, “**ARC**”, or “**E-ARC**” will appear on the status display with a sound.

⑤ Connecting the product to your smartphone via Wi-Fi (→ See “Connecting with a Smartphone via Wi-Fi” on page 15.)

- ① Connect your smartphone to Wi-Fi.
- ② Install the **LG Sound Bar app** on Google Play or the App Store.
- ③ Run the **LG Sound Bar app** and follow the instructions.
- ④ The product will connect to your smartphone and you can control the product with **LG Sound Bar app**.

⑥ Connecting the product to your smartphone via Bluetooth (→ See “Connecting via Bluetooth” on page 37.)

- ① Tap the **Settings** (⚙) button on your smartphone and select **Bluetooth**. Turn on the **Bluetooth** function. (Off > On)
- ② Press the **Bluetooth pair** (🔗) button. After a moment, you will see “**BT READY**” on the status display.
- ③ Find and tap “LG_Speaker_SP11RA_XXXX” or the name you registered on the Google Home app.
- ④ When the product is connected to your smartphone via **Bluetooth**, you can see the status display change from “**PAIRED**” → “**Connected Bluetooth device name**” → “**BT**”.

Manually connecting the sound bar to the wireless subwoofer or wireless rear speakers (→ See “Connecting the wireless subwoofer and wireless rear speakers manually” on page 8.)

If you see a red LED on the back of the wireless subwoofer or wireless rear speakers, it means that the sound bar is not connected to the speakers. If this is the case, connect them in the following order:



- ① Press the **Power**  button on the sound bar to turn it off.
- ② Press the **PAIRING (Pairing)** button on the back of the disconnected wireless subwoofer or wireless rear speakers. Check if each LED blinks green.
 - If you still see a red LED on the back of the wireless subwoofer or wireless rear speakers, press and hold the button on the back of the subwoofer or wireless rear speakers again.
- ③ Press the **Power**  button on the sound bar to turn it on.
- ④ When the connection is established, you will see a green LED light on the back of the wireless subwoofer or wireless rear speakers light up in green.

Table of Contents

Sound Bar Quick Guide

- 2 Installing and using the Product

Installation

- 6 Connecting the Product
- 15 Connecting with a Smartphone via Wi-Fi
- 18 Resetting the Product

Exploring the Product

- 19 Front
- 21 Back
- 22 Exploring Remote Control

Connecting to the TV

- 29 Connecting with an Optical Cable
- 31 Connecting with an HDMI Cable
- 33 Connecting via Bluetooth

Connecting to an External Device

- 34 Connecting with an HDMI Cable
- 36 Connecting with an Optical Cable

Using the Product as an Audio System

- 37 Connecting via Bluetooth
- 40 Connecting to a USB Storage Device
- 42 Using the LG Sound Bar app
- 43 Compatible with Google Assistant
- 44 Works with Apple AirPlay
- 45 Spotify Connect
- 46 Works with Alexa

Mounting the Product to a Wall

- 50 Mounting the Product to a Wall
- 52 Mounting the Wireless rear speakers to a Wall

Safety Precautions

- 53 Safety and Regulatory

Before Reporting Product Malfunction

- 56 Troubleshooting

Appendix

- 60 Specifications
- 62 Registered Trademarks and Licenses
- 63 What You Need to Know about Network Services
- 63 Open Source Software Notice Information
- 64 Handling the Product

Installation

Connecting the Product

You can enjoy a richer sound by connecting the sound bar to the wireless subwoofer and wireless rear speakers.

Connecting the wireless subwoofer and wireless rear speakers automatically

After completing installation, the wireless subwoofer and wireless rear speakers will automatically be connected to the sound bar. Connect the sound bar to the subwoofer and wireless rear speakers in the following order:

- 1** Plug the power cables into the wireless subwoofer and wireless rear speakers.
- 2** Plug the power cables connected to the wireless subwoofer and wireless rear speakers into an outlet.
- 3** Plug the sound bar power cable into an outlet.

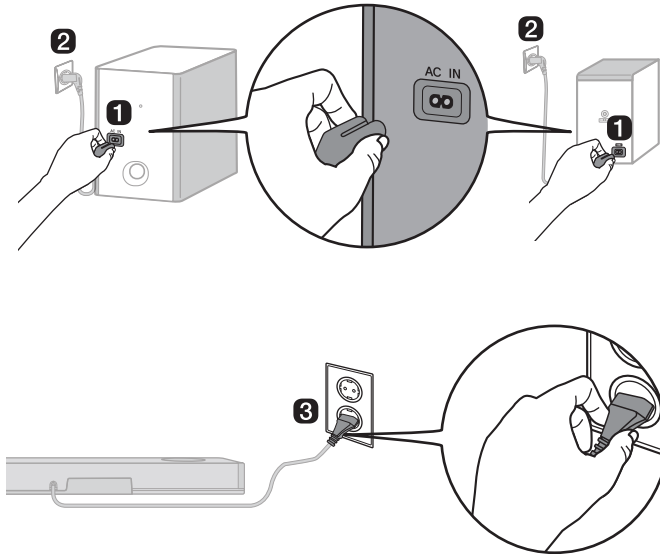

- 4** When the connection is automatically established, you will see the LEDs on the back of the wireless subwoofer and wireless rear speakers light up in green.

Checking the connection with the LEDs on the back of the wireless subwoofer and wireless rear speakers

You can check the connection status by looking at the LEDs on the back of the wireless subwoofer and wireless rear speakers.

| LED Color | Status |
|----------------|---|
| Blinking green | Connecting in progress |
| Green | Connected successfully |
| Red | Bad connection, or the subwoofer or wireless rear speakers are in standby |
| Off | Power cable not connected |

Connecting the wireless subwoofer and wireless rear speakers manually

If you see a red LED on the back of the wireless subwoofer or wireless rear speakers, it means that the sound bar is not connected to the subwoofer or wireless rear speakers. If this is the case, connect them in the following order:

- 1 Press the **Power** (⏻) button on the sound bar to turn it off.
- 2 Press the **PAIRING (Pairing)** button on the back of the wireless subwoofer or wireless rear speakers. Check if the LED on the back of the subwoofer or wireless rear speakers is blinking green. If you still see a red LED on the wireless subwoofer or wireless rear speakers, press and hold the button on the back of the subwoofer or wireless rear speakers again.

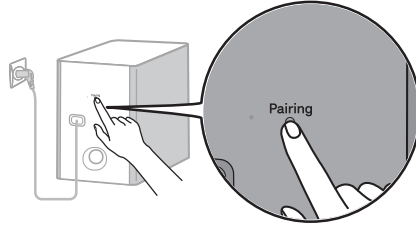

Connecting the wireless subwoofer manually

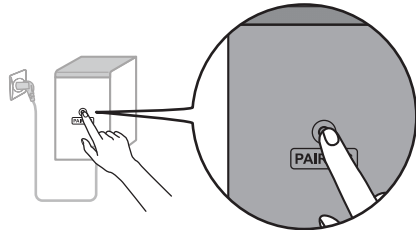

Connecting the wireless rear speakers manually

- 3 Press the **Power** (⏻) button on the sound bar to turn it on.
- 4 When the connection is established, you will see the LED light on the back of the wireless subwoofer or wireless rear speakers light up in green.

✔ **Note**

- Install the sound bar as close to the wireless subwoofer as possible. The closer the distance between the sound bar and the wireless subwoofer, the better the sound quality.
- Please ensure there are no obstacles between the sound bar and the wireless subwoofer.
- Keep the rear speakers at least 30 cm (11.8 inch) away from the TV or monitor.
- To prevent wireless interference, maintain a distance of at least 1 m (3.3 ft) between the sound bar or the wireless subwoofer, wireless rear speakers and any peripheral devices that generate strong electromagnetic waves (ex. wireless routers, microwave ovens, etc.).

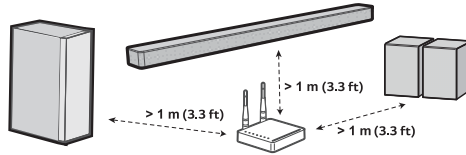

Setting up surround sound

The surround sound function allows you to hear immersive 3D sound produced by multiple audio channels from the speakers, regardless of the channels in the originally recorded content.

For example, if you listen to music recorded in 2.0 channels with standard sound effects while the wireless rear speakers are connected, you can hear the following difference.

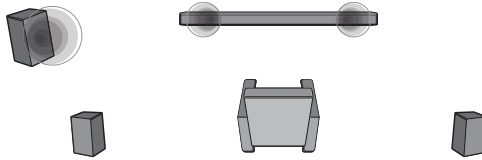

When the surround sound is off

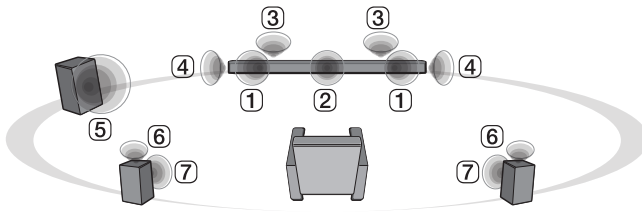

When the surround sound is on

✔ **Note**

- Speaker positions are as follows.

| | |
|---|-------------------|
| ① | Front speakers |
| ② | Center speaker |
| ③ | Top speakers |
| ④ | Side speakers |
| ⑤ | Subwoofer |
| ⑥ | Rear top speakers |
| ⑦ | Rear speakers |

Turning surround sound on/off

- 1 Press **Settings**  button. The product enters the setting mode and you can see “**OFF-AUTO POWER**” or “**ON-AUTO POWER**”.

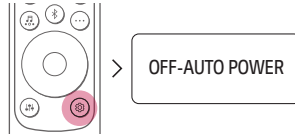

- 2 While the “**OFF-AUTO POWER**” or “**ON-AUTO POWER**” is scrolling in the status display, press **Left/Right** button to select the surround sound setting. You can see the status of the surround sound, “**OFF-SURROUND**” or “**ON-SURROUND**”.





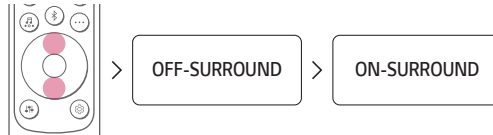









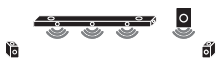

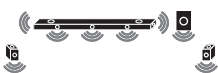

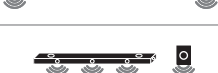



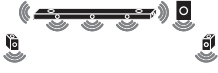







- 3 While the “**OFF-SURROUND**” or “**ON-SURROUND**” is scrolling in the status display, press **Up/Down** button to turn on or off the surround sound.

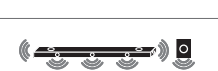

Speaker sound based on input channels

| Sound Effects | Input | | Output | |
|--|----------------------|-------|-----------------------------|-------------------------|
| | | | Rear speakers not connected | Rear speakers connected |
| AI SOUND PRO Sound customized with artificial intelligence | 2.0 channels | | | |
| | 5.1 channels | DTS | | |
| | | Other | | |
| | 7.1 channels or more | | | |
| STANDARD You can enjoy optimized sound. | 2.0 channels | | | |
| | 5.1 channels | DTS | | |
| | | Other | | |
| | 7.1 channels or more | | | |
| MUSIC Sound enriched with MERIDIAN technology | 2.0 channels | | | |
| | 5.1 channels | DTS | | |
| | | Other | | |
| | 7.1 channels or more | | | |

| Sound Effects | Input | | Output | |
|---|----------------------|-------|---|--|
| | | | Rear speakers not connected | Rear speakers connected |
| CINEMA Cinematic 3D sound | 2.0 channels | |  |  |
| | 5.1 channels | |  |  |
| | 7.1 channels or more | |  |  |
| CLEAR VOICE Voice sound clear, improving the quality of voice sound | 2.0 channels | |  |  |
| | 5.1 channels | DTS |  |  |
| | | Other |  |  |
| 7.1 channels or more | | |  |  |
| SPORTS Realistic sound like in a stadium | 2.0 channels | |  |  |
| | 5.1 channels | DTS |  |  |
| | | Other |  |  |
| 7.1 channels or more | | |  |  |
| GAME Optimized sound for game | 2.0 channels | |  |  |
| | 5.1 channels | DTS |  |  |
| | | Other |  |  |
| 7.1 channels or more | | |  |  |

| Sound Effects | Input | Output | |
|---|----------------------|-----------------------------|-------------------------|
| | | Rear speakers not connected | Rear speakers connected |
| BASS BLAST (BASS BLAST+) Sound with reinforced bass | 2.0 channels | | |
| | 5.1 channels | | |
| | 7.1 channels or more | | |

Connecting with a Smartphone via Wi-Fi

LG Sound Bar app allows you to connect the product to the network and to control the product.

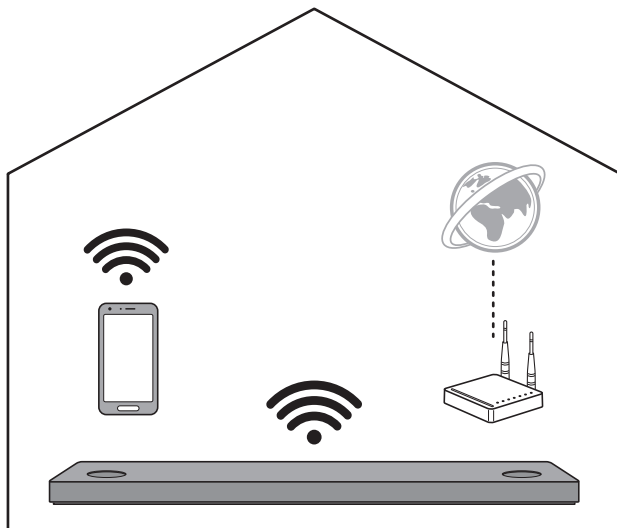

Please check the following first.

- Do you have a wireless router?
 - To connect your smartphone and the product via Wi-Fi, you must have a wireless router.
 - Make sure that they are both connected to the same Wi-Fi network.
- Does your smartphone have **Bluetooth** enabled?
 - Enable **Bluetooth** on your smartphone.
 - If **Bluetooth** is enabled, you can easily connect to Wi-Fi. If **Bluetooth** is disabled, the product may not be registered on the **LG Sound Bar app**.
- The **LG Sound Bar app** is available in the versions listed below.
 - Android™ OS: Version 5.0 or higher
 - iOS OS: Version 10 or higher

Installing the app

Install the **LG Sound Bar app** on your smartphone. To install the **LG Sound Bar app**, you can scan the QR code with a QR code scan app or download on Google Play or the App Store.

Downloading with a QR code

- 1 Scan the QR code below with a QR code scan app.
- 2 You will be directed to a page where you can download the **LG Sound Bar app**. Tap the app to install it.



(Android Phone OS)



(iPhone OS)

Downloading on Google Play or App Store

Go to the **Google Play** or the **App Store** on your smartphone and search for the **LG Sound Bar app** to install it.



Android™ Phone

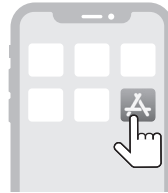

iPhone

✓ Note

- Settings menu items may vary depending on the smartphone manufacturer and OS.
- Google, Android, Google Play, Google Home and Chromecast built-in are trademarks of Google LLC.

Connecting with a Smartphone via LG Sound Bar app

You must connect the product to the smartphone via Wi-Fi on the **LG Sound Bar app** to use network services. The app installation method differs depending on the smartphone.

- 1 Find and tap the **LG Sound Bar app** installed on your smartphone.
- 2 Follow the instructions on the **LG Sound Bar app**. You will need to agree to the terms of service, Chromecast guide screen, and location permission settings. Turn on Wi-Fi and **Bluetooth**.
- 3 Select the product to connect. This product will be indicated as "LG_Speaker_SP11RA_XXXX".

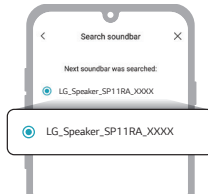

- 4 Select a Wi-Fi network and enter the password.

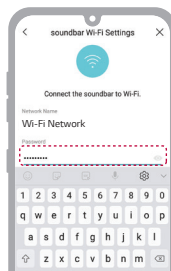

- 5 After completing product connection on the **LG Sound Bar app**, you will see "**CONNECTED**" appear on the status display on the product.

✓ **Note**

- You can register the product on Google Home app. For more information, please visit <http://www.google.com/cast/setup/>.
- You can create a speaker group with Google Home app and add up to 4 devices as a speaker group. Adding too many devices may become inconvenient when listening to music.
- If you want to check or change the registered home's nickname or the product name, connect to the Google Home app and tap the Device **Settings**  button.
- You cannot configure or control the product with the **LG ThinQ** app.

Resetting the Product

If the product is frozen and does not work, or if the network connection is unstable, you will need to reset it. If the Wi-Fi network has been changed, you will need to reset the product and connect it to your smartphone again.

How to reset

- 1 Press and hold the **Wi-Fi**  button on the top of the product until you hear a sound signal.
- 2 You will see "RESET" appear on the status display, and all wireless network settings on the product will be cleared.

-
- ✔ **Note**
- Once you reset the product, you will also need to reconnect the product to the smartphone via Wi-Fi on the **LG Sound Bar app**.

How to disconnect the wireless network connection or the wireless device

Press and hold the **Power**  button for 3 seconds or longer to turn off the product.

Exploring the Product

Front

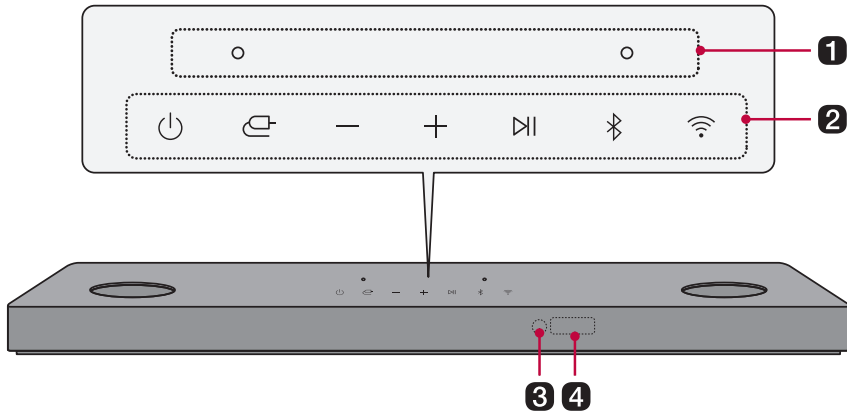



1 Built-in microphone

This uses when operating the AI room calibration on **LG Sound Bar app**.

2 Power

This turns the product on/off.

- If you press and hold the **Power**  button for longer than 3 seconds, Wi-Fi will disconnect and the product will no longer emit sound. Press the **Power**  button quickly to maintain the Wi-Fi connection for future use.

Function

Press the button repeatedly to select the desired function or input mode.

| Status Display | Description |
|----------------|---|
| WI-FI | Connects the product via Wi-Fi |
| BT | Connects the product via Bluetooth |
| OPT/HDMI ARC | Connects the product to a TV that supports an optical cable, ARC, E-ARC, or LG Sound Sync |
| HDMI1 | Connects the product to an HDMI IN (1) input port |
| HDMI2 | Connects the product to an HDMI IN (2) input port |
| USB | Connects the product to a USB storage device |

Volume

This adjusts the speaker volume with levels 0 to 40.

Play/Pause

This allows you to pause or play music.

Bluetooth pair

It allows you to pair your **Bluetooth** device such as a smartphone to this product for three minutes. (→ See “Connecting via **Bluetooth**” on page 37.)

Wi-Fi

It goes to the Wi-Fi function directly.

3 Remote Control Receiver

This receives wireless signals from the remote control.

4 Status display

Options such as input mode and volume are displayed in text.

- If there is no active input for 15 seconds, the status display will automatically dim. When you press the button, the status display will light up again.

✓ Note

- To reduce power consumption, the product will automatically turn off after 15 minutes of no input signal from an external device.

Back

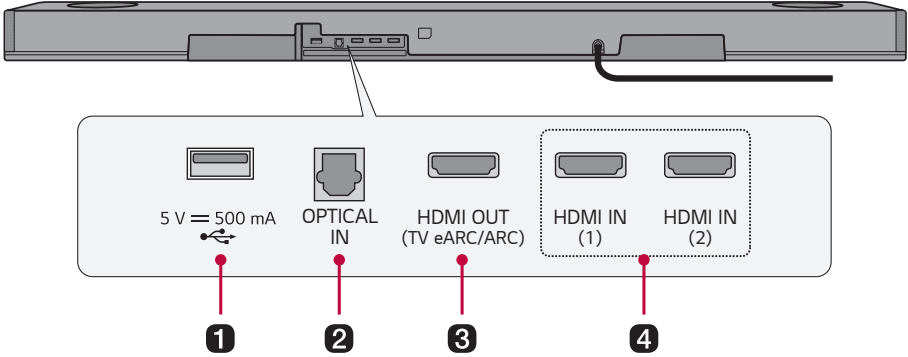

| | |
|----------------------------------|---|
| 1 USB port | Plug in a USB storage device to play music with the product. |
| 2 OPTICAL IN | Plug in an optical cable to connect the TV to the product. |
| 3 HDMI OUT (TV eARC/ARC) | Plug in an HDMI cable to connect the TV to the product. |
| 4 HDMI IN (1)/HDMI IN (2) | Plug in an HDMI cable to connect an external device to the product. |

Exploring Remote Control

You can use the remote to control all functions of the product, from turning the power on/off to enabling cinematic sound.

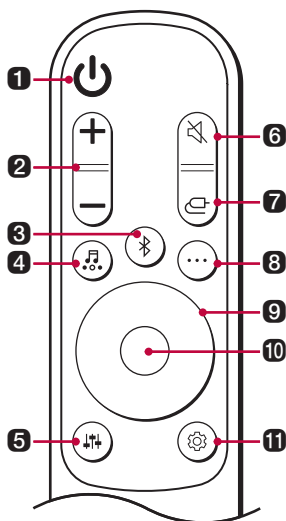

Replacement of Battery

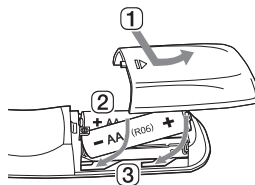

Use AA 1.5V batteries. Replace the two batteries by inserting them into the remote control in accordance with the directions indicated.

- 1 Open the battery cover on the back of the remote control.
- 2 Insert the batteries with the + and - ends corresponding to the markings.
- 3 Close the battery cover.

Risk of fire or explosion if the battery is replaced by an incorrect type.

1 Power

Turns the product on/off

2 Volume

Adjusts the sound volume

3 Bluetooth pair

It allows you to pair your **Bluetooth** device such as a smartphone to this product for three minutes. (→ See "Connecting via Bluetooth" on page 37.)

4 Sound Effects

Press the button to select the desired sound field.

| Status Display | Description |
|-----------------------------|---|
| AI SOUND PRO | Artificial intelligence selects the optimal sound settings to suit your content |
| STANDARD | You can enjoy optimized sound |
| MUSIC | Experience premium sound technology from MERIDIAN |
| CINEMA | Play content with 3D sound similar to a movie theater |
| CLEAR VOICE | Voice sound clear, improving the quality of voice sound |
| SPORTS | Realistic sound like in a stadium |
| GAME | Optimized sound for game |
| BASS BLAST (BASS BLAST+) | Bass sounds are enhanced |

- Sound effects cannot be changed when Dolby Atmos® or DTS:X® are enabled. Pressing the **Sound Effects**  button, will result in “**NOT SUPPORTED**” appearing on the status display.

5 Sound Tuning

This adjusts the sound level of the connected speaker. Press the **Sound Tuning**  button and then **Left/Right** button to select the desired speaker before you press the **Up/Down** button to increase/decrease the sound volume.

| Status Display | Connected Speaker | Adjustable Range |
|----------------|------------------------|------------------|
| WF | Subwoofer | -15 - 6 |
| C | Center speaker | -6 - 6 |
| OVC | Top speaker | -6 - 6 |
| S | Side speaker | -6 - 6 |
| R | Rear Speaker | -6 - 6 |
| ROV | Rear top speaker | -6 ~ 6 |
| TRE | Front speaker (treble) | -5 - 5 |
| BAS | Front speaker (bass) | -5 - 5 |

- Adjusting rear speakers level is applied only when the rear speakers are connected.

6 Mute

This turns off the sound from the product.

7 Function

Press the button repeatedly to select the desired input mode or function.

8 Information ⋮

View the connected Wi-Fi network or **Bluetooth** information.

| Input Mode/Function | Shown on Status Display |
|---------------------------|--|
| WI-FI | Connected app name |
| BT | Connected Bluetooth device name |
| OPT/ARC/E-ARC/HDMI1/HDMI2 | Current sound source |
| USB | Current sound filename |

9 Up/Down/Left/Right ⏮

These buttons are used to adjust the settings of the convenient functions.

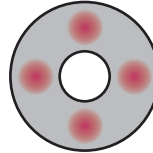

Up/Down: This scrolls through the folders on the USB storage device. You can press the button to select the desired folder.

Left/Right: If you play a previous song, press Left button. If you play a next song, press Right button..

10 Play/Pause ⏮

If you play or pause a song, press this button.

- When listening to music on a USB storage device, you can select the play mode by pressing the button for 3 seconds or longer, then press **Up/Down** to select the desired Repeat option.

| Status Display | Description |
|----------------|--|
| OFF | Plays the files in order, then ends playback |
| ONE | Plays the current file repeatedly |
| FOLDER | Only plays the files in the folder on a loop |
| ALL | Plays all files on a loop |
| SHUFFLE | Plays a random file until all files are played, then ends playback |

11 Settings

It allows you to adjust the settings of this product: AUTO POWER, SURROUND, NIGHT TIME, TV REMOTE. Press **Settings**  button and select the setting by using **Left/Right** button before you press the **Up/Down** button to turn on/off the setting.

- **AUTO POWER:** When the TV or an external device is turned on or off, the product will also turn on or off automatically. It is available only when the product is connected to the TV with an optical cable. (→ See "Using Auto Power" on page 27.)
 - **SURROUND:** The surround sound function allows you to hear immersive 3D sound produced by multiple audio channels from the speakers, regardless of the channels in the originally recorded content. (→ See "Turning surround sound on/off" on page 11.)
 - **NIGHT TIME:** This reduces the general sound volume, but raises the volume of soft and delicate sounds. This is useful when enjoying music or a movie late at night. (→ See "Using Night Time" on page 28.)
 - **TV REMOTE:** This convenient function allows you to adjust the volume of the product with your TV's remote control. (→ See "Controlling the product with your TV's remote control" on page 26.)
-

Controlling the product with your TV's remote control

The product volume can be adjusted with LG TV Remote control as well as other brands.

Functions controllable with a TV remote control

Volume, mute on/off

TV brands supported

LG, Panasonic, Philips, Samsung, Sharp Electronics, Sony, Toshiba, Vizio

Activating/Deactivating this function

- 1 Press **Settings** (⚙️) button. The product enters the setting mode and you can see "OFF-AUTO POWER" or "ON-AUTO POWER".

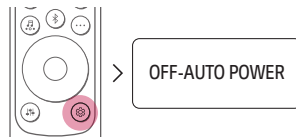

- 2 While the "OFF-AUTO POWER" or "ON-AUTO POWER" is scrolling in the status display, press **Left/Right** button to select the TV remote setting. You can see the status of the TV remote, "ON-TV REMOTE" or "OFF-TV REMOTE".



- 3 While the "ON-TV REMOTE" or "OFF-TV REMOTE" is scrolling in the status display, press **Up/Down** button to turn on or off the TV remote.



✔ **Note**

- Press the **Settings** button on the TV remote control to check if the TV's audio output is set to [External Speaker].
- You cannot control the product with the LG TV's Magic Remote Control.
- When the SIMPLINK or Sound Sync functions of the TV are turned on, this function may not work properly. Press the **Settings** button on the TV remote control to turn off this function.
- This function may not work well when the unit and the TV are connected with an HDMI cable.

Using Auto Power

This function automatically turns the product on or off when the TV or external device is turned on or off.

When the connected device is turned on, the product turns on automatically and selects a function according to the input signal.

Activating/Deactivating the Auto Power function

- 1 Press **Settings** button. The product enters the setting mode and you can see "OFF-AUTO POWER" or "ON-AUTO POWER".

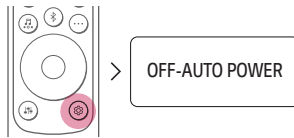

- 2 While the "OFF-AUTO POWER" or "ON-AUTO POWER" is scrolling in the status display, press **Up/Down** button to turn on or off the Auto Power function.

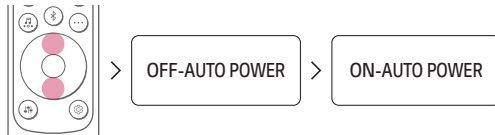

Using Night Time

This reduces the general sound volume, but raises the volume of soft and delicate sounds. This is useful when enjoying music or a movie late at night.

Activating/Deactivating the Night Time function

- 1 Press **Settings** (ⓘ) button. The product enters the setting mode and you can see “**OFF-AUTO POWER**” or “**ON-AUTO POWER**”.

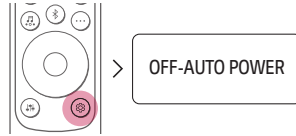

- 2 While the “**OFF-AUTO POWER**” or “**ON-AUTO POWER**” is scrolling in the status display, press **Left/Right** button to select the Night time setting. You can see the status of the Night time, “**ON-NIGHT TIME**” or “**OFF-NIGHT TIME**”.



- 3 While the “**ON-NIGHT TIME**” or “**OFF-NIGHT TIME**” is scrolling in the status display, press **Up/Down** button to turn on or off the Night time.



Connecting to the TV

Enjoy a rich, high-quality sound by connecting the product to a TV or a beam projector. It has been designed to enhance the realism of your favorite programming, such as dramas and sports broadcasts.

Connecting with an Optical Cable

Transmit your TV's audio to the product by connecting it to the TV with an optical cable. You can add a variety of 3D effects to the original audio to fill the room with a deep, rich sound.

Watching TV after connecting with an optical cable

- 1 If the digital cable terminal has a cover, first remove the covers from both ends.

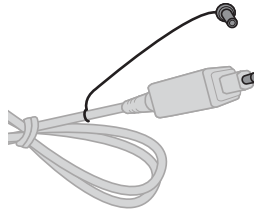

- 2 Using an optical cable, connect the **OPTICAL IN** terminal on the back of the product to the **Optical Digital Output (OPTICAL OUT)** terminal on the TV as shown in the picture.

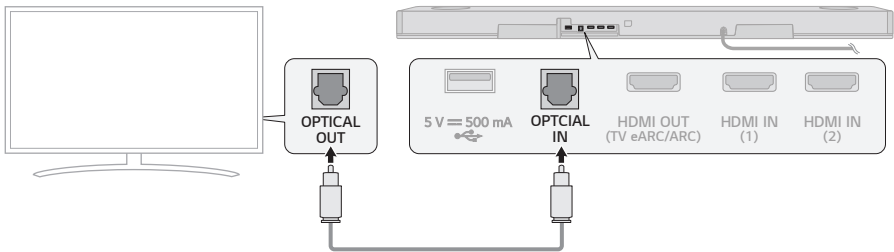

- 3 Press the **Function**  button repeatedly until “**OPT/HDMI ARC**” appears on the status display.

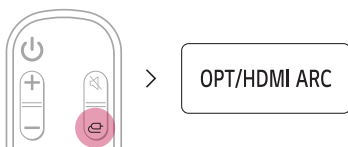

- 4 Press the **Settings** button on the TV remote control to enter the [Speaker] menu and set the output speaker to [Optical] or [External Speaker]. Settings and menu items may vary depending on the TV manufacturer.

- ✔ **Note**
- If the optical input signal and the ARC signal attempt to connect at the same time, the ARC signal will take priority.

When you use an LG TV

You can adjust the volume with the LG TV remote control if the TV is connected to the product with an optical cable. You can only do so on a TV that supports the LG TV Sound Sync function. Check your TV's user manual to see if your TV is supported.

Functions controllable with an LG TV remote control

Volume, mute on/off

- ✔ **Note**
- When the TV is properly connected to the product, “**LG OPT**” will appear on the status display.
 - When using the product with an LG TV remote control, the volume and mute status set on the TV will automatically be applied to the product.
 - You can still use the product's remote control even after connecting it to an LG TV.
 - To use LG Sound Sync, you may have to change the sound setting of your TV. It may vary depending on the TV.

Connecting with an HDMI Cable

You can transmit TV audio to the product by connecting the TV to the product with an HDMI cable. Add a variety of 3D effects to the original audio to fill the room with a deep, rich sound.

Watching TV after connecting with an HDMI cable

- 1 Using the HDMI cable, connect the **HDMI OUT (TV eARC/ARC)** terminal on the back of the product to the **HDMI IN (ARC)** terminal on the TV as shown in the picture.

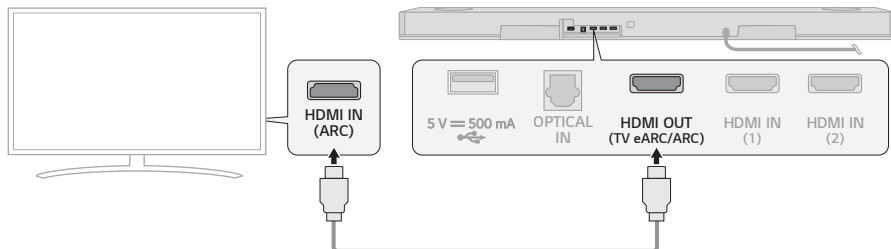

- 2 Press the **Function** (Ⓜ) button repeatedly until “**OPT/HDMI ARC**” appears on the status display.



- 3 Press the **Settings** button on the TV remote control to enter the [Speaker] menu and set the output speaker to [HDMI ARC]. Settings and menu items may vary depending on the TV manufacturer.
- 4 When the TV is properly connected to the product, “**ARC**” or “**E-ARC**” will appear on the status display.

✓ Note

- E-ARC supports high-quality audio such as DTS-HD Master Audio™, DTS:X®, Dolby TrueHD, and Dolby Atmos®.
- If you wish to use Dolby Atmos® or DTS:X®, the connected device and its content should support Dolby Atmos® or DTS:X®.
- Ensure that your TV supports the eARC function before you turn on eARC from the **Settings** menu. For more information on how to use this function, please refer to your TV's user manual. Settings may vary depending on the TV.
- Use a certified cable with the HDMI logo.

SIMPLINK

- SIMPLINK refers to the HDMI-CEC function that allows you to use a single TV remote control to easily operate an audio device or player connected to an LG TV via HDMI.
 - Functions controllable with a SIMPLINK-compatible LG TV remote control: Power on/off, volume control, mute on/off, etc.
- For more information on how to set up SIMPLINK, consult your LG TV's user manual.



✔ **Note**

- The SIMPLINK function may not work properly depending on the status of the product or other connected devices.
 - HDMI-CEC features by TV manufacturer: LG SIMPLINK, Sony BRAVIA Sync/Link, Philips EasyLink, Samsung Anynet+, etc.

Connecting via Bluetooth

Bluetooth is a technology that wirelessly connects electronic products around you. Connect the product to a TV via **Bluetooth** and enjoy your TV audio in high quality.

Watching TV after connecting it wirelessly

- 1 Press the **Bluetooth pair**  button. After a moment, "BT READY" appears on the status display.

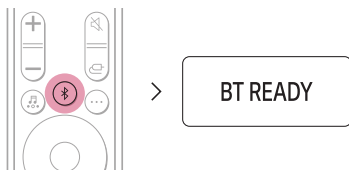

- 2 Press the **Settings** button on the TV remote control and enter the [Speaker] menu to set the output speaker to [**Bluetooth**].
- 3 Find and tap "LG_Speaker_SP11RA_XXXX" or the name you registered on the Google Home app.
- 4 When the product is connected to the TV via **Bluetooth**, you can see the status display change from "PAIRED" → "Connected TV name" → "BT".



- ✔ **Note**
- View or change the name of the product in the Settings menu on the first screen of the Google Home app. If you assigned the nickname "Living Room Cinema" in the Google Home app, it will be displayed on TV as "**Living Room Cinema**".
 - For **Bluetooth** devices, characters that cannot be displayed (ex. Korean Hangul) are shown as '?' on the product status display.
 - Press the **Information**  button on the remote control to check the name of the connected **Bluetooth** device. You will see the name of the connected **Bluetooth** device appear on the status display.

Connecting to an External Device

Experience movies and games in more realism by connecting the product to a device such as a game console or a Blu-ray player.

Connecting with an HDMI Cable

You can connect your TV or external device to the product with an HDMI cable for a deep, magnificent sound.

Connecting an external device via HDMI

- 1 Connect an external device such as a DVD or Blu-ray player. Following the picture below, connect the **HDMI OUT** terminal of the device to the **HDMI IN (1)** or **HDMI IN (2)** terminal on the back of the product.
- 2 Using the HDMI cable, connect the **HDMI OUT (TV eARC/ARC)** terminal on the back of the product to the **HDMI IN (ARC)** terminal on the TV.

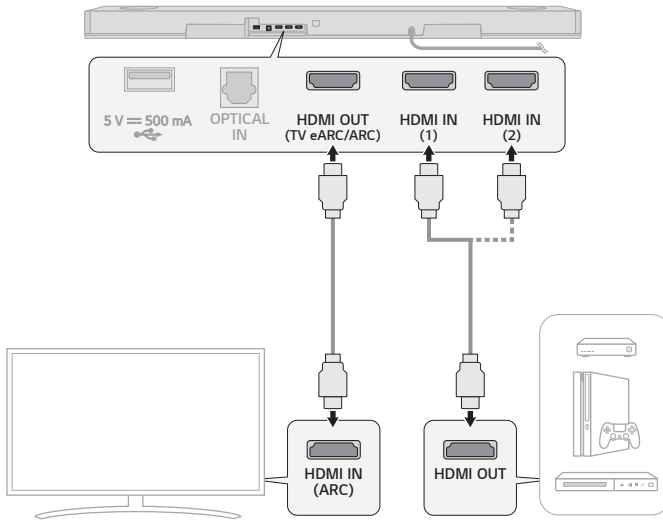

- 3 Press the **Function**  button repeatedly until **"HDMI1"** or **"HDMI2"** appears on the status display.



- 4 When the external device is properly connected to the product, you can listen to the sound of the device. When playing the video with Dolby Atmos® or DTS:X® technology, either **"DOLBY ATMOS"** or **"DTS:X"** will appear on the status display.

✓ **Note**

- Dolby Atmos® or DTS:X® audio supports 5.1.2 channels. When the wireless rear speakers are connected, 7.1.4 channels are supported.
- Please check the audio output settings in the Settings menu of your external device (ex. Blu-ray player or TV). The audio output should be set to [No encoding], [Bitstream], [Auto], or [Pass through]. For more information on how to set the output, please refer to your external device's user manual.
- Use a certified cable with the HDMI logo.

Connecting with an Optical Cable

You can connect a TV or external device to the product with an optical cable for a deep, magnificent sound.

Connecting an external device via optical cable

- 1 Use the optical cable to connect the **OPTICAL IN** terminal on the back of the product to the **OPTICAL OUT** terminal of your external device (ex. TV, Blu-ray player) as shown in the picture.

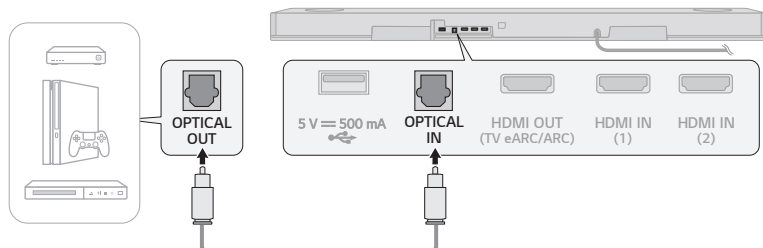

- 2 Press the **Function** button repeatedly until "OPT/HDMI ARC" appears on the status display.

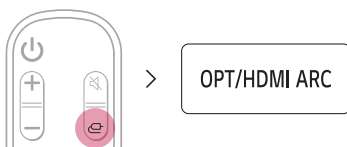

- 3 When the external device is properly connected to the product, "OPT" will appear on the status display.

Using the Product as an Audio System

Connecting via Bluetooth

You can play music files stored on a **Bluetooth** device, or run music apps to enjoy the music with this product.

Please check the following first.



- **Bluetooth** devices to be connected to the product should meet the following specifications.
 - Version: 5.0 or higher
 - Codec: SBC, AAC
- Steps to connect the device to the product may vary depending on the **Bluetooth** device type and model. For more information on how to connect the device, please refer to your external device's user manual.

Select the [**Bluetooth**] from your smartphone's **Settings** menu.

Settings menu items may vary depending on your smartphone manufacturer and model.

- 1 Turn on the product.
- 2 Press the **Bluetooth pair**  button. After a moment, "BT READY" appears on the status display.



- 3 Tap the **Settings**  /  button on your smartphone and select **Bluetooth** .

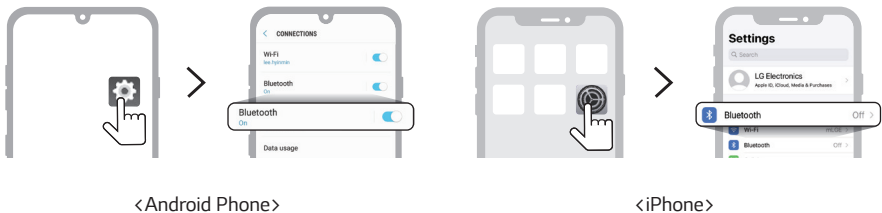

- 4 Turn on the **Bluetooth** function. ( Off >  On)

- 5 You will see a list of connectable devices on your smartphone. Find and tap "LG_Speaker_SP11RA_XXXX" or the name you registered on the Google Home app.



- 6 When the product is connected to the smartphone via **Bluetooth**, you will see the status display change from "PAIRED" → "Connected Bluetooth device name" → "BT".



- 7 If you cannot find the product "LG_Speaker_SP11RA_XXXX", tap the **Refresh** button at the top right of the screen on the Android smartphone or turn the **Bluetooth** off and turn it on again on iPhone.

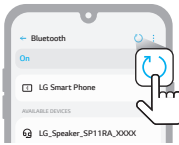

<Android Phone>

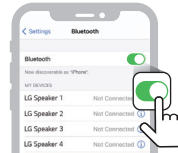

<iPhone>

- 8 Run a Music app and listen to music on the smartphone.



✔ **Note**

- The closer the **Bluetooth** device is to the product, the better your connection.
- If you pressed the **Bluetooth pair**  button of the product and selected the “**BT**” option, but could not connect to the **Bluetooth** device, you will see “**BT READY**” on the status display. Check the status of the **Bluetooth** device.
- When using **Bluetooth**, you should adjust the volume level to an appropriate level.
- In the **Bluetooth** name of this product “LG_Speaker_SP11RA_XXXX”, “XXXX” is randomly generated four-digit numbers and alphabets.

Connecting to a USB Storage Device

Enjoy high-quality sound by connecting a USB storage device containing music files to the product.

Connecting the product to a USB storage device

- 1 Plug the USB storage device into the **USB** port on the back of the product.
 - The product cannot play any devices connected via a USB storage device hub or a USB storage device cable.
 - The product cannot be connected to any USB storage device, USB type MP3 player, or card reader that requires a separate device drive to be installed.

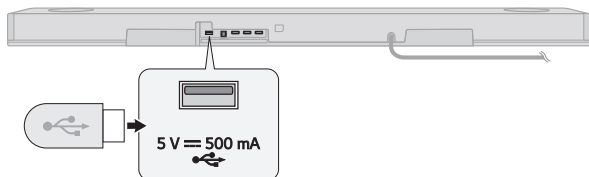

- 2 Press the **Function** (Ⓜ) button repeatedly until "USB" appears on the status display.

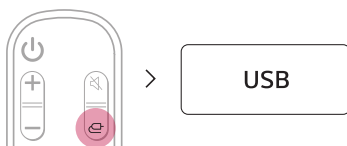

- 3 When the product is properly connected to a USB storage device, the number of music files in the USB device will appear on the status display. Press the **Play/Pause** (⏮) button on the remote control to enjoy the music.

- ✔ **Note**
- It is recommended that you purchase a separate USB gender changer to make it easier to plug in and out USB storage devices.
 - Purchase a USB gender changer with a USB 2.0 extension cable.
 - USB devices with a large storage volume may take several minutes to browse through files.
 - LG Electronics is not responsible for any data loss. Please always back up the data on your USB storage device to minimize damage caused by data loss.
 - Only FAT16/FAT32/NTFS formats are supported. exFAT format is not supported.

USB storage devices supported

| | |
|------------------|-------------------|
| MP3 player | Flash MP3 player |
| USB flash device | USB 2.0 or higher |

This product may not recognize some USB storage devices.

Playable file specifications

| File extension | Sampling frequency | Bitrate |
|----------------|--------------------|--------------------|
| MP3 | 32 kHz - 48 kHz | 8 kbps - 320 kbps |
| AAC | 32 kHz - 48 kHz | 8 kbps - 320 kbps |
| OGG | 32 kHz - 48 kHz | 64 kbps - 320 kbps |

| File extension | Sampling frequency |
|----------------------|--|
| FLAC (16 bit/24 bit) | 32 kHz, 44.1 kHz, 48 kHz, 88.2 kHz, 96 kHz, 176.4 kHz, 192 kHz |
| WAV (16 bit/24 bit) | 32 kHz, 44.1 kHz, 48 kHz, 88.2 kHz, 96 kHz, 176.4 kHz, 192 kHz |

- Number of playable files: Up to 2,000
- Maximum number of directories: Up to 200
- This product cannot play files protected by DRM (Digital Rights Management).
- This product cannot play video files from a USB storage device.

Using the LG Sound Bar app

Controlling device functions

Run the **LG Sound Bar app** and tap the **Settings** (⚙️) button on the first screen.

You can easily set [Sound Effect] and [Night Time] and adjust the level of each speaker without a remote control.



Using AI Room Calibration

This technology allows you to analyze the sound coming from the product and fine-tune the audio settings. Tap the **Settings** (⚙️) button on the first screen of the **LG Sound Bar app** and tap the [AI Room Calibration] from the list. Please note that, when you start AI Room Calibration, the product may make a louder sound than expected.



Using Chromecast built-in™

You can listen to your favorite music on this product using hundreds of Chromecast-enabled apps on your phone, tablet or laptop.



Simply tap the **Cast** button from apps you already know and love. No new logins or downloads required. Use your phone to search, play, pause and turn up the volume from anywhere in the home.

For more information on Chromecast built-in, including a list of Chromecast-enabled apps you can cast from, visit g.co/cast/audio

To set up multiroom with other Chromecast-enabled speakers, download the **Google Home** app.

Compatible with Google Assistant

This unit can be controlled using just your voice with Google.

If you have a Google Assistant-enabled speaker, simply add this device in your Google Home app. You will be able to play, skip, or stop music, and change the volume - just ask Google.

Requirements

- Google Assistant-enabled device (Sold Separately)
- This product must be connected to Internet.
- This product must be registered in the **Google Home** app.



Works with Apple AirPlay

This product allow you to listen to the music from your iOS device through AirPlay.

- ✔ **Note**
 - Make sure that this product and your iOS device are connected to the same Wi-Fi network.
 - Make sure that your iOS device is running iOS 11.4 or later.
 - The AirPlay 2-Enabled Speakers are needed to stream to multiple speakers.

Wi-Fi network setting with iOS device

- 1 Turn on the product by pressing the **Power** (⏻) button.
- 2 On your iOS device, select the **Settings** and then **Wi-Fi**.
- 3 Select “LG_Speaker_SP11RA” on the **SET UP NEW AIRPLAY SPEAKER**.
- 4 Make sure your home router is selected.
In this step, you can change the speaker's name of your choice and also you can set up a password. After completing the settings, select the **Next**.
- 5 Select **Done**.

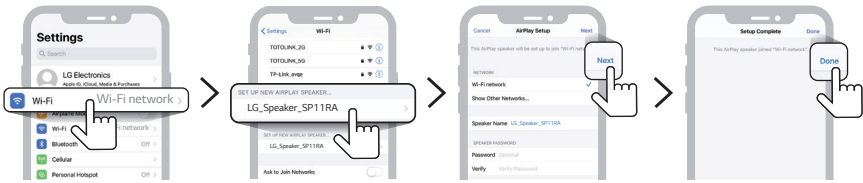

Stream music through AirPlay

From the Control Center:

- 1 Open the Control Center on your iOS device.
- 2 Tap AirPlay (📶).
- 3 Choose your product to listen to music. You can choose one or more AirPlay 2 -enabled speakers.

From a music player app:

- 1 Open a music player app.
- 2 Tap AirPlay (📶).
- 3 Choose your product to listen to music. You can choose one or more AirPlay 2 -enabled speakers.



Apple®, AirPlay®, iPad®, iPad Air®, iPad Pro® and iPhone® are trademarks of Apple Inc., registered in the U.S. and other countries.

Use of the Works with Apple badge means that an accessory has been designed to work specifically with the technology identified in the badge and has been certified by the developer to meet Apple performance standards.

To control this AirPlay 2-enabled speaker, iOS 11.4 or later is required.

| Spotify Connect

Use your phone, tablet or computer as a remote control for Spotify. Go to spotify.com/connect to learn how.



The Spotify Software is subject to third party licenses found here: <https://www.spotify.com/connect/third-party-licenses>.

Works with Alexa

Alexa lets you use your voice to control this product by speaking commands through an Alexa Built-in device. Alexa Built-in device is sold Separately.

Alexa setup flow

- 1 Run the **LG Sound Bar app** and tap **amazon alexa** button on the first screen and then follow the instructions.

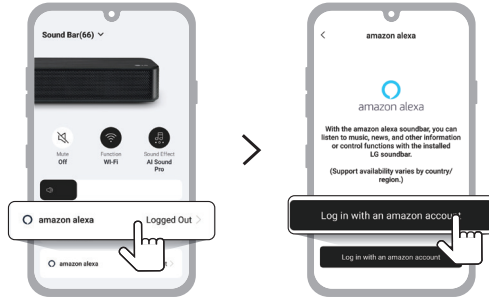

- 2 Sign in to amazon.

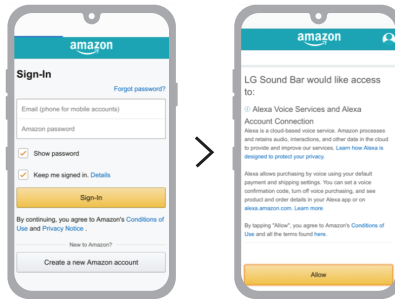

How to use Alexa

- **Explicating targeting:** Through Alexa Built-in devices (e.g. Amazon Echo), you can ask Alexa to play music on your [LG SP11 Soundbar]. For example, "Alexa, play jazz on [LG SP11 Soundbar]".
- **Preferred Speaker:** You can set one or more speakers so specific devices within a Smart Home Group plays music. You can set a speakers using the Alexa app.
- **Multi-Room Music group:** You can play music in different rooms or enjoy whole home audio with the same song across your compatible devices. To do this, you can use the Alexa app to create a Multi-Room Music group.
- **Music casting from Alexa app:** You can control music playback to your [LG SP11 Soundbar] remotely from the Alexa app.

Amazon, Alexa and all related logos are trademarks of Amazon.com, Inc. or its affiliates.

✔ Note

- This service is provided by Amazon and can be terminated at any time. LG does not assume responsibility for service availability.
- Amazon Alexa app screen is subject to change without prior notice.
- This feature may not be available in some countries.
- For more information, visit the web site
 - <https://www.amazon.com/gp/help/customer/display.html?nodeId=202207000>

Mounting the Product to a Wall

You can mount this product and wireless rear speakers onto a wall.

When affixing the product and wireless rear speakers to the wall, follow the instructions below.

Please check the following first.

- It may be difficult to connect external devices and cables after wall-mounting. First, connect an external device with the proper connection cable to the product before mounting it to the wall.
- Please note the following when you mount the product to the wall. Product damage or injury may occur during the process.
 - Do not put objects on top of the wall-mounted product.
 - Secure the product firmly to the wall using the fixing screws so that it does not fall off.
 - Ensure it is out of the reach of children. Pulling or shaking the mounted product may cause it to fall.
- There are also speakers on the top of the product. When installing the product under the TV, install it 10 cm (3.9 inch) away from the bottom of the TV.

Components for mounting the product

Sound bar

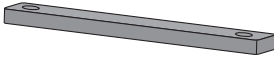

Wall bracket

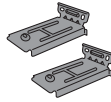

Sound bar screws



Wall bracket installation guide

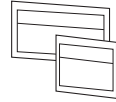

Components for mounting the wireless rear speakers

Wireless rear speakers

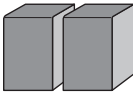

Wall bracket

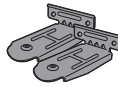

Wireless rear speakers screws



Sold separately

Bracket screws



Wall plugs

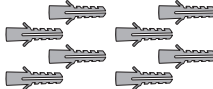

✔ Note

- Screws and Wall Plugs are not supplied for mounting the product. We recommend the Hilti (HUD-1 6 x 30) for the mounting.

Mounting the Product to a Wall

- 1 Find the wall bracket installation guide in the product package. Attach the two wall bracket installation guides to connect them into one.
- 2 Align the **"TV Bottom Line"** on the wall bracket installation guide with the bottom of the TV, and attach it to the wall.
Align the center of the wall-mounted TV with the part marked **"TV Center"** in the installation guide.

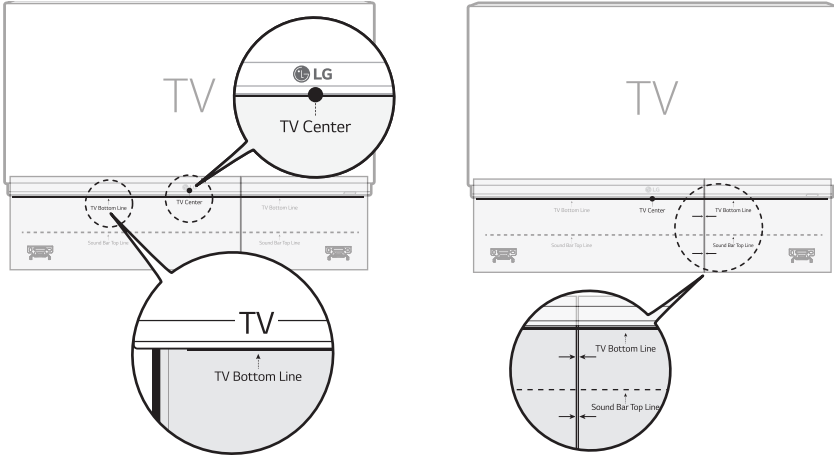

- 3 With a pen, mark screw holes on the installation guide where the wall brackets will be attached.

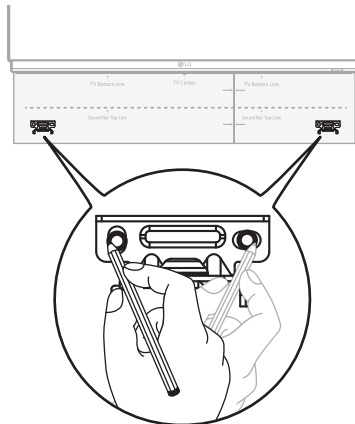

- 4 Drill screw holes in the marked positions on the installation guide.
- 5 Remove the wall bracket installation guide from the wall.

- 6** Fix the brackets firmly to the wall using the wall plugs and screws.

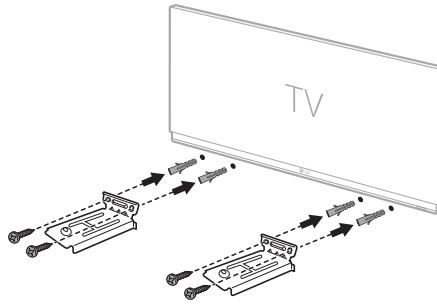

- 7** Place the product on the brackets. Position the product on the brackets so the screw holes on the bottom of the product align with the screw holes on the wall bracket.

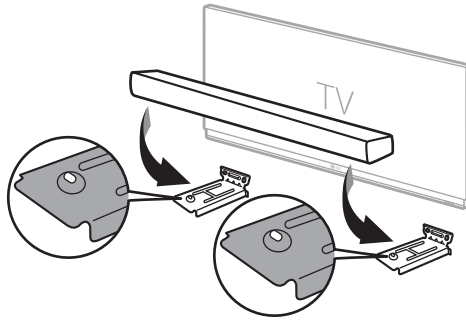

- 8** Firmly affix the product to the wall brackets using the screws provided.

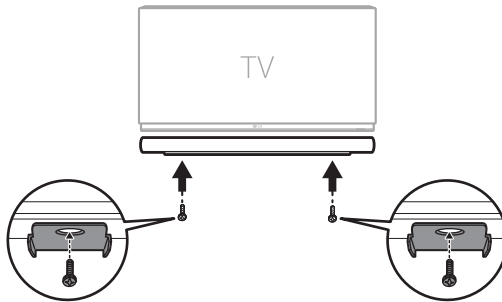

Mounting the Wireless rear speakers to a Wall

- 1 Check the position where you want to install the wireless rear speakers.
- 2 Fix the brackets firmly to the wall using the wall plugs and screws.

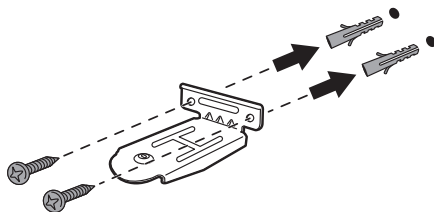

- 3 Put the wireless rear speakers on the brackets. Put the speakers on the brackets so that the screw holes on the bottom of the speakers align with the screw holes on the wall brackets.

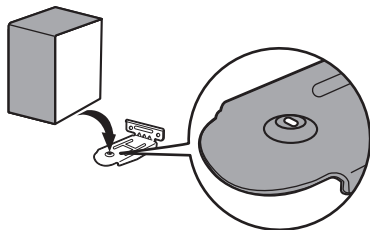

- 4 Fix the wireless rear speakers firmly to the wall brackets using the fixing screws.

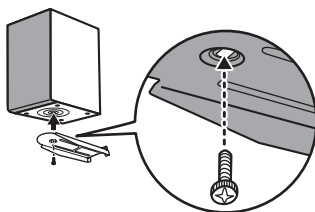

Safety Precautions

| Safety and Regulatory



CAUTION: TO REDUCE THE RISK OF ELECTRIC SHOCK DO NOT REMOVE COVER (OR BACK) NO USER-SERVICEABLE PARTS INSIDE REFER SERVICING TO QUALIFIED SERVICE PERSONNEL.



This lightning flash with arrowhead symbol within an equilateral triangle is intended to alert the user to the presence of uninsulated dangerous voltage within the product's enclosure that may be of sufficient magnitude to constitute a risk of electric shock to persons.



The exclamation point within an equilateral triangle is intended to alert the user to the presence of important operating and maintenance (servicing) instructions in the literature accompanying the product.

WARNING:

- TO PREVENT FIRE OR ELECTRIC SHOCK HAZARD, DO NOT EXPOSE THIS PRODUCT TO RAIN OR MOISTURE.
- Do not install this equipment in a confined space such as a book case or similar unit.

CAUTION:

- Do not use high voltage products around this product. (ex. Electrical swatter) This product may malfunction due to electrical shock.
- No naked flame sources, such as lighted candles, should be placed on the apparatus.
- Do not block any ventilation openings. Install in accordance with the manufacturer's instructions. Slots and openings in the cabinet are provided for ventilation and to ensure reliable operation of the product and to protect it from over heating. The openings should never be blocked by placing the product on a bed, sofa, rug or other similar surface. This product shall not be placed in a built-in installation such as a bookcase or rack unless proper ventilation is provided or the manufacturer's instruction has been adhered to.
- The apparatus should not be exposed to water (dripping or splashing) and no objects filled with liquids, such as vases, should be placed on the apparatus.
- For safety marking information including product identification and supply ratings, please refer to the main label on the bottom or the other surface of the product.
- Be careful to make sure children do not put their hands or any objects into the *speaker duct.
 - * speaker duct: A hole for plentiful bass sound on speaker cabinet. (enclosure)

CAUTION concerning the Power Cord

The Power Plug is the disconnecting device. In case of an emergency, the Power Plug must remain readily accessible.

Check the specification page of this owner's manual to be certain of the current requirements.

Do not overload wall outlets. Overloaded wall outlets, loose or damaged wall outlets, extension cords, frayed power cords, or damaged or cracked wire insulation are dangerous. Any of these conditions could result in electric shock or fire. Periodically examine the cord of your device, and if its appearance indicates damage or deterioration, unplug it, discontinue use of the device, and have the cord replaced with an exact replacement part by an authorized service center.

Protect the power cord from physical or mechanical abuse, such as being twisted, kinked, pinched, closed in a door, or walked upon. Pay particular attention to plugs, wall outlets, and the point where the cord exits the device.

For models using an adapter

Only use the AC adapter supplied with this device. Do not use a power supply from another device or another manufacturer. Using any other power cable or power supply may cause damage to the device and void your warranty.

For models using a Laser device



This product employs a Laser System. To ensure proper use of this product, please read this owner's manual carefully and retain it for future reference. Shall the unit require maintenance, contact an authorized service center. Use of controls, adjustments or the performance of procedures other than those specified herein may result in hazardous radiation exposure. To prevent direct exposure to laser beam, do not try to open the enclosure.

For models using a battery







This device is equipped with a portable battery or accumulator.

CAUTION: Risk of fire or explosion if the battery is replaced by an incorrect type.

For models using a built-in battery

Do not store or transport at pressures lower than 11.6 kPa (0.116 bar) and at above 15,000 m (9.32 miles) altitude.

- replacement of a battery with an incorrect type that can defeat a safeguard (for example, in the case of some lithium battery types);
- disposal of a battery into fire or a hot oven, or mechanically crushing or cutting of a battery, that can result in an explosion;
- leaving a battery in an extremely high temperature surrounding environment that can result in an explosion or the leakage of flammable liquid or gas; and
- a battery subjected to extremely low air pressure that may result in an explosion or the leakage of flammable liquid or gas.





| Symbols | | | |
|---|-------------------------------|---|-------------------------|
|  | Alternating current (AC). |  | Standby power state. |
|  | Direct current (DC). |  | The power is turned on. |
|  | This is a class II equipment. |  | Danger voltage. |

Before Reporting Product Malfunction



Troubleshooting

If you experience the following issues while using the product, please perform several checks, as they may not be malfunctions.

General Errors

| Issue | Solution |
|---|--|
| The product does not work properly | <ul style="list-style-type: none">• Unplug the power cables and any external devices such as your TV, subwoofer, or amplifier from the product, then plug them in again.• After resetting the product, connect your smartphone and Wi-Fi again. (→ See "Connecting with a Smartphone via Wi-Fi" on page 15.)• Please beware that previous product settings may be lost. |
| The power does not turn on | <ul style="list-style-type: none">• Is the power cord plugged into the outlet properly?<ul style="list-style-type: none">- Connect the power plug to the outlet correctly. |
| There is no sound | <ul style="list-style-type: none">• Is the volume set to minimum?<ul style="list-style-type: none">- Press the Volume   button on the remote control to turn up the volume.- If you are using an external device such as a set-top box, portable device, or Bluetooth device, adjust the volume of the external device.• Is the mute function activated?<ul style="list-style-type: none">- If "MUTE" appears on the status display, the mute function is on. Press the Mute  button to unmute.• Is the correct product function selected according to the external device connected?<ul style="list-style-type: none">- Press the Function  button to check if you selected the correct function. |
| The subwoofer does not produce sound | <ul style="list-style-type: none">• Is the product properly connected to the wireless subwoofer?<ul style="list-style-type: none">- If the LED on the back of the wireless subwoofer is blinking green or lit in red, it means it is not connected. If the connection is established, a green light will appear. Reconnect the product to the wireless subwoofer. (→ See "Connecting the Product" on page 6.) |
| The remote control does not work properly | <ul style="list-style-type: none">• When using the remote control, point it at the front of the product.• Use the remote control within a 7-m (23 ft) radius of the product.• Replace the batteries with new ones as needed. |
| The Auto Power function does not work | <ul style="list-style-type: none">• Check connection to external devices (ex. set-top box, portable device, Bluetooth device). |
| LG Sound Sync does not work | <ul style="list-style-type: none">• Check whether your TV supports LG Sound Sync.• Check if the TV is properly connected to the product via an optical cable.<ul style="list-style-type: none">- Press the Settings button on the TV remote control to check if the function is turned on in [LG Sound Sync]. |

The product volume is low

- Check the following and change the settings accordingly.
 - Run the **LG Sound Bar app**, tap the **Settings**  button on the first screen, and change the [DRC] function to [Off] on the [Sound Settings] menu.
 - When the product is connected to a TV, press the **Settings** button on the TV remote control, select the [Speaker] menu, and change the [Digital Sound Output] setting from [PCM] to [AUTO] or [BITSTREAM].
 - If the product is connected to a playback device such as a DVD player or Blu-ray disc player, go to the connected device's Settings menu. Change the [Digital Sound Output] setting from [PCM] to [PRIMARY PASS-THROUGH] or [BITSTREAM]. Set the [DRC] of the connected device to [OFF].
 - If the product's Night Time mode is on, turn it off by pressing the **Settings**  button and **Left/Right** and then **Up/Down**.

The product fails to recognize a USB storage device

- The product may not support the file format of the USB storage device. Format the USB storage device and reconnect it. When formatting, refer to the USB storage device formats supported by the product and select an appropriate file format. (→ See "Connecting to a USB Storage Device" on page 40.)

A Bluetooth device cannot be paired

- Press the Settings button on the **Bluetooth** device and check whether the **Bluetooth** function is enabled. If **Bluetooth** is enabled, turn it off and on, then try again.
 - Remove any obstacles between the product and the **Bluetooth** device.
 - **Bluetooth** pairing (connection) may not work properly depending on the **Bluetooth** device type or the surrounding environment.
-

Network Connection Errors

| Issue | Solution |
|---|---|
| The product cannot be connected to the LG Sound Bar app | <ul style="list-style-type: none">• The connection may not be smooth when disturbed by other electric appliances that use radio waves, such as microwave ovens and medical equipment. Install the product 1 m (3.3 ft) away from other home appliances.• Turn off your wireless router and turn it on again.• Check if your smartphone's Wi-Fi function is turned on. You can check the Wi-Fi connection status in your smartphone's settings.• Check if the product and smartphone are on the same Wi-Fi network. |
| The product does not connect to the Wi-Fi network | <ul style="list-style-type: none">• Did you turn off the wireless router and turn it on again?<ul style="list-style-type: none">- Turn off the product and then turn it on again.• Have you installed a new wireless router?<ul style="list-style-type: none">- You will need to reconfigure the network settings of the product. (→ See "Connecting with a Smartphone via Wi-Fi" on page 15.) |





App Errors

| Issue | Solution |
|---------------------------------|---|
| The app is not working properly | <ul style="list-style-type: none">• Do you get an error when running the app?<ul style="list-style-type: none">- Check if the power of the device is turned on.- Check if the app you wish to run supports the operating system of your smartphone. You can visit the app manufacturer's website to confirm supported operating systems.- Check if you have the latest version of the app. Search for the app on Google Play or the App Store and check if an Update button appears next to it. If it is not the latest version, tap the Update button. |

Problems in Wireless Connection

| Issue | Solution |
|---|---|
| There is radio interference | <ul style="list-style-type: none">• Install the product and the wireless subwoofer as close to each other as possible.• Do not install the product on metal furniture.• Wireless communication may not work properly in weak signal areas. |
| The Bluetooth connection is causing a malfunction or making noise | <ul style="list-style-type: none">• Do you hear noise or experience malfunctions when using Bluetooth?<ul style="list-style-type: none">- Do not let any part of your body contact the transceiver of the Bluetooth device or the product.- Do not install the Bluetooth device on a wall or in a secluded spot.- Remove any obstacles between the product and the Bluetooth device.- Install the Bluetooth device near the product.• When the Bluetooth device is too far from the product, Bluetooth may be disconnected or malfunctions may occur.<ul style="list-style-type: none">- Install the Bluetooth device 1 m away from devices that use the same frequency as the product, such as wireless routers, medical equipment, and microwave ovens. |

Turning off the Demo Mode

| Issue | Solution |
|----------------------------------|---|
| The remote control does not work | <ul style="list-style-type: none">• Does the text on the status display remain unchanged, even if you press the Function  button several times?• Do you only see the text "DEMO" in the status display?<ul style="list-style-type: none">- The demo mode may be activated on the product. Unplug the product's power cable and plug it back in.- If the remote control still does not work, press the Volume   button on the product to set the volume level at 2, then press and hold the Function  button for about 5 seconds. If the currently selected function appears on the status display, it means that demo mode has been turned off. |

Appendix

Specifications

| General | |
|--|--|
| Power Requirement | Refer to the main label. |
| Power Consumption | Refer to the main label. |
| Dimensions (W x H x D) | Approx. 1443.0 mm x 63.0 mm x 146.0 mm (including the base) (56.8 inch x 2.5 inch x 5.7 inch) |
| Operation Temperature Range | 5 °C - 40 °C (41 °F to 104 °F) |
| Operation Humidity Range | 5 % - 60 % |
| Bus Power Supply (USB) | 5 V  500 mA |
| Available Digital Input Audio Sampling Frequency | 32 kHz, 44.1 kHz, 48 kHz, 88.2 kHz, 96 kHz, 176.4 kHz, 192 kHz |
| Available Digital Input Audio format | Dolby Atmos®, Dolby Audio™, DTS:X®, DTS-HD, PCM |

| Input/Output | |
|---------------------------|--|
| OPTICAL IN | 3.0 V (p-p), (optical audio connection terminal) × 1 |
| HDMI IN (1) / HDMI IN (2) | 19-pin (Type A, HDMI™ connection terminal) × 2 |
| HDMI OUT (TV eARC/ARC) | 19-pin (Type A, HDMI™ connection terminal) × 1 4K resolution is supported for 4K sources applied with HDCP 2.3. |

| Amplifier (RMS output) | |
|------------------------|---------------------------------------|
| Total | 770 W RMS |
| Front | 50 W RMS×2 (Impedance: 4 Ω, THD 10 %) |
| Center | 50 W RMS (Impedance: 4 Ω, THD 10 %) |
| Sides | 50 W RMS×2 (Impedance: 4 Ω, THD 10 %) |
| Top | 50 W RMS×2 (Impedance: 4 Ω, THD 10 %) |
| Rear | 50 W RMS×2 (Impedance: 3 Ω, THD 10 %) |
| Rear Top | 50 W RMS×2 (Impedance: 3 Ω, THD 10 %) |
| Subwoofer | 220 W RMS (Impedance: 3 Ω, THD 10 %) |

| Wireless Subwoofer | |
|---------------------------|--|
| Power Requirement | Refer to the main label on the Wireless Subwoofer. |
| Power Consumption | Refer to the main label on the Wireless Subwoofer. |
| Type | 1-way 1 speaker |
| Impedance | 3 Ω |
| Rated power | 220 W RMS |
| Max. Power | 440 W RMS |
| Dimensions (W x H x D) | Approx. 221.0 mm x 390.0 mm x 312.8 mm (8.7 inch x 15.4 inch x 12.3 inch) |

| System | |
|---------------------------------|--|
| Wireless LAN (Internet antenna) | 802.11a/b/g/n Wi-Fi network compatible |

| Wireless Rear speakers (Each) | | |
|--------------------------------------|--|-----------------|
| Power Requirement | Refer to the main label on the wireless rear speakers. | |
| Power Consumption | Refer to the main label on the wireless rear speakers. | |
| Type | Rear Speaker | 1-way 1 speaker |
| | Rear Top Speaker | 1-way 1 speaker |
| Impedance | Rear Speaker | 3 Ω |
| | Rear Top Speaker | 3 Ω |
| Rated Input Power | Rear Speaker | 50 W RMS |
| | Rear Top Speaker | 50 W RMS |
| Max. Input Power | Rear Speaker | 100 W RMS |
| | Rear Top Speaker | 100 W RMS |
| Dimensions (W x H x D) | Approx. 130.0 mm x 211.5 mm x 191.2 mm (5.1 inch x 8.3 inch x 7.5 inch) | |

- Design and specifications are subject to change without notice.

Registered Trademarks and Licenses

All trademarks and trade names are the property of their respective owners.



Dolby, Dolby Vision, Dolby Atmos, and the double-D symbol are registered trademarks of Dolby Laboratories Licensing Corporation. Manufactured under license from Dolby Laboratories. Confidential unpublished works. Copyright © 2012–2020 Dolby Laboratories. All rights reserved.



For DTS patents, see <http://patents.dts.com>. Manufactured under license from DTS, Inc. (for companies headquartered in the U.S./Japan/Taiwan) or under license from DTS Licensing Limited (for all other companies). DTS, DTS:X, and the DTS:X logo are registered trademarks or trademarks of DTS, Inc. in the United States and other countries. © 2020 DTS, Inc. ALL RIGHTS RESERVED.



The **Bluetooth**® word mark and logos are registered trademarks owned by the **Bluetooth SIG**, Inc. and any use of such marks by LG Electronics is under license.

Other trademarks and trade names are those of their respective owners.



The terms HDMI, HDMI High-Definition Multimedia Interface, and the HDMI Logo are trademarks or registered trademarks of HDMI Licensing Administrator, Inc.

| What You Need to Know about Network Services

All information, data, documents, correspondence, downloads, files, text, images, photos, graphics, videos, webcasts, publications, tools, resources, software, code, programs, applets, widgets, applications, products, and any other content ("Content") and services and offerings ("Services") made available by a third-party are provided under the sole responsibility of the service providers that produced them.

Withholding, removal, or suspension of any or all of these Content and Services are not restricted, and the use of and access to Contents and Services provided through LG Electronics products by the service providers may be changed anytime without prior notice.

If you have any demands or issues regarding Content and Services, you can refer to the service provider's website for the most up-to-date information. LG Electronics is not responsible for consumer services related to Content and Services, and does not undertake any obligations. Any questions or requirements regarding Content and Services should be fulfilled directly by the respective content and service providers.

It is clear that LG Electronics is not responsible for any Content or Services, or any change, removal, or suspension of each Content or Service, and does not certify or guarantee the use of or access to such Content or Services.

| Open Source Software Notice Information

To obtain the source code under GPL, LGPL, MPL, and other open source licenses, that is contained in this product, please visit <http://opensource.lge.com>.

In addition to the source code, all referred license terms, warranty disclaimers and copyright notices are available for download.

LG Electronics will also provide open source code to you on CD-ROM for a charge covering the cost of performing such distribution (such as the cost of media, shipping, and handling) upon email request to opensource@lge.com.

This offer is valid for a period of three years after our last shipment of this product. This offer is valid to anyone in receipt of this information.

| Handling the Product

When shipping the Product

Please save the original shipping carton and packing materials. If you need to ship the product, for maximum protection, re-pack the product as it was originally packed at the factory.

Keeping the exterior surfaces clean

- Do not use volatile liquids such as insecticide spray near the product.
- Wiping with strong pressure may damage the surface.
- Do not leave rubber or plastic products in contact with the product for a long period of time.

Cleaning the product

To clean the product, use a soft, dry cloth. If the surfaces are extremely dirty, use a soft cloth lightly moistened with a mild detergent solution. Do not use strong solvents such as alcohol, benzene, or thinner, as these might damage the surface of the product.

