

Gaggenau
Instruction manual
說明手冊

VG 232 220 CA

Gas hob
瓦斯爐台

Table of contents

Intended use	3
Important safety information	4
Causes of damage	6
Environmental protection	6
Saving energy	6
Environmentally-friendly disposal	6
Familiarising yourself with your appliance	7
Gas hob	7
Visual signals of the luminous disc	7
Individual parts of the burners	8
Operating the appliance	8
Switching on	9
Switching on manually	9
Thermoelectric flame monitoring	9
Switching off	9
Residual heat indicator	9
Table of settings and tips	10
Tips for cooking and roasting	10
Information and tips regarding cookware	11
Suitable cooking vessels	11
Precautions for use	11
Cleaning and maintenance	12
Cleaning the appliance	12
Burnt-on dirt	12
Trouble shooting	13
After-sales service	14
E number and FD number	14

Additional information on products, accessories, replacement parts and services can be found at www.gaggenau.com and in the online shop www.gaggenau.com/zz/store

⚠ Intended use

Read these instructions carefully. Only then will you be able to operate your appliance safely and correctly. Retain the instruction manual and installation instructions for future use or for subsequent owners.

This appliance is only intended to be fully fitted in a kitchen. Observe the special installation instructions.

This appliance must be installed according to the installation instructions included.

Check the appliance for damage after unpacking it. Do not connect the appliance if it has been damaged in transport.

Only allow a licensed professional to connect the appliance. Damage caused by incorrect connection is not covered under warranty. Call the after-sales service if you want to convert your appliance to a different type of gas.

This appliance is intended for domestic use and the household environment only. This appliance must only be used to prepare food and drinks and must never be used as a heater. Do not leave the appliance unattended during operation. Only use the appliance indoors.

Do not install this appliance on boats or in vehicles.

This appliance is intended for use up to a maximum height of 4000 metres above sea level.

This appliance is not intended for operation with an external clock timer or a remote control.

Do not use covers. These can cause accidents, for example due to overheating, catching fire or materials shattering.

Only use safety devices or child protection grilles approved by ourselves. Unsuitable safety devices or child protection grilles may result in accidents.

This appliance may be used by children over the age of 8 years old and by persons with reduced physical, sensory or mental capabilities or by persons with a lack of experience or knowledge if they are supervised or are instructed by a person responsible for their safety how to use the appliance safely and have understood the associated hazards.

Children must not play with, on, or around the appliance. Children must not clean the appliance or carry out general maintenance unless they are at least 15 years old and are being supervised.

Keep children below the age of 8 years old at a safe distance from the appliance and power cable.

Close the safety valve on the gas supply line if the cooker will not be used for a prolonged period.

⚠ Important safety information

⚠ Warning – WHAT TO DO IF YOU SMELL GAS!

Escaping gas may cause an explosion.

If you smell gas or notice any faults in the gas installation:

- Immediately shut off the gas supply or close the gas cylinder valve.
- Immediately extinguish all naked flames and cigarettes.
- Do not use any light or appliance switches and do not pull any plugs out of sockets. Do not use any telephones or mobile phones within the building.
- Open windows and ventilate the room.
- Call the after-sales service or the gas supplier.

⚠ Warning – Risk of asphyxiation!

The use of a gas cooker leads to a build-up of heat, moisture and products of combustion in the room where the appliance is installed. Ensure that the installation room is well ventilated. The natural ventilation openings must be kept open or a mechanical ventilation device must be provided (e.g. an extractor hood). Intensive and persistent use of the appliance may mean that it is necessary to have additional ventilation (e.g. opening a window), or more effective ventilation (e.g. operating the existing mechanical ventilation device at a higher setting).

⚠ Warning – Risk of fire!

- Hot oil and fat can ignite very quickly. Never leave hot fat or oil unattended. Never use water to put out burning oil or fat. Switch off the hotplate. Extinguish flames carefully using a lid, fire blanket or something similar.
- The hotplates become very hot. Never place combustible items on the hob. Never place objects on the hob.
- The appliance becomes very hot and flammable materials could catch fire. Never store or use flammable objects (e.g. spray cans, cleaning agents) under the appliance or in its immediate vicinity. Never place flammable items on or in the appliance.
- When gas hotplates are in operation without any cookware placed on them, they can build up a lot of heat. The appliance and the extractor hood above it may become damaged or be set on fire. Grease residue in the filter of the extractor hood may ignite. Only operate the gas burners with cookware on them.
- If the burner does not ignite after 15 seconds, switch off the control knob and open the door or window in the room. Wait at least 1 minute before igniting the burner again.

⚠ Warning – Risk of burns!

- The appliance becomes hot during operation. Allow the appliance to cool down before cleaning.
- The hotplates and surrounding area (particularly the hob surround, if fitted) become very hot. Never touch the hot surfaces. Keep children at a safe distance.

- The accessible parts become very hot when in operation. Never touch hot parts. Keep children at a safe distance.
- When the appliance cover is closed, heat will accumulate. Only close the appliance cover when the appliance has cooled down. Never switch the appliance on with the appliance cover closed. Do not rest food on the appliance cover or use it to keep food warm.
- Empty cookware becomes extremely hot when set on a gas hotplate that is in operation. Never heat up empty cookware.
- If the liquefied gas bottle is not upright, liquefied propane/butane can enter the appliance. Intense darting flames may therefore escape from the burners. Components may become damaged and start to leak over time so that gas escapes uncontrollably. Both can cause burns. Always use liquefied gas bottles in an upright position.

⚠ Warning – Risk of injury!

- Incorrect repairs are dangerous. Repairs may only be carried out, and damaged power and gas lines replaced, by an after-sales engineer trained by us. If the appliance is faulty, unplug the mains plug or switch off the fuse in the fuse box. Shut off the gas supply. Contact the after-sales service.
- Faults or damage to the appliance are dangerous. Never switch on a faulty appliance. Unplug the appliance from the mains or switch off the circuit breaker in the fuse box. Shut off the gas supply. Contact the after-sales service.
- Unsuitable pan sizes, damaged or incorrectly positioned pans can cause serious injury. Observe the instructions which accompany the cookware.

⚠ Warning – Risk of electric shock and serious injury!

- The cable insulation on electrical appliances may melt when touching hot parts of the appliance. Never bring electrical appliance cables into contact with hot parts of the appliance.
- Do not use any high-pressure cleaners or steam cleaners, which can result in an electric shock.
- A defective appliance may cause electric shock. Never switch on a defective appliance. Unplug the appliance from the mains or switch off the circuit breaker in the fuse box. Contact the after-sales service.
- Incorrect repairs are dangerous. Repairs may only be carried out by one of our trained after-sales engineers. If the appliance is faulty, unplug the mains plug or switch off the fuse in the fuse box. Contact the after-sales service.

Causes of damage

Caution!

- **Risk of heat damage to adjacent appliances or kitchen units:** If the appliance is in operation for an extended period, heat and moisture will be generated. Additional ventilation is required. Open the window or switch on an extractor hood that discharges the extracted air and moisture outside the building.
- **Risk of damage to the appliance due to the build-up of heat:** Do not heat roasters, frying pans or grill stones using more than one burner at a time.
- **Malfunction:** Always turn the control knob to the "Off" position when the appliance is not being used.

Environmental protection

The sections below list a number of energy-saving tips and provide information on disposing of your appliance.

Saving energy

- Choose a burner of roughly the same size as your pan. Place the cookware in the middle.
- Use small saucepans for small quantities. Using a large saucepan with little in it consumes a lot of energy.
- Always place suitable lids on saucepans. Cooking without a lid consumes significantly more energy. Use a glass lid so that you can see into the pan without having to lift the lid.
- Cook with only a little water. This will save energy and preserve the vitamins and minerals in vegetables.
- Switch to a lower heat setting in good time. This will save energy.

Environmentally-friendly disposal

Dispose of packaging in an environmentally-friendly manner.



This appliance is labelled in accordance with European Directive 2012/19/EU concerning used electrical and electronic appliances (waste electrical and electronic equipment - WEEE). The guideline determines the framework for the return and recycling of used appliances as applicable throughout the EU.

Familiarising yourself with your appliance

In this section, we will explain the components and controls.

Gas hob

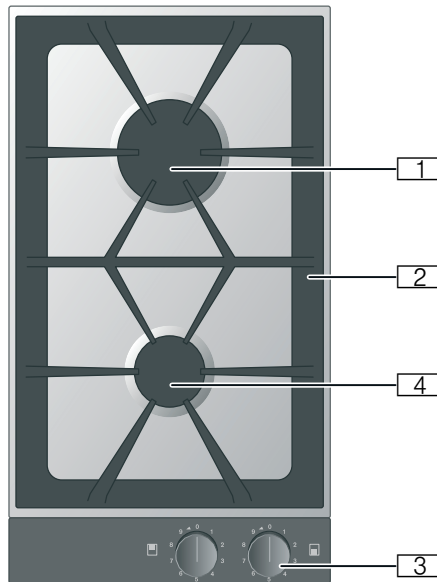

- 1 High-output burner 3.0 kW
- 2 Pan support
- 3 Control knob:
 0 = Burner switched off
 Power level 1 = Lowest setting
 Power level 9 = Highest setting
 ◀ Direction of rotation to switch on
- 4 Standard-output burner 1.9 kW

Visual signals of the luminous disc

The control knob is encircled by an illuminated ring that indicates a number of statuses and functions.

Indicator/symbol	Meaning
○ Off	Appliance OFF
● Lit orange	Appliance ON
● Slow flashing orange	Appliance OFF Residual heat indicator
☀ Flashing orange	Appliance fault Call the after-sales service.

Individual parts of the burners

Ensure that the burner parts are fitted in the correct position and are straight; otherwise, there may be ignition problems or problems during operation. The lugs must engage in the relevant recesses.

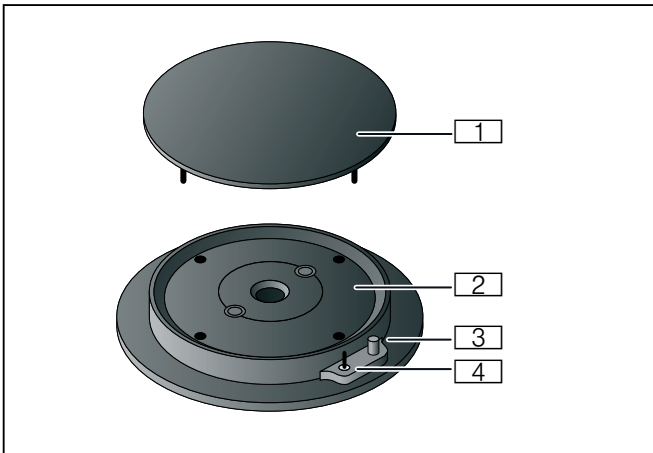

- 1 Burner cap
- 2 Burner head
- 3 Ignition plug
- 4 Thermocouple element for flame monitoring

Operating the appliance

Notes

- Only use the accessories specified. Do not line the stainless steel recess (e.g. with aluminium foil).
- Do not cover the ventilation openings on the back of the control panel.
- The burner and ignition plug must be clean and dry.
- Only light the burners if the pan supports and all burner parts are correctly fitted.
- To ignite a burner, firmly press the control knob down as far as possible and hold it there, then turn it to the required position.
- Once ignited, press and hold the control knob for approx. 2 to 4 seconds to enable the heat sensor that opens the gas flow to heat up first.
- If the flame does not ignite within 2 to 4 seconds, turn the control knob anti-clockwise to the lowest setting and, once ignited, turn it back to the highest setting. It can often be quicker to ignite the burner in the lowest setting because different gases have different ignition characteristics.
- When one burner is ignited, an ignition spark will also be generated at all the other burners.
- Do not touch the ignition plug while the gas appliance is being lit.
- It is important to keep the appliance clean. If the ignition plugs are dirty, this may cause ignition problems. Clean the ignition plugs regularly with a small, non-metallic brush. Take care to prevent the ignition plugs from suffering any heavy knocks.

Switching on

This appliance is equipped with a step valve. The markings on the control knob show you the output from power levels from 1 to 9.

Your gas hob comes with ignition plugs for electrical ignition.

- 1 Place a suitable item of cookware on the pan support.
- 2 Push in the control knob for your chosen burner and turn it anticlockwise to the power level you require. The burner ignites automatically.

Turn the control knob to set the power level.

Caution! Damage to the appliance

Never try to turn the control knob directly from position 0 to position 1, or from position 1 directly to position 0. Doing this will damage the step valve.

⚠ Warning – Risk of deflagration!

If the burner does not ignite after 15 seconds, switch off the control knob and open the door or window in the room. Wait at least 1 minute before igniting the burner again.

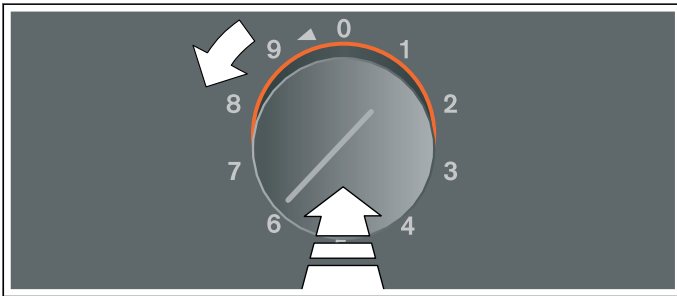

Switching on manually

During a power cut you can ignite the burners manually.

- 1 Place a suitable pot or pan on the pot grid.
- 2 Press the corresponding control knob and turn it anticlockwise to the required setting. Keep the control knob pressed.
- 3 Use a gas lighter or a match to ignite the burner. Keep the control knob pressed for a few seconds after ignition.

Note: The indicator on the illuminated ring remains off.

Thermoelectric flame monitoring

For your safety, the hob is fitted with thermoelectric flame monitoring. This prevents the flow of gas if the burner accidentally goes out while it is in use (e.g. due to draughts).

If the burner accidentally goes out while it is in use, turn the control knob to the 0 position and wait at least one minute before you ignite the burner again.

Switching off

Turn the control knob clockwise to position 0.

⚠ Warning – Risk of burns!

When the appliance cover is closed, heat will accumulate. Only close the appliance cover when the appliance has cooled down. Never switch the appliance on with the appliance cover closed. Do not rest food on the appliance cover or use it to keep food warm.

Residual heat indicator

After switching off the appliance, the illuminated ring on the control knob slowly flashes orange until the appliance has cooled enough for it to be safe to touch. Do not touch the appliance while the residual heat indicator is flashing.

Table of settings and tips

Power level	Cooking method	Examples
9	Heating	Water, clear soups
	Blanching	Vegetables
	Deep-frying	Chips, pastries
7 - 9	Searing	Meat
	Frying at high temperatures	Meat, potatoes
6 - 8	Simmering with the lid open	Liquids, dough-based foods
5 - 7	Baking	Flour-based food
	Frying at medium temperatures	Poultry, fish
4 - 5	Frying at low temperatures	Fried sausages, onions, egg dishes
	Defrosting	Frozen food
4	Poaching with the lid open	Dumplings, boiled sausages
	Warming	Vegetables, soups, stews
3 - 4	Braising	Beef olives, joints
	Stewing	Vegetables
2 - 4	Simmering with the lid on	Soups, vegetables
1	Soaking	Rice, rice pudding, cereals

Tips for cooking and roasting

The values given in the settings table must be looked upon as recommended values. The heat required depends not only on the type and condition of the food, but also the size and contents of the pot.

Due to the high performance of the cooktop, fat and oil will heat up quickly. Never leave the cooktop unattended, fat can ignite, food can burn.

Preferably use the rear cooking zones to prepare meals, that need longer to cook.

Preferably use the high output burners for brief cooking, deep fat frying and searing of large quantities.

Information and tips regarding cookware

The following information and tips have been provided to help you save energy and avoid damaging your cookware.

Suitable cooking vessels

Burner	Recommended pan base diameter	Minimum pan base diameter
Standard-output burner	140 - 200 mm	90 mm
High-output burner	180 - 220 mm	90 mm

Pans with a diameter of less than 90 mm or more than 200 mm (220 mm for the high-output burner) should not be used.

Maintain a distance of at least 50 mm between the item of cookware and flammable objects. Maintain a distance of at least 50 mm between the control knob or control panel and the pot or pan. The cookware must not touch the control panel or the control knob. The cookware must not protrude over the edge of the hob.

Precautions for use

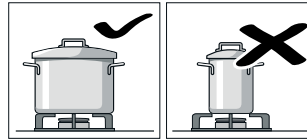

Use pots or pans which are the right size for each burner.

Do not use small pots or pans on large burners. The flame should not touch the sides of the pot.

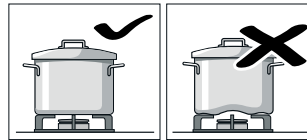

Do not use damaged pots or pans, which do not sit evenly on the cooktop, they may tip over.

Only use pots or pans with a thick, flat base.

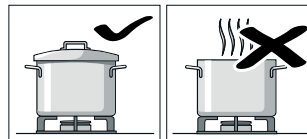

Do not cook without using a lid and make sure the lid is properly fitted. This wastes energy.

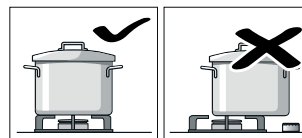

Always centre the pot or pan over the burner, otherwise it could tip over.

Do not place large pots on the burners near the control knobs. These may get damaged by the high temperatures.

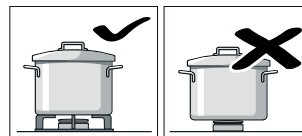

Place the pots or pans on the pan support, never directly on the burner.

Make sure that the pan supports and burner caps are correctly positioned before using the appliance.

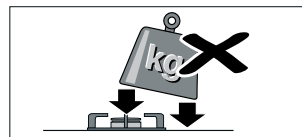

Pots or pans should be placed on the cooktop carefully.

Do not strike the cooktop and do not place excessive weight on it.

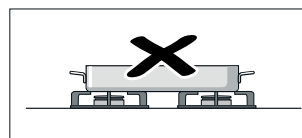

Do not heat a cooking vessel (e.g. roaster, pan, grill stone) on more than one burner at the same time. The resulting heat accumulation will damage the appliance.

Cleaning and maintenance

⚠ Warning – Risk of electric shock!

Do not use any high-pressure cleaners or steam cleaners, which can result in an electric shock.

⚠ Warning – Risk of burns!

The accessible parts become very hot when in operation. Never touch hot parts. Keep children at a safe distance.

Caution!

Risk of surface damage

Do not use these cleaners

- harsh or abrasive cleaning agents
- oven cleaners
- corrosive or aggressive cleaners, or those containing chlorine
- cleaning agents with a high alcohol content
- hard and scratchy sponges, brushes or scouring pads

If such an agent comes into contact with the appliance, wash it off immediately with water.

Thoroughly wash out new sponge cloths before using them!

Cleaning the appliance

Clean the appliance after each use once it has cooled down. Remove liquids that have boiled over or spilled immediately and do not allow any food remains to burn on.

Dry the burners thoroughly after cleaning. Only operate the appliance when the burners are dry. Damp burners can cause ignition problems and/or an unstable flame.

During assembly, make sure that the burner parts (catch tappets) are in the correct position. All parts must be straight.

Appliance part/ surface	Recommended cleaning
Stainless steel surfaces	<p>Clean using a soft, damp cloth and some washing-up liquid. Use a minimal amount of water when cleaning to prevent water from penetrating the appliance.</p> <p>Soak burnt-on remains with a small amount of soapy water; do not scour.</p> <p>Remove heavy soiling or yellow discolouration caused by heat using our stainless steel cleaner (item no. 00311499).</p>
Pan supports	<p>Carefully remove for cleaning. Soak in the sink. Clean using a scrubbing brush and washing-up liquid.</p> <p>Clean the area around the rubber buffers carefully so that they do not become detached.</p> <p>Rinse with clean water and dry before putting them back.</p> <p>You can also clean the pan supports in the dishwasher. This may cause the pan support to become lighter in colour. This does not affect its usability.</p>
Burner parts	<p>Clean using a soft, damp cloth and some washing-up liquid. Dry with a soft cloth. Make sure that the openings are not blocked.</p> <p>Make sure that no small parts are lost.</p> <p>Do not clean in the dishwasher.</p>
Control panel, control knobs	<p>Clean using a soft, damp cloth and a little washing-up liquid; the cloth must not be too wet. Dry with a soft cloth.</p> <p>If acidic substances (e.g. vinegar, ketchup, mustard, marinades, lemon juice) are spilled on the control panel, remove them immediately.</p> <p>Caution! Damage to the appliance Do not detach the control knobs to clean them.</p>

Burnt-on dirt

For hard-to-remove, burnt-on dirt, you can order a cleaning gel from our online shop, from your specialist retailer or via our after-sales service (item number 00311859). It is suitable for pan supports and the stainless steel recess. If necessary, let the dirt soak overnight. Follow the instructions on the cleaning product.

Caution!

Damage to the surface

Do not use the cleaning gel on the burner parts, the control panel or the control knobs.

Trouble shooting

Warning – Risk of electric shock!

Incorrect repairs are dangerous. Repairs may only be carried out by one of our trained after-sales engineers. If the appliance is faulty, unplug the mains plug or switch off the fuse in the fuse box. Contact the after-sales service.

Faults often have simple explanations. Please read the information in the table before calling the after-sales service.

Fault	Possible cause	Solution
Malfunction of the general electrical system.	The household fuse has tripped.	Check the fuse box if the fuse has tripped.
The electric ignition does not work.	There may be food or cleaning products stuck between the ignition sparkers and the burners.	The space between the ignition sparker and the burner must be clean.
	The burners are wet.	Dry the burner caps carefully.
	The burner caps are not correctly positioned.	Check that the burner caps are correctly positioned.
	Power cut	Ignite the burner with a lighter or a match.
The burner flame is not uniform.	The burner components are not correctly positioned.	Ensure the components are correctly positioned.
	The grooves on the burner are dirty.	Clean the grooves on the burner.
The gas flow is not normal or there is no gas.	The gas supply is blocked via gas taps.	Open all gas taps.
	If the gas is supplied from a gas cylinder, check that this is not empty.	Change the gas cylinder.
The kitchen smells of gas.	There may be a leak in the gas cylinder coupling.	Check that the coupling is sound.
The burner goes off after ignition.	The control knob was not held down for long enough.	Once the burner is on, hold the control knob down a few seconds longer. Fully press control knob.
	The grooves on the burner are dirty.	Clean the grooves on the burner.

After-sales service

Our after-sales service is there for you if your appliance needs to be repaired. We will always find an appropriate solution, also in order to avoid after-sales personnel having to make unnecessary visits.

E number and FD number

When calling us, please quote the full product number (E no.) and the production number (FD no.) so that we can provide you with the correct advice. The rating plate that features these numbers can be found on the underside of the appliance.

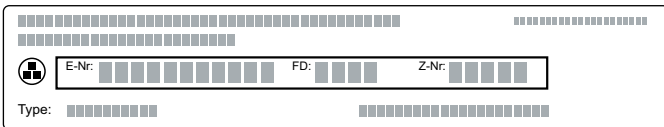

To save time, you can make a note of the numbers for your appliance and the telephone number of the after-sales service in the space below in case you need them.

E no.

FD no.

After-sales service

Please note that a visit from an after-sales service engineer is not free of charge in the event that the appliance has been misused, even during the warranty period.

Please find the contact data of all countries in the enclosed customer service list.

To book an engineer visit and product advice

GB 0344 892 8988
Calls charged at local or mobile rate.

IE 01450 2655
0.03 € per minute at peak.
Off peak 0.0088 € per minute.

AU 1300 368 339

NZ 09 477 0492

Trust the expertise of the manufacturer, and rest assured that the repair will be carried out by trained service technicians using original spare parts for your domestic appliance.

目錄

用途	16
重要安全資訊	17
損壞原因	18
環境保護	18
節能	18
符合環保規定的廢棄處理	18
請熟悉您的電器。	19
瓦斯爐	19
照明裝置的視覺訊號	19
燃燒器的個別零件	19
操作電器	20
開啟	20
手動開啟	20
電熱式火侯監控	20
關閉	20
餘熱指示燈	20
設定與提示總表	21
烹調 與燒烤的祕訣	21
關於鍋具的提示與資訊	21
適用的 烹調工具	21
使用時的注意事項	21
清潔與維護	22
清潔本電器	22
燒焦的污垢	22
疑難排解	23
售後服務	23
產品編號及製造編號	23

關於產品、配件、備品與保養的其他資訊，請參閱
www.gaggenau.com/zz/store 與線上商店
www.gaggenau-eshop.com

⚠ 用途

請詳細閱讀說明。以確保能安全且正確的使用本產品。請妥善保管說明手冊及安裝說明，以便未來使用或交給下一位持有人。

本產品僅可安裝於廚房使用。請遵守原廠安裝說明。

本電器必須根據隨附的安裝說明進行安裝。

開箱後請檢查電器有無損壞。若在運送過程中已發生損壞，請勿將電器連接電源。

務必由持有執照的專業人士將電器接電。因不當連接而造成的損壞，不在保固範圍之內。若您想要將本電器轉換成使用不同種類的瓦斯，請聯絡客服中心。

本電器主要用於室內與居家環境。本電器僅適用於準備食物和飲品，不可當做暖爐來使用。操作時務必在場監督。僅供室內使用。

請不要將本電器安裝在船隻或運輸工具上。

本電器僅適用於最高海拔 4000 公尺以下的地區。

本產品不適合與外部計時器或遙控操作搭配使用。

請勿使用蓋板。其可能因過熱而造成意外事故，如起火或材料碎裂。

只能使用經我們認可的安全裝置或兒童護欄。不適當的安全裝置或兒童護欄可能會造成意外。

8 歲以上的兒童，身體、感官或精神有障礙者，以及欠缺使用此產品經驗和知識者，可由監護人在旁監督或指導如何安全使用並明瞭其危險性後，使用本產品。

請勿讓孩童將本機當成玩具或在其周圍嬉戲。15 歲以上的孩童除非在監督下，否則不得進行清潔及保養的工作。

請確保 8 歲以下的孩童遠離本機及電源線。

若電器將有一段長時間不使用，請關閉瓦斯供給管線上的安全閥。

⚠ 重要安全資訊

⚠ 警告 – 聞到瓦斯味時該做的事！

漏出的瓦斯可能會導致爆炸。

若聞到瓦斯味 或發現瓦斯安裝上有缺陷：

- 立刻關閉瓦斯供給或關閉 瓦斯罐的閥。
- 立刻 滅掉所有暴露出的火焰與煙霧。
- 請勿 開啟任何光源或電器電源，以及將任何插頭從插座拔掉。請勿在建築物裡使用電話或手機。
- 打開窗戶 並使房間內通風。
- 請聯絡售後服務 中心或瓦斯行。

⚠ 警告 – 窒息風險！

使用瓦斯爐將會導致安裝有本電器的房間內產生熱、濕氣及燃燒產物。請確保安裝本電器的房間內有足夠的通風。請務必將通風口打開或使用機械式抽風機（例如抽油煙機）。若密集地或持續地使用本電器，需有額外的通風（例如打開窗戶）或更有效的通風（例如將既有的機械式抽風機開大一點）。

⚠ 警告 – 火災風險！

- 高溫油脂可能會快速點燃。請務必看守並注意高溫油脂的使用。請勿使用水撲滅正在燃燒的油脂。關閉加熱區。小心使用鍋蓋、滅火毯或類似的物品來滅火。
- 加熱區變得非常熱。切勿將易燃物品放置於爐具上。切勿將物品放置於爐具上。
- 電器變得高溫且易燃物可能會著火。請勿在本電器的下方或鄰近處放置或使用易燃物品（例如：噴罐、清潔劑）。請勿在本電器的上方或內部放置易燃物品。
- 如果瓦斯加熱板運作中卻沒有放置任何廚具，此時瓦斯加熱板將產生高溫。本電器與其上方的抽油煙機可能會損壞或起火。抽油煙機的濾網上所殘留的油脂可能會引起點火。務必將廚具放妥之後再開啟瓦斯燃燒器。
- 假如燃燒器在15秒後還是沒有點燃，請關閉控制旋鈕並開啟房間內的門窗。再次開啟燃燒器前，需等待至少1分鐘。

⚠ 警告 – 燙傷風險！

- 電器在運作時會發燙。清潔前，請務必等待電器完全冷卻。
- 加熱區及周圍區域（特別是爐具周圍）會變得非常熱。切勿觸碰高溫表面。兒童應保持安全距離。
- 運作時可接觸部分會變得非常高溫。請勿觸碰高溫部件。兒童應保持安全距離。
- 當電器的上蓋關閉時，熱能會累積。請在本電器完全冷卻後再使用電器上蓋。請勿在電器上蓋關閉的狀態下開啟本電器的電源。請勿放置食物在電器上蓋或用其來幫助食物保溫。
- 空鍋具放在運轉中的瓦斯加熱板上會變得非常燙。請勿加熱空的鍋具。
- 若液態瓦斯罐沒有垂直擺放好，液態丙烷 / 丁烷可能會流入電器內。強烈猛烈的火焰可能會因此從燃燒器冒出。組件可能會損壞並隨著時間開始外漏，瓦斯也因此會無法控制地竄出。兩者皆會導致燙傷。使用液態瓦斯罐時請務必垂直擺放好。

⚠ 警告 – 受傷風險！

- 不當維修會造成危險。請由受過本公司訓練的售服工程師進行維修或更換損壞的電源·瓦斯管線。烤箱如有故障，請拔掉烤箱插頭或更換保險絲盒內的保險絲。關閉瓦斯供給。請聯絡客服中心。
- 有缺陷或損傷的電器非常危險。電器若有缺陷請勿開啟其電源。請拔掉烤箱插頭或關閉保險絲盒內的斷路器。關閉瓦斯供給。請聯絡客服中心。
- 尺寸不合適的平底鍋、已受損或沒放置好的平底鍋 將導致受傷。請遵照鍋具隨附的指示。

⚠ 警告 – 觸電與嚴重傷害風險！

- 電器上的電源線絕緣層與機體的高熱零件接觸時可能會融化。請勿讓電源線與機體的高熱零件接觸。

- 請勿使用任何高壓清潔器或蒸氣清洗機，以免觸電。
- 有瑕疵的電器可能會導致觸電。請勿啟動有瑕疵的電器。請拔掉電器插頭或關閉保險絲盒內的斷路器。請聯絡售後服務中心。
- 不當維修會造成危險。維修作業需由我們的專業售後服務工程師負責。電器如有故障，請拔掉電器插頭或更換保險絲盒內的保險絲。請聯絡客服中心。

損壞原因

注意!

- **對鄰近電器或廚房用具造成熱損壞：**當電器運轉了一段時間後會產生熱與濕氣。此時需要有額外的通風。打開窗戶或啟動排油煙機將電器排出的空氣及溼氣排放到建築物外面。
- **熱能累積會導致電器損壞：**請勿一次使用一個以上的燃燒器來加熱烤盤、平底鍋或燒烤石。
- **故障：**當電器未使用時，請務必將控制旋鈕轉至「關閉」位置。

環境保護

下一個章節裡，我們明列了節能秘訣與電器廢棄處理相關資訊。

節能

- 選擇和您的鍋具大小相近的燃燒器。將鍋具置於中央。
- 少量烹調時請使用小型湯鍋。少量烹調時使用大型湯鍋會消耗過多的能源。
- 使用適合湯鍋的蓋子。烹調時不加蓋將會消耗較多的能耗。玻璃蓋可方便您不打開蓋子便看到裡面的情況。
- 使用少量的水烹調。既省能源又能保存蔬菜中的維生素和礦物質。
- 及時切換至較低的加熱設定。如此可以節省能源。

符合環保規定的廢棄處理

請以環保的方式將包裝丟棄。



本電器 根據歐盟關於使用過的電器及電子產品的指令 2012/19/EU (使用過的電器及電子產品 - WEEE) 貼有 相關標籤。該指令規定歐盟範圍內 舊電器退還及回收的框架。

請熟悉您的電器。

在這個章節裡，我們會解釋各個元件及控制鈕。

瓦斯爐

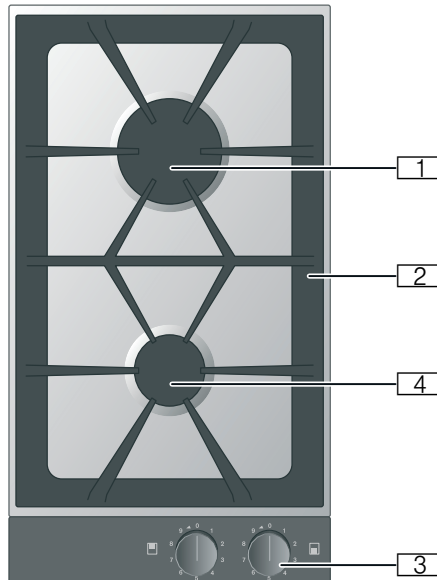

- 1 高輸出功率爐頭 3.0 kW
- 2 爐架
- 3 控制旋鈕:
0 = 關掉燃燒器
火力1 = 最低火力設定
火力9 = 最高火力設定
◀ 開啟的旋轉方向
- 4 標準輸出功率爐頭 1.9 kW

照明裝置的視覺訊號

控制旋鈕周圍的發光圓環代表各種狀態和功能。

指示燈 / 符號	說明
○ 關	電器關
● 亮橘燈	電器開
● 緩慢閃爍橘燈	電器關 餘溫指示燈
☀ 閃爍橘燈	電器故障 請聯絡客戶服務中心。

燃燒器的個別零件

請確保燃燒器的零件均安裝於正確位置而且平直無彎曲，否則可能出現點火或操作問題。固定鉤必須咬合至相應的凹槽。

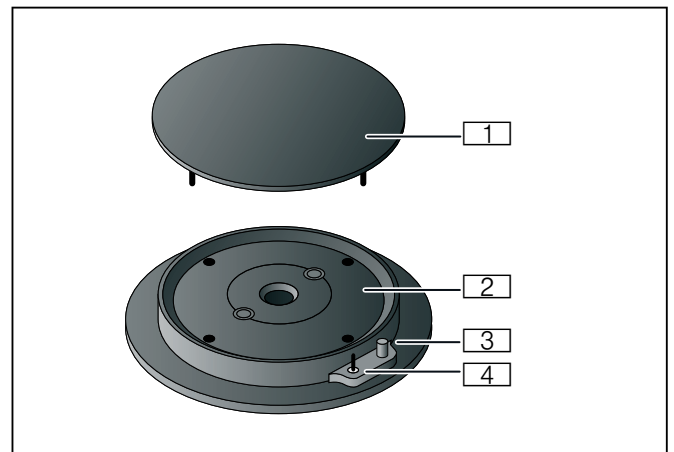

- 1 燃燒器蓋
- 2 燃燒器前端
- 3 點火器
- 4 用於火焰監控的熱電偶元件

操作電器

提示

- 只能使用指定配件。請勿遮蓋不鏽鋼凹槽（例如用鋁箔蓋住）。
- 請勿遮蓋控制面板後方的通風口。
- 燃燒器和點火器必須保持清潔乾燥。
- 請先確認爐架和所有燃燒器組件都已正確安裝，再將燃燒器點火。
- 要將燃燒器點火，請將控制旋鈕整個按下後轉至所需的位置。
- 點火後，按住控制旋鈕約2至4秒來啟動熱感應器，讓它打開瓦斯氣流優先加熱。
- 若在2至4秒內未點火，請將控制旋鈕逆時針轉至最低火力設定，點火後，請轉到最高火力設定。因不同的瓦斯有不同的點火特性，在最低火力設定時通常可以較快讓燃燒器點火。
- 一個燃燒器點火時，其他燃燒器的也會出現點火器的火花。
- 當瓦斯電器正在點燃時，請勿觸碰點火器。
- 保持電器的清潔非常重要。若點火器骯髒，點火時可能會出現問題。定期使用小型非金屬刷子清潔點火器。請小心維護，避免點火器受到嚴重撞擊。

開啟

本電器配備有步進閥。控制旋鈕上的標記表示輸出火力1至9。

瓦斯爐配備有點火器進行電力點火。

- 1 請在爐架上放置適當的鍋具。
- 2 按壓所選燃燒器的控制旋鈕，並逆時針轉動到您需要的火力。
燃燒器將自動點火。

轉動控制旋鈕以設定火力。

注意！ 電器損壞

請不要將旋鈕從位置0直接轉到位置1，反之亦然，這樣會讓步進閥受損。

⚠ 警告 – 爆燃風險！

假如燃燒器在15秒後還是沒有點燃，請關閉控制旋鈕並開啟房間內的門窗。再次開啟燃燒器前，需等待至少1分鐘。

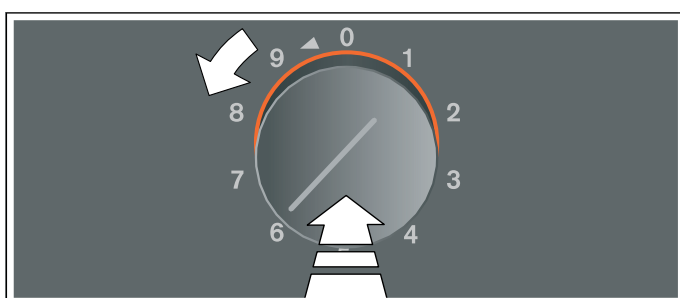

手動開啟

斷電時可手動將燃燒器點火。

- 1 請在鍋架上放置適當的鍋子或平底鍋。
- 2 按壓所選燃燒器的控制旋鈕，並逆時針轉動到您需要的火力。請將控制旋鈕保持在按下的狀態。
- 3 請使用瓦斯點火器或火柴來將燃燒器點火。點火後請將控制旋鈕保持在按下的狀態數秒。

提示：發光圓環上的指示燈保持熄滅。

電熱式火侯監控

瓦斯爐上附有電熱式火侯監控以保護您的安全。如此得以防止燃燒器使用時不小心熄滅而導致瓦斯外洩（例如有風吹來）。

若燃燒器使用時不小心熄滅，請將控制旋鈕轉至0的位置，並稍待一分鐘後再度將燃燒器點火。

關閉

將控制旋鈕順時針轉至0的位置。

⚠ 警告 – 燙傷風險！

當電器的上蓋關閉時，熱能會累積。請在本電器完全冷卻後再使用電器上蓋。請勿在電器上蓋關閉的狀態下開啟本電器的電源。請勿放置食物在電器上蓋或用其來幫助食物保溫。

餘熱指示燈

關掉電器後，控制旋鈕上的發光圓環會緩緩閃爍橘燈，直到電器完全冷卻可以觸摸後才會停止。餘溫指示燈仍在閃爍時切勿觸碰電器。

設定與提示總表

火力	烹調方法	範例
9	加熱	水、清湯
	汆燙	蔬菜
	油炸	炸薯條、酥皮點心
7 - 9	燒炙	肉類
	高溫油煎	肉、馬鈴薯
6 - 8	開蓋煨燉	液體、麵團類食物
5 - 7	烘焙	麵粉類食物
	中溫油煎	禽肉、魚類
4 - 5	低溫油煎	油煎香腸、洋蔥、蛋類料理
	解凍	結凍的食物
4	打開蓋水煮	餃子、水煮過的香腸
	覆熱	蔬菜、湯、燉菜
3 - 4	悶煮	橄欖牛肉卷
	燉	蔬菜
2 - 4	加蓋煨燉	湯、蔬菜
1	浸泡	米、米飯布丁、穀類

烹調 與燒烤的祕訣

設定列表裡的數值僅能當做參考數值。所須的加熱不僅依照食物的類型與狀態有所不同，也受到鍋子的尺寸與內裝物的影響。

由於本產品為高效能瓦斯爐，因此可快速加熱油脂和油。請千萬不可放置瓦斯爐不管，油脂可能會引發點火，食物可能會燒起來。

最好能使用後方烹調區來準備肉品，會花比較久的時間。

最好能使用高輸出燃燒器來料理快速烹調食物、油炸以及大量燒炙食物。

關於鍋具的提示與資訊

以下提供您節能並防止鍋具損壞的資訊和提示。

適用的 烹調工具

燃燒器	建議的鍋底直徑	最小鍋底直徑
標準輸出功率燃燒器	140 - 200公釐	90公釐
高輸出功率燃燒器	180 - 220公釐	90公釐

請勿使用直徑小於90公釐或大於200公釐（高輸出功率燃燒器為220公釐）的平底鍋。

鍋具和可燃物體之間必須保持至少50公釐的距離。控制旋鈕或控制面板和鍋子或平底鍋之間必須保持至少50公釐的距離。鍋具不可碰觸控制面板或控制旋鈕。鍋具不可突出爐具邊緣。

使用時的注意事項

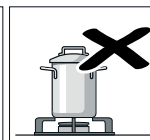
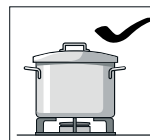

請使用適合各燃燒器 尺寸的鍋子或平底鍋。

請勿在大的燃燒器上使用過小的鍋子或平底鍋。火焰不可碰觸到鍋子的邊緣。

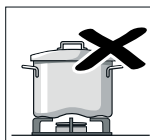
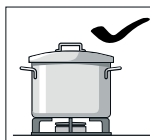

請勿使用已損壞的鍋子或平底鍋，這樣的器具無法在瓦斯爐上平均放置而可能導致傾斜外漏。

請務必使用帶有厚平底的鍋子或平底鍋。

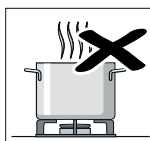
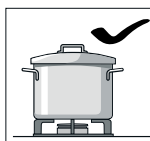

請勿在沒有使用蓋子的狀態下烹調並確保蓋子的尺寸合適。如此會造成能源浪費。

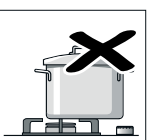
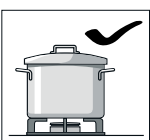

請務必將鍋子或平底鍋擺放在燃燒器的中間，否則會傾斜外漏。

請勿在靠近控制旋鈕的燃燒器上放置過大的鍋子。這些部分可能會因為高溫而損壞。

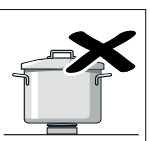
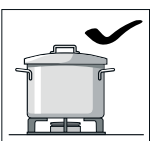

將鍋子或平底鍋放置於爐架上，務必不要直接放在燃燒器上。

使用本電器前請確認爐架與爐芯帽的位置有擺放正確。

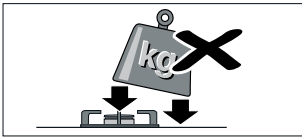

鍋子或平底鍋必須小心地放置在瓦斯爐上。

請勿敲打本瓦斯爐以及於上方放置過重的物品。

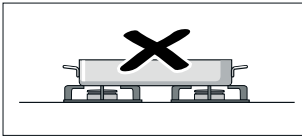

請勿同時使用一個以上的燃燒器來加熱烹調器具(例如烘烤器、平底鍋、燒烤石)。所有加熱的累積能量將導致電器損壞。

清潔與維護

⚠ 警告 – 觸電風險!

請勿使用任何高壓清潔器或蒸氣清洗機，以免觸電。

⚠ 警告 – 燙傷風險!

運作時可接觸部分會變得非常高溫。請勿觸碰高溫部件。兒童應保持安全距離。

注意!

小心損害表面

請勿使用以下的清潔用品

- 強效或腐蝕性的清潔劑
- 爐用清潔劑
- 具腐蝕性或強效清潔劑，或含氯的清潔劑
- 含高酒精成份的清潔劑
- 硬質與易刮傷的海綿，刷子或百潔布

若瓦斯爐正面不慎接觸到此類清潔劑，請立即用清水洗淨。

使用前，請用新的海綿布徹底清潔!

清潔本電器

每次使用完，請在電器冷卻後清潔。請立即清除溢出或濺出的液體，不要讓任何食物殘渣焦掉。

清潔完成後請徹底擦乾燃燒器。請務必在燃燒器乾燥的狀態下操作本電器。潮濕的燃燒器將導致點火問題和 / 或火候不穩定。

安裝時請確認燃燒器組件(定位桿)裝於正確的位置。所有組件必須平直無彎曲。

電器組件 / 表面	推薦的清潔方式
不鏽鋼表面	<p>用濕布沾一些清潔液進行清潔。請確保清潔時僅使用最少量的水以避免水滲入電器內。</p> <p>請將燒焦的殘渣浸泡在少量的肥皂水裡，並請不要刷洗。</p> <p>請使用本公司的不鏽鋼清潔劑(項目編號00311499)去除頑強污垢或由加熱溫度導致的泛黃。</p>
爐架	<p>清潔前小心地取下。浸泡在水槽裡。用刷子及清潔劑清洗。</p> <p>請小心清潔橡膠緩衝條的四周以避免其脫落。</p> <p>用清水沖洗並晾乾，然後裝回。</p> <p>也可以用洗碗機清洗爐架。這樣可能會讓爐架顏色變淺。這不會影響使用。</p>
燃燒器組件	<p>用濕布沾一些清潔液進行清潔。用軟布將其擦乾。請確認開口處沒有受到阻塞。</p> <p>請確認沒有遺失任何小零件。</p> <p>請勿用洗碗機清洗。</p>
控制旋鈕、控制旋鈕	<p>用濕布沾一些清潔液進行清潔，但濕布不能太濕。用軟布將其擦乾。</p> <p>若酸性物質(例如醋、蕃茄醬、芥末醬、醃醬或檸檬汁)濺到控制面板上，請立刻清理。</p> <p>注意! 電器損壞 清潔時請勿拆下控制旋鈕。</p>

燒焦的污垢

針對難以清除的燒焦污垢，可向線上商店、專業零售商或售後服務中心購買清潔凝膠(項目編號00311859)。本清潔凝膠適用於爐架與不鏽鋼凹槽。若有需要可將污垢浸泡隔夜。請遵循清潔產品上的指示。

注意!

造成表面損壞

請勿在燃燒器組件、控制面板或控制旋鈕上使用清潔凝膠。

疑難排解

⚠ 警告 – 觸電風險!

不當維修會造成危險。維修作業需由我們的專業售後服務工程師負責。電器如有故障，請拔掉電器插頭或更換保險絲盒內的保險絲。請聯絡客服中心。

故障的原因通常很單純。在聯繫售後服務中心前，請先閱讀本表的資訊。

故障錯誤	可能原因	解決方法
一般電源系統的故障。	家裡的保險絲跳掉了。	請確認保險絲盒裡的保險絲 是否已跳掉。
電點火 無法正常運作。	可能有食物或清潔劑 卡在點火器和燃燒器之間。 燃燒器潮溼。 爐芯帽的位置沒有 放置正確。 停電	請務必將 點火器和燃燒器之間的空間打掃乾淨。 仔細擦乾爐芯帽。 請確認爐芯帽的 位置有放置正確。 用打火機或火柴 將燃燒器點火。
燃燒器 的火不均勻。	燃燒器的組件位置 沒有放置正確。 燃燒器的溝槽 有髒污。	請確認燃燒器的組件位置 有放置正確。 將燃燒器的溝槽 打掃乾淨。
瓦斯管線不順或沒有瓦斯了。	瓦斯龍頭的供給阻塞。 若是由瓦斯罐 供給瓦斯，請確認瓦斯罐不是空的。	打開所有的瓦斯龍頭。 更換瓦斯罐。
廚房裡有瓦斯味。	瓦斯罐連接處 可能有外漏。	請確認連接處是否 完整。
燃燒器 點火後又熄滅。	扳下 控制旋鈕的時間不夠久。 燃燒器的溝槽 有髒污。	燃燒器開啟後，將控制旋鈕扳下數秒之久。 整個按下控制旋鈕。 將燃燒器的溝槽 打掃乾淨。

售後服務

若您的電器需要維修，請聯絡我們的客服中心。我們一定會找出適合的解決方案，同時避免售後服務人員進行不必要的拜訪。

請注意，若未根據使用說明書使用本電器，即使在保固期內，售後服務技師到府服務非免費的服務。

各國的聯絡資訊請參閱附件的客戶服務列表。

預約技師到府服務以及產品諮詢

TW 0800 368 888
免付費電話

製造商的專業技術值得信賴；請放心將您的居家電氣用品交給我們，其維修工作皆由訓練精良的客服技術人員執行並且使用原廠備用零件。

產品編號及製造編號

與我們聯絡時，請提供完整的產品編號 (E no.) 和製造編號 (FD no.)，以便我們提供正確的建議。您可在電器底部找到附有這些數字的銘牌。

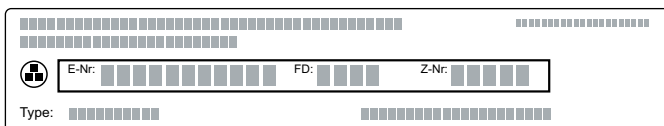

為節省時間，您可記下其編號及下方的售後服務中心電話，以備不時之需。

產品編號
(E no.)

生產序號
(FD no.)

售後服務中心 ☎

Gaggenau Hausgeräte GmbH
Carl-Wery-Straße 34
81739 München
GERMANY
www.gaggenau.com

9001409020 (981121)
en, zh-tw



GAGGENAU