



## 使用保養指南

適用型號: 8TWF5620HW/8TWF6620HW

## Use and Care Guide

Applicable models: 8TWF5620HW/8TWF6620HW

### 滾筒洗衣機

### Front-Loading Automatic Washer

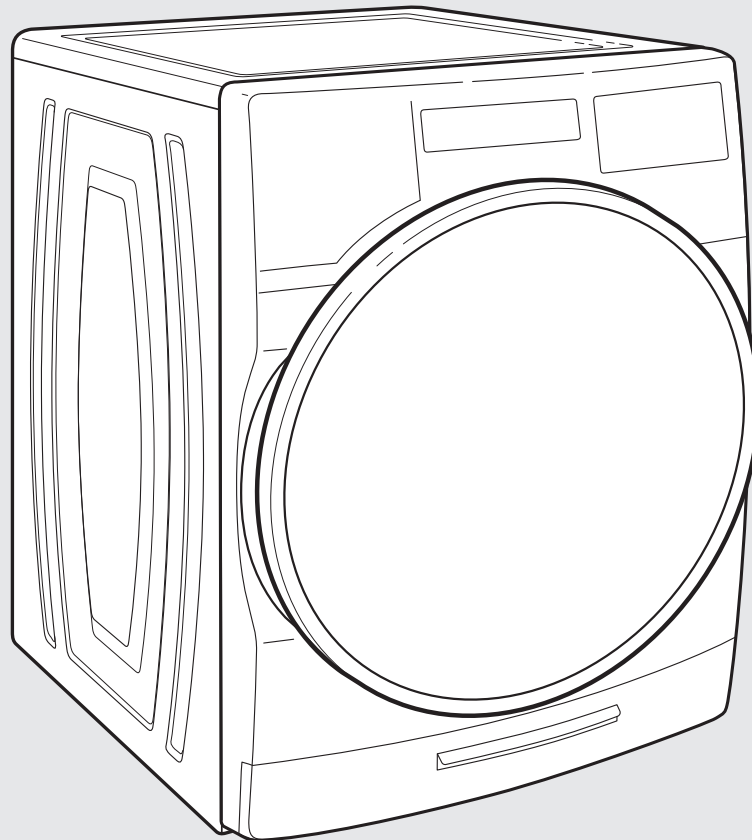

若您有任何疑問或問題，請造訪網站：[www.whirlpool.com.tw](http://www.whirlpool.com.tw)。  
If you have any problems or questions, visit us at [www.whirlpool.com.tw](http://www.whirlpool.com.tw).



專為使用 HE 高效能洗衣劑而設計。  
Designed to use only HE  
High Efficiency detergents.

## 目錄

產品規格 .....	2
洗衣機安全.....	3
配件 .....	4
控制面板和功能 .....	5
行程指南 .....	8
選擇正確的洗衣劑.....	11
使用洗劑盒.....	12
使用洗衣機.....	13
洗衣機維護.....	17
故障排除 .....	21
幫助和服務.....	30

## TABLE OF CONTENTS

PRODUCT SPECIFICATIONS.....	31
WASHER SAFETY .....	32
ACCESSORIES.....	33
CONTROL PANEL AND FEATURES .....	34
CYCLE GUIDE .....	37
CHOOSING THE RIGHT DETERGENT .....	40
USING THE DISPENSERS.....	41
USING YOUR WASHER .....	42
WASHER MAINTENANCE .....	46
TROUBLESHOOTING .....	50
ASSISTANCE AND SERVICE.....	Back Cover

## 產品規格：

機型	8TWFV5620HW	8TWFV6620HW
商品名稱	洗衣機	洗衣機
適用電源	120 V / 60 Hz	120 V / 60 Hz
最大洗衣量(乾燥衣物)	17.0 kg	17.0 kg
適用水壓	0.03~0.7 MPa	0.03~0.7 MPa
額定消耗電功率	500 W	1,000 W
最高旋轉速度	1,200 rpm	1,200 rpm
產品顏色說明(末碼)	W=白	W=白
重量	96 kg	107 kg
外觀尺寸(高 x 寬 x 深)	982 x 686 x 802 (mm)	982 x 686 x 802 (mm)

註: 規格以實際的機身銘牌為主。

如需查詢RoHs資訊，請瀏覽官方網站: [www.whirlpool.com.tw](http://www.whirlpool.com.tw)。

# 洗衣機安全

## 您與他人的安全都非常重要。

本公司已在這份手冊與電器上提供許多重要的安全提示訊息，請務必一一閱讀並遵守。



這是安全警示符號。

此符號表示存在可能導致您或他人傷亡的潛在危險。

所有安全提示訊息的前方都有安全警示符號以及「危險」或「警告」字樣。分別代表：



若不立即遵照指示，將導致您死亡或重傷。



若不遵照指示，將導致您死亡或重傷。

所有安全提示訊息都會告訴您有哪些潛在危險、如何降低受傷機率，以及若不遵守指示會有什麼後果。

## 重要安全說明

**警告：**為了減少使用洗衣機時發生火災、觸電或人身傷害的危險，請遵守以下基本預防措施，包含下列各項：

- 使用洗衣機之前，請詳讀所有的說明。
- 本電器不預期供生理、感知、心智能力、經驗或知識不足之使用者(包含孩童)使用，除非在對其負有安全責任的人員之監督或指導下安全使用。
- 不要去洗滌那些曾經被汽油、乾洗溶劑、易燃或容易爆炸的物質所清洗過、洗滌過、浸泡過的衣物，因為它們會釋放出可能燃燒或者爆炸的氣體。
- 不要加入汽油、乾洗溶劑或其他易燃或爆炸之物質到洗衣水裏面，它們會釋放出可能燃燒或者爆炸的氣體。
- 在某些情況下，如果兩個星期或更長沒有使用的熱水系統可能會產生氫氣。氫氣是易爆炸氣體。如果熱水系統有很長一段時間未使用，在使用洗衣機之前，打開水龍頭，讓水在每個水龍頭都流出幾分鐘。這樣可以釋放掉任何聚集的氫氣。由於該氣體是易燃性的，在此時請不要吸煙或者使用火苗。
- 不要讓小孩在洗衣機上或洗衣機內玩耍。當洗衣機在小孩附近使用時，請仔細照顧小孩。
- 在停止使用或棄置洗衣機前，請將洗衣機門或上蓋拆除。
- 當洗衣槽、脫水槽或洗衣棒在轉動時，請不要將手伸入洗衣機內。
- 請不要將洗衣機安裝或存放在室外日曬雨淋之地方。
- 請勿擅自更改控制器。
- 請不要擅自修理或者更換任何洗衣機零件，除非您具有修理技能及明確理解本使用或維護指南或其他用戶維修說明書所指定的修理方法，否則請別擅自修理。
- 參閱“電源要求”章節之接地說明作好接地。
- 若電源線損壞時，必須由製造廠或其服務處或具有類似資格的人員更換以避免危險。

**請妥善保存上述安全說明**

## 附件：

---

### 安裝和保養配件

原廠認證零件 - 這代表專為此款洗衣機設計的高品質零件與配件。通過時間考驗的工程符合我們嚴格的品質規範。

---

### 原廠認證零件

---

#### 專為此款洗衣機設計的配件：

請利用下列惠而浦原廠配件訂製您的洗衣機與乾衣機。  
更多配件選擇和訂購相關資訊，請致電：0800-258-558，  
請造訪網站：[www.whirlpool.com.tw](http://www.whirlpool.com.tw)

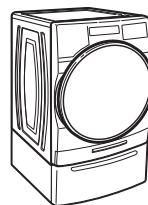

#### 15" 底座

搭配洗衣機顏色的底座，能將機器升高至更舒適的工作高度。大型抽屜可提供方便的貯存空間。

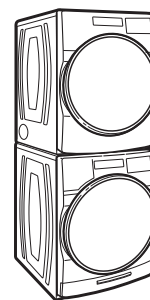

#### 堆疊配件

若有空間考量，堆疊配件可讓您把乾衣機安裝在洗衣機的上方。

# 控制面板和功能

備註：

- 並非所有機種都提供所有功能和行程。
- 控制面板具有靈敏的表面，因此只要以手指輕輕觸壓即會反應。為確保已記錄您的選擇，請用指尖而非指甲觸壓控制面板。選擇特定設定或功能時，只要觸碰對應的按鈕即可。
- 若您的機種有實體按鈕，請確認您有確實按下按鈕。
- 行程完成後，將記錄您的設定和選項選擇，以供下次再使用該行程。然而，若洗衣機電源中斷，將返回工廠預設的設定。

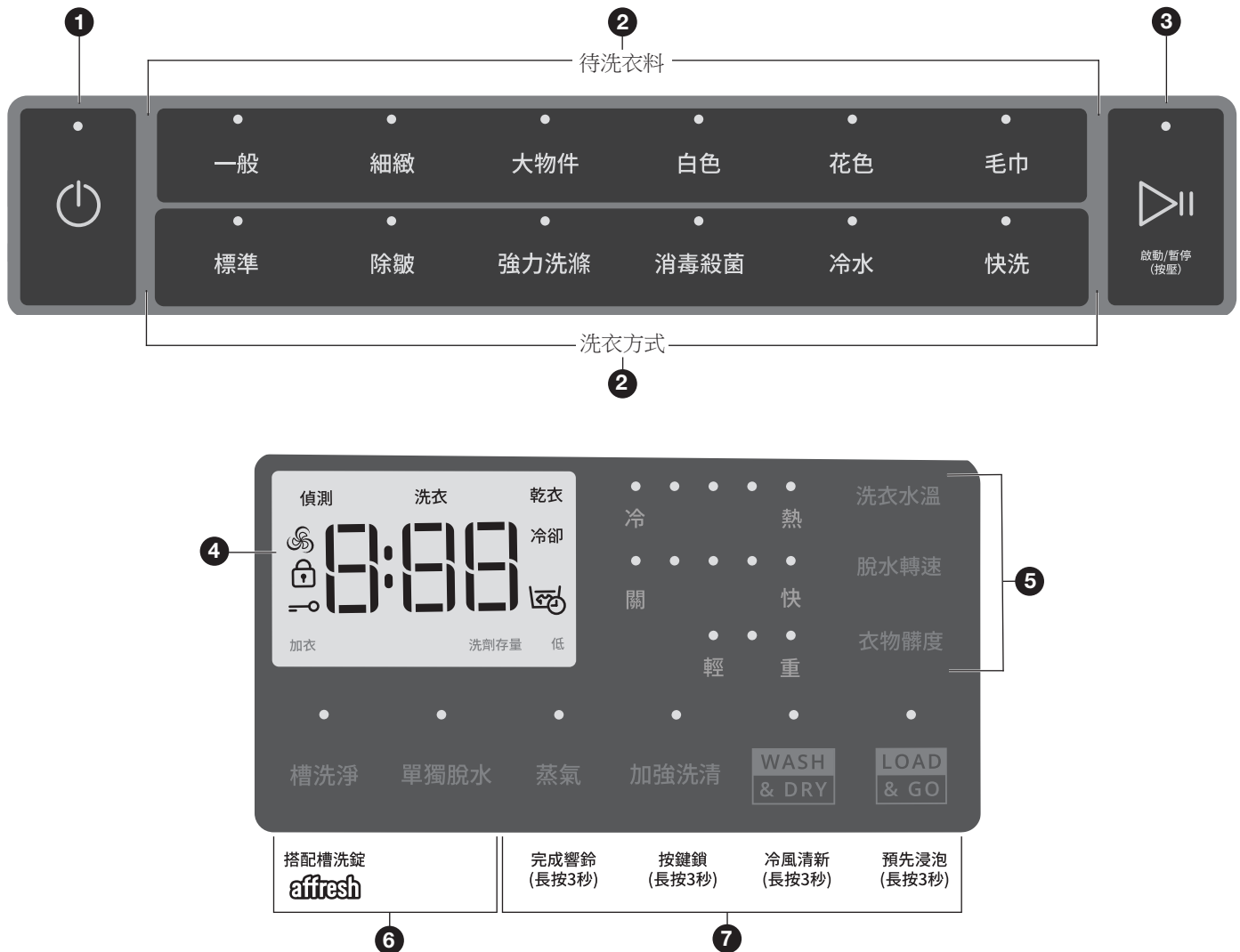

行程和設定視機種而有所不同。

## 1 電源

按下以啟動和關閉洗衣機。按下以隨時停止/取消行程。

## 2 待洗衣料/洗衣方式

首先確認您要清洗哪些衣物，按照衣物種類選擇對應的「待洗衣料」選項。接著按您的需求選擇「洗衣方式」。行程詳情請參閱「行程指南」。若您未選擇「洗衣方式」，洗衣機將自動作出建議，或使用上一次設定的「洗衣方式」行程。

## 3 啟動/暫停

持續按壓 3 秒，直到「啟動/暫停」上方的燈光顯示開始行程，或行程進行期間觸碰一次，暫停機器運行。

## 4 行程狀態顯示畫面

「行程狀態顯示畫面」顯示行程進度。您可能注意到流程每個階段都會發出與傳統洗衣機不同的聲音和暫停。

## 預計剩餘時間

「預計剩餘時間」顯示完成行程的所需時間。衣物量、調整選項、所選設定，以及水壓等因素都可能影響所需時間。衣物塞太滿、放置不平均或過多泡沫都可能讓洗衣機延長行程時間。

## 感應

觸碰「啟動/暫停」後，洗衣機將發出響聲，表示它正在啟動。滾筒將局部轉動。機門上鎖後會發出喀嗒聲。

門上鎖第二次後，洗衣機將開始轉動以感應衣物量。行程中將持續此感應流程。

感應衣物量後，將根據此重量顯示預計時間，並開始注水。您也許會聽到從洗劑盒添加洗衣劑至衣物中所產生的水流聲。實際行程時間也許會延長。然而，顯示畫面將持續顯示預計時間。

## 洗衣

洗衣行程期間，將顯示洗衣，讓您瞭解正在進行的行程。

### 預先浸泡

將顯示此符號，說明正在進行預先浸泡。



### 洗劑存量低

若洗劑智慧投放盒內的洗衣劑量低，顯示畫面將顯示洗劑存量低。

### 加衣

顯示「加衣」時，您可暫停洗衣機，開門並放進更多衣物。觸碰並按住「啟動/暫停」，再次啟動洗衣機。

### 機門上鎖

將顯示「機門上鎖」符號，說明門已上鎖，且若沒有先暫停或取消行程，將無法打開它。



### 按鍵鎖

顯示「按鍵鎖」符號時，將停用按鈕。觸碰並按住「加強洗清」3秒即可啟用按鈕。



### 自動清新除皺（部份機種）

此符號會在「自動清新除皺」選項啟用時顯示。衣物會定期翻滾，時間長達 12 小時。



### 自動冷風清新（部份機種）

啟動自動冷風清新選項後，將顯示此符號。風扇將打開，且衣物將定時滾動最長達 12 小時。



### 結束

完成行程後，將顯示「End」。立即取出衣物，取得最佳洗衣成果。

## 5 調整選項

選擇特定行程時，其預設設定將亮起。觸碰以調整洗衣機上的調整選項，再觸碰「啟動/暫停」。觸碰「啟動/暫停」後可能就無法啟動額外選擇的洗衣調整選項或設定。

調整好特定的洗衣行程設定後，將儲存為您自訂的行程設定。如果要返回原廠預設行程設定，拔下洗衣機插頭 30 秒，然後再插入插頭即可。預設行程設定請參閱「行程指南」。

**備註：**有些設定可能會增加或減少預計剩餘時間。

### 洗衣水溫

已預設每個行程的建議洗衣溫度。可變更部份預設溫度。您也可以根據髒汙程度和布料種類，選擇不同的洗衣溫度。為取得最佳成果，根據衣物標籤說明，使用對布料最安全 and 最溫暖的洗衣用水。所有洗衣溫度都帶有冷水洗清功能。

### 脫水轉速

已預設每個行程的建議脫水轉速。可變更部份預設速度。

- 轉速較快可縮短烘乾時間，但可能會讓衣物較皺。
- 轉速較慢減少衣物皺痕，但衣物會較濕。

### 衣物髒度

已預設每個行程的建議衣物髒度。可變更部份預設的衣物髒度。若是極為髒汙的堅固布料，「衣物髒度」請設定「重」。若為略髒的精緻布料，「衣物髒度」請設定「輕」。較輕的衣物髒度設定有助減少衣物纏繞和皺痕。

## 6 實用行程

### 槽洗淨

每 30 次洗衣後用此行程一次，保護洗衣機內部清新和清潔。此行程使用較高水位。搭配使用 affresh 槽洗錠或液態含氯漂白劑，徹底清潔洗衣機的內部。使用此行程時，滾筒內應無衣物。不得中斷此行程。請參閱「洗衣機保養」部份。

### 單獨脫水

本行程排除衣物或手洗的特別保養衣物之過多水份。電力中斷後請使用此行程。對於部份布料，可選擇設定較慢的轉速。

## 7 行程選項

可為每個行程新增或移除選項。並非所有行程都能使用所有選項，且部分預設之選項只能用於特定行程內。選項視機種而有所不同。

### 「蒸氣」（部份機種）

「蒸氣」選項在許多行程內增加額外的浸泡和洗衣時間，以清除頑強污漬，並驅動蒸氣，增加洗淨力。內建式加熱器維持最佳洗衣溫度。參閱「行程指南」，瞭解可進行「蒸氣」選項的行程。

也可觸碰並按住「蒸氣」3 秒，開啟或關閉「完成響鈴」。

### 加強洗清

啟動此選項，增加「加強洗清」於大部分之行程。

也可觸碰並按住「加強洗清」3 秒，停用/啟用「按鍵鎖」。

### Load & Go（部份機種）

若您希望在洗衣的適當時間自動加入 HE 高效能洗衣劑，觸碰以選擇此選項。

**重要事項：**使用已裝有濃縮洗衣精的洗劑盒時，若所用洗衣精的濃度和原廠預設的 2x 濃度不同，請變更控制鍵中的洗衣精濃度設定。觸碰並按住「洗衣水溫」和「衣物髒度」3 秒，變更洗衣精濃度設定。

也可觸碰並按住 LOAD & GO 3 秒，設定預先浸泡。

### 預先浸泡：

觸碰以便在洗衣行程中新增您選擇的預先浸泡時間。



## 8 洗劑盒

### Load & Go 洗劑智慧投放盒 (部份機種 - 視機種而有所不同)

「Load & Go 洗劑智慧投放盒」讓您無需每次洗衣都要添加 HE 高效能洗衣劑。它能決定最適當的洗衣劑用量，以及加進衣物中的最佳時間。參閱「使用洗劑盒」部份，瞭解使用洗劑盒的資訊。

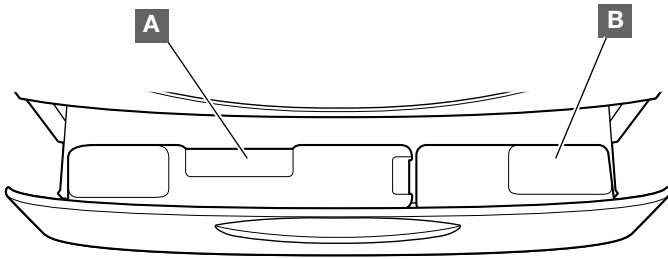

可選擇附帶 1 或 2 公升洗劑智慧投放盒的洗衣機。

### 單次衣物洗劑盒

單次衣物洗劑盒能讓您方便地在適當的時間內，添加 HE 高效能洗衣劑、液態含氯漂白劑和衣物柔軟劑至清洗衣物內。參閱「使用洗劑盒」部份，瞭解使用洗劑盒的資訊。

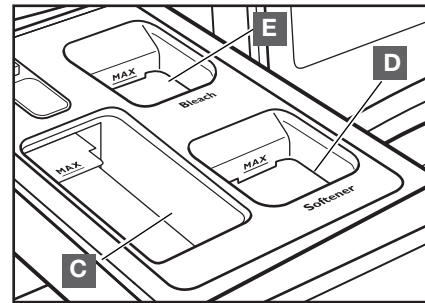

#### A 2 公升大型 HE 高效能洗衣劑的洗劑盒

此洗劑智慧投放盒能儲存高達 67.6 oz (2 公升) 的 HE 高效能洗衣劑。

#### B 1 公升大型 HE 高效能洗衣劑的洗劑盒

此洗劑智慧投放盒能儲存高達 33.8 oz (1 公升) 的 HE 高效能洗衣劑。

每個洗劑盒能放置可供數次洗衣的洗衣劑用量。每次洗衣都能在適當時間把適當的 HE 高效能洗衣劑用量加進衣物中。參閱「使用洗劑盒」，瞭解使用洗劑盒的資訊。

**重要事項：**請勿將含氯漂白水或洗衣粉倒入洗劑智慧投放盒。洗衣粉必須倒入單次衣物洗劑盒。請參閱「使用洗衣機」部份。

#### C HE 高效能洗衣劑放置格

本放置格能放置 HE 高效能洗衣劑或洗衣粉，供您主要洗衣行程之用，且能在行程間自動分配洗劑。

#### D 衣物柔軟劑放置格

本放置格放置衣物柔軟劑。它能在行程最佳時間點，自動分配衣物柔軟劑。

#### E 液態含氯漂白劑放置格

本放置格在洗衣行程後的第一次洗清時，於行程最佳時間點，自動稀釋和分配液態含氯漂白劑。它無法稀釋漂白粉。

## 行程指南

本洗衣機配備獨特的使用者介面，協助您為衣物選擇最佳行程。以下「待洗衣料」、「洗衣方式」表格指引您如何以兩個步驟選擇最佳行程：首先確認您正要清洗哪些衣物，按照衣物種類選擇對應的「待洗衣料」選項。接著按您的需求選擇「洗衣方式」，確認洗衣機應如何清洗衣物。選擇「待洗衣料」將自動選擇預設的「洗衣方式」，您可自行選擇是否調整「洗衣方式」。見下表瞭解更多詳情。

您想要清洗什麼？	「待洗衣料」行程選擇：
棉質、亞麻布和混合衣物	一般
免燙衣料、襯衫/褲子、合成纖維、薄紗/花邊衣物	細緻
大型衣物，例如：小棉被、睡袋、夾克和可洗地毯	大物件
白色布料/衣服	白色
亮色或深色棉質、亞麻和混合衣物	花色
布料堅固的毛巾和抹布	毛巾

想要如何清洗它們？	「洗衣方式」行程選擇：
一般	標準
少些皺痕	除皺
強力清潔	強力洗滌
排除 99.9% 的三種常見居家細菌	消毒殺菌（部分機種使用 Oxi 粉劑）*
冷水溫和清潔	冷水
快速	快洗

以**粗體字**顯示的設定和選項，是該洗衣行程的預設設定。為達成最佳布料維護目的，選擇最適用於需要清洗的衣物之行程、選項和設定。請務必閱讀和遵循布料保養標籤，以及清洗產品說明。避免把衣物塞太滿。洗衣機塞得太滿，就無法妥善將衣物洗淨或脫水。並非每個行程都提供所有設定，且部份選項無法合併使用。並非所有機種都提供所有選項。

待洗衣料	洗衣方式	基本設定			更多選項			
		洗衣水溫	脫水轉速	衣物髒度	蒸氣	加強洗滌	預先浸泡	Load & Go
一般	<b>標準</b>	熱 微熱 溫 涼 冷	高 中高 中 不脫水	輕 正常 重	✓	✓	✓	✓
	除皺	熱 微熱 溫 涼 冷	高 中高 中 慢 不脫水	輕 正常 重	✓	✓	✓	✓
	強力洗滌	熱 微熱 溫 涼 冷	高 中高 中 不脫水	輕 正常 重	✓	✓	✓	✓
	消毒殺菌 （部分機種使用 Oxi 粉劑）*	熱	高 中高 中	輕 正常 重	✓	✓		✓
	冷水	熱 微熱 溫 涼 冷	高 中高 中 不脫水	輕 正常 重		✓	✓	✓
	快洗	熱 微熱 溫 涼 冷	高 中高 中 不脫水	輕 正常 重	✓	✓	✓	✓

\*本行程去除衣服、床單和毛巾 99.99% 的大部份常見細菌。使用適用的最高洗衣水溫並添加 Oxi 粉劑至滾筒（部份機種），確保能進行消毒作業。檢查衣物的建議洗衣水溫並使用製造商建議的 Oxi 用量（部份機種）。經測試的細菌包括：克雷伯氏肺炎菌、銅綠假單胞菌和金黃色葡萄球菌。



待洗衣料	洗衣方式	基本設定			更多選項			
		洗衣水溫	脫水轉速	衣物髒度	蒸氣	加強洗滌	預先浸泡	Load & Go
細緻	標準	熱 微熱 溫 涼 冷	高 中 高 中 低 不脫水	輕 正 常 重	✓	✓	✓	✓
	快洗	熱 微熱 溫 涼 冷	高 中 高 中 低 不脫水	輕 正 常 重	✓	✓	✓	✓
	除皺	熱 微熱 溫 涼 冷	高 中 高 中 低 不脫水	輕 正 常 重	✓	✓	✓	✓
	強力洗滌	熱 微熱 溫 涼 冷	高 中 高 中 低 不脫水	輕 正 常 重	✓	✓	✓	✓
	冷水	熱 微熱 溫 涼 冷	高 中 高 中 低 不脫水	輕 正 常 重		✓	✓	✓
	消毒殺菌 (部分機種使 用 Oxi 粉劑)*	熱	高 中 高 中 等 低 不脫水	輕 正 常 重	✓	✓		✓
大物件	標準	熱 微熱 溫 涼 冷	高 中 高 中 低 不脫水	輕 正 常 重	✓	✓	✓	✓
	快洗	熱 微熱 溫 涼 冷	高 中 高 中 低 不脫水	輕 正 常 重	✓	✓	✓	✓
	除皺	熱 微熱 溫 涼 冷	高 中 高 中 等 低 不脫水	輕 正 常 重	✓	✓	✓	✓
	強力洗滌	熱 微熱 溫 涼 冷	高 中 高 中 低 不脫水	輕 正 常 重	✓	✓	✓	✓
	冷水	熱 微熱 溫 涼 冷	高 中 高 中 低 不脫水	輕 正 常 重		✓	✓	✓

\*本行程去除衣服、床單和毛巾 99.99% 的大部份常見細菌。使用適用的最高洗衣水溫並添加 Oxi 粉劑至滾筒（部份機種），確保能進行消毒作業。檢查衣物的建議洗衣水溫並使用製造商建議的 Oxi 用量（部份機種）。經測試的細菌包括：克雷伯氏肺炎菌、銅綠假單胞菌和金黃色葡萄球菌。

待洗衣料	洗衣方式	基本設定			更多選項			
		洗衣水溫	脫水轉速	衣物髒度	蒸氣	加強洗滌	預先浸泡	Load & Go
白色	標準	熱 微熱 溫 涼 冷	高 中 高 中 低 不脫水	輕 正 常 重	✓	✓	✓	✓
	快洗	熱 微熱 溫 涼 冷	高 中 高 中 低 不脫水	輕 正 常 重	✓	✓	✓	✓
	除皺	熱 微熱 溫 涼 冷	高 中 高 中 低 不脫水	輕 正 常 重	✓	✓	✓	✓
	強力洗滌	熱 微熱 溫 涼 冷	高 中 高 中 低 不脫水	輕 正 常 重	✓	✓	✓	✓
	冷水	熱 微熱 溫 涼 冷	高 中 高 中 低 不脫水	輕 正 常 重		✓	✓	✓
	消毒殺菌 (部分機種使 用 Oxi 粉劑)*	熱	高 中 高 中 低 不脫水	輕 正 常 重	✓	✓		✓
花色	標準	熱 微熱 溫 涼 冷	高 中 高 中 低 不脫水	輕 正 常 重	✓	✓	✓	✓
	快洗	熱 微熱 溫 涼 冷	高 中 高 中 低 不脫水	輕 正 常 重	✓	✓	✓	✓
	除皺	熱 微熱 溫 涼 冷	高 中 高 中 低 不脫水	輕 正 常 重	✓	✓	✓	✓
	強力洗滌	熱 微熱 溫 涼 冷	高 中 高 中 低 不脫水	輕 正 常 重	✓	✓	✓	✓
	冷水	熱 微熱 溫 涼 冷	高 中 高 中 低 不脫水	輕 正 常 重		✓	✓	✓
	消毒殺菌 (部分機種使 用 Oxi 粉劑)*	熱	高 中 高 中 低 不脫水	輕 正 常 重	✓	✓		✓

\*本行程去除衣服、床單和毛巾 99.99% 的大部份常見細菌。使用適用的最高洗衣水溫並添加 Oxi 粉劑至滾筒（部份機種），確保能進行消毒作業。檢查衣物的建議洗衣水溫並使用製造商建議的 Oxi 用量（部份機種）。經測試的細菌包括：克雷伯氏肺炎菌、銅綠假單胞菌和金黃色葡萄球菌。

待洗衣料	洗衣方式	基本設定			更多選項			
		洗衣水溫	脫水轉速	衣物髒度	蒸氣	加強洗滌	預先浸泡	Load & Go
毛巾	標準	熱 微熱 溫 涼 冷	高 中 高 中 低 不脫水	輕 正 常 重	✓	✓	✓	✓
	快洗	熱 微熱 溫 涼 冷	高 中 高 中 低 不脫水	輕 正 常 重	✓	✓	✓	✓
	除皺	熱 微熱 溫 涼 冷	高 中 高 中 低 不脫水	輕 正 常 重	✓	✓	✓	✓
	強力洗滌	熱 微熱 溫 涼 冷	高 中 高 中 低 不脫水	輕 正 常 重	✓	✓	✓	✓
	冷水	熱 微熱 溫 涼 冷	高 中 高 中 低 不脫水	輕 正 常 重		✓	✓	✓
	消毒殺菌 (部分機種使 用 Oxi 粉劑)*	熱	高 中 高 中 低 不脫水	輕 正 常 重	✓	✓		✓

\*本行程去除衣服、床單和毛巾 99.99% 的大部份常見細菌。使用適用的最高洗衣水溫並添加 Oxi 粉劑至滾筒（部份機種），確保能進行消毒作業。檢查衣物的建議洗衣水溫並使用製造商建議的 Oxi 用量（部份機種）。經測試的細菌包括：克雷伯氏肺炎菌、銅綠假單胞菌和金黃色葡萄球菌。

## 選擇正確的洗衣劑

僅可使用「高效能」洗衣劑。包裝上會標示「HE」或「高效能」。低水量洗衣時若使用非 HE 高效能洗衣劑，將產生多餘的泡沫。使用非 HE 高效能洗衣劑也可能導致較長的行程時間、降低洗淨效果。此舉也可能導致零件故障，而且長久下來可能導致積聚黴菌或發霉。HE 高效能洗衣劑泡沫不多、散佈快，能產生正確的泡沫量，並帶來最佳洗淨效果。此等洗衣劑能讓污垢懸浮，因此不會再度沉澱在乾淨的衣物上。並非所有標示為「高效能」的洗衣劑都內含相同配方，而減少泡沫的能力也有所不同。例如：天然、有機或自製 HE 高效能洗衣劑可能會產生大量泡沫。若您使用上述其中一種產品，並看到顯示畫面上出現「Sd」或「Sud」錯誤碼，考慮使用不同的 HE 高效能洗衣劑。請務必遵循洗衣劑製造商的說明，決定洗衣劑的用量。



僅使用 HE 高效能洗衣劑。

### 關於洗衣劑的濃度

市售液態 HE 高效能洗衣劑都是濃縮的。大部份 HE 高效能濃縮洗衣劑品牌都會在瓶子上顯示濃度。

然而，即使洗衣精瓶子未顯示濃度，也可輕易計算。只要將包裝之液體容量，除以可洗衣物的次數即可。再參照下表，尋找對應的濃度。

若洗淨效果不如預期，請試著使用較低的濃縮數。若產生過多泡沫，試著使用較高的濃縮數。

若洗衣精濃度並非 2x，請同時觸碰並按住「洗衣水溫」和「衣物髒度」3 秒，變更洗衣精濃度設定。

濃度	濃度盎司數 ÷ 衣物數
2X	1.5–2.49 (44.4 mL–73.6 mL)
3X	0.9–1.49 (26.6 mL–44.1 mL)
4X	0.7–0.89 (20.7 mL–26.3 mL)
5X	0.5–0.69 (14.8 mL–20.4 mL)
6X	0.3–0.49 (8.9 mL–14.5 mL)

## 使用洗劑盒（視機種而有所不同）

1. 針對自動分配功能，用洗衣機底部的把手，打開洗劑智慧投放盒。針對單次衣物，打開洗衣機左上角的單次衣物洗劑盒，並停用 Load & Go 選項。
2. 按下列說明添加洗劑。
3. 慢慢關上洗劑盒。確定已全部關閉盒子。

### 備註：

- 單次衣物洗劑盒也許會殘留之前洗衣行程的少量水。這是正常現象。
- 參閱「關於洗衣精的濃度」，瞭解洗衣精濃度的資訊。
- 針對部份機種：若洗劑智慧投放盒內的洗衣精量低，顯示畫面將顯示洗劑存量低。
- 放入衣物前，添加單次劑量和 Oxi 類型加強清潔劑至洗衣筒中。請參閱「使用洗衣機」部份。

## 添加 HE 高效能洗衣劑至洗劑盒

### Load & Go 洗劑智慧投放盒（部份機種）

僅可使用 HE 高效能洗衣劑。視洗劑盒，或是否足以清洗多批衣物而定，洗劑智慧投放盒能放置 67.6 oz (2 公升) 或 33.8 oz (1 公升) 的 HE 高效能洗衣劑。



僅使用 HE 高效能洗衣劑。

### 注滿洗劑智慧投放盒：

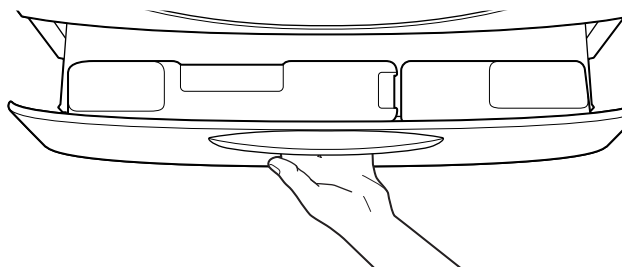

拉開洗衣機底部的把手，打開洗劑盒。可視需求從洗衣機取下整個洗劑盒。

找到 Load & Go 洗劑智慧投放盒。輕輕向上拉出位於洗劑智慧投放盒蓋上的突出物，抬起注液門。

添加 HE 高效能洗衣劑至「Max」線（參閱右方的插圖）。關上注液門。關門後會發出喀嗒聲。確定濃度正確（參閱「選擇正確的洗衣精」部份）。

更換洗衣精或長期不用洗衣機時，應沖洗洗劑盒。欲知清潔洗劑盒的說明，參閱「洗衣機保養」部份。

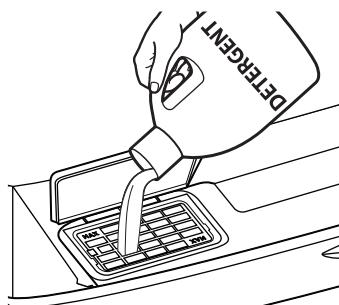
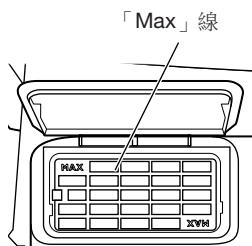
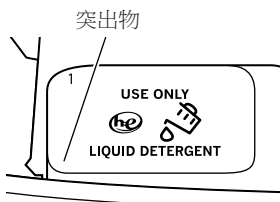

### 為單次衣物添加洗衣精

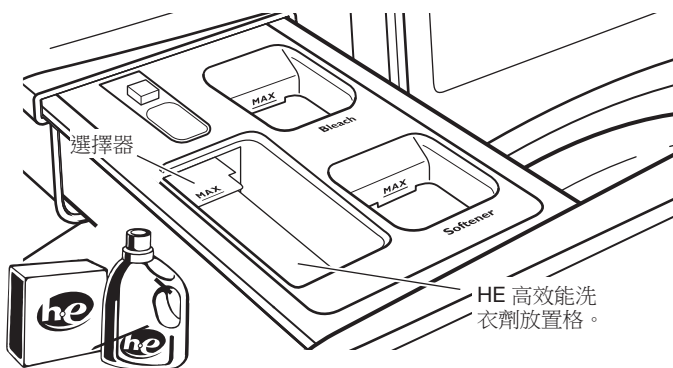

僅使用 HE 高效能洗衣劑。

直接將適量的 HE 高效能洗衣劑加入至洗衣精放置格內。若為洗衣粉，將選擇器升高至高位。若為洗衣劑，將選擇器推下至低位。

不要過度注入洗劑；添加太多洗衣劑可能讓它太早分配至洗衣機。

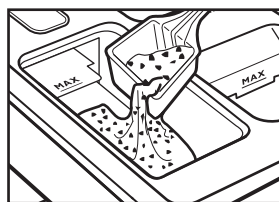

**洗衣粉：**  
將選擇器升高至高位。  
直接添加至放置格內。

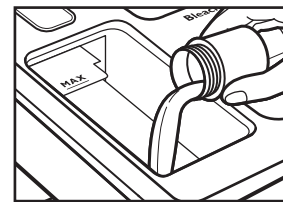

**洗衣劑：**  
將選擇器推下至低位。  
直接添加至放置格內。

### 重要事項：

- 開始單次洗衣前，請先停用 Load & Go 選項。
- 不要將洗衣膠囊加至洗劑盒。

# 使用洗衣機

## 警告



### 火災危險

請勿將沾過汽油或其他可燃液體的物品放進洗衣機。  
任何洗衣機都無法完全清潔油污。  
不得烘乾曾沾有任何油品的物品（包括烹調用油）。  
否則可能導致死亡、爆炸或失火。

## 警告



### 觸電危險

將插頭插入一個三孔的接地電源插座上。  
請勿拔掉接地插腳。  
請勿使用轉接頭。  
請勿使用延長線。  
違反這些指示可能導致人員傷亡、失火或觸電。

## 首先不放入衣物啟動洗衣行程

首次清洗衣物前，設定 Load & Go 洗劑智慧投放盒（部份機種），或在單次劑量洗劑盒內添加洗衣劑（參閱「使用洗劑盒」部份）。選擇「一般」（待洗衣料）和「快洗」（洗衣方式）行程，並在沒有衣物的情況下運行一次。僅使用 HE 高效能洗衣劑。此初次行程確保洗衣機內部清潔。

## 1. 分類和準備好您需要清洗的衣物

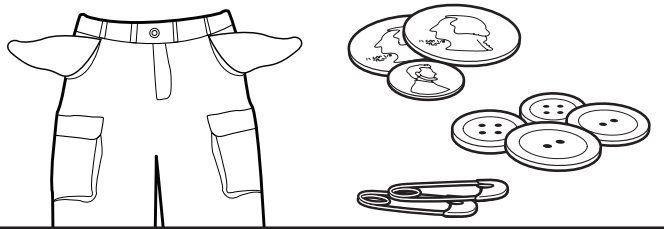

按建議行程、水溫和褪色程度分類衣物。請將嚴重髒汙和略髒衣物分開清洗。請將細緻衣物和堅固布料分開清洗。在衣物的內面測試去污產品，盡速處理污漬，並檢查褪色程度。

### 重要事項：

- 清空衣服的口袋。零錢、鈕釦或任何小物件都可能堵塞幫浦，以致於需要致電維修。
- 拉上衣服拉鍊、扣好鉤子、繫上繩子和腰帶，然後取下無法清洗的鑲邊和飾品。
- 縫補裂痕，避免洗衣時進一步損壞衣物。

- 針織品必須翻至反面，避免起毛球。請將易沾附棉絮的衣物與易產生棉絮的衣物分開清洗。合成纖維、針織品和燈芯絨會沾附來自毛巾、地毯和雪尼爾布料的棉絨。
- 洗衣後若仍殘留污漬，不得烘乾衣物，因為熱力可能將污漬永久留在衣物上。
- 請務必閱讀和遵循布料保養標籤，以及洗劑產品說明。不當洗衣可能損壞您的衣物。

## 2. （有需要時）放入洗衣用品

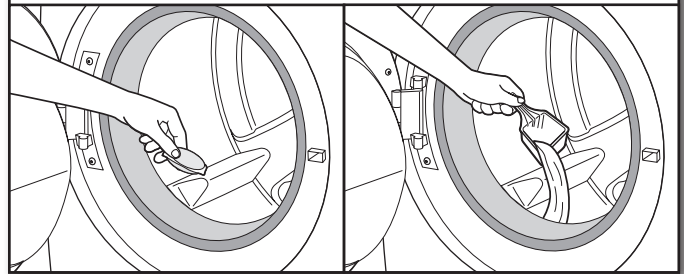

裝入衣物前可將洗衣膠囊、Oxi 類型加強清潔劑、護色漂白劑或香味晶球放入內桶。使用單次劑量洗衣膠囊時，確保已停用或關閉洗劑智慧投放盒（部份機種）（參閱「控制面板和功能」部份）。

**備註：**請務必遵循製造商的指示說明。

### 3. 將衣物放進洗衣機內

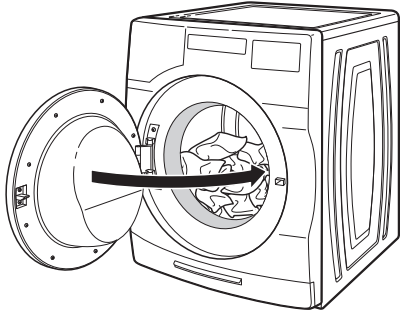

將整理好的衣物鬆散地放入洗衣機。衣物須能任意翻滾，才能取得最佳清潔效果，並避免衣物纏繞或產生皺痕。關閉機門時，請將機門向內推，直到聽到門鎖發出喀嗒聲。

- 請將衣物完全推入洗衣機，別讓橡膠圈上有任何衣物，以免卡在橡膠圈和機門玻璃之間。
- 混合大小衣物，避免清洗單件衣物。請平均放置衣物。
- 清洗小型衣物時，用網狀洗衣袋裝入衣物。若為多項衣物，使用多個袋子，並將衣物平均裝於袋內。

### 4. 添加 HE 高效能洗衣劑

Load & Go 洗劑智慧投放盒 (部份機種)

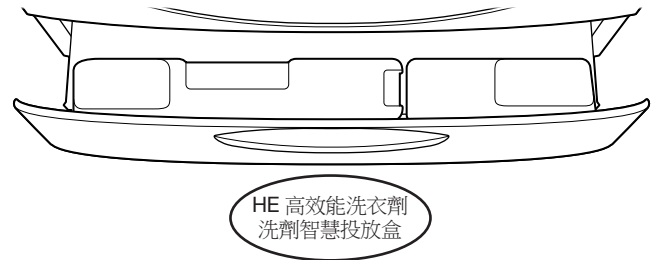

HE 高效能洗衣劑  
洗劑智慧投放盒

若洗劑智慧投放盒已有足夠的洗衣劑來洗衣，只需選擇步驟 10 說明的 Load & Go 選項。如需添加洗衣劑至洗劑智慧投放盒，參閱「使用洗劑盒」部份。

或

單次衣物洗劑盒

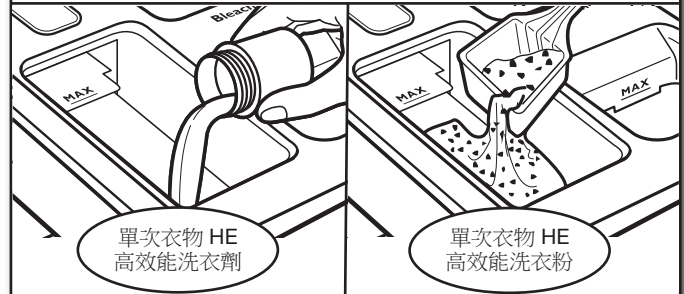

單次衣物 HE  
高效能洗衣劑

單次衣物 HE  
高效能洗衣粉

根據所用的 HE 高效能洗劑 (液體或粉末)，調整選擇器。直接將適量的洗衣劑加入至洗衣劑放置格內。請參閱「使用洗劑盒」部份。請停用 Load & Go 選項。

**備註：**請勿將洗衣膠囊、Oxi 類型加強清潔劑、護色漂白劑或香味晶球放入洗劑盒內。這些物品無法從洗劑盒內正確地加入清洗的衣物中。

## 5. 可將衣物柔軟劑放進單次衣物洗劑盒內 (若有需要)

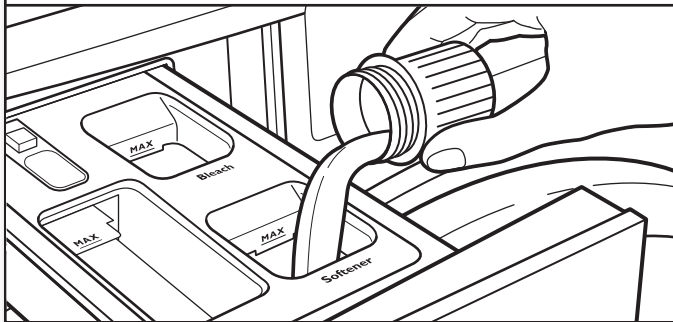

倒入定量的衣物柔軟劑至衣物柔軟劑放置格內。請務必遵循製造商的說明，根據您的衣物量，使用正確的柔軟劑用量。

即使已選擇「加強洗清」，衣物柔軟劑仍僅會在最後一次洗清時加入。

**重要事項：**不得過量添加、稀釋或使用超過製造商建議的柔軟劑用量。倒入柔軟劑時，不得超過格子內顯示的「Max」線。過量的柔軟劑將立即進入洗衣機內。

- 不得將柔軟劑噴濺或滴落至衣物上。
- 不得在本洗衣機內使用衣物柔軟劑輸送球。此物品無法正確分配。
- 不得使用衣物柔軟紙，因它可能會讓衣物染色。

## 6. 將液態含氯漂白劑注入單次衣物洗劑盒內 (若有需要)

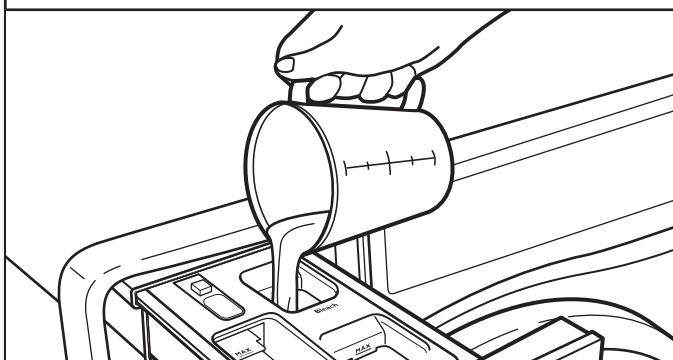

將液態含氯漂白劑加進漂白劑放置格內 (若有需要)。不得過量添加、稀釋或使用超過超過 2/3 杯 (165 mL)。使用液態含氯漂白劑的行程內，不得使用護色漂白劑或 Oxi。

**重要事項：**

- 請務必測量液態含氯漂白劑的用量，可利用有傾倒口的量杯計算，不要僅用目測。
- 不得注入超過格子內顯示的「Max」線。過量添加可能會損壞衣物
- 使用「槽洗淨」行程期間，不得使用增稠、易倒或不噴濺的漂白劑，因為此舉會產生過多泡沫。
- 針對部份機種：不得將液態含氯漂白劑加至洗劑智慧投放盒內。
- 慢慢關上洗劑盒。請確保洗劑盒已關緊。

## 7. 觸碰「電源」，啟動洗衣機



## 8. 選擇洗衣行程



首先請觸碰上方工具列中的選項，選擇待洗衣物。接著觸碰下方一排的選項，選擇洗衣方式，為衣物選擇最佳行程組合。欲知行程功能，請參閱「行程指南」。

## 9. (若有需要) 調整行程選項功能



LED 顯示幕將顯示所選行程的預設設定。要調整設定，請分別按壓「洗衣水溫」、「脫水轉速」、「衣物髒度」。調整設定可能會變更「預計剩餘時間」。衣物塞太滿、放置不平均或過多泡沫都可能讓洗衣機延長行程時間。

## 10. 選擇任何額外的選項\*

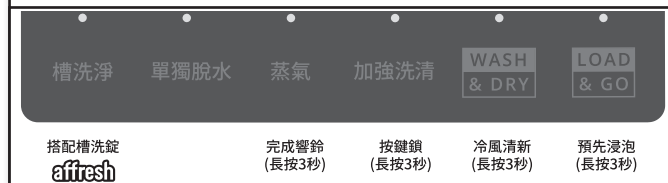

欲新增行程選項，請分別按壓「蒸氣」、「加強洗清」或「單獨脫水」。欲使用洗劑智慧投放盒 (部份機種)，選擇 Load & Go。至於其他選項，請持續按壓對應的按鈕 3 秒。欲從所選行程移除選項，請再次觸碰該按鈕。

\*並非所有行程都提供所有選項和設定。參閱「行程指南」，瞭解適用的選項和設定。

## 11. 觸碰並按住「啟動/暫停」，開始洗衣行程



觸碰並按住「啟動/暫停」3秒即可開始洗衣行程。如要暫停行程，請觸碰「啟動/暫停」一次，要繼續洗衣行程，請再觸碰並按住「啟動/暫停」。欲取消行程，觸碰並按住「電源」並運行「單獨脫水」，洗衣機會將水排出。

一旦觸碰並按住「啟動/暫停」，您將聽到機門上鎖的聲音。洗衣行程期間洗衣機門將上鎖。

### 解鎖機門以增加衣物：

如需開門增加一或兩件遺漏的衣物，可在「加衣」燈亮起時這樣做。可增加衣物的時間將按行程選擇和衣物量而有所不同。

觸碰「啟動/暫停」一次，當洗衣機停止運轉時，機門將解鎖。這可能需時數分鐘。接著關閉機門，然後再次觸碰並按住「啟動/暫停」，重新啟動行程。

### 「增加衣物」燈關閉後增加衣物：

取消目前行程。洗衣機會將水排出，需要重新選擇行程後再次啟動。

為達成最佳洗衣和節能效果，請在「加衣」燈亮起時再增加衣物。

### 添加衣物



## 12. 行程結束後立即取出衣物

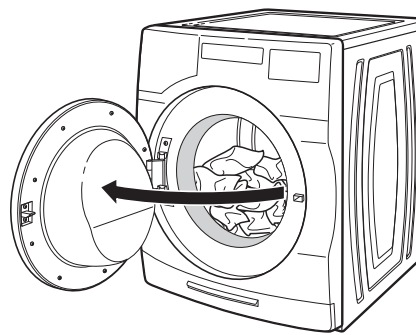

行程結束後立即取出衣物，避免氣味、金屬物品的鏽蝕殘留在衣物上。取出衣物時，應將門膠圈往後拉並檢查機門和洗衣機滾筒之間是否有小型物品。

若您無法即時取出衣物，使用冷風清新選項（若您的機種提供）。若選擇冷風清新選項，行程結束後洗衣機將自動啟動風扇，並於最長12小時內定時滾動衣物。

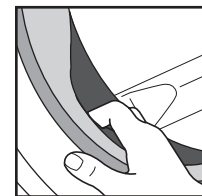

### 備註：

- 欲取消冷風清新選項，觸碰「電源」或「啟動/暫停」。
- 本洗衣機配備緊密封條，可避免滲水。為避免產生異味，使用後請讓機門打開，以便洗衣機能風乾。



# 洗衣機維護

## 進水管

使用洗衣機五年後請更換進水管，以降低水管損壞的風險。請定期檢查進水管，若發現突起物、打結、割痕、磨損或漏水的狀況，請更換進水管。

更換進水管時：

用不褪色麥克筆在標籤上標記更換日期。

檢查老舊洗衣機的進水閥有沒有堵塞。

新洗衣機應連接新進水管，請確保有妥善的密封。

## 洗衣機保養

### 維持洗衣機清潔和最佳效能的建議

1. 請務必使用高效能洗衣劑並遵循 HE 高效能洗衣劑製造商對 HE 高效能洗衣劑用量的說明。不得使用超過建議用量，因為此舉可能增加洗衣劑和污垢殘留積聚在洗衣機的速率，進而產生異味。
2. 偶爾要用溫水或熱水洗衣（不僅是只用冷水洗衣），因為溫水或熱水更能控制污垢和洗衣劑積聚的速率。
3. 洗衣機使用後略為開啟機門，有助於風乾洗衣機、避免能發出異味的殘留物積聚。
4. 定期清除機門窗戶整個內部表面的殘留物。若可以的話請用濕布擦拭機門的整個內部。

### 清潔您的滾筒洗衣機

展開下方建議的例行清潔流程前，請閱讀完整的說明。應最少每月執行本洗衣機維護程序一次，或 30 次洗衣行程後，須視何者先發生而定。此舉能控制污垢和洗衣劑積聚在洗衣機的速率。

#### 清潔門膠圈

1. 打開洗衣機門，取出所有衣物。
2. 檢查機門開口的灰色門膠圈以及洗衣筒是否有污漬、積聚污垢或棉絮。拉開門膠圈，檢查門膠圈下方所有區域，並檢查是否有異物或棉絮。
3. 若找到污漬、積聚污垢或棉絮之處，用下列程序之一，擦拭門膠圈區域：

#### a. affresh 機器清潔拭紙程序：

- i. 完成行程後，輕輕拉回橡膠的門膠圈，並用 affresh 機器清潔拭紙有紋路的一面清潔整個表面。

#### b. 稀釋液態含氯漂白劑程序：

- i. 混合稀釋的漂白劑：用 3/4 杯 (177 mL) 液態含氯漂白劑和 1 gallon (3.8 公升) 的溫熱自來水。
- ii. 用沾有稀釋溶劑的濕布擦拭門膠圈區域。
- iii. 靜置 5 分鐘。
- iv. 用乾布徹底清潔所有區域，並打開機門，風乾洗衣機內部。

## 洗衣機保養（續）

### 重要事項：

- 用漂白水清潔時要佩戴手套。
- 參考漂白水製造商的說明，正確使用產品。

### 清潔洗衣機內部

本洗衣機配備特殊行程，能結合「affresh 洗衣機清潔劑」或一般的液態含氯漂白劑，徹底清潔洗衣機的內部。蒸氣洗衣機機種也使用蒸氣，提升此特殊行程中的清潔力。

**重要事項：**使用「槽洗淨」行程期間，不得使用增稠、易倒或不噴濺的漂白劑，因為此舉會產生過多泡沫。

**備註：**展開清潔流程前，請閱讀完整的說明。

### 開始程序

#### 1. 「槽洗淨」（建議使用，因其能達成最佳效能）：

- a. 打開機門並取出所有衣物。
- b. 使用「affresh 機器清潔拭紙」或柔軟的濕布或海綿，擦拭機門窗戶。
- c. 放入「affresh 槽洗錠」至洗衣機滾筒內。
- d. 不得將「affresh 槽洗錠」加至洗劑盒內。
- e. 遵行本程序時，不得放入任何洗衣精或其他化學物至洗衣機內。
- f. 關閉洗衣機門。
- g. 選擇「槽洗淨」行程。
- h. 針對部份機種：選擇冷風清新選項，有助於完成行程後風乾洗衣機內部。

**備註：**洗衣機將儲存您上次的選項選擇，且在未來的洗衣行程中繼續使用，直到您取消選擇該選項。

- i. 觸碰並按住「啟動/暫停」，開始行程。「槽洗淨」行程說明如下。

#### 2. 含氯漂白劑程序：

- a. 打開機門並取出所有衣物。
- b. 打開單次衣物洗劑盒，放入常用的含氯漂白劑至漂白劑放置格和衣物柔軟劑放置格的「MAX」線。可使用傳統或 HE 高效能含氯漂白劑。

**重要事項：**不得使用增稠、易倒或不噴濺的漂白劑，因為會產生過多泡沫。

**備註：**使用比建議量更多的液態含氯漂白劑長期之後將損壞洗衣機。

- c. 關閉洗衣機門和洗劑盒。
- d. 遵行本程序時，不得加入任何洗衣精或其他化學物至洗衣機內。
- e. 選擇「槽洗淨」行程。
- f. 針對部份機種：選擇冷風清新選項，有助於完成行程後風乾洗衣機內部。  
**備註：**洗衣機會儲存您上次的選項選擇，且在未來的洗衣行程中繼續使用，直到您取消選擇該選項。
- g. 觸碰並按住「啟動/暫停」，開始洗衣行程。「槽洗淨」行程說明如下。

## 洗衣機保養（續上頁）

**備註：**為取得最佳成果，請勿中斷行程

### 「槽洗淨」行程的運行說明：

1. 「槽洗淨」行程自動偵測洗衣機內是否有任何衣物。
2. 若未偵測到衣物，將開始行程。
  - a. 若偵測到任何衣物，將顯示「rL」（取出衣物）。機門將解鎖。打開機門並取出洗衣筒內的所有衣物。
  - b. 觸碰「電源」，清除「rL」代碼。
  - c. 觸碰並按住「啟動/暫停」，重新開始洗衣行程。
3. **僅蒸氣機種：**在行程的前 20 分鐘，洗衣機將啟動蒸氣，但洗衣筒不會轉動或注水。在此初步階段您將看到機門窗戶上凝結的水滴。若您正在使用「affresh 槽洗錠」，它在蒸氣階段不會全部溶解。這是正常現象。

行程完成後，略為打開機門，讓空氣流通得更好，並風乾洗衣機內部。

### 清潔洗劑盒

使用「槽洗淨」行程一段時間後，您可能會發現洗衣機洗劑盒積聚殘留物。

欲清除洗劑盒的殘留物，取出洗劑盒並用「affresh 機器清潔拭紙」或濕布擦拭表面，並於運行「槽洗淨」行程之前或之後，用毛巾擦乾盒子。若有需要，使用全效表面清潔劑。

**針對部份機種：**欲清除 Load & Go 洗劑智慧投放盒的殘留物，拉起洗劑盒的把手，並從洗衣機櫥櫃中將它拉出，然後用流水徹底沖洗。用「affresh 機器清潔拭紙」或濕布擦拭洗劑盒的表面，再用毛巾擦乾盒子。若有需要，使用全效表面清潔劑。

把洗劑盒放回洗衣機櫥櫃，確保其已穩妥就定位。

**重要事項：**不得用洗碗機清潔洗劑盒。

### 清潔洗衣機外部

使用「affresh 機器清潔拭紙」或柔軟的濕布或海綿，擦拭任何溢出物。偶爾擦拭洗衣機外部，讓它看起來光潔如新。使用「affresh 機器清潔拭紙」或溫和的肥皂和水。

**重要事項：**為避免損壞洗衣機的烤漆，不得使用磨蝕性產品。

## 槽洗淨行程提醒

**備註：**並非所有「槽洗淨」行程都帶有提醒燈。

洗衣機運行 30 個洗衣行程後，洗衣行程結束後「槽洗淨」的 LED 燈將閃爍。這是提醒您需運行「槽洗淨」行程。

若未啟動「槽洗淨」行程，再完成 3 次正常洗衣行程後，LED 燈會在洗衣行程結束時停止閃爍。完成 30 次以上的洗衣行程後，「槽洗淨」LED 燈將於特定洗衣行程結束後再度閃爍，作為提醒。

## 取出洗劑盒（續上頁）

### 單次衣物洗劑盒

#### 取出洗劑盒

##### 拆卸方式：

1. 將洗劑盒向外拉出到底。
2. 按下釋放鍵，並把它拉出，以取出洗劑盒。

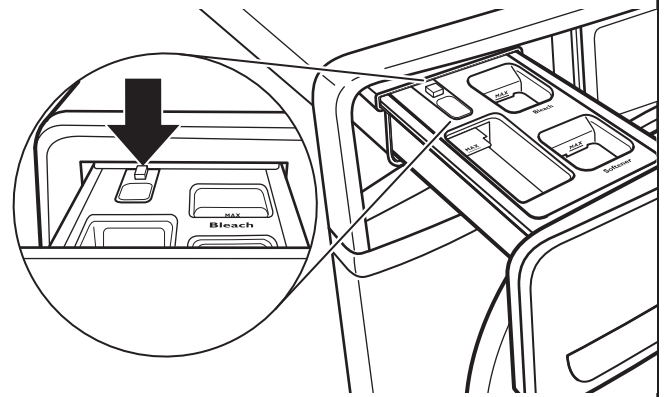

3. 直接向上拉起蓋子面板。

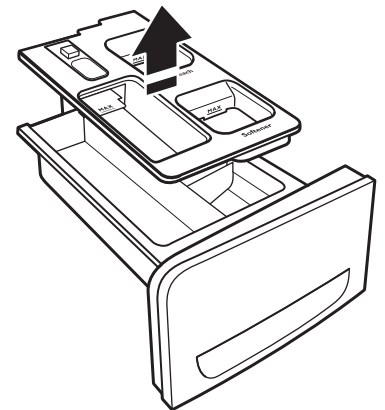

##### 裝回方式：

1. 把蓋子放回滑進洗劑盒的撐柱上。輕壓蓋子面板，使其穩妥就定位。
2. 將洗劑盒的邊緣對齊滑道，接著把洗劑盒滑進槽內。

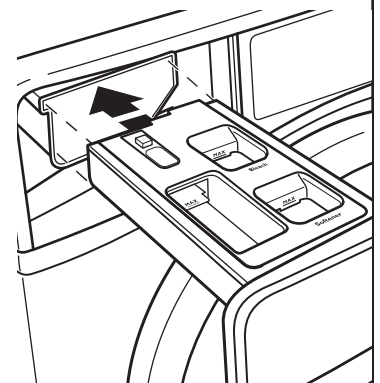

## 清潔 Load & Go 容器 (部份機種)

當您再加入洗劑、更換洗衣精類型或濃度，或長期不使用洗衣機時，請沖洗 Load & Go 容器。

1. 將洗劑盒向外拉出到底。
2. 拉出 Load & Go 容器。
3. 拉起注入蓋，用溫水徹底沖洗它。

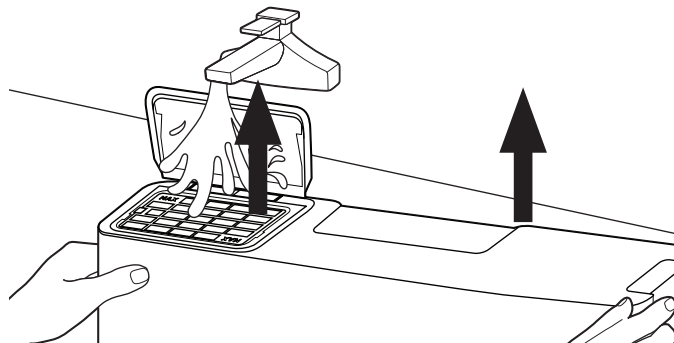

4. 最後放著風乾。

**重要事項：**不得用洗碗機清潔容器。

## 不再使用和度假保養

只可在您在家時運行洗衣機。若搬家，或將有一段時間不使用洗衣機，遵循下列步驟：

1. 拔下洗衣機電源，或切斷電源。
2. 關閉洗衣機水源，避免因水壓升高導致淹水。

**實用秘訣：**在洗衣機上標記提醒備註，下次使用洗衣機前要恢復供水。

3. 清潔洗劑盒。請參閱「清潔洗劑盒」。

## 冬季儲存保養

**重要事項：**為避免毀損，請將洗衣機安裝並存放在不會結冰的地方。由於管內可能殘存水份，水結冰後可能會損壞洗衣機。若在寒冷天氣下存放或搬運洗衣機，請做好防凍措施。

**洗衣機的防凍措施：**

1. 關閉冷熱水龍頭，接著拆下進水管並進行排水。

**實用秘訣：**在洗衣機上標記提醒備註，下次使用洗衣機前要恢復供水。

2. 放 1 qt (1 公升) 的 R.V. 防凍劑至洗衣機滾筒內，以標準行程運行洗衣機約 2 分鐘，混合防凍劑和殘留水份。
3. 拔下洗衣機的插頭，或切斷電源。

## 運送洗衣機

1. 關閉兩個水龍頭。拆下進水管並進行排水。
2. 若需在寒冷的天氣下搬運洗衣機，執行作業前請遵循「冬季儲存保養」說明。
3. 從排水系統和洗衣機背面拆下排水管。
4. 拔下電源線插頭。
5. 把進水管和排水管放在洗衣機滾筒內。
6. 用橡皮筋或纜線紮帶紮緊電線，避免它們懸吊至地面。

**重要事項：**致電維修部安裝全新的運送螺栓。不得重複使用運送螺栓。必須以直立的方式搬運洗衣機。為避免洗衣機的結構毀損，搬運和設定洗衣機的作業，必須由認證技工妥善執行。

## 警告



### 觸電危險

將插頭插入一個三孔的接地電源插座上。

請勿拔掉接地插腳。

請勿使用轉接頭。

請勿使用延長線。

違反這些指示可能導致人員傷亡、失火或觸電。

## 重新安裝/再使用洗衣機

在長期未用、度假、冬季儲存或搬遷後重新安裝洗衣機：

1. 參閱「安裝說明」，尋找洗衣機的安裝位置、平放和連接洗衣機。
2. 再次使用洗衣機前，遵行建議程序，運行洗衣機：  
**再次使用洗衣機：**
  1. 沖洗進水管。重新連接進水管。開啟冷熱水水龍頭。
  2. 插上洗衣機插頭，或重新連接電源。
  3. 用「強力洗滌」行程運行洗衣機，以清潔洗衣機及清除防凍劑。僅可使用 HE 高效能洗衣劑。使用廠商建議中量衣物所用劑量的一半。

## 警告



### 觸電危險

清潔家電前請務必切斷電源。

操作前請裝回所有零件和面板。

未拔下插頭可能導致人員傷亡或觸電。

## 清潔排水幫浦過濾器/排出殘留水份 (部份機種)

備註：偶爾執行下列程序。

1. 拉開洗衣機/乾衣機底部的把手，打開洗劑盒。您將看到排水幫浦過濾器。鬆開兩邊的釋放鍵，取出洗劑盒。

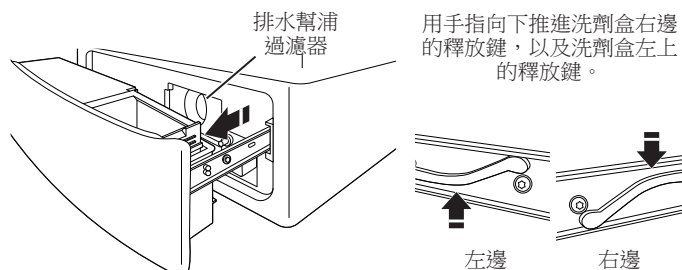

2. 放一個平寬的容器在排水幫浦過濾器下方，收集排水。鬆開管夾的黑色管子，取下插頭並排出管內水份至容器。倒空容器內的水份。若有必要，重複此程序，直到排除所有水份。確定黑色管子已完全乾燥，裝回插頭並連接管子和夾子。

備註：若無法妥善排水，稍微推進管子，清除任何可能的扭曲處。

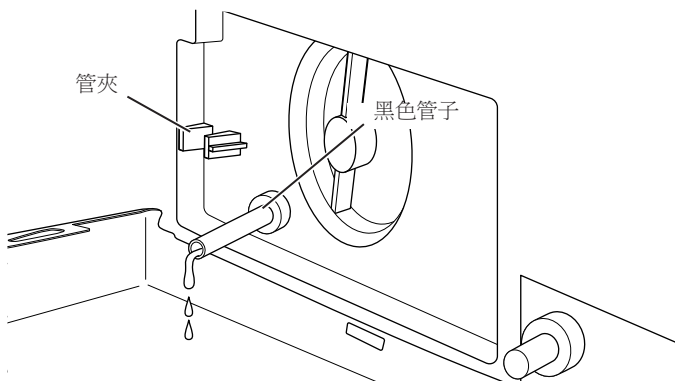

3. 放一塊棉布在排水幫浦過濾器下方，吸收任何仍在其內的水份。接著以順時針方向轉動排水幫浦過濾器，以便把它取下。

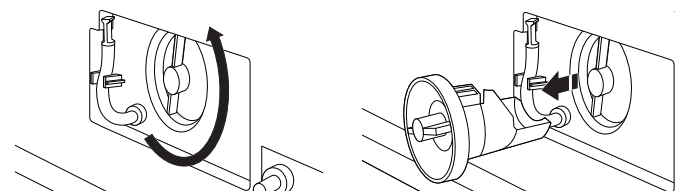

## 清潔排水幫浦過濾器/排出殘留水份 (續)

4. 用手從過濾器取出大堆棉絮，並把棉絮放在適當的廢棄物容器內。用水沖洗並清除過濾器內其餘的殘留物。

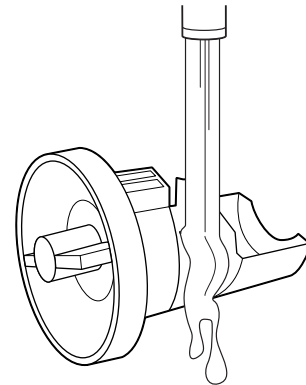

5. 順時針方向旋轉排水幫浦過濾器，重新把它接上。確定拴緊它，而過濾器把手儘量處於垂直位置。

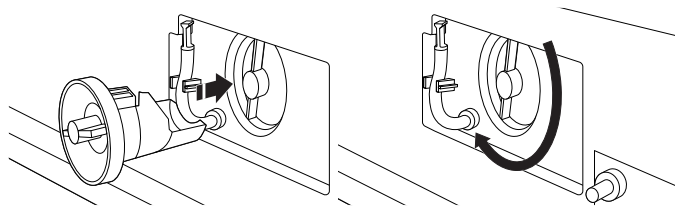

6. 裝回並關上洗劑盒。裝回洗劑盒時，確定已同步插入至兩條軌道。您將聽到喀嗒聲，說明已妥善插入至兩條軌道。為確保正確擺放洗劑盒，完全把它拉出。洗劑盒應能全部拉出，惟仍被軌道鎖住。確定排水管已連接管夾，且處於切口下方。

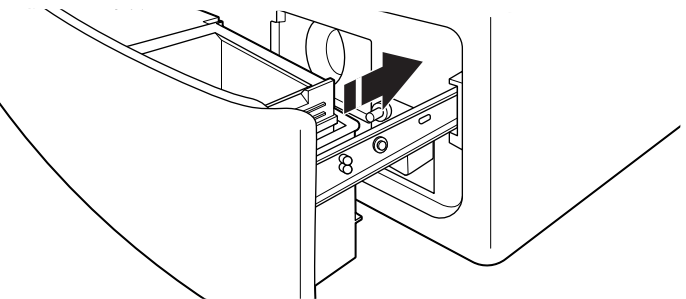

## 更多清潔作業

輕輕拉開橡膠的機門封條，並用「affresh 機器清潔拭紙」有紋路的一面清潔任何有污漬、積聚污垢或棉絮之處。

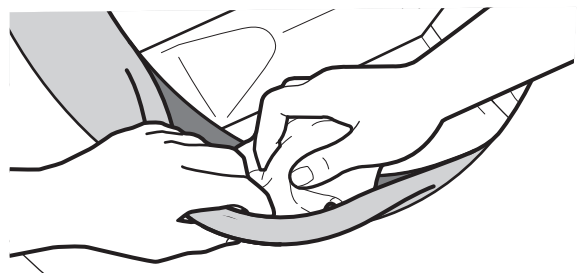

# 故障排除

首先，請嘗試此處的建議辦法，或造訪我們的網站：[www.whirlpool.com.tw](http://www.whirlpool.com.tw)。

如果您經歷了	可能原因	解決方案
<b>顯示畫面中顯示錯誤代碼（顯示 2 和 3 位數）</b>		
一旦修正所有可能問題後，觸碰「電源」一次，清除所有代碼。重新選擇和重新啟動行程。		
顯示畫面出現「Sd」或「Sud」（過多泡沫）	洗衣機有過多泡沫。洗衣機正在運行減少泡沫的例行作業。	允許洗衣機繼續運行。僅使用 HE 高效能洗衣劑。請務必遵循洗衣劑製造商的說明，並根據衣物量，決定洗衣劑的用量。並非所有標示為「高效能」的洗衣劑都內含相同配方，而減少泡沫的能力也有所不同。例如：天然、有機或自製 HE 高效能洗衣劑可能會產生大量泡沫。若您使用上述其中一種產品，並看到顯示畫面上出現「Sd」或「Sud」錯誤碼，考慮使用不同的 HE 高效能洗衣劑。
顯示畫面顯示 Lo 後再顯示 FL 或 F8 後再顯示 E1 或 Lo 後再顯示 FL 或 F08 後再顯示 E01（供水錯誤）	檢查供水是否正常。	機門上鎖時機體將排水 8 分鐘。必須讓排水行程完成，否則錯誤代碼無法重設。完成後，觸碰「電源」一次，清除代碼。接著再觸碰「電源」，重新啟動洗衣機。若再次顯示代碼，致電維修部。
		兩個進水管都必須接上，且水應流進進水閥。
		冷熱水龍頭都必須「開啟」。
		也許洗衣機的進水閥網罩堵塞。
		清除進水管任何扭曲處。
若有使用，自動關閉連接器和管子都必須妥善安裝。		
檢查進水管是否妥善。	僅使用製造商建議的進水管。	
顯示畫面顯示 F9 後再顯示 E1 或 F09 後再顯示 E01（排水幫浦系統錯誤）	檢查管線，確定已正確安裝排水管。排水管應延伸至立管的 4½" (114 mm) 處。	檢查已正確安裝排水管。
		確定排水管沒有糾結、刺穿或堵塞。
		取出管內任何堵塞物。
		使用排水管固定架，並穩妥連接至漏盆或水槽。
		若排水管末端離地面有 96" (2.4 m)，降低排水管的高度。
未使用 HE 高效能洗衣劑，或使用太多 HE 高效能洗衣劑。	僅使用 HE 高效能洗衣劑。請務必測量洗衣劑用量，並根據衣物量和髒汙程度，遵循製造商的用量說明。	
顯示畫面顯示 F5 後再顯示 E2 或 F05 後再顯示 E02（機門無法上鎖）	洗衣機門無法上鎖。	觸碰「電源」，取消行程。檢查機門已完全關閉且已拴上。請確認是否有衣物堵住機門，導致無法關門。

# 故障排除

首先，請嘗試此處的建議辦法，或造訪我們的網站：[www.whirlpool.com.tw](http://www.whirlpool.com.tw)

如果您經歷了	可能原因	解決方案
顯示畫面中顯示錯誤代碼（顯示 2 和 3 位數）（續上頁）		
顯示畫面出現「rL」（取出衣物）	「槽洗淨」行程時偵測到滾筒內有衣物。	取出滾筒的衣物，然後重新啟動「槽洗淨」行程。

警告

觸電危險

將插頭插入一個三孔的接地電源插座上。

請勿拔掉接地插腳。

請勿使用轉接頭。

請勿使用延長線。

違反這些指示可能導致人員傷亡、失火或觸電。

顯示畫面顯示除上述外的 F# E# 或 F## E## 代碼	系統錯誤代碼。	觸碰「電源」一次，清除代碼。接著再觸碰「電源」，重新啟動洗衣機。若再次顯示代碼，致電維修部。拔下洗衣機插頭 30 秒，然後再插上插頭。
洗衣機發出錯誤嗶聲	未打開和關閉機門最少三個行程。	此代碼可能在首次啟動洗衣機時出現。開啟和關閉機門，清除顯示。
觸碰「啟動/暫停」時，洗衣機會發出嗶聲。	洗衣機門關不緊。	完全關上洗衣機門。
「槽洗淨」LED 燈在洗衣行程結束後閃爍（部份機種）	洗衣機已運行了 30 次洗衣行程，提醒您要運行「槽洗淨」行程。	運行「槽洗淨」行程。若未啟動「槽洗淨」行程，運行 3 次或以上的正常洗衣行程後，洗衣行程結束後，LED 燈將停止閃爍。完成 30 次以上的洗衣行程後，「槽洗淨」LED 燈將於特定洗衣行程結束後再度閃爍，作為提醒。

# 故障排除

首先，請嘗試此處的建議辦法，或造訪我們的網站：[www.whirlpool.com.tw](http://www.whirlpool.com.tw)

如果您經歷了	可能原因	解決方案
<b>震動或不平衡</b>		
震動、搖晃或「前進後退」	支腳可能未和地板接觸且鎖死。	前腳和後腳必須穩妥與地板接觸，且洗衣機必須平放，才能正常運行。必須把鎖緊螺母牢牢拴緊在洗衣機底部。
	洗衣機也許未平放。	檢查地板是否彎曲或下沉。若地板不平，放一塊 3/4" (19 mm) 夾板在洗衣機底部，可減少噪音。不得將洗衣機安裝在架高的木平台上。 參閱「安裝說明」的「平放洗衣機」。
	衣物可能放置不均或太大件。	避免把衣物塞太滿。避免清洗單一衣物。用額外幾種衣物平衡類似地毯或牛仔夾克之類的單一衣物。 衣物不適用所選行程。參閱「行程指南」和「使用洗衣機」。
	運送螺栓也許還在洗衣機的背面。	參閱「安裝說明」的「取下洗衣機上的運送螺栓」。
<b>噪音</b>		
喀嗒或金屬噪音	機門上鎖或解鎖。	開始某個行程後滾筒將局部轉動，且機門會上鎖。行程結束前機門都將上鎖。這是正常現象。
	洗衣機排水系統內有物件。	洗衣前清空口袋。零錢之類的零散物品可能掉落至洗衣機滾筒和水槽之間，進而堵住幫浦。也許需要致電維修部清除物品。 聽到衣物金屬物品，例如：金屬按扣、搭扣或拉鍊與不鏽鋼滾筒接觸後發出聲音是正常現象。
淙淙聲或嗡嗡聲	洗衣機也許正在排水。	幫浦也許會發出嗡嗡聲，並偶爾發出淙淙聲或在轉動/排水行程排去最後水量時發出沖水聲。這在行程特定階段是正常現象。
滾動或晃動，並偶爾發出喀嗒聲（在低速轉動時）	平衡系統的鋼珠正在平衡衣物。	這在行程特定階段是正常現象。
<b>漏水</b>		
檢查已遵循正確的排水管安裝說明。	未緊密連接注水管。	拴緊注水管的連接處。
	注水管的墊圈。	穩妥拴緊所有四個注水管的扁平墊圈。
	排水管連接。	檢查已妥善連接排水管至漏盆或水槽。
	針對部份機種：未妥善安裝排水幫浦過濾器。	針對部份機種：確定已把過濾器放在幫浦的正確位置。參閱「清潔排水幫浦過濾器/排出殘留水份」。
	檢查家用管線是否有洩漏、堵塞或漏水。	水流可能會因為水槽或漏盆堵塞而回流。檢查所有家用管線是否有洩漏（水槽、漏盆和水龍頭）。
	排水管末端的固定接頭（或尼龍網）也許堵塞。	取下排水管的固定接頭/網子。

# 故障排除

首先，請嘗試此處的建議辦法，或造訪我們的網站：[www.whirlpool.com.tw](http://www.whirlpool.com.tw)

如果您經歷了	可能原因	解決方案
<b>漏水（續上頁）</b>		
機門或櫥櫃後方漏水或滲出泡沫	未使用 HE 高效能洗衣劑，或使用太多 HE 高效能洗衣劑。	僅使用 HE 高效能洗衣劑。一般洗衣劑產生的過多泡沫可能導致從機門或櫥櫃後方洩漏。請務必測量洗衣劑用量，並根據衣物量要求，遵循製造商的用量說明。
	運行「槽洗淨」行程時使用增稠、易倒或不噴濺的漂白劑。	運行「槽洗淨」行程時使用「affresh 槽洗錠」或一般的不增稠漂白劑。
	機門玻璃上有殘留物。	偶爾清潔窗戶下側，避免潛在的洩漏問題。
	「增加衣物」時打開了機門。	行程開始後開門，導致水從門內滴落。
機門四周漏水。	內門窗戶沾有頭髮、棉絮或其他殘留物，以致於門膠圈無法密合。	清潔內門窗戶和門膠圈。參閱「洗衣機維護」部份的「清潔門膠圈」。
<b>洗衣機未如預期的妥善運行</b>		
衣物未全部浸泡於水中	機門看不到水位，或水位未超過全部衣物。	這是 HE 滾筒式洗衣機的正常現象。洗衣機感應到衣物量，並注入正確的水量，以達成最佳清潔效果。
洗衣機未運行或注水；洗衣機停止運作	檢查妥善的水源。	兩個進水管都必須接上，且水應流進進水閥。
		冷熱水水龍頭都必須開啟。
		檢查進水閥網罩沒有堵塞。
		檢查進水管任何扭曲處，此現象可能限制水流。



**警告**



### 觸電危險

將插頭插入一個三孔的接地電源插座上。  
請勿拔掉接地插腳。  
請勿使用轉接頭。  
請勿使用延長線。  
違反這些指示可能導致人員傷亡、失火或觸電。

洗衣機未運行或注水；洗衣機停止運作（續）	檢查正常的電源供應。	將電源線插入一個 3 孔的接地電源插座上。
		請勿使用延長線。
		確保插座有電源。
		不得插入至 GFCI（接地故障斷路器）。
		檢查電源，或致電電工，檢查電壓是否過低。
		重設跳閘的斷路器。更換任何燒壞的保險絲。 <b>備註：</b> 若問題持續，聯絡電子技工。



# 故障排除

首先，請嘗試此處的建議辦法，或造訪我們的網站：[www.whirlpool.com.tw](http://www.whirlpool.com.tw)

如果您經歷了	可能原因	解決方案
<b>洗衣機未如預期的妥善運行 (續上頁)</b>		
洗衣機未運行或注水；洗衣機停止運作 (續上頁)	正在感應衣物量。	感應衣物量後，將根據此重量顯示預計時間。
	正常的洗衣機運作。	機門必須全部關閉並上栓，洗衣機才能運行。
		洗衣機於特定行程期間將暫停約 2 分鐘。請讓行程繼續。有些行程會有滾動和浸泡階段。
		洗衣機也許會停止，以減少泡沫。僅使用適量的 HE 高效能洗衣劑。
		「冷水」於行程開始時會用略少的水，以提供高濃度的洗衣劑，進行優化的清潔行動。以此濃度滾動後，會用較多的水來完成清洗。
		在「槽洗淨」行程的前 20 分鐘，洗衣機將啟動蒸氣，但滾筒不會轉動或注水。在此初步階段您將看到機門窗戶上的水滴。若您正在使用「槽洗錠」，它在蒸氣階段不會全部溶解。這是正常現象。
	洗衣機門沒有關緊。	洗衣機運行期間機門必須關閉。
	針對部份機種：Load & Go 洗劑智慧投放盒未穩妥放在洗衣機內。	確定 Load & Go 洗劑智慧投放盒已穩妥放在洗衣機內，且已緊密關閉洗劑智慧投放盒的蓋子。
	未按建議將衣物放入洗衣機內。	取出數件衣物，再於洗衣筒內平均放置衣物。關門，然後觸碰並按住「啟動/暫停」。
		行程開始後不要放入超過一或兩件衣物，避免把洗衣機塞滿或衣物放置不平均。
不要加水至洗衣機。		
未使用 HE 高效能洗衣劑，或使用太多 HE 高效能洗衣劑。	僅使用 HE 高效能洗衣劑。一般洗衣劑起的泡沫可能會減緩或停止洗衣機運行。請務必測量洗衣劑用量，並根據衣物量要求，遵循製造商的用量說明。	
	要清除泡沫，請取消行程。選擇「單獨脫水」與「加強洗清」。觸碰「啟動/暫停」。請勿加入更多洗衣劑。	
	若使用單次劑量洗衣精，請確認已停用 Load & Go。	
兩行程之間沒有把門打開。	完成任何洗衣行程後，必須開門，然後在開始新行程時，再關門。	
洗衣機沒有排水/轉動；衣物仍濕	排水管應延伸至立管的 4.5" (114 mm) 處。	檢查已正確安裝排水管。使用排水管固定架，並穩妥連接至漏盆或水槽。不要用膠帶黏住排水管的開口。
	排水管堵塞或排水管末端的高度離地面超過 96" (2.4 m)。	若排水管末端離地面有 96" (2.4 m)，降低排水管的高度。取出管內任何堵塞物。請參閱「安裝說明」中的「安裝要求」。
	排水管末端的固定接頭/網子堵塞。	取下排水管的固定接頭/網子。
	排水管在立管內擠壓的太緊，或是用膠帶黏在立管上。	排水管應鬆鬆，且穩妥與立管接合。不得用膠帶黏住排水管。水管需要透氣縫隙。參閱「安裝說明」的「連接排水管」。

## 故障排除

首先，請嘗試此處的建議辦法，或造訪我們的網站：[www.whirlpool.com.tw](http://www.whirlpool.com.tw)

如果您經歷了	可能原因	解決方案
<b>洗衣機未如預期的妥善運行（續上頁）</b>		
洗衣機沒有排水/轉動；衣物仍濕（續上頁）	使用轉速較慢的行程。	轉速較慢行程比轉速較快行程的去水力低。針對您的衣物選擇建議的行程/轉速。
	未按建議將衣物放入洗衣機內。	塞太滿或未平均放置的衣物也許無法讓洗衣機正確轉動，因此衣物比正常狀況殘留更多水分。欲知每個行程的更多資訊，請參閱「行程指南」。
	衣物也許放置得不平均。	避免清洗單一衣物。用額外幾種衣物平衡類似地毯或牛仔夾克之類的單一衣物。
	未使用 HE 高效能洗衣劑，或使用太多 HE 高效能洗衣劑。	僅使用 HE 高效能洗衣劑。一般洗衣劑起的過量，或使用太多洗衣劑，可能會減緩或停止洗衣機排水或轉動。請務必測量洗衣劑用量，並根據衣物量要求，遵循製造商的用量說明。欲清除過多泡沫，選擇「單獨脫水」與「加強洗清」。請勿加入更多洗衣劑。
	有些小物品可能會掉落至幫浦，或堵在洗衣機滾筒和外槽之間。	檢查滾筒，是否有物品卡在桶槽孔洞中。請清空衣物的口袋。若清洗小物品，請使用洗衣袋。
	針對部份機種：排水幫浦過濾器過髒。	針對部份機種：清潔排水幫浦過濾器。參閱「清潔排水幫浦過濾器/排出殘留水份」。
	已取消洗衣行程，且在排水前打開機門。	運行「單獨脫水」，清除任何過多水份。
洗衣機在沒有水的情況下空轉衣物。	洗衣機正在測量乾燥衣物的體積。	測量是正常作業，確保為衣物設定最佳行程時間。
洗衣行程結束後門上鎖。	洗衣行程結束後洗衣機仍殘留水份。	選擇「單獨脫水」，排去殘留在洗衣機內的任何水份。排水結束後洗衣機門將解鎖。
機門不會解鎖。	機門將於行程開始時上鎖。	若「加衣」燈亮起，觸碰「啟動/暫停」一次。機門將解鎖。
洗衣或洗清溫度不正確或錯誤	檢查妥善的水源。	確保沒有錯誤連接冷熱水進水管。
		兩條管子都必須連接至洗衣機和水龍頭，且都有冷熱水流進進水閥。
		檢查進水閥網罩沒有堵塞。
	清除管子內任何扭曲處。	
	清洗過多衣物。	您的熱水槽也許沒有足夠的熱水，來供應熱水或暖水洗衣的次數。這是正常現象。
想要的設定或選項沒有亮起。	為達成最佳效果，並非每個行程都提供所有設定，且部份選項無法合併使用。	參閱「行程指南」，瞭解每個行程的適用設定和選項。
未洗清衣物	檢查妥善的水源。	確保沒有錯誤連接冷熱水進水管。
		兩個進水管都必須接上，且水應流進進水閥。
		冷熱水水龍頭都必須「開啟」。
		也許洗衣機的進水閥網罩堵塞。
		清除進水管任何扭曲處。
	未使用 HE 高效能洗衣劑，或使用太多 HE 高效能洗衣劑。	來自非 HE 高效能洗衣劑的泡沫可能讓洗衣機未正確運行。 僅使用 HE 高效能洗衣劑。請務必測量洗衣劑用量，並根據衣物量和髒汙程度，遵循製造商的用量說明。

# 故障排除

首先，請嘗試此處的建議辦法，或造訪我們的網站：[www.whirlpool.com.tw](http://www.whirlpool.com.tw)

如果您經歷了	可能原因	解決方案
<b>洗衣機未如預期的妥善運行 (續上頁)</b>		
未洗清衣物 (續上頁)	未按建議將衣物放入洗衣機內。	避免把衣物塞太滿。洗衣機塞得太滿，就無法妥善洗清衣物。僅放入乾燥衣物。參閱「行程指南」，瞭解每個行程的建議衣物量。 使用待洗衣料專用的行程。 洗衣機啟動後僅放入一或兩件衣物。
	衣物也許放置得不平均。	若未平均放置衣物，將開始一個重新分佈衣物的洗衣流程。此舉可能延長行程時間。避免清洗單一衣物。用額外幾種衣物平衡類似地毯或牛仔夾克之類的單次衣物。
衣物皺摺、扭結或纏繞。	未按建議將衣物放入洗衣機內。	放入適量、能自由翻滾的衣物量。衣物須能自在移動，才能減少皺摺和纏繞。參閱「行程指南」，瞭解每個行程的建議衣物量。 混合不同類型的衣物，減少纏繞。選擇適合洗衣類型的建議行程。
	衣物的洗衣時間太久。	選擇較低污垢程度。注意：選擇較高污垢程度，不見得就能深層清洗該衣物。
	洗衣轉速太快。	選擇較低轉速。注意：轉速低時，比起轉速高行程，衣物會較濕。
	未即時取出洗衣機的衣物。	即時取出洗衣機的衣物，或若行程結束時無法取出衣物，使用選項。
	未為須清洗衣物選擇正確的行程。	選擇「細緻」行程或其他慢速行程，減少皺摺。
	洗衣水不夠暖，無法撫平皺痕。	若對衣物安全無礙，使用溫水或熱水。
未清潔或去除污漬	未按建議將衣物放入洗衣機內。	放入適量、能自由翻滾的衣物量。衣物應能移動自如，才能取得最佳清潔效果。參閱「行程指南」，瞭解每個行程的建議衣物量。 洗衣機啟動後僅放入一或兩件衣物。
	未使用 HE 高效能洗衣劑，或使用太多 HE 高效能洗衣劑。	僅使用 HE 高效能洗衣劑。請務必測量洗衣劑用量，並根據衣物量和污垢程度，遵循製造商的用量說明。
	硬水或水中的鐵(鐵鏽)濃度高。	您可能需要安裝軟水機及/或鐵質過濾器。
	使用衣物柔軟劑輸送球。	本洗衣機若放入輸送球，也許無法正常運行。倒入衣物柔軟劑至衣物柔軟劑放置格內。
	低速行程使用洗衣粉。	考慮使用洗衣精。

# 故障排除

首先，請嘗試此處的建議辦法，或造訪我們的網站：[www.whirlpool.com.tw](http://www.whirlpool.com.tw)

如果您經歷了	可能原因	解決方案
<b>洗衣機未如預期的妥善運行（續上頁）</b>		
未清潔或去除污漬 （續上頁）	沒有按衣物類型使用正確的行程。	使用較高污垢程度設定和暖水洗衣，增進清潔效能。
		若使用「快洗」行程，僅可清洗幾件衣物。
		用「白色」和「厚重/衣量多」行程清洗骯髒衣物。
		若為極為骯髒的衣物，請多設定「加強洗清」。
	未使用洗劑盒。	使用洗劑盒，避免漂白劑和衣物柔軟精產生的污漬。
		開始行程前注入洗劑至洗劑盒。
		針對部份機種：確定 Load & Go 洗劑智慧投放盒有加入洗劑。
		避免注入太多洗劑至洗劑盒。
除直接在衣物上具體說明的產品外，不得添加其他產品。		
洗劑盒是空的。	注入 HE 高效能洗衣劑至洗劑盒的「MAX」線。	
洗劑盒沒有確實就定位。	拉出洗劑盒、注入洗衣劑，再把它滑進定位。	
未合併清洗類似顏色的衣物。	合併清洗類似顏色的衣物，並在完成行程後立即取出衣物，能避免衣物染色。	
未使用足夠的洗衣劑，或是硬水。	用冷水或硬水清洗極骯髒衣物時，請使用較多洗衣劑。	
異味	未按建議進行每月維護。	每月或運行 30 個行程後，運行「槽洗淨」。請參閱「洗衣機維護」部份的「洗衣機保養」。
		行程完成後立即取出洗衣機的衣物。若完成清洗後無法立即從洗衣機取出衣物，使用選項。
	未使用 HE 高效能洗衣劑，或使用太多 HE 高效能洗衣劑。	僅使用 HE 高效能洗衣劑。請正確測量用量。請務必遵循製造商的說明。
		請參閱「洗衣機保養」部份。
用後門沒有維持打開。	本洗衣機配備緊密封條，避免水滲漏。為避免氣味，讓機門打開，以使用後洗衣機能風乾。	
布料損壞	洗衣行程期間，口袋裡有尖銳物品。	洗衣前清空口袋、拉上拉鍊、扣上按扣或鉤子，避免鉤破和撕裂衣物。
	繩子和帶子可能會纏繞。	開始清洗衣物前，繫上所有繩子和帶子。
	洗衣前衣物可能就已毀損。	洗衣前修補接縫處的撕裂口和斷線。
	若洗衣機塞太滿，將可能會損壞布料。	避免把衣物塞太滿。僅放入乾燥衣物。
		使用待洗衣料專用的行程。
		洗衣機啟動後僅放入一或兩件衣物。
	若機門夾住某件衣物、或把它卡在機門窗戶和橡膠封條之間，將可能會損壞布料。	不要將過量衣物裝入洗衣機。
		請將衣物完全推入洗衣機。
也許未正確添加液態含氯漂白劑。	不得將液態含氯漂白劑直接倒進衣物裡。請清除溢出的漂白劑。	
	未稀釋的漂白劑可能會損壞布料。不得使用超過製造商建議的用量。	

## 故障排除

首先，請嘗試此處的建議辦法，或造訪我們的網站：[www.whirlpool.com.tw](http://www.whirlpool.com.tw)

如果您經歷了	可能原因	解決方案
<b>洗衣機未如預期的妥善運行 (續上頁)</b>		
灰白、骯髒的顏色	未妥善分類衣物。	混合白色和有色衣物共洗可能會讓衣物染色。從白色和淺色衣物中取出深色衣物。
	洗衣溫度太低。	若衣物可用，則使用熱水或溫水。確定您的熱水系統足以供應熱水洗衣。
	未使用足夠的洗衣劑，或是硬水。	用冷水或硬水清洗極骯髒衣物時，請使用較多洗衣劑。
洗劑盒操作不正確。	洗劑盒堵塞或太早配送洗劑。	不要過度注入洗劑至洗劑盒。注入太多洗劑會讓洗劑盒立即配送洗劑。
		開始行程前注入洗劑至洗劑盒。
	漂白劑放置格內未使用液態含氯漂白劑。	低水壓家庭可能有洗劑盒殘留洗衣粉的現象。為避免此現象，視您的衣物和情況而定，可選擇用暖水洗衣。
	行程完成後有水殘留於洗劑盒。	只能將液態含氯漂白劑注入於漂白劑放置格。
行程完成後有少量水殘留於洗劑盒是正常現象。		
洗衣膠囊沒有溶解	加入膠囊的程序不正確。	確定是在放入衣物前加入膠囊。不要將膠囊加至洗劑盒。遵循製造商說明，避免損壞衣物。
行程時間變更，或行程時間太長	正常的洗衣機運作。	行程時間按水壓、水溫、洗衣劑和衣物而自動變更。您選擇的選項也將影響行程時間。
	洗衣機有過多泡沫。	偵測到過多泡沫時，將自動啟動特殊的泡沫例行作業，以清除過多泡沫，同時確保妥善沖洗衣物。此作業將增加原有行程的運行時間。
	衣物也許放置得不平均。	若未平均放置衣物，將開始一個重新分佈衣物的洗衣流程。此舉可能延長行程時間。避免清洗單一衣物。用額外幾種衣物平衡類似地毯或牛仔夾克之類的單一衣物。
	沒有按衣物類型使用正確的行程。	「快洗」行程旨在清洗少量略髒衣物 (2-4 件)。若用此行程清洗大量衣物，行程時間將增加。
		使用「快洗」或「細緻」行程時，您應清洗少量衣物。此舉確保能輕柔清洗衣物，同時不增加行程時間。
控制鍵無回應。	「按鍵鎖」已「開啟」。	觸碰並按住「按鍵鎖」3 秒，解鎖控制鍵。每按住「按鍵鎖」一秒，顯示將倒數計時一秒，您將看到「3」、「2」，然後是「1」。

---

## 幫助和服務

在打電話要求幫助或服務之前。請查閱“故障排除”章節。它可能會幫您省下叫修服務的成本。假如您還需要幫助，請遵照下列指示去作：  
在打電話之前，請先了解洗衣機之購買日期、完整的機型與機號。這些的資料可幫助我們更快地回應您的需求。

### 如果您需要更換的零件

如果您需要訂購更換之零件，我們建議您僅使用工廠指定的零件。這些零件可適當的匹配並運作正常，因為其生產製作依從所有惠而浦家電的同樣精密標準製造。

### 要在您的所在地區找到原廠指定之零件：

請直接與出售洗衣機之經銷商或惠而浦公司連絡。

---

## 進口商資訊

### 台灣惠而浦股份有限公司

消費者免付費服務專線：0800 258 558

消費者服務信箱：service\_tw@whirlpool.com

官網：[www.whirlpool.com.tw](http://www.whirlpool.com.tw)

## PRODUCT SPECIFICATIONS:

Models	8TWF5620HW	8TWF6620HW
Product name	Washer	Washer
Power supply	120 V / 60 Hz	120 V / 60 Hz
Max. wash load (dry clothes)	17.0 kg	17.0 kg
Water pressure	0.03~0.7 MPa	0.03~0.7 MPa
Rated power	500 W	1,000 W
Maximum spin speed	1,200 rpm	1,200 rpm
Product color (end digit)	W=White	W=White
Weight	96 kg	107 kg
External dimensions (H x W x D)	982 x 686 x 802 (mm)	982 x 686 x 802 (mm)

**NOTE:** Actual specifications are as shown on the machine nameplate.

For information on RoHs, please visit the official website: [www.whirlpool.com.tw](http://www.whirlpool.com.tw).

# WASHER SAFETY

## Your safety and the safety of others are very important.

We have provided many important safety messages in this manual and on your appliance. Always read and obey all safety messages.



This is the safety alert symbol.

This symbol alerts you to potential hazards that can kill or hurt you and others.

All safety messages will follow the safety alert symbol and either the word “DANGER” or “WARNING.” These words mean:

**! DANGER**

**You can be killed or seriously injured if you don't immediately follow instructions.**

**! WARNING**

**You can be killed or seriously injured if you don't follow instructions.**

All safety messages will tell you what the potential hazard is, tell you how to reduce the chance of injury, and tell you what can happen if the instructions are not followed.

## IMPORTANT SAFETY INSTRUCTIONS

**WARNING:** To reduce the risk of fire, electric shock, or injury to persons when using the washer, follow basic precautions, including the following:

- Read all instructions before using the washer.
- This appliance is not intended for use by persons (including children) with reduced physical, sensory or mental capabilities, or lack of experience and knowledge, unless they have been given supervision or instruction concerning use of the appliance by a person responsible for their safety.
- Do not wash articles that have been previously cleaned in, washed in, soaked in, or spotted with gasoline, dry-cleaning solvents, other flammable, or explosive substances as they give off vapors that could ignite or explode.
- Do not add gasoline, dry-cleaning solvents, or other flammable, or explosive substances to the wash water. These substances give off vapors that could ignite or explode.
- Under certain conditions, hydrogen gas may be produced in a hot water system that has not been used for 2 weeks or more. **HYDROGEN GAS IS EXPLOSIVE.** If the hot water system has not been used for such a period, before using the washing machine, turn on all hot water faucets and let the water flow from each for several minutes. This will release any accumulated hydrogen gas. As the gas is flammable, do not smoke or use an open flame during this time.
- Do not allow children to play on or in the washer. Close supervision of children is necessary when the washer is used near children.
- Before the washer is removed from service or discarded, remove the door or lid.
- Do not reach into the washer if the drum, tub or agitator is moving.
- Do not install or store the washer where it will be exposed to the weather.
- Do not tamper with controls.
- Do not repair or replace any part of the washer or attempt any servicing unless specifically recommended in this manual or in published user-repair instructions that you understand and have the skills to carry out.
- See Installation Instructions for grounding instructions.
- If the power supply cord is damaged, it must be replaced by manufacturer or its service agent or similarly qualified person in order to avoid a hazard.

**SAVE THESE INSTRUCTIONS**



# ACCESSORIES

## INSTALLATION & MAINTENANCE ACCESSORIES

**FACTORY CERTIFIED PARTS** – these three words represent quality parts and accessories designed specifically for your appliance. Time tested engineering that meets our strict quality specifications.

---

## FACTORY CERTIFIED PARTS

---

Accessories designed for your appliance:

Customize your new washer and dryer with the following genuine Whirlpool accessories. For more information on options and ordering, call **0800-258-558** or visit us at: [www.whirlpool.com.tw](http://www.whirlpool.com.tw).

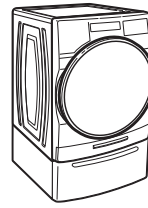

### 15" Pedestal

Color-matched pedestals raise the washer and dryer to a more comfortable working height. The large drawer provides convenient storage.

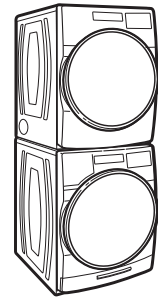

### Stack Kit

If space is at a premium, the stack kit allows the dryer to be installed on top of the washer.

# CONTROL PANEL AND FEATURES

## NOTES:

- Not all features and cycles are on all models.
- If your model has a touch interface, the control panel features a sensitive surface that responds to a light touch of your finger. To ensure your selections are registered, touch the control panel with your fingertip, not your fingernail. When selecting a setting or option, simply touch its name.
- If your model has physical buttons, make sure to press the button firmly.
- At cycle completion, your setting and option choices will be remembered for the next cycle. However, if power to the washer is lost, the settings and options will go back to the factory defaults.



### 1 POWER

Select to turn the washer on and off. Select to stop/cancel a cycle at any time.

### 2 WHAT TO WASH/HOW TO WASH

First determine what items are in the load that you are trying to wash. Use that to guide your “What to Wash” selection. Then determine how you want the washer to wash them and make the appropriate “How to Wash” selection. See “Cycle Guide” for cycle details. If you do not make a “How to Wash” selection, the washer will automatically select the recommended or last-used “How to Wash” cycle.

### 3 START/PAUSE

Touch and hold for 3 seconds until the light above Start/Pause comes on to start a cycle, or touch once while a cycle is in process to pause it.

### 4 CYCLE STATUS DISPLAY

The Cycle Status Display shows the progress of a cycle. At each stage of the process, you may notice sounds or pauses that are different from traditional washers.

### Estimated Time Remaining

The Estimated Time Remaining shows the time required for the cycle to complete. Factors such as load size, modifiers, options selected, and water pressure may affect the time shown in the display. Tightly packed loads, unbalanced loads, or excessive suds may cause the washer to lengthen the cycle time as well.

### Sensing

When Start/Pause is touched the washer will chime, indicating it is starting. The drum will make a partial turn. The door will click when it locks.

Once the door has locked, the washer will begin spinning to sense the load size. This sensing process will continue throughout the cycle.

After the load size is sensed, the estimated time based on load size will be displayed and water will be added. You may hear water flowing through the dispenser, adding detergent to the load. The actual cycle time may be lengthened; however, the display will continue to show the estimated time.

## Washing

During the wash cycle, this will display to let you know the cycle is in progress.

## PreSoak

This symbol will be displayed to let you know a presoak is in progress.



## Detergent Low (on some models)

When detergent in the bulk dispenser is running low, the display will show the detergent level (Low).

## Add Garment

When “Add Garment” is displayed, you may pause the washer, open the door, and add items. Touch and hold START/PAUSE to start the washer again.

## Door Locked

The Door Locked symbol will display to indicate that the door is locked and cannot be opened without first pausing or canceling the cycle.



## Control Lock

When the Control Lock symbol is displayed, the buttons are disabled. Touch and hold EXTRA RINSE for 3 seconds to enable the buttons.



## TumbleFresh (on some models)

This symbol will be displayed when the TumbleFresh option is activated. The load will tumble periodically for up to 12 hours.



## FanFresh (on some models)

This symbol will be displayed when the FanFresh option is activated. The fan will turn on and the load will tumble periodically for up to 12 hours.



## End

Once the cycle is complete, “End” will display. Remove the load promptly for best results.

## 5 CYCLE MODIFIERS

When you select a cycle, its default settings will light up. Touch to adjust cycle modifiers on the washer before touching START/PAUSE. Additional wash modifiers or options selected after touching Start/Pause may not activate. Once a wash setting is selected, it is saved for the cycle selected. To return to factory default cycle settings, unplug washer for 30 seconds; then plug back in. See “Cycle Guide” for default cycle settings.

**NOTE:** Some modifiers may increase or decrease the estimated time remaining.

### Temp

The recommended wash temperature is preset for each cycle. Some preset temperatures can be changed. You may select a different wash temperature based on the level of soil and type of fabric being washed. For best results, use the warmest wash water safe for your fabric, following the garment label instructions. All wash temperatures feature a cold rinse.

### Spin

The recommended spin speed is preset for each cycle. Some preset speeds can be changed.

- Faster spin speeds mean shorter dry times, but may increase wrinkling in your load.
- Slower spin speeds reduce wrinkling, but will leave your load more damp.

### Soil

The recommended soil level is preset for each cycle. Some preset soil levels can be changed. For heavily soiled and sturdy fabrics, select the Heavy Soil Level setting. For lightly soiled and delicate fabrics, select the Light Soil Level setting. Lower soil level settings will help reduce tangling and wrinkling.

## 6 UTILITY CYCLES

### Clean Washer

Use this every 30 washes to keep the inside of your washer fresh and clean. This cycle uses a higher water level. Use with affresh Washer Cleaner tablets or liquid chlorine bleach to thoroughly clean the inside of your washer. When using this cycle, the drum should be empty. This cycle should not be interrupted. See the “Washer Care” section.

### Drain & Spin

This cycle removes excess water from the load or special-care items washed by hand. Use this cycle after a power failure. For some fabrics, you may choose to set a slower spin speed.

## 7 CYCLE OPTIONS

You may add or remove options for each cycle. Not all options can be used with all cycles, and some are preset to work with certain cycles. Options vary by model.

### Steam Clean (on some models)

The Steam Clean option adds additional soak and wash time to many cycles to help remove tough stains, as well as a steam boost for added cleaning power. An integrated heater helps to maintain optimal wash temperatures. See “Cycle Guide” for cycles that allow the Steam Clean option.

You can also touch and hold STEAM CLEAN for 3 seconds to turn cycle signals on or off.

### Extra Rinse

Activate this option to add an extra rinse to most cycles.

You can also touch and hold EXTRA RINSE for 3 seconds to disable/enable the Control Lock.

### Load & Go (on some models)

Touch to select this option if you want to automatically add HE detergent to the wash load at the proper time.

**IMPORTANT:** When using the dispenser cartridge with concentrated liquid detergent, be sure to change the detergent concentration settings in the control if the detergent used is different than factory preset of 2x concentration. Change the detergent concentration setting by touching and holding TEMP and SOIL for 3 seconds.

You can also touch and hold LOAD & GO for 3 seconds to set a presoak.

### PreSoak (on some models)

Touch to add a presoak time of your choice to a wash cycle.



## 8 DISPENSERS

### Load & Go Bulk Dispenser (only on some models – varies by model)

The Load & Go bulk dispenser gives you the convenience of not having to add the HE detergent to the wash load every time. It also determines the best amount of detergent and the best time to add it to the load. See the “Using the Dispensers” section for information on using the dispenser drawer.

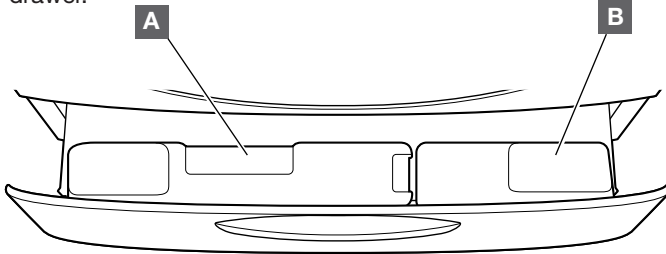

Washer comes with choice of a 1- or 2-liter bulk liquid detergent dispenser.

### Single Load Dispenser Drawer

The single load dispenser drawer gives you the convenience of adding HE detergent, liquid chlorine bleach, and liquid fabric softener to the wash load at the proper time. See the “Using the Dispensers” section for information on using the dispenser drawer.

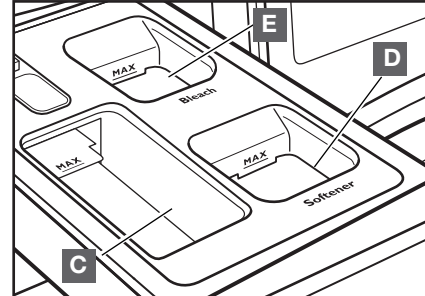

#### A 2-Liter Bulk Liquid High Efficiency (HE) detergent dispenser

This bulk dispenser holds up to 67.6 oz (2 L) of liquid HE detergent.

#### B 1-Liter Bulk Liquid High Efficiency (HE) detergent dispenser

This bulk dispenser holds up to 33.8 oz (1 L) of liquid HE detergent.

Each dispenser holds enough detergent for many loads of laundry. Each adds the appropriate quantity of HE detergent to the wash load at the proper time. See the “Using the Dispensers” section for information on using the dispenser.

**IMPORTANT:** Do not use chlorine bleach or powdered detergent in the bulk dispenser. Powdered detergent must be added to the single load dispenser. See the “Using the Washer” section.

#### C High Efficiency (HE) detergent compartment

This compartment holds liquid or powdered HE detergent for your main wash cycle, and automatically dispenses detergent in the cycle.

#### D Liquid fabric softener compartment

This compartment holds liquid fabric softener. It automatically dispenses liquid fabric softener at the optimum time in the cycle.

#### E Liquid chlorine bleach compartment

This compartment automatically dilutes and dispenses liquid chlorine bleach at the optimum time during the first rinse after the wash cycle. It cannot dilute powdered bleach.

# CYCLE GUIDE

This washer has a unique user interface to help you select the best cycle for your load. The “What to Wash” “How to Wash” layout guides you to the optimal cycle in two easy steps:

First determine what items are in the load that you are trying to wash. Use that to guide your “What to Wash” selection. Then determine how you want the washer to wash them and select the appropriate “How to Wash” selection. Selecting “What to Wash” will automatically select a default “How to Wash selection,” so selecting a “How to Wash” is optional. See chart below for more details.

What items Do You Want to Wash?	“What to Wash” Cycle Selection:
Cottons, linens, and mixed garment loads	Regular
No-iron fabrics, dress shirts/pants, synthetics, sheer/lacy garments	Delicates
Large items such as small comforters, sleeping bags, jackets, and washable rugs	Bulky Items
White fabrics/garments	Whites
Bright- or dark-colored cottons, linens, and mixed loads	Colors
Sturdy towels and washcloths	Towels

How Do You Want to Wash Them?	“How to Wash” Cycle Selection:
Regular/Normal	Normal
With fewer wrinkles	Wrinkle Control
Intense Cleaning	Heavy Duty
Eliminate 99.9% of three common household bacteria	Sanitize* (with Oxi –on some models)
Gentle cleaning with cold water	Cold Wash
Fast	Quick

Settings and options shown in **bold** are default settings for that wash cycle. For best fabric care, choose the cycle, options, and settings that best fit the load being washed. Always read and follow fabric care labels and laundry product instructions. Avoid tightly packing the washer. The washer will not rinse well or spin correctly if tightly packed. Not all settings are available with each cycle, and some options cannot be used together. Not all options are available on all models.

What	How	Basic Settings			Additional Options			
		Temp	Spin	Soil	Steam Clean	Extra Rinse	PreSoak	Load & Go
Regular	<b>Normal</b>	Hot Very Warm <b>Warm</b> Cool Cold	<b>Fast</b> Medium Fast Medium Off	Light <b>Normal</b> Heavy	✓	✓	✓	✓
	Wrinkle Control	Hot Very Warm Warm Cool <b>Cold</b>	Fast Medium Fast Medium <b>Slow</b> Off	<b>Light</b> Normal Heavy	✓	✓	✓	✓
	Heavy Duty	Hot <b>Very Warm</b> Warm Cool Cold	<b>Fast</b> Medium Fast Medium Off	Light <b>Normal</b> Heavy	✓	✓	✓	✓
	Sanitize* (with Oxi – on some models)	<b>Hot</b>	<b>Fast</b> Medium Fast Medium	<b>Light</b> Normal Heavy	✓	✓		✓
	Cold Wash	Hot Very Warm Warm Cool <b>Cold</b>	<b>Fast</b> Medium Fast Medium Off	Light Normal <b>Heavy</b>		✓	✓	✓
	Quick	Hot Very Warm <b>Warm</b> Cool Cold	<b>Fast</b> Medium Fast Medium Off	<b>Light</b> Normal Heavy	✓	✓	✓	✓

\*This cycle eliminates 99.9% of the most common bacteria found in clothes, sheets, and towels. Using the highest wash temperature available and adding a powdered Oxi product in the drum (on some models) ensures sanitization. Check recommended wash temperature of your items and use the amount of Oxi recommended by the manufacturer (on some models). Bacteria tested were K. pneumonia, P. aureginosa, and S. aureus.

What	How	Basic Settings			Additional Options			
		Temp	Spin	Soil	Steam Clean	Extra Rinse	PreSoak	Load & Go
Delicates	Normal	Hot Very Warm <b>Warm</b> Cool Cold	Fast Medium Fast Medium <b>Slow</b> Off	Light <b>Normal</b> Heavy	✓	✓	✓	✓
	Quick	Hot Very Warm <b>Warm</b> Cool Cold	Fast Medium Fast Medium <b>Slow</b> Off	<b>Light</b> Normal Heavy	✓	✓	✓	✓
	<b>Wrinkle Control</b>	Hot Very Warm Warm Cool <b>Cold</b>	Fast Medium Fast Medium <b>Slow</b> Off	<b>Light</b> Normal Heavy	✓	✓	✓	✓
	Heavy Duty	Hot <b>Very Warm</b> Warm Cool Cold	Fast Medium Fast Medium <b>Slow</b> Off	Light <b>Normal</b> Heavy	✓	✓	✓	✓
	Cold Wash	Hot Very Warm Warm Cool <b>Cold</b>	Fast Medium Fast Medium <b>Slow</b> Off	Light <b>Normal</b> Heavy		✓	✓	✓
	Sanitize* (with Oxi – on some models)	<b>Hot</b>	<b>Fast</b> Medium Fast Medium Slow Off	<b>Light</b> Normal Heavy	✓	✓		✓
Bulky Items	Normal	Hot Very Warm <b>Warm</b> Cool Cold	Fast <b>Medium Fast</b> Medium Slow Off	Light <b>Normal</b> Heavy	✓	✓	✓	✓
	Quick	Hot Very Warm <b>Warm</b> Cool Cold	Fast <b>Medium Fast</b> Medium Slow Off	<b>Light</b> Normal Heavy	✓	✓	✓	✓
	Wrinkle Control	Hot Very Warm Warm Cool <b>Cold</b>	Fast Medium Fast Medium <b>Slow</b> Off	<b>Light</b> Normal Heavy	✓	✓	✓	✓
	<b>Heavy Duty</b>	Hot <b>Very Warm</b> Warm Cool Cold	Fast <b>Medium Fast</b> Medium Slow Off	Light <b>Normal</b> Heavy	✓	✓	✓	✓
	Cold Wash	Hot Very Warm Warm Cool <b>Cold</b>	Fast <b>Medium Fast</b> Medium Slow Off	Light <b>Normal</b> Heavy		✓	✓	✓

\*This cycle eliminates 99.9% of the most common bacteria found in clothes, sheets, and towels. Using the highest wash temperature available and adding a powdered Oxi product in the drum (on some models) ensures sanitization. Check recommended wash temperature of your items and use the amount of Oxi recommended by the manufacturer (on some models). Bacteria tested were K. pneumonia, P. aureginosa, and S. aureus.

What	How	Basic Settings			Additional Options			
		Temp	Spin	Soil	Steam Clean	Extra Rinse	PreSoak	Load & Go
Whites	<b>Normal</b>	Hot Very Warm <b>Warm</b> Cool Cold	Fast <b>Medium Fast</b> Medium Slow Off	Light Normal <b>Heavy</b>	✓	✓	✓	✓
	Quick	Hot Very Warm <b>Warm</b> Cool Cold	Fast <b>Medium Fast</b> Medium Slow Off	<b>Light</b> Normal Heavy	✓	✓	✓	✓
	Wrinkle Control	Hot Very Warm Warm Cool <b>Cold</b>	Fast Medium Fast Medium <b>Slow</b> Off	<b>Light</b> Normal Heavy	✓	✓	✓	✓
	Heavy Duty	Hot <b>Very Warm</b> Warm Cool Cold	Fast <b>Medium Fast</b> Medium Slow Off	Light Normal <b>Heavy</b>	✓	✓	✓	✓
	Cold Wash	Hot Very Warm Warm Cool <b>Cold</b>	Fast <b>Medium Fast</b> Medium Slow Off	Light Normal <b>Heavy</b>		✓	✓	✓
	Sanitize* (with Oxi – on some models)	<b>Hot</b>	<b>Fast</b> Medium Fast Medium Slow Off	<b>Light</b> Normal Heavy	✓	✓		✓
Colors	Normal	Hot Very Warm <b>Warm</b> Cool Cold	Fast <b>Medium Fast</b> Medium Slow Off	<b>Light</b> Normal Heavy	✓	✓	✓	✓
	Quick	Hot Very Warm <b>Warm</b> Cool Cold	Fast <b>Medium Fast</b> Medium Slow Off	<b>Light</b> Normal Heavy	✓	✓	✓	✓
	Wrinkle Control	Hot Very Warm Warm Cool <b>Cold</b>	Fast Medium Fast Medium <b>Slow</b> Off	<b>Light</b> Normal Heavy	✓	✓	✓	✓
	Heavy Duty	Hot <b>Very Warm</b> Warm Cool Cold	Fast <b>Medium Fast</b> Medium Slow Off	<b>Light</b> Normal Heavy	✓	✓	✓	✓
	<b>Cold Wash</b>	Hot Very Warm Warm Cool <b>Cold</b>	Fast <b>Medium Fast</b> Medium Slow Off	<b>Light</b> Normal Heavy		✓	✓	✓
	Sanitize* (with Oxi – on some models)	<b>Hot</b>	<b>Fast</b> Medium Fast Medium Slow Off	<b>Light</b> Normal Heavy	✓	✓		✓

\*This cycle eliminates 99.9% of the most common bacteria found in clothes, sheets, and towels. Using the highest wash temperature available and adding a powdered Oxi product in the drum (on some models) ensures sanitization. Check recommended wash temperature of your items and use the amount of Oxi recommended by the manufacturer (on some models). Bacteria tested were K. pneumonia, P. aureginosa, and S. aureus.

What	How	Basic Settings			Additional Options			
		Temp	Spin	Soil	Steam Clean	Extra Rinse	PreSoak	Load & Go
Towels	Normal	Hot Very Warm <b>Warm</b> Cool Cold	<b>Fast</b> Medium Fast Medium Slow Off	Light Normal <b>Heavy</b>	✓	✓	✓	✓
	Quick	Hot Very Warm <b>Warm</b> Cool Cold	<b>Fast</b> Medium Fast Medium Slow Off	<b>Light</b> Normal Heavy	✓	✓	✓	✓
	Wrinkle Control	Hot Very Warm Warm Cool <b>Cold</b>	Fast Medium Fast Medium <b>Slow</b> Off	<b>Light</b> Normal Heavy	✓	✓	✓	✓
	<b>Heavy Duty</b>	Hot Very Warm Warm Cool Cold	<b>Fast</b> Medium Fast Medium Slow Off	Light Normal <b>Heavy</b>	✓	✓	✓	✓
	Cold Wash	Hot Very Warm Warm Cool <b>Cold</b>	<b>Fast</b> Medium Fast Medium Slow Off	Light Normal <b>Heavy</b>		✓	✓	✓
	Sanitize* (with Oxi – on some models)	<b>Hot</b>	<b>Fast</b> Medium Fast Medium Slow Off	<b>Light</b> Normal Heavy	✓	✓		✓

\*This cycle eliminates 99.9% of the most common bacteria found in clothes, sheets, and towels. Using the highest wash temperature available and adding a powdered Oxi product in the drum (on some models) ensures sanitization. Check recommended wash temperature of your items and use the amount of Oxi recommended by the manufacturer (on some models). Bacteria tested were K. pneumonia, P. aureginosa, and S. aureus.

## CHOOSING THE RIGHT DETERGENT

Use only High Efficiency detergents. The package will be marked “HE” or “High Efficiency.” Low-water washing creates excessive sudsing with a non-HE detergent. Using non-HE detergent will likely result in longer cycle times and reduced rinsing performance. It may also result in component malfunction and, over time, buildup of mold or mildew. HE detergents should be low-sudsing and quick-dispersing to produce the right amount of suds for the best performance. They should hold soil in suspension so it is not redeposited onto clean clothes. Not all detergents labeled as High Efficiency are identical in formulation and their ability to reduce suds. For example, natural, organic, or homemade HE detergents may generate a high level of suds. If you use one of these and see a “SUD” error code appear in the display, consider using a different HE detergent. Always follow the detergent manufacturer’s instructions to determine the amount of detergent to use.



Use only High Efficiency (HE) detergent.

### About Detergent Concentration

Today’s liquid HE detergents are concentrated. Most brands of concentrated HE detergent will show the level of concentration on the bottle.

However, if the detergent bottle does not give the concentration, it can be easily calculated. Just divide the package size in fluid ounces by the number of loads. Then refer to the chart below to find the concentration.

If you do not get your desired cleaning results, try using a lower concentration number. If you have excess suds, try using a higher concentration number.

If detergent concentration is not 2x, change the detergent concentration setting by touching and holding TEMP and SOIL for 3 seconds.

Concentration	Number of ounces ÷ number of loads
2X	1.5–2.49 (44.4 mL–73.6 mL)
3X	0.9–1.49 (26.6 mL–44.1 mL)
4X	0.7–0.89 (20.7 mL–26.3 mL)
5X	0.5–0.69 (14.8 mL–20.4 mL)
6X	0.3–0.49 (8.9 mL–14.5 mL)



# USING THE DISPENSERS (varies by model)

1. For automatic dispensing, open the bulk dispenser drawer using the handle at the base of the washer. For a single load, open the single load dispenser drawer at the top left corner of the washer and disable the Load & Go option.
2. Add laundry products as described below.
3. Slowly close the dispenser drawer. Make sure it is completely closed.

## NOTES:

- A small amount of water may remain in the single load dispenser from the previous wash cycle. This is normal.
- See “About Detergent Concentration” for information on detergent concentration.
- **On some models:** When detergent in the bulk dispenser is running low, the display will show the detergent level (Low).
- Add single-dose and Oxi-type boosters to the drum before loading items. See the “Using Your Washer” section.

## Adding HE detergent to dispenser

### Load & Go bulk dispenser (on some models)

Use only High Efficiency (HE) liquid detergents. The bulk dispensers will hold about 67.6 oz (2 L) or 33.8 oz (1 L) of liquid HE detergent, depending on dispenser, or enough for many loads of laundry.



Use only High Efficiency (HE) detergent.

#### To Fill Bulk Dispensers:

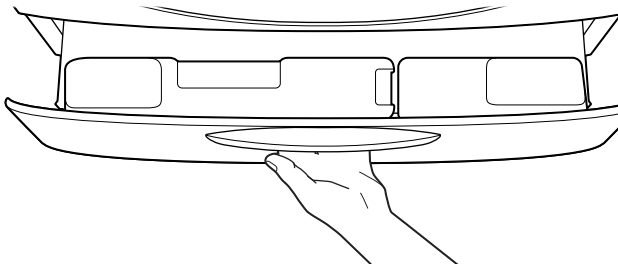

Open the dispenser drawer by pulling on the handle at the base of the washer. If desired, the drawer can be completely removed from the washer.

Locate the Load & Go bulk dispenser. Gently pull up on the tab located on the bulk dispenser lid to lift the fill door.

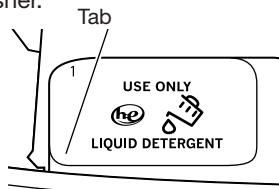

Fill to the “MAX” line (see illustrations at right) with HE liquid detergent. Close fill door. It will click into place. Make sure the concentration is correct (see the “Choosing the Right Detergent” section).

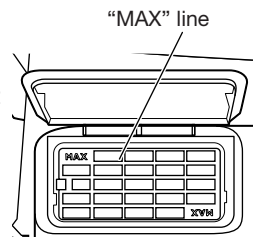

The dispensers should be rinsed out when changing detergents or when the washer will not be used for extended periods. For instructions on cleaning the dispenser cartridge, see the “Washer Care” section.

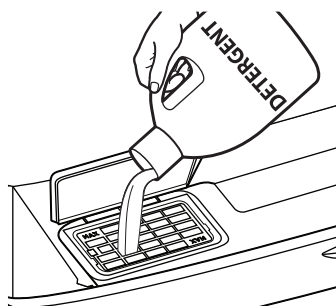

### Adding detergent for a single load

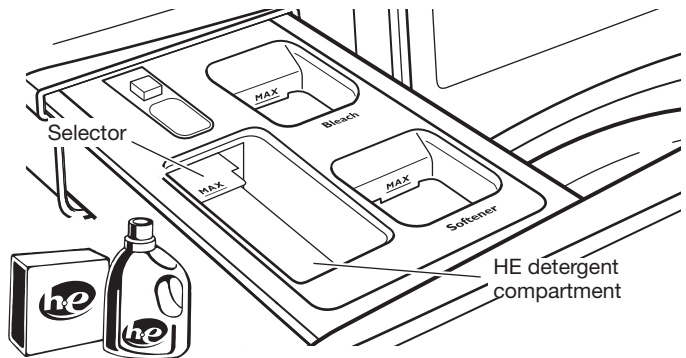

Use only High Efficiency (HE) detergent.

Pour a measured amount of HE detergent into detergent compartment. For powdered detergent, lift the selector to the high position. For liquid detergent, push down the selector to the low position.

Do not overfill; adding too much detergent may cause detergent to be dispensed into the washer too early.

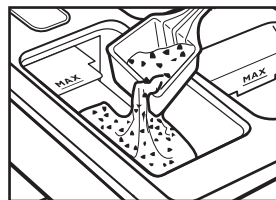

**Powdered detergent:** Lift the selector to the high position. Add directly to the compartment.

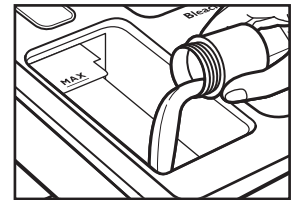

**Liquid detergent:** Push down the selector to the low position. Add directly to the compartment.

### IMPORTANT:

- Disable the Load & Go option before starting a single load.
- Do not add single-dose laundry packet to dispenser drawer.

# USING YOUR WASHER

## ⚠ WARNING



### Fire Hazard

Never place items in the washer that are dampened with gasoline or other flammable fluids.

No washer can completely remove oil.

Do not dry anything that has ever had any type of oil on it (including cooking oils).

Doing so can result in death, explosion, or fire.

### First wash cycle without laundry

Before washing clothes for the first time, set up the Load & Go bulk dispenser (on some models) or add detergent to the single-dose dispenser (see the “Using the Dispensers” section). Choose the Regular (what to wash) and Quick (how to wash) cycle and run it without clothes. Use only HE detergent. This initial cycle serves to ensure the interior is clean.

## 1. Sort and prepare your laundry

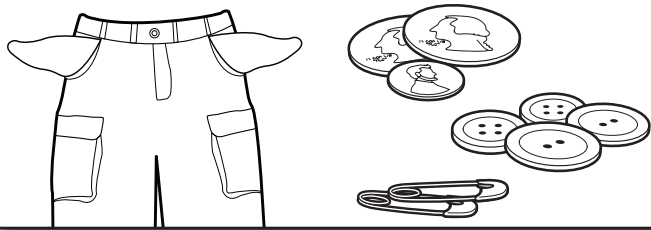

Sort items by recommended cycle, water temperature, and colorfastness. Separate heavily soiled items from lightly soiled. Separate delicate items from sturdy fabrics. Treat stains promptly and check for colorfastness by testing stain remover products on an inside seam.

### IMPORTANT:

- Empty pockets. Loose change, buttons, or any small object can plug pumps and may require a service call.
- Close zippers, fasten hooks, tie strings and sashes, and remove non-washable trim and ornaments.
- Mend rips and tears to avoid further damage to items during washing.

## ⚠ WARNING



### Electrical Shock Hazard

Plug into a grounded 3 prong outlet.

Do not remove ground prong.

Do not use an adapter.

Do not use an extension cord.

Failure to follow these instructions can result in death, fire, or electrical shock.

- Turn knits inside out to prevent pilling. Separate lint-takers from lint-givers. Synthetics, knits, and corduroy fabrics will pick up lint from towels, rugs, and chenille fabrics.
- Do not dry garments if stains remain after washing because heat can set stains into fabric.
- Always read and follow fabric care labels and laundry product instructions. Improper usage may cause damage to your garments.

## 2. Add laundry products, if desired

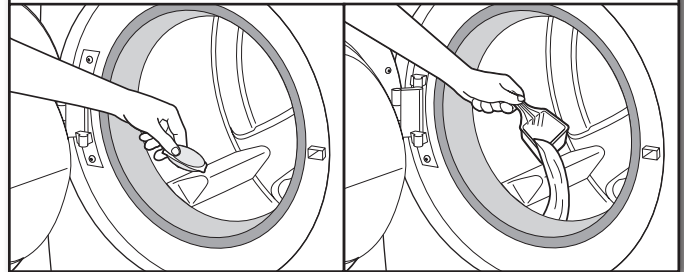

Single-dose laundry packets, Oxi-type boosters, color-safe bleach, or scented crystals can be added to the drum prior to adding laundry. When using single-dose laundry packets, make sure that the bulk dispenser is disabled (on some models) or off (see the “Control Panel and Features” section).

**NOTE:** Always follow manufacturer’s instructions.

### 3. Load laundry into washer

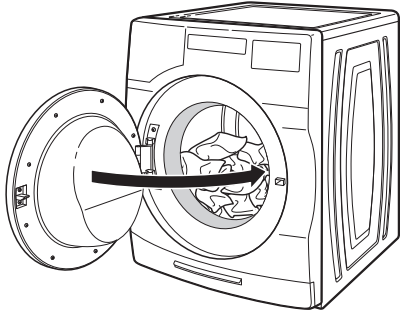

Place a load of sorted items loosely in the washer. Items need to move freely for best cleaning and to reduce wrinkling and tangling. If using the Wash & Dry option, loading the drum half full or less and not interrupting the drying cycle by opening the door will improve drying performance and cycle time. Close the washer door by pushing it firmly until the latch clicks.

- Push load fully into the washer. Make sure no items are resting on the rubber seal to avoid trapping them between the seal and the door window.
- Mix large and small items and avoid washing single items. Load evenly.
- Wash small items in mesh garment bags. For multiple items, use more than one bag and fill bags equally.

### 4. Add HE detergent

#### Load & Go Bulk Dispenser (on some models)

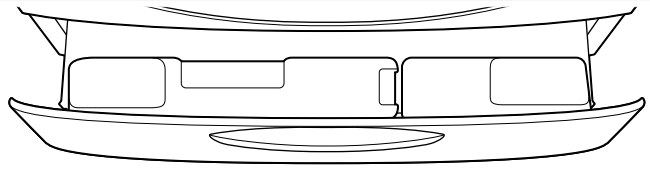

Liquid HE detergent  
bulk dispenser

If the bulk dispenser already contains enough detergent to wash your load, simply choose the Load & Go option as described in Step 10. If you need to add detergent to the bulk dispenser, see “Using the Dispensers” section.

OR

#### Single Load Dispenser Drawer

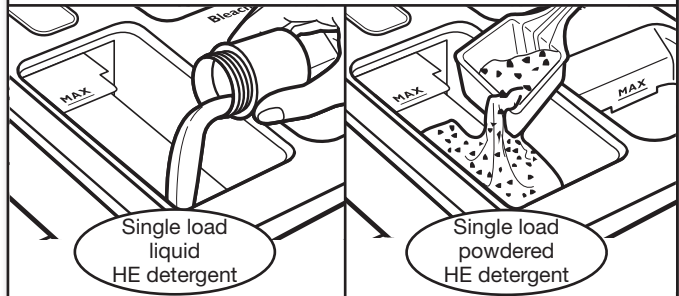

Adjust the selector, based on type of HE detergent used (either liquid or powdered). Add a measured amount of detergent directly into the detergent compartment. See the “Using the Dispensers” section. Disable the Load & Go option.

**NOTE:** Do not add single-dose laundry packets, Oxi-type boosters, color-safe bleach, or scented crystals to dispensers. They will not dispense correctly.

## 5. Add liquid fabric softener to single load dispenser, if desired

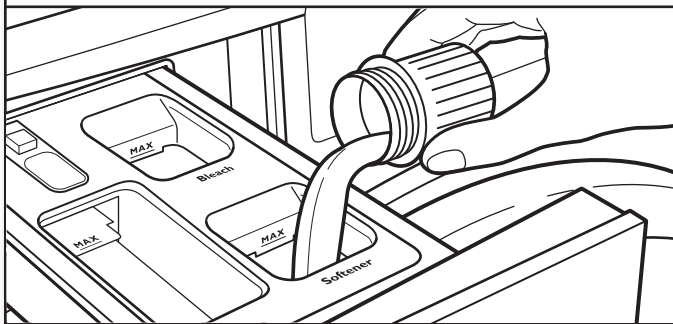

Pour a measured amount of liquid fabric softener into liquid fabric softener compartment. Always follow manufacturer's directions for correct amount of fabric softener, based on your load size.

Fabric softener is always dispensed in the last rinse, even if Extra Rinse is selected.

**IMPORTANT:** Do not overfill, dilute, or use more than the manufacturer-recommended quantity of fabric softener. Do not fill past the "MAX" line. Overfilling dispenser will cause fabric softener to immediately dispense into washer.

- Do not spill or drip any fabric softener onto the clothes.
- Do not use liquid fabric softener dispenser balls in this washer. They will not dispense correctly.
- Do not use fabric softener sheets, as they can stain the load.

## 6. Add liquid chlorine bleach to single load dispenser, if desired

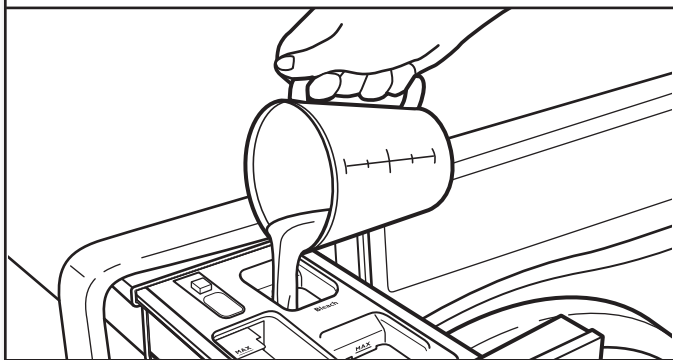

Add liquid chlorine bleach to the bleach compartment. Do not overfill, dilute, or use more than 2/3 cup (165 mL). Do not use color-safe bleach or Oxi in the same cycle with liquid chlorine bleach.

### IMPORTANT:

- Always measure liquid chlorine bleach. Use a measuring cup with a pour spout; do not guess.
- Do not fill beyond the "MAX" line. Overfilling could cause garment damage.
- Do not use thickened, easy-pour, or no-splash bleach when running the Clean Washer with affresh cycle, as excess suds may occur.
- On some models: Do not add liquid chlorine bleach to the bulk dispenser.
- Slowly close dispenser drawers. Make sure the drawers are closed completely.

## 7. Touch POWER to turn on washer

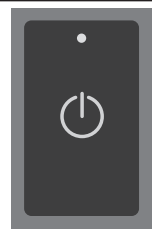

## 8. Select a wash program/cycle



First, choose what you want to wash by touching a selection in the top row. Next, choose how you want to wash your load by touching a selection in the bottom row to choose the best cycle combination for your load. See "Cycle Guide" for details on cycles features.

## 9. Adjust cycle modifiers, if desired\*



The led indicator lights will show the default settings for the selected cycle. To adjust a setting, touch its name – Temp, Spin, or Soil. Adjusting settings may change the Estimated Time Remaining. Tightly packing the load, unbalanced loads, or excessive suds may also cause the washer to increase the cycle time.

## 10. Select any additional options\*

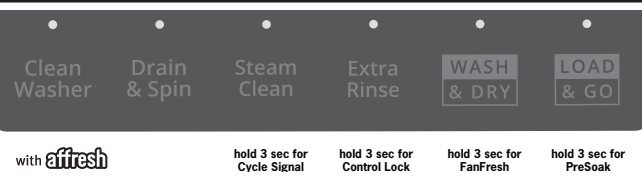

To add an option to the cycle, touch its name – Steam Clean, Extra Rinse, or Wash & Dry. If you wish to use the bulk dispenser (on some models), select Load & Go. For other options, touch and hold the buttons indicated for 3 seconds. To remove an option from the selected cycle, touch that button again.

\*Not all options and settings are available with all cycles. See "Cycle Guide" for available options and settings.

## 11. Touch and hold START/PAUSE to begin wash cycle

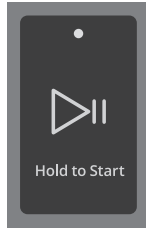

Touch and hold START/PAUSE for 3 seconds to start the wash cycle. To pause a cycle in progress, touch START/PAUSE once; then touch and hold again to continue the cycle. To cancel a cycle, touch and hold POWER and run Drain & Spin to remove any excess water.

Once you touch and hold START/PAUSE, you will hear the door lock. The washer door will remain locked during the wash cycle.

### Unlocking the door to add garments:

If you need to open the door to add one or two missed garments, you may do so while the “Add Garment” light is lit. The time allowed to add a garment will vary based on cycle selection and load size.

Touch START/PAUSE once; the door will unlock once the washer movement has stopped. This may take several minutes. Then close door and touch and hold START/PAUSE again to restart the cycle.

### Adding items after “Add Garment” light is off:

Cancel current cycle. Water will drain and you will need to reselect cycle and restart.

For best wash performance and optimal energy savings, add garments only when the “Add Garment” light is on.

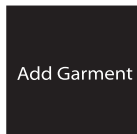

## 12. Remove garments promptly after cycle is finished

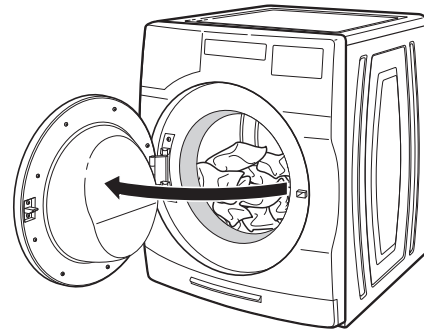

Promptly remove garments after cycle has completed to avoid odor and rusting of metal objects on garments. When unloading garments, pull back the door seal and check for small items between the tub and the washer drum.

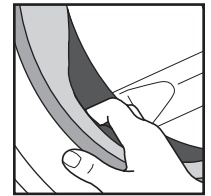

If you will be unable to remove the load promptly, use the FanFresh option if it is available on your model. If the FanFresh option is selected, the washer will automatically activate the fan once the cycle ends and tumble the load periodically for up to 12 hours. After a Wash & Dry cycle, promptly remove garments after cycle has completed to reduce wrinkling.

### NOTES:

- To cancel the FanFresh option, touch POWER or START/PAUSE.
- This washer has a tight seal to avoid water leaks. To avoid odors, leave the door open to allow the washer to dry between uses.
- If a dry cycle is interrupted and the load removed before the cool-down period at the end of the cycle, the load will be very hot.

# WASHER MAINTENANCE

## WATER INLET HOSES

Replace inlet hoses after five years of use to reduce the risk of hose failure. Periodically inspect and replace inlet hoses if bulges, kinks, cuts, wear, or leaks are found.

When replacing your inlet hoses:

Mark the date of replacement on the label with a permanent marker.

Check that the old washers are not stuck on the washer inlet valves.

Use new washers in the new inlet hoses to ensure a proper seal.

## WASHER CARE

### Recommendations to Help Keep Your Washer Clean and Performing at Its Best

1. Always use High Efficiency (HE) detergents and follow the HE detergent manufacturer's instructions regarding the amount of HE detergent to use. Never use more than the recommended amount because that may increase the rate at which detergent and soil residue accumulate inside your washer which, in turn, may result in undesirable odor.
2. Use warm or hot water washes sometimes (not exclusively cold water washes) because they do a better job of controlling the rate at which soils and detergent accumulate.
3. Always leave the washer door slightly ajar between uses to help dry out the washer and avoid the buildup of odor-causing residue.
4. Periodically clean residue from all interior surfaces of the window. For better care, wipe the entire inside of the door with a damp cloth.

### Cleaning Your Front Loading Washer

Read these instructions completely before beginning the routine cleaning processes recommended below. This washer maintenance procedure should be performed, at a minimum, once per month or every 30 wash cycles, whichever occurs sooner, to control the rate at which soils and detergent may otherwise accumulate in your washer.

#### Cleaning the Door Seal

1. Open the washer door and remove any clothing or items from the washer.
2. Inspect the gray-colored seal between the door opening and the drum for stained areas, soil buildup, or lint. Pull back the seal to inspect all areas under the seal and to check for foreign objects or lint.
3. If stained areas, soil buildup, or lint are found, wipe down these areas of the seal using either of the following two procedures:
  - a. **affresh Machine Cleaning Wipes Procedure:**
    - i. When the cycle is complete, gently pull back the rubber door seal and clean the entire surface with the textured side of an affresh Machine Cleaning Wipe.
  - b. **Dilute Liquid Chlorine Bleach Procedure:**
    - i. Mix a dilute bleach solution, using 3/4 cup (177 mL) of liquid chlorine bleach and 1 gallon (3.8 L) of warm tap water.
    - ii. Wipe the seal area with the dilute solution, using a damp cloth.

## WASHER CARE (cont.)

iii. Let stand 5 minutes.

iv. Wipe down area thoroughly with a dry cloth and let washer interior air dry with door open.

### IMPORTANT:

- Wear rubber gloves when cleaning with bleach.
- Refer to the bleach manufacturer's instructions for proper use.

### Cleaning the Inside of the Washer

This washer has a special cycle that uses higher water volumes in combination with affresh Washer Cleaner or regular liquid chlorine bleach to thoroughly clean the inside of the washer. Steam washer models also utilize steam to enhance cleaning in this special cycle.

**IMPORTANT:** Do not use thickened, easy-pour, or no-splash bleach when running the Clean Washer with affresh cycle as excess suds may occur.

**NOTE:** Read these instructions completely before beginning the cleaning process.

### Begin procedure

#### 1. Clean Washer with affresh Cycle Procedure (Recommended for best performance):

- a. Open the washer door and remove any clothing or items.
- b. Use an affresh Machine Cleaning Wipe or a soft, damp cloth or sponge to clean the inside door window.
- c. Add an affresh Washer Cleaner tablet to the washer drum.
- d. Do not add the affresh Washer Cleaner tablet to the dispenser drawer.
- e. Do not add any detergent or other chemical to the washer when following this procedure.
- f. Close the washer door.
- g. Select the Clean Washer with affresh cycle.
- h. **On some models:** Select the FanFresh option to help dry the washer interior after the cycle is complete.

**NOTE:** The washer remembers your last option selection and will use it for future wash cycles until you deselect that option.

- i. Touch and hold START/PAUSE to begin the cycle. The Clean Washer with affresh cycle operation is described below.

#### 2. Chlorine Bleach Procedure:

- a. Open the washer door and remove any clothing or items.
- b. Open the single load dispenser drawer and add regular liquid chlorine bleach to the "MAX" line in both the bleach compartment and the fabric softener compartment. Either traditional or HE chlorine bleach can be used.

**IMPORTANT:** Do not use thickened, easy-pour, or no-splash bleach as excess suds may occur.

**NOTE:** Use of more liquid chlorine bleach than is recommended above could cause washer damage over time.

## WASHER CARE (cont.)

- c. Close the washer door and the dispenser drawer.
- d. Do not add any detergent or other chemicals to the washer when following this procedure.
- e. Select the Clean Washer with affresh cycle.
- f. **On some models:** Select the FanFresh option to help dry the washer interior after the cycle is complete.  
**NOTE:** The washer remembers your last option selection and will use it for future wash cycles until you deselect that option.
- g. Touch and hold START/PAUSE to begin the cycle. The Clean Washer with affresh cycle operation is described below.

**NOTE:** For best results, do not interrupt cycle.

### Description of Clean Washer with affresh Cycle Operation:

1. The Clean Washer with affresh cycle will determine whether clothing or other items are in the washer.
2. If no items are detected in the washer, it will proceed with the cycle.
  - a. If any items are detected in the washer, “rL” (remove load) will be displayed. The door will unlock. Open washer and remove any garments from the washer drum.
  - b. Touch POWER to clear the “rL” code.
  - c. Touch and hold START/PAUSE to restart the cycle.
3. **Steam models only:** During the first 20 minutes of the cycle, it will activate the steamer but the drum will not spin or fill with water. You may see condensation on the door window during this initial phase. If you are using an affresh Washer Cleaner tablet, it will not dissolve completely during the steam phase. This is normal.

After the cycle is complete, leave the door open slightly to allow for better ventilation and drying of the washer interior.

### Cleaning the Dispensers

After using the Clean Washer with affresh cycle, you may find some residue buildup in the washer’s dispensers.

To remove residue from the single load dispenser, remove the drawer and wipe the surfaces with an affresh Machine Cleaning Wipe or a damp cloth and towel dry either before or after you run the Clean Washer with affresh cycle. Use an all-purpose surface cleaner, if needed.

On some models: To remove residue from the Load & Go bulk dispenser, lift the handle on the dispenser housing and pull to remove it from the washer cabinet; then rinse the dispenser thoroughly with running water. Wipe the outside dispenser surface with an affresh Machine Cleaning Wipe or a damp cloth, and towel dry. Use an all-purpose surface cleaner, if needed.

Replace the dispenser in the washer cabinet and make sure that it is correctly seated.

**IMPORTANT:** Dispensers are not dishwasher-safe.

### Cleaning the Outside of the Washer

Use an affresh Machine Cleaning Wipe or a soft, damp cloth or sponge to wipe up any spills. Occasionally wipe the outside of your washer to help keep it looking new. Use an affresh Machine Cleaning Wipe or mild soap and water.

**IMPORTANT:** To avoid damaging the washer’s finish, do not use abrasive products.

## CLEAN WASHER CYCLE REMINDER

**NOTE:** Not all models have the Clean Washer with affresh cycle reminder light.

The Clean Washer with affresh LED will flash at the end of a wash cycle when the washer has run 30 wash cycles. This is a reminder to run the Clean Washer with affresh cycle.

If the Clean Washer with affresh cycle is not turned on, the LED will stop flashing at the end of a wash cycle after running three more regular wash cycles. After 30 more wash cycles are completed, the Clean Washer with affresh LED will again flash at the end of a wash cycle as a reminder.

## REMOVING THE DISPENSER (cont.)

### Single Load Dispenser Drawer

#### Removing the Dispenser

##### To remove:

1. Pull dispenser drawer out until it stops.
2. Press down on the release tab and pull straight out to remove the dispenser.

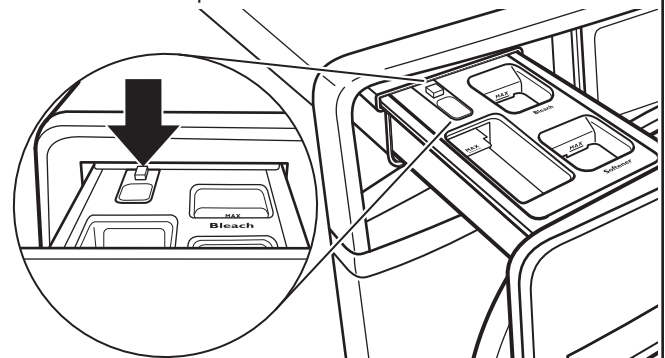

3. Lift off cover panel by pulling straight up.

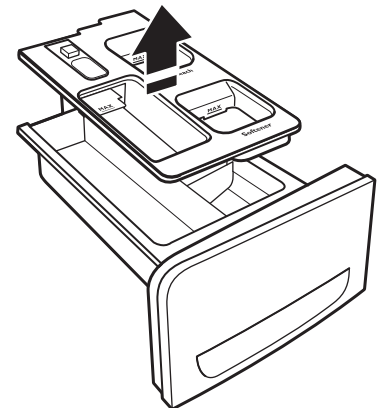

##### To replace:

1. Position cover panel back onto posts on dispenser. Apply slight pressure on cover panel to seat it.
2. Align edges of dispenser with guides in washer; then slide dispenser back into slot.

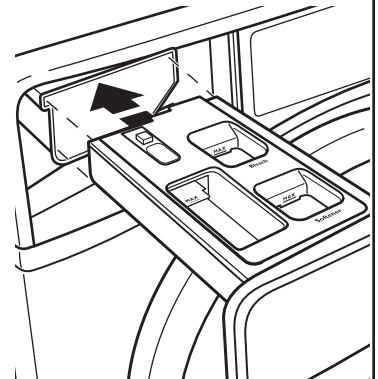

## CLEANING LOAD & GO CONTAINERS (on some models)

It is recommended that you rinse out the Load & Go containers when refilling, when changing detergent types or concentrations, or when the washer will not be used for an extended period.

1. Pull the dispenser drawer out until it stops.
2. Lift out the Load & Go containers.
3. Lift the fill lid and flush interior thoroughly with warm water.

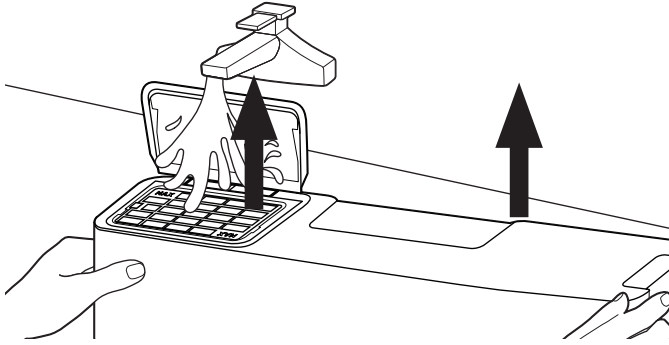

4. Allow to air dry.

**IMPORTANT:** Containers are not dishwasher-safe.

## NON-USE AND VACATION CARE

Operate your washer only when you are home. If moving or not using your washer for a period of time, follow these steps:

1. Unplug or disconnect power to washer.
2. Turn off water supply to washer to avoid flooding due to water pressure surges.

**HELPFUL TIP:** Attach a reminder note to the washer to turn the water back on before washer's next use.

3. Clean the dispensers. See "Cleaning the Dispensers."

## WINTER STORAGE CARE

**IMPORTANT:** To avoid damage, install and store washer where it will not freeze. Because some water may stay in hoses, freezing can damage washer. If storing or moving during freezing weather, winterize your washer.

### To winterize washer:

1. Shut off both water faucets; then disconnect and drain water inlet hoses.

**HELPFUL TIP:** Attach a reminder note to the washer to turn the water back on before washer's next use.

2. Put 1 qt. (1 L) of R.V.-type antifreeze in washer drum and run washer on Normal cycle for about 2 minutes to mix antifreeze and remaining water.
3. Unplug washer or disconnect power.

## TRANSPORTING YOUR WASHER

1. Shut off both water faucets. Disconnect and drain water inlet hoses.
2. If washer will be moved during freezing weather, follow "Winter Storage Care" directions before moving.
3. Disconnect drain hose from drain system and from back of washer.
4. Unplug power cord.
5. Place inlet hoses and drain hose inside washer drum.
6. Bundle power cord with a rubber band or cable tie to keep it from hanging to the ground.

**IMPORTANT:** Call for service to install new transport bolts. Do not reuse transport bolts. Washer must be transported in the upright position. To avoid structural damage to your washer, it must be properly set up for relocation by a certified technician.

## ⚠ WARNING



### Electrical Shock Hazard

Plug into a grounded 3 prong outlet.

**Do not remove ground prong.**

**Do not use an adapter.**

**Do not use an extension cord.**

**Failure to follow these instructions can result in death, fire, or electrical shock.**

## REINSTALLING/USING WASHER AGAIN

To reinstall washer after non-use, vacation, winter storage, or moving:

1. Refer to Installation Instructions to locate, level, and connect washer.
2. Before using again, run washer through the following recommended procedure:

### To use washer again:

1. Flush water pipes and hoses. Reconnect water inlet hoses. Turn on both water faucets.
2. Plug in washer or reconnect power.
3. Run washer through Heavy Duty cycle to clean washer and remove antifreeze, if used. Use only HE detergent. Use half the manufacturer's recommended amount for a medium-size load.



## ⚠ WARNING



### Electrical Shock Hazard

Disconnect power before cleaning.

Replace all parts and panels before operating.

Failure to do so can result in death or electrical shock.

## CLEANING THE DRAIN PUMP FILTER/ DRAINING RESIDUAL WATER (on some models)

**NOTE:** Perform the following procedure occasionally.

1. Open the dispenser drawer by pulling on the handle at the base of the washer/dryer. This will reveal the drain pump filter. Remove the drawer by releasing the tab on each side.

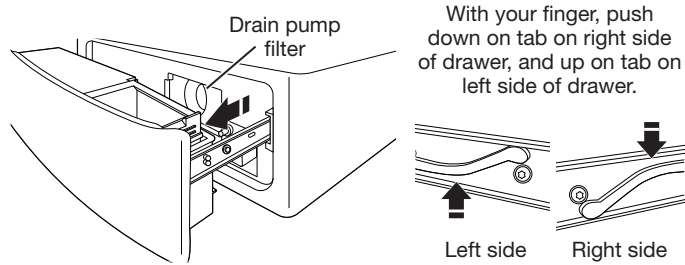

2. Place a broad, flat container beneath the drain pump filter to collect the drain water. Release the black hose from the hose clip, remove the plug, and drain the hose into the container. Empty the container. Repeat this procedure if necessary until all the water has drained. Make sure that the black hose is completely dry, replace the plug, and secure the hose in the clip.

**NOTE:** If water does not drain well, push in hose slightly to remove any possible kinks.

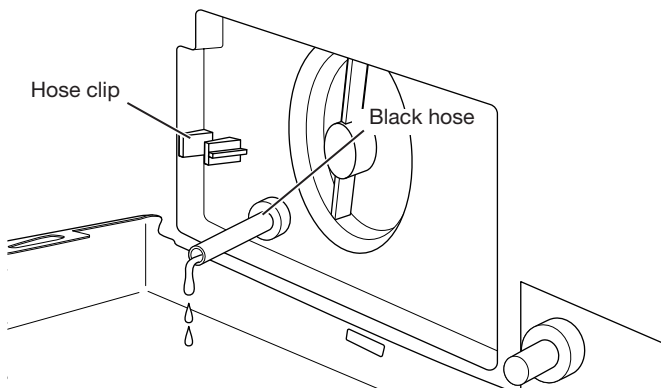

3. Lay a cotton cloth beneath the drain pump filter to absorb any water still in it. Then remove the drain pump filter by turning it counterclockwise.

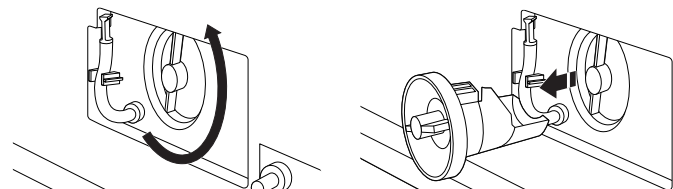

## CLEANING THE DRAIN PUMP FILTER/ DRAINING RESIDUAL WATER (cont.)

4. Remove large clumps of lint by hand from the filter and place lint in a suitable waste container. Remove remaining residue from the filter by rinsing with water.

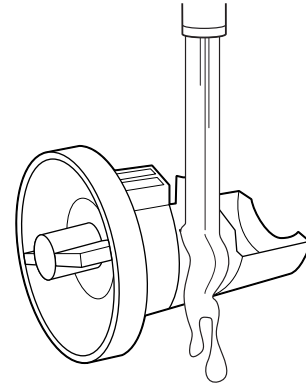

5. Reinsert the drain pump filter by turning it clockwise. Make sure to turn it in as far as it will go, with the filter handle remaining as close as possible to the vertical position.

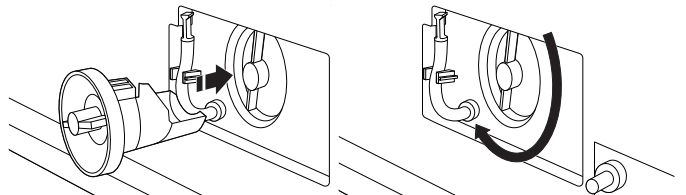

6. Replace and close the dispenser drawer. Make sure to insert both rails simultaneously when replacing the drawer. You will hear a clicking sound that indicates the rails have engaged. To ensure proper placement of the drawer, pull out fully. The drawer should be fully engaged and the rails locked in place. Make sure the drain hose is secured in the hose clip and tucked underneath the cutout.

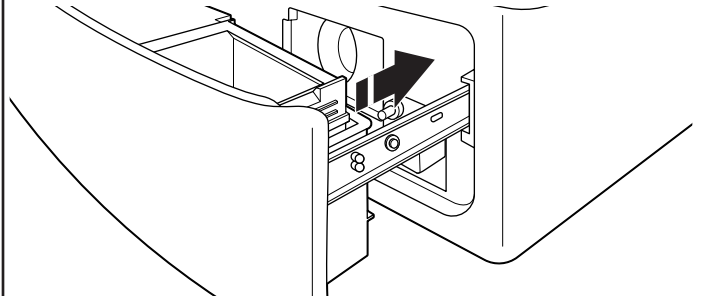

## ADDITIONAL CLEANING

Gently pull back the rubber door seal and clean any stained areas, soil buildup, or lint with the textured side of an affresh Machine Cleaning Wipe.

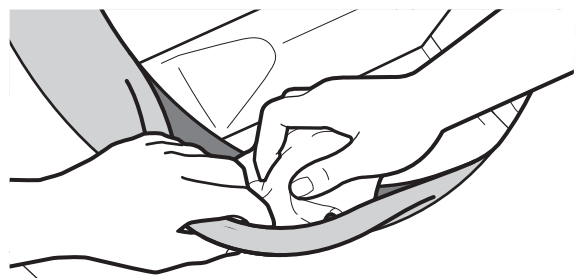

# TROUBLESHOOTING

First try the solutions suggested here or visit our website at [www.whirlpool.com.tw](http://www.whirlpool.com.tw).

If you experience	Possible Causes	Solution
<b>Error Code Appears in Display (for 2- and 3-digit displays)</b>		
Once any possible issues are corrected, touch POWER once to clear the code. Reselect and restart the cycle.		
"Sd" or "SUD" (excess suds) appears in display	Excessive suds in washer. Washer is running a suds reduction routine.	Allow the washer to continue. Use only HE detergent. Always follow the detergent manufacturer's instructions to determine the amount of detergent to use, and base detergent quantity on load size. Not all detergents labeled as High Efficiency are identical in formulation and their ability to reduce suds. For example, natural, organic, or homemade HE detergents may generate a high level of suds. If you use one of these and see a "SUD" error code appear in the display, consider using a different HE detergent.
"Lo" followed by "FL" or "F8" followed by "E1" or "Lo" followed by "FL" or "F08" followed by "E01" (water supply error) appears in display	Check for proper water supply.	Unit will drain for 8 minutes while door remains locked. The drain cycle must be allowed to complete, or the error code cannot reset. When complete, touch POWER once to clear the code. Then touch POWER again to restart washer. If code appears again, call for service.
		Both hoses must be attached and have water flowing to the inlet valve.
		Both hot and cold water faucets must be on.
		Inlet valve screens on washer may be clogged.
		Remove any kinks in the inlet hose.  If used, auto shut-off connectors and hoses must be properly installed and in working order.
Check for proper inlet hoses.	Use only manufacturer's recommended inlet hoses.	
"F9" followed by "E1" or "F09" followed by "E01" (drain pump system error) appears in display	Check plumbing for correct drain hose installation. Drain hose extends into standpipe farther than 4½" (114 mm).	Check drain hose for proper installation.
		Make sure the drain hose is not kinked, pinched, or blocked.
		Remove any clogs from drain hose.
		Use drain hose form and securely attach to drainpipe or tub.
		Lower drain hose if the end is higher than 96" (2.4 m) above the floor.
Not using HE detergent or using too much HE detergent.	Use only HE detergent. Always measure detergent and follow manufacturer's directions based on load size and soil level.	
"F5" followed by "E2" or "F05" followed by "E02" (door will not lock) appears in display	Washer door not locking.	Touch POWER to cancel the cycle. Check that the door is closed completely and latching. Check for items in the washer drum that may be keeping the door from closing completely.

# TROUBLESHOOTING

First try the solutions suggested here or visit our website at [www.whirlpool.com.tw](http://www.whirlpool.com.tw).

If you experience	Possible Causes	Solution
<b>Error Code Appears in Display (for 2- and 3-digit displays) (cont.)</b>		
"rL" (remove load) appears in display	Load detected in drum during Clean Washer with affresh cycle.	Remove items from washer drum and restart Clean Washer with affresh cycle.

## **WARNING**



### **Electrical Shock Hazard**

**Plug into a grounded 3 prong outlet.**

**Do not remove ground prong.**

**Do not use an adapter.**

**Do not use an extension cord.**

**Failure to follow these instructions can result in death, fire, or electrical shock.**

F# E# or F## E## code other than as described above appears in display	System error code.	Touch POWER once to clear the code. Then touch POWER again to restart washer. If code appears again, call for service. Unplug washer for 30 seconds; then plug back in.
Washer making error beeps	Door has not been opened and closed for at least three cycles.	This code may occur when the washer is first turned on. Open and close the door to clear the display.
Washer beeps when Start/ Pause is touched	Door not closed.	Close the door completely.
Clean Washer LED flashing at end of wash cycle (on some models)	The washer has run 30 wash cycles and is indicating a reminder to run the Clean Washer with affresh cycle.	Run the Clean Washer with affresh cycle. If the Clean Washer with affresh cycle is not turned on, the LED will stop flashing at the end of a wash cycle after running three more regular wash cycles. After 30 more wash cycles are completed, the Clean Washer with affresh LED will again flash at the end of a wash cycle as a reminder.

# TROUBLESHOOTING

First try the solutions suggested here or visit our website at [www.whirlpool.com.tw](http://www.whirlpool.com.tw).

If you experience	Possible Causes	Solution
<b>Vibration or Off-Balance</b>		
Vibration, rocking, or "walking"	Feet may not be in contact with the floor and locked.	Front and rear feet must be in firm contact with floor, and washer must be level to operate properly. Jam nuts must be tight against the bottom of the cabinet.
	Washer may not be level.	Check floor for flexing or sagging. If flooring is uneven, a 3/4" (19 mm) piece of plywood under your washer will reduce sound. Do not install washer on a raised wooden platform. See "Level the Washer" in Installation Instructions.
	Load could be unbalanced or too large.	Avoid tightly packing the load. Avoid washing single items. Balance a single item such as a rug or jeans jacket with a few extra items. Item or load not suitable for selected cycle. See "Cycle Guide" and "Using Your Washer."
	The shipping bolts are still in the back of the washer.	See "Remove transport bolts from washer" in the Installation Instructions.
<b>Noises</b>		
Clicking or metallic noises	Door locking or unlocking.	After starting a cycle the drum will make a partial turn and the door will lock. The door will remain locked until the end of cycle. This is normal.
	Objects caught in washer drain system.	Empty pockets before washing. Loose items such as coins could fall between washer drum and tub or may block pump. It may be necessary to call for service to remove items. It is normal to hear metal items on clothing such as metal snaps, buckles, or zippers touch against the stainless steel drum.
Gurgling or humming	Washer may be draining water.	The pump may make a humming sound with periodic gurgling or surging as final amounts of water are removed during the spin/drain cycles. This is normal at certain stages of the cycle.
Rolling or sloshing and occasional clicking (on slow-speed spin)	Steel balls in the balancing system are balancing the load.	This is normal at certain stages of the cycle.
<b>Water Leaks</b>		
Check the following for proper installation	Fill hoses not attached tightly.	Tighten fill-hose connection.
	Fill hose washers.	Properly seat all four fill-hose flat washers.
	Drain hose connection.	Check that the drain hose is properly secured to drainpipe or laundry tub.
	One some models: Drain pump filter is not properly seated.	One some models: Make sure filter is correctly placed in the housing. See "Cleaning the Drain Pump Filter/Draining Residual Water."
	Check household plumbing for leaks or clogged sink or drain.	Water can back up out of a clogged sink or drainpipe. Check all household plumbing for leaks (laundry tubs, drain pipe, water pipes, and faucets.)
Strainer (or nylon stocking) on end of drain hose is clogged.	Remove strainer/stocking from drain hose.	

# TROUBLESHOOTING

First try the solutions suggested here or visit our website at [www.whirlpool.com.tw](http://www.whirlpool.com.tw).

If you experience	Possible Causes	Solution
<b>Water Leaks (cont.)</b>		
Water or suds leaking from door or rear of cabinet	Not using HE detergent or using too much HE detergent.	Only use HE detergent. Suds from regular detergents can cause leaking from the door or rear of cabinet. Always measure detergent and follow manufacturer's directions based on your load requirements.
	Using thickened, easy-pour, or no-splash bleach when running the Clean Washer with affresh cycle.	Use affresh tablet or regular, non-thickened chlorine bleach when running the Clean Washer with affresh cycle.
	Residue on door window.	Periodically clean the underside of the window to avoid potential leaks.
	Door opened during "Add Garment."	Water can drip off the inside of the door when the door is opened after the start of a cycle.
Leaking around door	Hair, lint, or other debris on inner door window preventing proper seal with rubber door seal.	Clean inner door window and seal. See "Cleaning the Door Seal" in the "Washer Maintenance" section.
<b>Washer Not Performing As Expected</b>		
Load not completely covered in water	Water level not visible on door or does not cover clothes.	This is normal for an HE front-load washer. The washer senses load sizes and adds the correct amount of water for optimal cleaning.
Washer won't run or fill; washer stops working	Check for proper water supply.	Both hoses must be attached and have water flowing to the inlet valve.
		Both hot and cold water faucets must be turned on.
		Check that inlet valve screens have not become clogged.
		Check for any kinks in inlet hoses, which can restrict water flow.

## ⚠ WARNING



### Electrical Shock Hazard

**Plug into a grounded 3 prong outlet.**

**Do not remove ground prong.**

**Do not use an adapter.**

**Do not use an extension cord.**

**Failure to follow these instructions can result in death, fire, or electrical shock.**

Washer won't run or fill; washer stops working (cont.)	Check proper electrical supply.	Plug power cord into a grounded 3 prong outlet.
		Do not use an extension cord.
		Ensure there is power to outlet.
		Do not plug into a GFCI (Ground Fault Circuit Interrupter).
		Check electrical source or call an electrician to check if voltage is low.
		Reset a tripped circuit breaker. Replace any blown fuses.
		<b>NOTE:</b> If problems continue, contact an electrician.

# TROUBLESHOOTING

First try the solutions suggested here or visit our website at [www.whirlpool.com.tw](http://www.whirlpool.com.tw).

If you experience	Possible Causes	Solution
<b>Washer Not Performing As Expected (cont.)</b>		
Washer won't run or fill; washer stops working (cont.)	The load size is being sensed.	After the load size is sensed, the estimated time based on load size will be displayed and water will be added.
	Normal washer operation.	Door must be completely closed and latched for washer to run.
		The washer pauses for about 2 minutes during certain cycles. Allow the cycle to continue. Some cycles feature periods of tumbling and soak.
		Washer may be stopped to reduce suds. Use only a proper amount of HE detergent.
		Cold Wash uses less water in the beginning of the cycle to provide a high concentration of detergent for optimal cleaning action. Following this concentrated tumbling, more water is used to complete the wash.
		During the first 20 minutes of the Clean Washer with affresh cycle, it will activate the steamer but the drum will not spin or fill with water. You may see condensation on the door window during this initial phase. If you are using an affresh Washer Cleaner tablet, it will not dissolve completely during the steam phase. This is normal.
	The washer door is not firmly shut.	The door must be closed during operation.
	On some models: The Load & Go bulk dispenser is not fully seated in the washer.	Make sure that the Load & Go bulk dispenser is fully seated in the washer, and that the lid on the bulk dispenser is firmly closed.
	Washer not loaded as recommended.	Remove several items and rearrange load evenly in washer drum. Close door; then touch and hold START/PAUSE.
		Do not add more than one or two additional items after cycle has started to avoid tightly packing or unbalancing.
Do not add more water to the washer.		
Not using HE detergent or using too much HE detergent.	Only use HE detergent. Suds from regular detergents can slow or stop the washer. Always measure detergent, following manufacturer's directions based on your load requirements.	
	To remove suds, cancel cycle. Select DRAIN & SPIN with EXTRA RINSE. Touch START/PAUSE. Do not add more detergent.	
	Make sure the Load & Go bulk dispenser is disabled if you are using a single dose of detergent.	
Door not opened between cycles.	After any wash cycle is completed, the door must be opened and then closed before a new cycle can begin.	
Washer not draining/spinning; loads are still wet	Drain hose extends into standpipe farther than 4.5" (114 mm).	Check drain hose for proper installation. Use drain hose form and securely attach to drainpipe or tub. Do not tape over drain opening.
	The drain hose is clogged, or the end of the drain hose more than 96" (2.4 m) above the floor.	Lower drain hose if the end is higher than 96" (2.4 m) above the floor. Remove any clogs from drain hose. See "Installation Requirements" in Installation Instructions.
	Strainer/stocking on end of drain hose.	Remove strainer/stocking from drain hose.
	The drain hose fits too tightly in the standpipe, or it is taped to the standpipe.	The drain hose should be loose yet fit securely. Do not seal the drain hose with tape. The hose needs an air gap. See "Secure the Drain Hose" in Installation Instructions.

# TROUBLESHOOTING

First try the solutions suggested here or visit our website at [www.whirlpool.com.tw](http://www.whirlpool.com.tw).

If you experience	Possible Causes	Solution
<b>Washer Not Performing As Expected (cont.)</b>		
Washer not draining/spinning; loads are still wet (cont)	Using cycles with a slower spin speed.	Cycles with slower spin speeds remove less water than cycles with fast spin speeds. Use the recommended cycle/speed spin for your garment.
	Washer not loaded as recommended.	A tightly packed or unbalanced load may not allow the washer to spin correctly, leaving the load wetter than normal. See the Cycle Guide for load size recommendation for each cycle.
	The load may be out of balance.	Avoid washing single items. Balance a single item, such as a rug or jeans jacket with a few extra items.
	Not using HE detergent or using too much HE detergent.	Use only HE detergent. Suds from regular detergent or using too much detergent can slow or stop draining or spinning. Always measure and follow manufacturer's directions for your load. To remove extra suds, select DRAIN & SPIN with EXTRA RINSE. Do not add detergent.
	Small items may have been caught in the pump or stuck between the washer drum and the outer tub.	Check the drum for any items sticking through the drum holes. Empty pockets and use garment bags when washing small items.
	There are too many clothes in the Wash & Dry cycle.	Only use the Wash & Dry cycle for two to four lightly soiled synthetic garments, athletic uniforms, or workout wear.
	One some models: Drain pump filter is dirty.	One some models: Clean drain pump filter. See "Cleaning the Drain Pump Filter/Draining Residual Water."
	Wash cycle has been canceled and door opened before water has drained.	Run Drain & Spin to remove any excess water.
Washer is spinning clothes without water	The washer is measuring the mass of the dry load.	This measurement is normal and ensures the best cycle time for your load.
Door locked at end of wash cycle	Water remaining in washer after cycle.	Select DRAIN & SPIN to remove any water remaining in the washer. The washer door will unlock at the end of the drain.
Door will not unlock	Door locks when cycle has started.	If the "Add Garment" light is lit, touch START/PAUSE once. The door will unlock.
Incorrect or wrong wash or rinse temperatures	Check for proper water supply.	Make sure hot and cold inlet hoses are not reversed.
		Both hoses must be attached to both washer and faucet, and have both hot and cold water flowing to inlet valve.
		Check that inlet valve screens are not clogged.
		Remove any kinks in hoses.
Washing many loads.	Your hot water tank may not have enough hot water to keep up with the number of hot or warm washes. This is normal.	
Desired setting or option does not light	For best performance, not all settings are available with each cycle, and some options cannot be used together.	See "Cycle Guide" for the available settings and options for each cycle.
Load not rinsed	Check for proper water supply.	Make sure hot and cold inlet hoses are not reversed.
		Both hoses must be attached and have water flowing to the inlet valves.
		Both hot and cold water faucets must be on.
		Inlet valve screens on washer may be clogged.
		Remove any kinks in the inlet hoses.
	Not using HE detergent or using too much HE detergent.	The suds from non-HE detergent can cause the washer to operate incorrectly. Use only HE detergent. Always measure detergent and follow manufacturer's directions based on load size and soil level.

# TROUBLESHOOTING

First try the solutions suggested here or visit our website at [www.whirlpool.com.tw](http://www.whirlpool.com.tw).

If you experience	Possible Causes	Solution
<b>Washer Not Performing As Expected (cont.)</b>		
Load not rinsed (cont.)	Washer not loaded as recommended.	Avoid tightly packing the washer. The washer will not rinse well if tightly packed. Load with dry items only. See "Cycle Guide" for load size recommendations for each cycle. Use cycle designed for the fabrics being washed. Add only one or two garments after washer has started.
	The load may be out of balance.	When load imbalance occurs, a washing process will start to redistribute the load. This may lengthen the cycle time. Avoid washing single items. Balance a single item, such as a rug or jeans jacket, with a few extra items.
Load is wrinkled, twisted, or tangled	Washer not loaded as recommended.	Add load loosely. Items need to move freely to reduce wrinkling and tangling. See "Cycle Guide" for load size recommendations for each cycle. Reduce tangling by mixing types of load items. Use the recommended cycle for the type of garments being washed.
	Wash action too long for load.	Select a lower soil level. Note that items will not be cleaned as deeply as when using a higher soil level.
	Spin speed too fast for load.	Select a slower spin speed. Note that items will be wetter than when using a faster spin speed.
	The washer is not unloaded promptly.	Unload the washer as soon as it stops or use FanFresh option if you will not be able to unload the washer at the end of the cycle.
	Not choosing the right cycle for the load being washed.	Use the Delicates cycle or another cycle with a slow spin speed to reduce wrinkling.
	The wash water was not warm enough to relax wrinkles.	If safe for load, use warm or hot wash water.
Not cleaning or removing stains	Washer not loaded as recommended.	Add load loosely. Items need to move freely for best cleaning. See "Cycle Guide" for load size recommendations for each cycle. Add only one or two garments after washer has started.
	Not using HE detergent or using too much HE detergent.	Use only HE detergent. Always measure detergent and follow manufacturer's directions based on load size and soil level.
	Hard water or high level of iron (rust) in water.	You may need to install a water softener and/or iron filter.
	Fabric softener dispensing ball used.	Dispensing balls will not operate correctly with this washer. Add liquid fabric softener to the fabric softener compartment.
	Powdered detergent used for slow-speed cycle.	Consider using liquid detergent.



# TROUBLESHOOTING

First try the solutions suggested here or visit our website at [www.whirlpool.com.tw](http://www.whirlpool.com.tw).

If you experience	Possible Causes	Solution
<b>Washer Not Performing As Expected (cont.)</b>		
Not cleaning or removing stains (cont.)	Not using correct cycle for fabric type.	Use a higher soil level setting and warmer wash temperature to improve cleaning.
		If using Quick Wash cycle, wash only a few items.
		Use Whites and Heavy Duty cycles for tough cleaning.
		Add an extra rinse for heavily soiled loads.
	Not using dispensers.	Use dispensers to avoid chlorine bleach and fabric softener staining.
		Load dispensers before starting a cycle.
		On some models: Make sure that the Load & Go bulk dispenser liquid detergent dispenser is not empty.
		Avoid overfilling.
Do not add products other than those specified directly to load.		
Dispense cartridge is empty.	Fill dispense cartridge to the "MAX" line with HE liquid detergent.	
Detergent dispenser is not securely in place.	Pull out the dispenser, fill with detergent, and slide it back in place.	
Not washing like colors together.	Wash like colors together and remove promptly after the cycle is complete to avoid dye transfer.	
Not enough detergent used, or hard water.	Use more detergent for washing heavy soils in cold or hard water.	
Odors	Monthly maintenance not done as recommended.	Run the Clean Washer with affresh cycle monthly or every 30 wash cycles. See "Washer Care" in the "Washer Maintenance" section.
		Unload washer as soon as cycle is complete. Use the FanFresh option if load cannot be removed immediately after the wash is complete.
	Not using HE detergent or using too much HE detergent.	Use only HE detergent. Be sure to measure correctly. Always follow the manufacturer's directions.
		See the "Washer Care" section.
Door not left open after use.	This washer has a tight seal to avoid water leaks. To avoid odors, leave the door open to allow the washer to dry between uses.	
Fabric damage	Sharp items were in pockets during wash cycle.	Empty pockets, zip zippers, and snap or hook fasteners before washing to avoid snags and tears.
	Strings and straps could have tangled.	Tie all strings and straps before starting wash load.
	Items may have been damaged before washing.	Mend rips and broken threads in seams before washing.
	Fabric damage can occur if washer is tightly packed.	Avoid tightly packing the washer. Load with dry items only.
		Use cycle designed for the fabrics being washed.
		Add only one or two garments after washer has started.
	Fabric damage can occur if washer door is closed on an item, trapping it between the door window and the rubber seal.	Do not overfill the washer.
		Push wash load fully into the washer.
	Liquid chlorine bleach may have been added incorrectly.	Do not pour liquid chlorine bleach directly onto load. Wipe up bleach spills.
		Undiluted bleach will damage fabrics. Do not use more than recommended by manufacturer.

# TROUBLESHOOTING

First try the solutions suggested here or visit our website at [www.whirlpool.com.tw](http://www.whirlpool.com.tw).

If you experience	Possible Causes	Solution
<b>Washer Not Performing As Expected (cont.)</b>		
Gray whites, dingy colors	Load not sorted properly.	The transfer of dye can occur when mixing whites and colors in a load. Sort dark clothes from whites and lights.
	Wash temperatures too low.	Use hot or warm temperatures if safe for the load. Make sure your hot water system is adequate to provide a hot water wash.
	Not enough detergent used, or hard water.	Use more detergent for washing heavy soils in cold or hard water.
Incorrect dispenser operation	Clogged dispensers or laundry products dispensing too soon.	Do not overfill dispenser. Overfilling causes immediate dispensing.
		Load dispensers before starting a cycle.
		Homes with low water pressure may result in residual powder in the dispenser. To avoid, select a warmer wash temperature if possible, depending on your load.
	Liquid chlorine bleach not used in bleach compartment.	Use only liquid chlorine bleach in the bleach compartment.
	Water in dispenser after cycle has finished.	It is normal for small amounts of water to remain in dispenser at the end of the cycle.
Single-dose laundry packet not dissolving	Adding laundry packet incorrectly.	Be sure laundry packet is added to washer drum before adding clothes. Do not add packet to dispenser. Follow the manufacturer's instructions to avoid damage to your garments.
Cycle time changes or cycle time too long	Normal washer operation.	The cycle times vary automatically based on your water pressure, water temperature, detergent, and clothes load. The options you select will also affect the cycle times.
	Excessive suds in washer.	When excessive suds are detected, a special suds routine automatically starts to remove extra suds and ensure proper rinsing of your garments. This routine will add time to the original cycle.
	Load may be out of balance.	When load unbalance occurs, a washing process will start to redistribute the load. This extends the cycle time. Avoid washing single items. Balance a single item such as a rug or jeans jacket with a few extra items.
	Not using correct cycle for load type.	The Quick Wash cycle is designed for smaller load sizes (2-4 items) of lightly soiled garments. If larger loads are washed in this cycle, cycle time will be increased.
When using the Quick Wash or Delicates cycle, you should wash small loads. This ensures a gentle wash for your garments without increasing cycle time.		
The controls are not responding	Control Lock is On.	Touch and hold CONTROL LOCK for 3 seconds to turn off Control Lock. For each second Control Lock is held down, the display will count down one second: you will see "3," then "2," then "1."

# TROUBLESHOOTING

First try the solutions suggested here or visit our website at [www.whirlpool.com.tw](http://www.whirlpool.com.tw).

If you experience	Possible Causes	Solution
<b>Drying Results</b>		
Clothes are not drying satisfactorily or drying times are too long	The load is too large and heavy to dry quickly.	Separate the load to tumble freely. Loading drum a quarter full or less will improve drying performance and cycle time. Run a high-speed spin cycle.
Lint on load	Area under door seal is clogged with lint.	Gently pull back the rubber door seal and clean lint with the textured side of an affresh Machine Cleaning Wipe.
	On some models: Drain pump filter is clogged with lint.	On some models: Clean the drain pump filter. See “Cleaning the Drain Pump Filter/Draining Residual Water.” This procedure should be performed occasionally.
Dried loads are wrinkled	The load was not removed from washer at the end of the drying cycle.	Remove garments promptly at the end of the drying cycle, or use the FanFresh option.
	The washer was tightly packed.	Dry smaller loads that can tumble freely. Loading drum a quarter full or less will improve drying performance and cycle time. Results may also vary depending on fabric type.
Load too hot	Load removed before cool-down portion of cycle is complete.	Allow the drying cycle to complete the cool-down portion of the cycle before removing the load. If you cancel the cycle before the cool-down portion of the cycle and immediately remove the load, it will be very hot.

---

## Assistance and Service

Before calling for assistance or service, please check the “Troubleshooting” section. It may help you save the cost of a service call. If you still need help, please follow the instructions below:

Before calling, please know the purchase date and the complete model and serial number of the washing machine. This information can help us to better respond to your request.

### **If you need replacement parts**

If you need to order replacement parts, we recommend that you only use factory-specified parts. These parts fit right and work right because they are manufactured to the same precise standards used to make each new Whirlpool product.

### **To locate original factory-specified parts in your area:**

Please directly contact the dealer who sold the washer, or contact Whirlpool company.

---

## IMPORTER INFORMATION

### **WHIRLPOOL (TAIWAN) CO., LTD.**

Customer Service toll free helpline: **0800 258 558**

Customer Service e-mail: [service\\_tw@whirlpool.com](mailto:service_tw@whirlpool.com)

Website: [www.whirlpool.com.tw](http://www.whirlpool.com.tw)