



User Manual

# Heritage Induction Pro Range

HIPR30S, HIPR36S

# Table of Contents

---

<b>Before You Begin</b>	<b>5</b>
Important Notes To the Owner	5
Energy-Saving Tips	5
About the Oven Vent	5
<b>Regulatory Notice</b>	<b>6</b>
<b>Important Safety Instructions</b>	<b>7</b>
Safety Symbols and Cautionary Information	7
Use-and-Care Safety Instructions	7
<b>Consignes de sécurité importantes</b>	<b>10</b>
Symboles de sécurité et informations de mise en garde	10
Consignes de sécurité d'utilisation et d'entretien	10
<b>Product Overview</b>	<b>13</b>
Included Accessories	13
External Features	13
Internal Features	14
Oven Control Panel	15
Oven Control-Panel Display	16
<b>Operating the Cooktop</b>	<b>17</b>
About Induction Cooking	17
Cooktop Layout	17
Getting Started	18
About the Cookware	18
Turning the Cooktop ON/OFF	19
Turning a Cook Zone ON/OFF	19
About Power Levels	20
Using Bridge Mode	21
About the Cooktop Timers	22
About Pause Mode	25
Using the Cooktop Lock System	26

# Table of Contents

---

<b>Operating the Oven</b>	<b>27</b>
Control-Panel Settings	27
About the Control-Panel "Beep"	27
Before Cooking	28
Positioning the Oven Racks	28
Running a Cook Cycle	29
About the Cook Modes	30
Bake-Mode Troubleshooting	31
Cooking Tips: Cook Modes and Cookware	32
About Oven Temperatures	33
Using Control Lockout	33
Using the Timers	34
Using Time-Delay Cooking	35
Using the Meat-Temperature Probe	36
Dehydrating/Defrosting Food	38
Using Proof Mode	38
Using Sabbath Mode	38
Adjusting the Oven-Temperature Offset	39
<b>Maintaining the Range</b>	<b>40</b>
General Exterior Maintenance	40
Maintaining the Cooktop	40
Using Self-Cleaning Mode	42
Steam-Cleaning the Oven	43
Cleaning the Oven Accessories	44
Replacing the Oven Lights	45
<b>Troubleshooting</b>	<b>46</b>
Cooktop	46
Oven-Control Display	46
Oven	47
<b>Warranty</b>	<b>48</b>
What Is Covered	48
What Is Not Covered	49
Out-of-Warranty Products	49



To Our Valued Customer:

Congratulations on your purchase of the very latest in Dacor® products! Our unique combination of features, style, and performance make us a great addition to your home.

To familiarize yourself with the controls, functions, and full potential of your new Dacor range, read this manual thoroughly, starting with **Before You Begin** (pg. 5).

Dacor appliances are designed and manufactured with quality and pride, while working within the framework of our company values. Should you ever have an issue with your range, first consult **Troubleshooting** (Pgs. 46 – 47), where you will find suggestions and remedies that may pre-empt a service call.

Valuable customer input helps us continually improve our products and services, so feel free to contact our Customer Assurance Team for assistance with all your product-support needs.

**Dacor Customer Assurance**

14425 Clark Avenue  
City of Industry, CA 91745

**Telephone:** 833-35-ELITE (833-353-5483) USA, Canada  
**Fax:** (626) 403-3130  
**Hours of Operation:** Mon – Fri, 5:00 a.m. to 5:00 p.m. Pacific Time  
**Website:** [www.dacor.com/customer-care/contact-us](http://www.dacor.com/customer-care/contact-us)

Thanks for choosing Dacor for your home. We are a company built by families for families, and we are dedicated to serving yours. We are confident that your new Dacor range will deliver top-level performance and enjoyment for decades to come.

Sincerely,

*The Dacor Customer Assurance Team*

# Before You Begin

---

## Important Notes to the Owner

---

- Electrical equipment can be dangerous. Thoroughly read the **Important Safety Instructions** (Pgs. 7 – 9) to minimize risk of property damage, personal injury, and death.
- Maintain the range as instructed in this manual.
- Keep this manual for personal and professional reference.
- Wipe down the range's exterior before its first use (see Pg. 37). Then, ventilate the kitchen well, remove all accessories from the oven chamber, and set the oven to Bake at 400°F (204°C) for 1 hour (see Pgs. 26, 31). A distinct odor during this process is normal.

## Energy-Saving Tips

---

- Leave the oven door closed when cooking (except to turn food), so the oven does not waste energy re-establishing the set cooking temp.
- If cooking ½ hour or longer, turn the oven off 5 – 10 minutes early to save electricity. Residual oven heat finishes cooking the food.
- Plan oven use to avoid turning the oven off between cooking tasks.
- When possible, cook multiple items together.

## About the Oven Vent

---

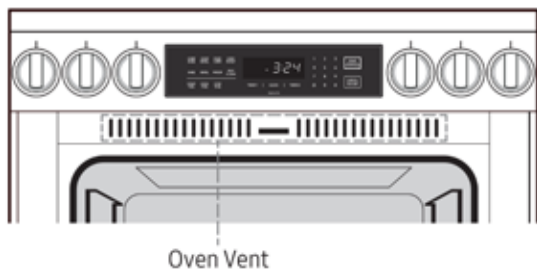

- The oven vent is above the oven chamber. (Open the door to view.) When the door is closed, air is drawn in through a vent at the bottom of the door, up within the door, out a corresponding vent in the top of the door into the vent you see at left, to cool the cooktop interior.
- Good air circulation ensures proper cooktop performance. Do not cover/block any part of the vent system.
- If the oven is on, be cautious near its door. Steam and hot air exiting the vents can burn skin and melt some items.

# Regulatory Notice

---

## 1. FCC (Federal Communications Commission) Notice

### CAUTION

Any modifications not expressly approved by the party responsible for compliance could void the user's authority to operate the equipment. This device complies with Part 15 of FCC Rules. Operation is subject to two conditions: 1) This device may not cause harmful interference; and 2) this device must accept any interference received, including that which causes undesired operation. For products available in the US/Canadian markets, only Channels 1 – 11 are available.

### FCC STATEMENT

This equipment was tested and found compliant within the limits for a Class B digital device, pursuant to Part 15 of FCC Rules. These limits are meant to reasonably protect against harmful interference in a residential installation. This equipment generates, uses, and can radiate radio-frequency energy, and, if not installed and used as instructed, may disrupt radio communications. However, interference may still occur in a given installation, which can be determined by turning the unit off and on. In case of disruption, the user should try to correct the interference by one or more of these measures:

- Reorienting or relocating the receiving antenna
- Increasing the separation between the equipment and receiver
- Connecting the equipment to an outlet on a different circuit than the radio/TV
- Consulting the dealer or an experienced radio/TV technician for help.

### FCC RADIATION-EXPOSURE STATEMENT

This equipment complies with FCC radiation-exposure limits set forth for an uncontrolled environment and should be installed/operated with at least 8" (20 cm) between the radiator and your body. This device and its antenna(s) must not be co-located or operated in conjunction with any other antenna or transmitter.

## 2. IC (Industry Canada) Notice

"IC" before the radio certification number signifies that Industry Canada technical specifications were met. Operation is subject to two conditions: 1) This device may not cause interference; and 2) this device must accept any interference received, including that which causes undesired operation. This Class B digital apparatus complies with Canadian ICES-003. For products available in the US/Canadian markets, only Channels 1 – 11 are available.

### IC RADIATION-EXPOSURE STATEMENT

The range complies with IC RSS-102 radiation-exposure limits set for an uncontrolled environment and should be installed/operated so there is at least 8" (20 cm) between the radiator and your body. This device and its antenna(s) must not be co-located or operated in conjunction with any other antenna or transmitter.

### General Safety Instructions

Testing found the range compliant with limits for a Class B digital device, pursuant to Part 18 of FCC rules. These limits are meant to reasonably protect against harmful interference in a home installation. The range generates, uses, and can radiate radio-frequency energy and, if not installed and used as directed, may harmfully impede radio communications; however, interference may still occur in a given installation. In case of disruption, which can be determined by turning the unit off and on, the user should try to correct the condition via one or more of these measures:

- Reorienting or relocating the receiving antenna
- Increasing the separation between the unit and receiver
- Connecting the equipment to an outlet on a different circuit than the radio/TV.



# Important Safety Instructions

---

## Safety Symbols and Cautionary Information

---

Electrical equipment can be harmful if handled improperly. The **Important Safety Instructions** (Pgs. 7 – 9) are meant to minimize the risk of property damage, personal injury, and death. Carefully follow these instructions.

SAFETY SYMBOLS/ALERTS	
 <b>WARNING</b>	Hazards/unsafe practices that may result in severe personal injury or death.
 <b>CAUTION</b>	Hazards/unsafe practices that may result in personal injury or property damage.
 <b>NOTE</b>	Useful tips and instructions

### About the Symbols In This Manual

The icons at left alert you to potentially unsafe conditions or helpful information.

### State of California Proposition 65 Warning

The range contains chemicals known to the State of California to cause cancer, and birth defects or other reproductive harm.

## Use-and-Care Safety Instructions

---

### **WARNING**

Read these instructions thoroughly to reduce the risk of property damage, personal injury, and death.

#### General Safety

- Do not touch any part of the range during or immediately after use.
- When the range is in its operating position, it must always engage the anti-tip bracket.
- Do not leave children unattended near the active range or let children sit/stand on any part of the range.
- Do not keep objects of interest to children on/above/near the range.
- Do not operate the range if it is damaged, malfunctioning, or missing parts.
- Do not heat sealed food containers; pressure buildup may burst the container and cause injury.
- Do not use oven cleaners or liners in/around the oven.
- To avoid steam burns, use dry potholders; do not let the potholder touch hot heating elements; do not use a towel or other bulky cloth as a potholder.
- Do not repair/replace any part of the range except as instructed in this manual; all other service must be performed by a qualified technician.
- Do not strike the oven-door glass.
- In disposing of the range, remove the power cord and door to avoid a safety hazard.
- Cook meat to an internal temperature of 160°F (71°C) and poultry to an internal temp of 180°F (82°C).
- Keep volatile substances (e.g., gasoline, alcohol, benzene) away from the range.

#### Fire Safety

- Do not store/place/use combustible items (e.g., paper, plastic, fabrics, gasoline) near the range.
- Do not wear loose-fitting or hanging garments/accessories while using the range.
- Keep flammable items away from active cooktop cook zones.
- Regularly clean the oven vents.
- (Cooktop fires) Do not douse a grease fire with water but turn off the cook zone, and if needed, use a multi-purpose, dry-chemical, or foam extinguisher.
- (Oven fires) Turn off the oven, and leave the door closed until the fire is out. If needed, use a multi-purpose, dry-chemical, or foam extinguisher.

# Important Safety Instructions

---

## Use-and-Care Safety Instructions, cont.

---

### **WARNING**

Read these instructions thoroughly to reduce the risk of property damage, personal injury, and death.

#### **Electrical and Grounding Safety**

- Do not use an adapter or extension cord.
- Do not use a damaged plug, cord, or loose power outlet, and do not alter the plug/cord/outlet.
- Do not put a fuse in a neutral or ground circuit.
- Use a dedicated 240 Vac, 60 Hz, 40 Amp breaker for the 36" range, and a 40 Amp breaker for the 30" range. A time-delay fuse or circuit breaker should be used. Plug only the range into this circuit.
- Ensure the range is properly grounded by a qualified electrician.
- The range's grounded, 3-prong plug must be inserted in a properly grounded 3-prong outlet. If codes allow a separate ground wire, a qualified electrician should determine its path. Do not connect the ground wire to plastic utility lines/pipes.
- Electrical service must follow local codes, or in their absence, the US National Electrical code/NFPA No. 70 – Latest Revision or, in Canada, the Canadian Electrical Code CSA C22.1 or Latest Revisions.
- The owner shall ensure the range receives the proper electrical service.

#### **Cooktop Safety**

- Cooktop cook zones should only be on when in use and should never be unattended.
- Do not line any part of the cooktop with foil.
- Put only cookware on the cooktop.
- Do not drag or drop cookware on the cooktop.
- Do not use rough-bottomed cookware.
- Food should only be flamed under an active ventilation hood.
- Only ferrous (iron-containing) cookware will work on the cooktop.
- The cook zones vary in size; select flat-bottom cookware large enough to cover the cook zone.
- Fry with minimal oil, heat the oil slowly, and watch as it heats; stand at a safe distance, and monitor the oil constantly; if combining oils, mix them before heating.
- Know the oil's smoke point; use a deep-fry thermometer to monitor the oil temperature.
- Do not fry frozen, icy, or overly cold food.
- Let the oil cool to room temperature before moving the cookware.
- In case of a burn injury, immerse the scalded area in cool water for at least 10 minutes, then cover with a clean, dry cloth; do not apply creams, oils, or lotions. Seek medical attention for severe burns.



# Important Safety Instructions

---

## Use-and-Care Safety Instructions, cont.

---

### **WARNING**

Read these instructions thoroughly to reduce the risk of property damage, personal injury, and death.



#### **Oven Safety**

- Do not use the oven for non-cooking purposes (ex: drying clothes, storage).
- Do not spray water on the door glass while the oven is on or still hot; do not use abrasive cleansers or metal scrapers to clean the glass.
- Do not clean the door gasket.
- Do not cover any part of the oven with foil or other material.
- Do not let grease build up in the oven.
- Always arrange oven racks when the oven is cool.
- Do not leave plastic in the oven.
- Keep the oven door closed while the oven is on.
- Do not put meat too close to the broil element; trim excess fat before cooking.
- Use cooking bags as directed by the bag manufacturer.
- If power fails during cooking, turn the oven off.
- Before self-cleaning, wipe excess residue from the oven, and remove all items, including racks.
- During self-cleaning, the oven operates at about 800°F (427°C); do not touch any part of the range during self-cleaning, and keep children away.
- If the oven malfunctions during self-cleaning, turn off the oven and circuit breaker, and contact a qualified service technician.
- Fumes released during self-cleaning can harm/kill birds. Move birds to a distant, well-ventilated room.
- When finished cooking, stand aside when opening the oven door to let steam/hot air escape safely.
- Do not use commercial oven cleaner or protective coating in the oven.

# Consignes de sécurité importantes

## Symboles de sécurité et informations de mise en garde

L'équipement électrique peut être dangereux s'il n'est pas manipulé correctement. Les consignes de sécurité importantes (pages 7 à 9) ont pour but de minimiser le risque de dommages matériels, de blessures corporelles et de mort. Suivez attentivement ces instructions.

SYMBOLES DE SÉCURITÉ / ALERTES	
 <b>ATTENTION</b>	Dangers/pratiques dangereuses pouvant entraîner des blessures graves ou la mort.
 <b>MIS EN GARDE</b>	Dangers/pratiques dangereuses pouvant entraîner des blessures ou des dommages matériels.
 <b>REMARQUE</b>	Conseils utiles et instructions

### À propos des symboles dans ce manuel

Les icônes à gauche vous signalent des conditions potentiellement dangereuses ou des informations utiles.

## Consignes de sécurité d'utilisation et d'entretien

### **ATTENTION**

Lisez attentivement ces instructions pour réduire les risques de dommages matériels, de blessures corporelles et de décès.

#### Sécurité générale

- Ne touchez aucune partie de la cuisinière pendant ou immédiatement après l'utilisation.
- Lorsque la cuisinière est dans sa position de fonctionnement, elle doit toujours s'engager dans le support antibasculement.
- Do not leave children unattended near the active range or let children sit/stand on any part of the range.
- Ne laissez pas les enfants sans surveillance à proximité de la cuisinière ou laissez les enfants s'asseoir / se tenir debout sur toute partie de la cuisinière.
- Ne pas utiliser la cuisinière si elle est endommagée, si elle fonctionne mal ou si des pièces manquent.
- Ne pas chauffer les contenants alimentaires scellés; accumulation de pression peut éclater le conteneur et causer des blessures.
- N'utilisez pas de nettoyeurs pour four ni de doublures dans / autour du four.
- Pour éviter les brûlures à la vapeur, utilisez des poignées sèches; ne laissez pas le manique toucher les éléments chauffants chauds; n'utilisez pas une serviette ou un autre chiffon volumineux comme poignée.
- Ne réparez / remplacez aucune partie de la cuisinière, sauf comme indiqué dans ce manuel; tous les autres services doivent être effectués par un technicien qualifié.
- Ne frappez pas le verre de la porte du four.
- Lors de la mise au rebut de la cuisinière, retirez le cordon d'alimentation et la porte pour éviter tout danger.
- Cuire la viande à une température interne de 160 ° F (71 ° C) et la volaille à une température interne de 180 ° F (82 ° C).
- Conservez les substances volatiles (par exemple, essence, alcool, benzène) à l'écart de la plage.

#### La sécurité incendie

- Ne pas stocker / placer / utiliser d'articles combustibles (par exemple, papier, plastique, tissus, essence) à proximité de la cuisinière.
- Ne portez pas de vêtements / accessoires amples ou suspendus lorsque vous utilisez la gamme.
- Garder les articles inflammables à l'écart des zones de cuisson actives de la table de cuisson.
- Nettoyer régulièrement les événements du four.
- (Incendies de la table de cuisson) Ne pas arroser un feu de graisse avec de l'eau mais éteindre la zone de cuisson et, si nécessaire, utiliser un extincteur à usages multiples, à poudre chimique ou à mousse.
- (Allume le four) Éteignez le four et laissez la porte fermée jusqu'à ce que le feu soit éteint. Si nécessaire, utilisez un extincteur à usage multiple, à poudre chimique ou à mousse.

# Consignes de sécurité importantes

---

## Consignes de sécurité d'utilisation et d'entretien, suite

---

### ATTENTION

Lisez attentivement ces instructions pour réduire les risques de dommages matériels, de blessures corporelles et de décès.

#### Sécurité électrique et de mise à la terre

- N'utilisez pas d'adaptateur ou de rallonge.
- N'utilisez pas une fiche, un cordon ou une prise électrique débranchés et ne modifiez pas la prise / le cordon / la prise.
- Ne pas mettre un fusible dans un circuit neutre ou au sol.
- Utilisez un disjoncteur de 240 Vca, 60 Hz, 40 A pour la gamme de 36" et un disjoncteur de 40 A pour la gamme de 30". Un fusible ou un disjoncteur à temporisation doit être utilisé.
- Assurez-vous que la cuisinière est correctement mise à la terre par un électricien qualifié.
- La fiche à trois broches mise à la terre de la gamme doit être insérée dans une prise à trois broches correctement mise à la terre. Si les codes permettent un fil de terre séparé, un électricien qualifié devrait déterminer son chemin. Ne pas connecter le fil de terre à des conduites / tuyaux en plastique.
- Le service d'électricité doit être conforme aux codes locaux ou, en leur absence, au Code national de l'électricité des États-Unis / NFPA no 70 - Dernière révision ou, au Canada, au Code canadien de l'électricité CSA C22.1 ou aux dernières révisions.
- Le propriétaire doit s'assurer que la cuisinière reçoit le bon service électrique.

#### Sécurité de la table de cuisson

- Les zones de cuisson ne doivent être allumées que lorsqu'elles sont utilisées et ne doivent jamais être laissées sans surveillance.
- Ne tapissez aucune partie de la table de cuisson avec une feuille.
- Mettez seulement des ustensiles de cuisson sur la table de cuisson.
- Ne faites pas glisser ou déposer des ustensiles sur la table de cuisson.
- N'utilisez pas d'ustensiles avec des fonds rugueux ou endommagés.
- Les aliments ne doivent être flambés que sous une hotte de ventilation active.
- Seule une batterie de cuisine ferreuse (contenant du fer) fonctionnera sur la table de cuisson.
- Les zones de cuisson varient en taille; utiliser des ustensiles de cuisson qui correspondent à la zone de cuisson.
- Faire frire avec un minimum d'huile, chauffer l'huile lentement et regarder pendant qu'elle chauffe; se tenir à une distance sécuritaire et surveiller constamment l'huile; Si vous combinez des huiles, mélangez-les avant de chauffer.
- Connaître le point de fumée de l'huile; utiliser un thermomètre à friture pour surveiller la température de l'huile.
- Ne faites pas frire de la nourriture congelée, glacée ou trop froide.
- Laissez l'huile refroidir à température ambiante avant de déplacer les ustensiles de cuisson.
- En cas de brûlure, immergez la zone échaudée dans de l'eau fraîche pendant au moins 10 minutes, puis couvrez avec un chiffon propre et sec; ne pas appliquer de crèmes, d'huiles ou de lotions. Consulter un médecin pour les brûlures graves.

# Consignes de sécurité importantes

---

## Consignes de sécurité d'utilisation et d'entretien, suite

---

### ATTENTION

Lisez attentivement ces instructions pour réduire les risques de dommages matériels, de blessures corporelles et de décès.

#### Sécurité du four

- Ne pas utiliser le four à des fins autres que la cuisson (ex: séchage des vêtements, entreposage).
- Ne vaporisez pas d'eau sur la vitre lorsque le four est allumé ou encore chaud. n'utilisez pas de nettoyeurs abrasifs ou de grattoirs métalliques pour nettoyer le verre.
- Ne pas nettoyer le joint de la porte.
- Ne recouvrez aucune partie du four d'une feuille ou d'un autre matériau.
- Ne laissez pas la graisse s'accumuler dans le four.
- Toujours ranger les grilles du four lorsque le four est froid.
- Ne laissez pas de plastique dans le four.
- Gardez la porte du four fermée lorsque le four est allumé.
- Ne pas mettre la viande trop près de l'élément du gril; couper l'excès de graisse avant la cuisson.
- Use cooking bags as directed by the bag manufacturer.
- Si la puissance tombe en panne pendant la cuisson, éteignez le four.
- Avant de procéder à l'auto-nettoyage, essuyez les résidus excédentaires du four et retirez tous les articles, y compris les supports.
- Pendant l'autonettoyage, le four fonctionne à environ 427 ° C (800 ° F); ne touchez aucune partie de la cuisinière pendant l'auto-nettoyage et éloignez les enfants.
- Si le four ne fonctionne pas correctement pendant l'auto-nettoyage, éteignez le four et le disjoncteur et contactez un technicien qualifié.
- Les vapeurs dégagées lors de l'auto-nettoyage peuvent endommager / tuer les oiseaux. Amenez les oiseaux dans une pièce éloignée et bien ventilée.
- Une fois la cuisson terminée, mettez-la de côté lorsque vous ouvrez la porte du four pour laisser la vapeur ou l'air chaud s'échapper en toute sécurité.
- N'utilisez pas de nettoyeur commercial pour four ou de revêtement protecteur dans le four.

# Product Overview

## Included Accessories



GlideRack™ Oven Rack (2)



Standard Oven Rack (1)



Anti-Tip Bracket w/Screws and Anchors



Temperature Probe

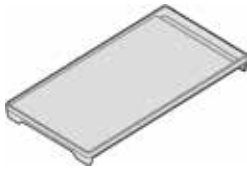

Griddle



Broiler Pan and Grill



Stainless-Steel Cleaner



Literature Kit

## External Features

HIPR36S model shown

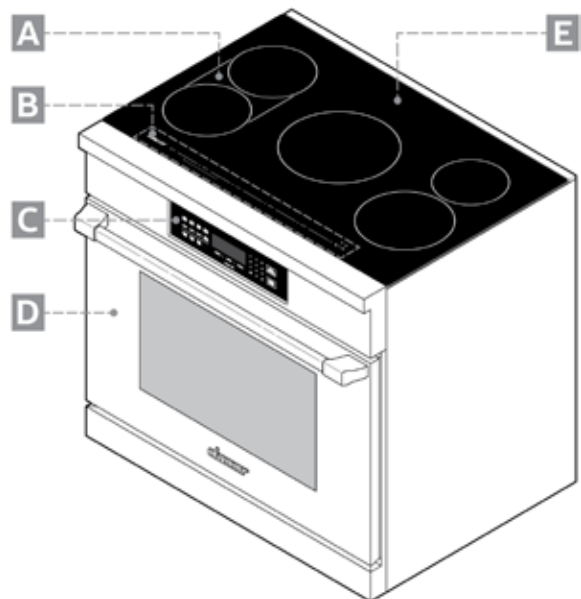

Callout	Description
A	Bridge zone (left-side front/rear cook zones function in tandem for rectangular dishes and griddle)
B	Rangetop control panel
C	Oven control panel
D	Removable oven door
E	Induction rangetop

# Product Overview

## Internal Features

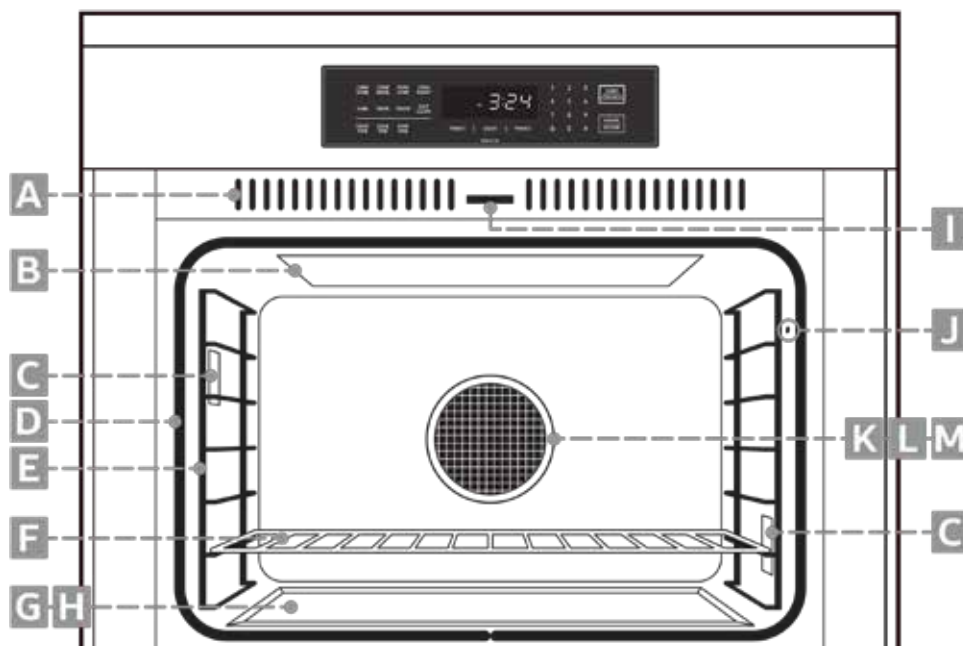

CONTROL-PANEL FEATURES		
Callout	Name	Description
A	Air-Intake Grill	Air is drawn through horizontal slot (not shown) below door and up within door, then out grill at top of door through this grill to cool internal cooktop parts; keep slot and grills clear.
B	Broil Element	Inside oven ceiling behind glass panel; top heat source.
C	Oven Lights	Two 12V, 20W halogen bulbs illuminate oven chamber from left/right sides; tap Light icon (control panel) to turn lights on/off.
D	Oven-Door Gasket	Keeps heat from escaping when door is closed.
E	Rack Support	Install GlideRack and standard racks on these supports; rack levels 1 (bottom) to 7 (top)
F	Oven Rack	2 GlideRack™ oven racks and 1 standard rack are provided. (See Pgs. 10, 25.)
G	Bake Element	Below oven-chamber floor; bottom-heat source.
H	Oven-Floor Recess	Add water here for steam-cleaning cycle. (See Pg. 40.)
I	Self-Cleaning Latch	During self-cleaning, the latch keeps oven door lock for safety.
J	Temp-Probe Outlet	Insert meat-temperature probe plug here. (See Pg. 33.)
K	Convection Fan	(From behind filter) Circulates air in oven during convection cooking.
L	Convection Element	(From behind filter) Heats air blown into oven by convection fan during convection cooking; rear heat source.
M	Convection Filter	Clips onto crossbar over hole in oven wall; keeps fan from blowing particulates into oven chamber; keeps user safe from fan blades.

# Product Overview

## Oven Control Panel

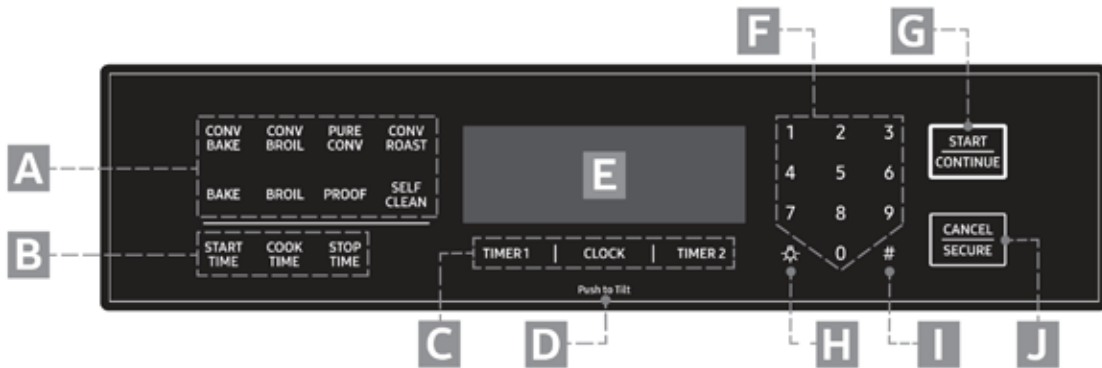

OVEN CONTROL-PANEL FEATURES		
Callout	Name	Description
A	Operation-Mode Keys	Tap a key to select an operation mode (e.g., cooking, dough proofing, self-cleaning).
B	Time-Delay Cooking Keys	Set oven to turn on/off automatically (see Pg. 32).
C	Clock/Timer Keys	Clock: Sets clock (see Pg. 24); TIMER 1, 2: Use timing a food prep/cooking task; timers work independently; can be used when oven is off; timers do not turn oven on/off (see Pg. 31).
D	Push to Tilt	Press here, and spring-loaded control panel slowly rotates upward 50° for easier viewing; push here again until panel clicks into its original position.
E	Display	Shows time of day and oven operations (see next page).
F	Numeric Keypad	Sets cook temperature, cook time, time of day.
G	START/CONTINUE	Select a cook mode (A), then tap this key to start cooking; this key starts timers after you set a cook time and resumes cook time after a pause.
H	Oven-Light Key	Turns oven light on/off.
I	Sabbath Mode Key	Activates Sabbath mode (see Pg. 35).
J	CANCEL/SECURE	Turns off oven, zeroes out all temperature settings, turns off active features (except timer), activates control lock-out.

# Product Overview

## Oven Control-Panel Display



OVEN CONTROL-PANEL-DISPLAY FEATURES		
Callout	Name	Description
A	Cook-Mode Icons	From left: Convection, Bake, Broil, Roast; these appear, sometimes in combination, according to selected cook mode.
B	Oven On Indicator	Appears when oven is in use.
C	AM-PM Indicator	One of these appears according to time of day.
D	Clock-Mode Indicator	Appears when military-time mode is selected (absent when standard mode is selected).
E	Clock/Timer Readout	Shows time remaining on selected timer or time of day if no timer is selected.
F	Meat-Temp-Probe Icon	Appears when temperature-probe mode is active.
G	Preheating Indicator	Appears when oven is preheating (disappears when oven-temperature setting is reached).
H	Oven-Temperature Readout	Shows oven temperature-scale setting: °F or °C.
I	Time-Delay Indicator	Appears when delay-time cooking is active.
J	Control-Lockout Icon	Appears when control-lockout is active.
K	Cook-Time Indicators	START: Appears if a start time is set for a cook task; readout (E) shows time of day when oven will start cooking; DURATION: Appears if you tap COOK TIME after setting a stop time for a cook task; readout (E) shows cook-time countdown; STOP: Appears if a stop time is set for a cook task; readout (E) shows time of day when cooking will stop.
L	Clock-Set Icon	Appears after CLOCK is tapped when setting current time.
M	Timer Indicators	These appear depending on timer use; if both timers are active, both indicators appear.
N	Cleaning Icon	Appears when self-cleaning or steam cleaning the oven.



# Operating the Cooktop

## About Induction Cooking

COMPATIBLE/INCOMPATIBLE COOKWARE*	
Compatible	Incompatible
Stainless Steel (for induction)	Regular steel
Enameled Steel	Copper
Cast Iron	Aluminum
Cookware labeled "Induction Compatible"	Glass
	Ceramic

\*If unsure that a piece of cookware is induction-compatible, touch a refrigerator magnet to its base. If the magnet sticks, the cookware is induction-compatible.

The induction cooktop heats food via a magnetic reaction between the cookware and cooktop heating element. This reaction is confined to the area directly under the pan, making it the only part of the cooktop that gets hot; thus, induction cooking is safer and more efficient than traditional thermal conduction: 90% of induction energy is used to cook food compared to 55% for gas and 65% for electricity.

Another advantage to induction cooking is the ability to instantly and precisely change heating levels. This is especially desirable for foods that are ruined if only slightly overheated (ex: chocolate). Also, food can be kept at a constant heat level over time; whereas, gas- and electric-conduction settings increase over time.

## Cooktop Layout

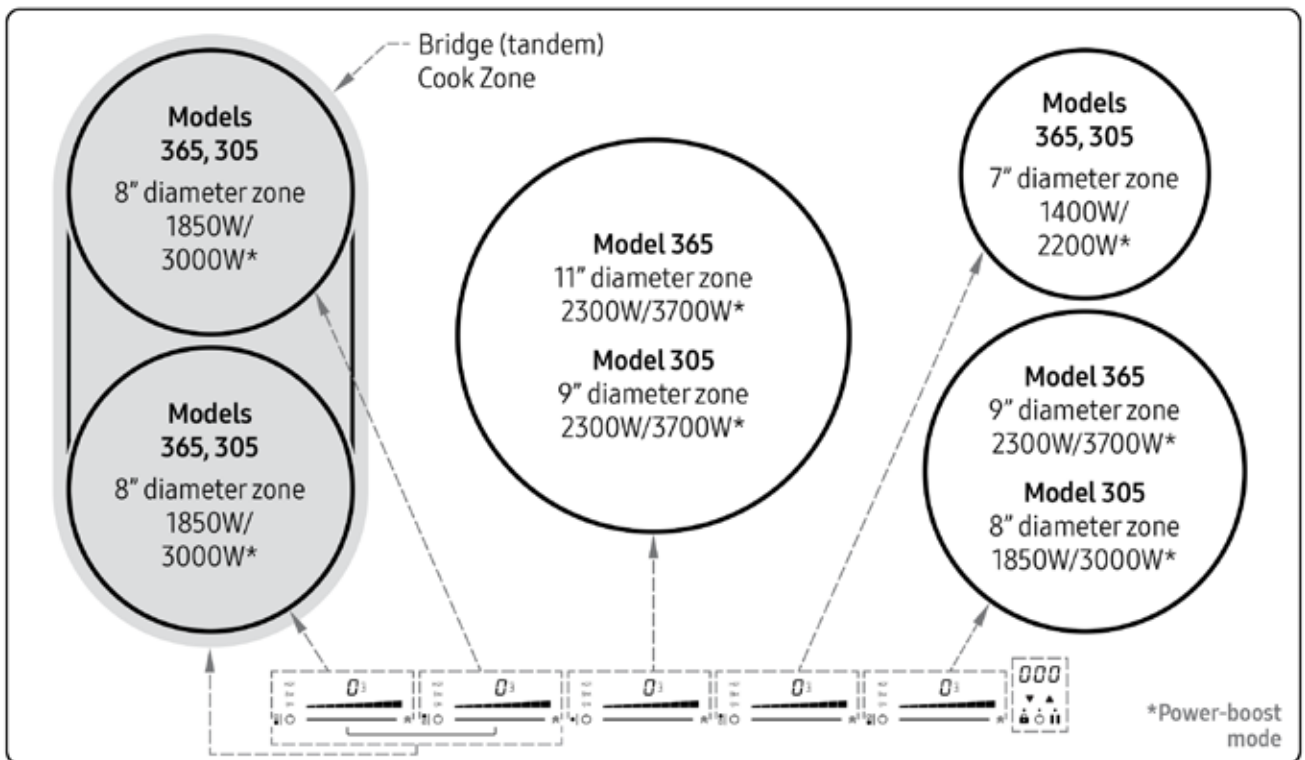

### NOTE

- All power elements have a temperature limiter under the glass; the limiter manages cook-zone power to prevent overheating.
- It is normal for an active cook-zone power element to emit soft clicking sounds. The rhythm of these clicks varies with the power-level settings.

# Operating the Cooktop

## Getting Started

- After removing packing material, wipe the cooktop with a damp sponge, then dry it with a soft cloth.
- Initially there may be a slight burning odor or light smoke. These conditions are normal and vanish quickly.
- Experiment with power levels to decide the best level for your cooking needs and style; note the setting that works best for a specific food/recipe.
- Cookware distributes heat (via electro-magnetic energy) based on material and sturdiness, so the same food may have slightly different cook times in similar cookware from different manufacturers.

## About the Cookware

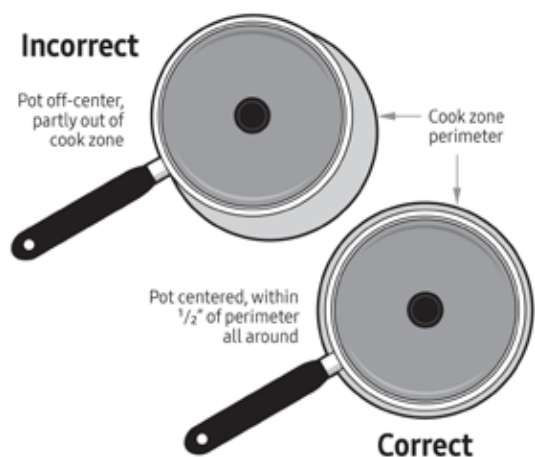

### ⚠ WARNING

Cookware diameter should be large enough to cover the cook zone within 1/2" over or under. Undersized or poorly placed cookware exposes part of the heating element, which reduces heating efficiency.

- Only cookware constructed of magnetic material (see table, previous page) can be used on the cooktop. Cookware specifically designed for induction cooking is typically marked with  (on the bottom).
  - Non-magnetic cookware will not heat food and may cause vibration or activate the "No Pan Detected" indicator. (See **About Pan Detection**, below.)
  - Use tight-fitting lids to retain heat and avoid spills.
- Use cookware that can accommodate the quantity of food being prepared.
  - Use only clean, undamaged cookware with flat, smooth bottoms that will not scratch the glass cooktop.
  - Use the bridge zone for griddles or rectangular/oblong cookware that cover multiple cook zones.

## About Pan Detection

Active cook zones will not heat unless induction cookware is in the zone. If you turn ON a cook zone and set a heat level, but: a) no cookware is present, b) the cookware is not centered in the zone, or c) you remove the cookware you placed in the cook zone without turning OFF the zone, a certain symbol (depending on the setting) appears in the digital readout above the heat-level ramp, indicating that no cookware is detected.



### Simmer Level

If you set a heat level at **Simmer** but no pan is present, a U-shaped symbol (representing the cross-section of a pan) "bobs" up and down on the digital readout, signalling that no cookware is detected.



### Power Levels 1 to Boost

If you set a cook-zone power level from **1** to **Boost** but no pan is present, a U-shaped pan symbol alternates with the setting number (or letter "b" when in Boost mode) on the readout, signalling that no cookware is detected.

# Operating the Cooktop

## Turning the Cooktop ON/OFF

You can turn the cooktop on without cookware on a cook zone. Power is applied after the cookware is in place.

### ⚠ WARNING

- Metallic objects (e.g., utensils, lids, cans) left on the cooktop can heat to unsafe temperatures and may warp.
- The glass around the cook zones cannot be heated by the cooktop controls; however, it can still heat to an unsafe temperature if hot cookware is placed on it.

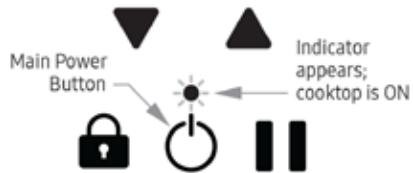

- \* Press the main power button (1-2 seconds). The main-power indicator appears; the cooktop is on.
- Push the main power button to turn OFF all cook zones simultaneously.
- If you press the main power button but do not activate a cook zone within 10 seconds, the cooktop shuts off.
- If you press the main power button and activate a cook zone but do not set a power level within 10 seconds, the zone shuts off; if you take no further action within 10 seconds, the cooktop shuts off.
- If you mistakenly push the main power button while any cook zones are active, press it again within 5 seconds to restore all previous settings.
- If a cook zone is on for an extended period (period varies with the power setting) and control settings are unchanged, the cooktop shuts off; the HOT indicator stays on until the cooktop is safe to touch.

## Turning a Cook Zone ON/OFF

### 📖 NOTE

- Before cooking, always clean the cooktop (especially the controls) to ensure proper function.
- While cooking, you can change the power level any time.

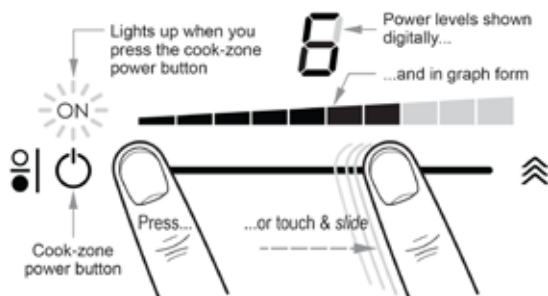

1. Center a pan on a cook zone (see **About Pan Detection**, Pg. 15), and press the cook-zone power button. The "ON" indicator appears; the zone is active.
2. Move your finger along the slider (right, to increase; left, to decrease); at the desired level, remove your finger.
3. When finished, press the cook-zone power button. The "ON" indicator goes out; the cook zone is off. (The zone is unsafe to touch until the HOT indicator goes out.)

# Operating the Cooktop

## About Power Levels

Type of Cooking	Power Level	No. Ramp Bars
Rapid heat/rolling boil	Boost	10
Lower-level boil	4 to 9	5 to 10
Frying	5 and 6	6 or 7
General cook/sear	3 to 9	4 to 10
Keep warm*	Simmer to 2	1 to 3
Melting chocolate	1	2
Simmer	Simmer	1

\*To avoid bacterial growth, keep temps above 140°F (60°C).

The induction cooktop cooks food based on power levels (Simmer, Levels 1 – 9, and Boost), similar to gas and electric models. A power level's effectiveness varies slightly with the cookware brand, type, size, structure, and degree of magnetism. Experiment to determine the best levels for your own cookware.

### NOTE

Because various cookware traits influence cooking temperatures, temp equivalents for each power level are not given.

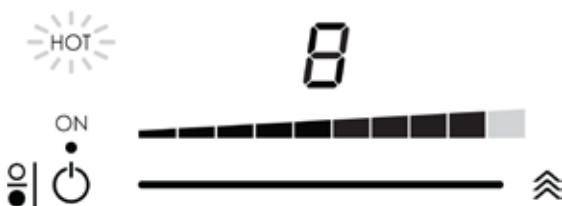

### About the HOT Designator

Once a cook zone becomes hot enough to burn skin, the zone's HOT designator appears and remains as long as the cook zone is too hot to touch safely (even if you turn OFF the cook zone).

### Using Simmer Level

Simmering cooks food (ex: soup, stew, chili, stock) slowly in liquid near but below the boiling point.

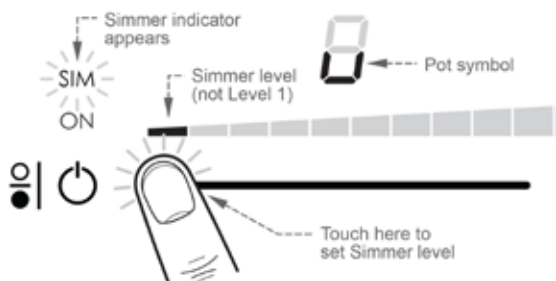

1. Tap a cook-zone power button.  
The "ON" indicator appears; the zone is active.
2. Tap the left end of the slider.  
The first bar on the power-level ramp appears; the U-shaped pot symbol appears above the ramp; SIM appears on the panel, indicating the zone is at Simmer level.

### NOTE

The first bar on the ramp is Simmer level, not Power Level 1. (The second bar is Power Level 1.)

### Using Power Levels 1 – 9

These levels represent a graduated increase in cooking power from "low" to "medium" to "high" heat.

### WARNING

Do not fry foods above Level 6; any higher level will likely cause cooking oils to smoke or ignite.

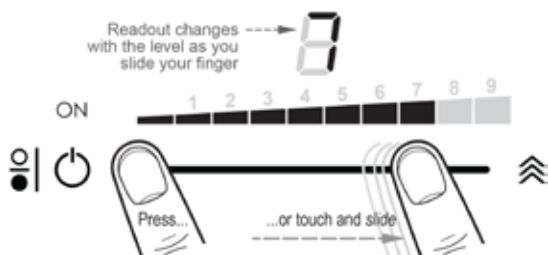

1. Place the cookware on a cook zone, and turn the zone on.
2. Touch the slider at any point, then move your finger to the desired power level.  
The level appears digitally on the readout and in bar form on the power-level ramp.
3. At the desired power level, remove your finger.  
A clicking sound signals that the zone is heating the food.

# Operating the Cooktop

## About Power Levels, cont.

### About Boost Mode

This mode quickly maximizes the cook-zone power level to rapidly boil liquids or sear meats, among other uses.

#### NOTE

- You can set Boost mode for three cook zones at a time: One left-side zone, the center zone, and one right-side zone; you cannot set both zones on either side at once (thus, bridging is not available in Boost mode).
- Boost mode raises the power about 60% above Level 9 for 10 minutes, then reduces power to Level 9 to prevent overheating. (You may restart Boost mode when the power condition allows.)

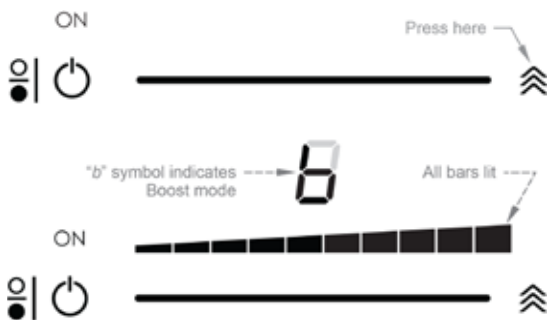

1. Press a cook-zone power button.  
The "ON" indicator appears; the zone is active.
2. Press the Boost button (right end of slider).  
The display changes to "b"; all ramp bars are lit.

## Using Bridge Mode

You can combine (bridge) the left-hand front/rear cook zones (see Pg. 14) to receive a griddle or oblong cookware. On the cooktop, a horizontal bracket indicates which control panels combine for bridge mode.

The power level and timer for the two cook zones are shared; the left-most cook-zone control panel becomes the master control (i.e., the bridge power level is regulated/displayed on the left-most control panel).

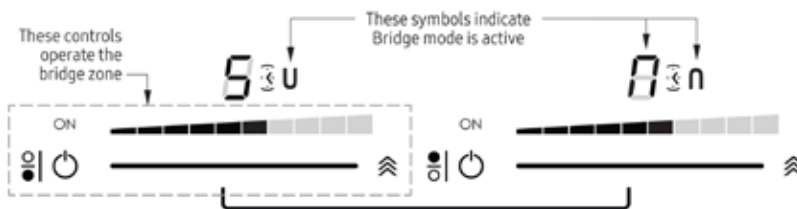

1. Press-hold the main power button (1-2 seconds).  
The main-power indicator appears; the cooktop is on.
2. Press the left-front and left-rear cook-zone power buttons.

3. Simultaneously touch-hold the left-front and left-rear sliders.  
The two cook zones enter bridge mode; bridge symbols appear on the control panel; the left-front control becomes the master bridge control. (See the above graphic.)
4. Set the bridge power level by moving your finger along the master bridge control (left-hand) slider.

#### NOTE

- The timer icon displays on both bridge zones.
- If no pan is detected on either zone within 10 minutes, bridge mode de-activates.
- If the pot does not cover both cook zones, bridge mode de-activates after 10 minutes. (The cook zone under the pot remains active at the set power level; the empty zone shuts off.)
- The Boost function is unavailable in Bridge mode.

# Operating the Cooktop



## About the Cooktop Timers

The cooktop has seven alarm timers: one for each cook zone (including the bridge), and one timer unassociated with a cook zone (thus, cook-zone power is not turned off when this alarm sounds).

### NOTE

- If timers are set for multiple cook zones, the main control panel displays the timer that will go off first, and that zone's timer icon glows brightly. (The other timer icons are dim but visible.) When one cook-zone timer goes off, its timer icon goes out, and the timer icon for the next cook zone in line brightens.
- The up-arrow on the main control panel adds time; the down-arrow subtracts time.
- Press the up/down arrow buttons simultaneously to pause the timer display; countdown resumes automatically in 5 seconds.
- When a cook zone reaches its set time, a double-beep alarm sounds until you press the up or down arrow. If the alarm is not silenced manually, it shuts itself off two minutes later.

## About the Main-Timer Display

Timer Display Readings		
Image	Time	Description
	1 min to 9 min	Press ▲ 1 to 9 times; each press adds 1 minute
	10 min to 59 min	Press-hold ▲ to set longer times
	1 hr to 1 hr, 59 min	Press-hold ▲ to set time (max. time: 1 hr, 59 min.)

Timer formats on the main control-panel depend on the time setting. The "dot" (Image column, left) blinks to show time is counting down and continues until the display goes out as the alarm sounds. It divides min/sec (Image column, top row) and hr/min (Image column, bottom row). For settings of 10+ minutes, seconds do not appear, and the MIN designator is lit. (Seconds appear when the countdown falls below 10 min.)

# Operating the Cooktop

## About the Cooktop Timers, cont.

### Setting the Cooktop Timers

Press Pause to stop/resume timer countdown if needed. Countdown continues even if the pan is removed.



#### Setting a Cook-Zone Timer

1. Press-hold the main power button (1 – 2 seconds until the indicator appears).
2. Press the cook zone power button, and set the power level. (If needed, see **Turning a Cook Zone ON/OFF**, Pg. 16)
3. (Main control panel) Simultaneously press-hold ▼ and ▲. The timer display activates.
4. Tap ▲ repeatedly until the desired cook time appears. Countdown starts 5 seconds after you stop tapping ▲.

Cook-Zone Timer		
Feature	Name	Description
A	Cook Zone Timer Icon	Appears while timer is active
B	Timer Display	Shows time remaining (in this case, 53 min.)
C	Blinking Dot	Blinks to indicate time is counting down; separates hr/min, min/sec
D	MIN Indicator	Appears for all time settings of 10+ minutes
E, F	Down-/Up-Arrow	Press simultaneously to activate timer; press either arrow repeatedly to set time



#### Setting the Independent-Alarm Timer (Main Control)

This timer is for timing kitchen tasks apart from cooktop use.

1. (Main control panel) Simultaneously press-hold ▼ and ▲. The timer display activates; the timer icon appears between the up-/down-arrows.
2. Tap ▲ repeatedly until the desired cook time appears.

Independent Timer		
Feature	Name	Description
A	Timer Display	Shows time remaining (in this case, 1 hr.-46 min.)
B	Blinking Dot	Blinks to indicate time is counting down; separates hr/min, min/sec
C	MIN Indicator	Appears for all set times of 10+ minutes
D, F	Down-/Up-Arrow	Press simultaneously to activate timer; press either arrow repeatedly to set time
E	Independent Timer Icon	Appears while timer is active

# Operating the Cooktop

---

## About the Cooktop Timers, cont.

---

### Setting the Cooktop Timers, cont.

#### Adjusting an Active Timer

Once you set a timer (for a cook zone or independent timing task), you can adjust the time as needed.

#### NOTE

On the main display, you can press an arrow button repeatedly (for small adjustments), or you can press-hold an arrow (for large adjustments) to rapidly adjust the time. When holding the up-arrow, the numbers increase 1 minute at a time; when holding the down-arrow, the numbers decrease 10 seconds at a time.

1. (Main control panel) Simultaneously press-hold ▼ and ▲.  
The timer-display countdown pauses.
2. Tap the appropriate arrow repeatedly, until you reach the desired time.  
Countdown resumes from the newly set time.

#### Checking the Time On Another Cook Zone

If you have set cook times on multiple zones, the main control panel shows the time for the zone with the least time remaining. This procedure instructs you how to check the time remaining on the other cook zones.

1. (Main control panel) Simultaneously press-hold ▼ and ▲.  
The displayed time changes to the zone with the most recently set time; that zone's timer icon brightens. (All other icons are dimmed.)
2. Simultaneously press-hold ▼ and ▲ again to view the time for the next most recently set zone.  
The displayed time changes to that zone, and its timer icon brightens while all others are dimmed.

#### Manually Turning Off the Timer

No button instantly turns off the timer. Use this procedure to turn off a timer before the set time runs out.

1. (Main control panel) Simultaneously press-hold ▼ and ▲.  
The timer countdown pauses.
2. Press-hold ▼ until the display reads zero, and remove your finger.  
In 5 seconds the timer display and cook-zone timer icon go out.



# Operating the Cooktop

## About Pause Mode

After setting the power level on one or more cook zones, you can interrupt operations via the Pause button on the main control panel. (This procedure starts after you have set one or more cook zones.)

### NOTE

- After 10 minutes in Pause mode, the cooktop shuts off. (All previous settings are lost.)
- All alarm timers stop when you enter Pause mode and resume when you **manually** leave Pause mode.

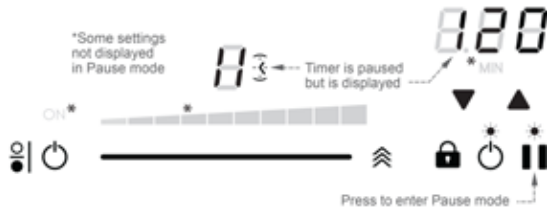

1. (Main control panel) Tap Pause.  
The Pause symbol appears on the digital readouts of all cook zones (active or inactive); no heating occurs in any cook zone.

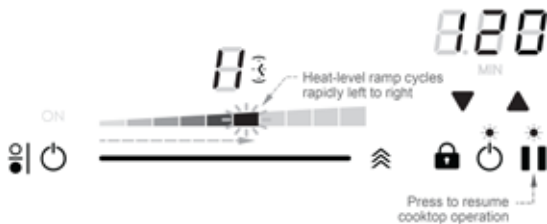

2. Tap Pause again.  
The power-level ramp on the right-front cook zone control panel cycles rapidly left to right.

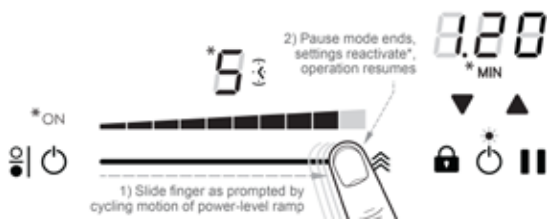

3. Within 10 seconds, move your finger left to right along the slider as prompted by the ramp.  
As your finger reaches the right end of the slider, a click signals the exit from Pause mode.  
(If you do not perform Step 3 within 10 seconds of Step 2, Pause mode remains active.)

# Operating the Cooktop

## Using the Cooktop Lock System

The cooktop lock system consists of Key Lock and Child Lock modes.

### Using Key Lock Mode

This mode prevents unintended changes to cook zone settings. Only the cook-zone power (OFF) button and alarm (OFF) function are active.

#### NOTE

You can activate any timer before setting Key Lock mode.

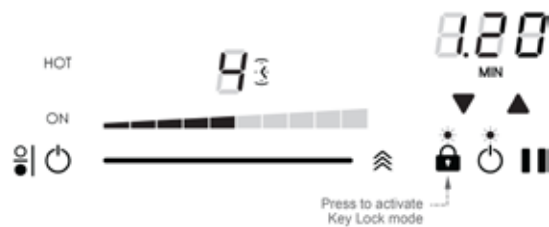

#### Activating/De-activating Key Lock Mode

1. Turn on and set the power levels of one or more cook zones.
2. Press the Key Lock icon.  
Key Lock mode is active; you cannot activate cook zones or change settings on active zones.
3. Press the Key Lock icon.  
Key Lock mode is inactive; you can activate cook zones and change settings on active zones.

### Using Child Lock Mode

This mode keeps unauthorized users from turning on the cooktop. Activate Child Lock mode after turning on the main control but before activating any cook zones.

#### NOTE

- You can only set the main alarm timer before activating Child Lock mode.
- In Child Lock mode, all cook-zone control panels display an L (locked) symbol for 10 seconds, and cook-zone HOT indicators remain until the zones are safe to touch.



#### Activating/De-activating Child Lock Mode

1. De-activate all cook zones.
2. For 4 seconds, simultaneously press-hold Lock and Pause.  
Child Lock mode is active; all cook-zone controls are inactive.
3. For 4 seconds, simultaneously press-hold Lock and Pause.  
Child Lock mode is inactive; you can activate cook zones.

# Operating the Oven

---

## Control-Panel Settings

---

### Setting the Clock

1. On the control panel, tap **CLOCK**.  
The colon between the minutes and seconds blinks.
2. On the numeric pad, enter the current time.  
Ex: Tap 1-2-0-8 for 12:08.
3. Tap **#**, and set **AM** or **PM**.
4. Tap **START** or **CLOCK**.  
The colon stops blinking; the time of day is set.

### **NOTE**

- After tapping **CLOCK**, perform Steps 2 – 4 within 6 seconds or the previously set time reappears.
- During time-delay cooking, the clock cannot be set if a timer, Self-Cleaning, or Sabbath mode is active.
- When power resumes after an outage, the time display flashes, reminding you to reset the time.

### Switching to Military Time (24-hr Clock)

The default is standard, 12-hr time. Military time is a 24-hr system (ex: 13:37 instead of 3:37 p.m.).

1. Tap-hold **CLOCK** for 6 seconds.  
The display shows the time in standard mode.
2. On the numeric pad, tap **#**.  
The clock display switches to military (24-hr) mode.
3. Tap **CANCEL/SECURE**.  
The main display shows the time in military mode.

### Setting the Temperature Scale

Fahrenheit (default) and Celsius are available.

1. On the control panel, tap-hold **BROIL** for 6 seconds.  
The current temp scale appears on the display.
2. On the numeric pad, tap **#**.  
The display shows the selected temperature scale (**F** or **C**).
3. Tap **CANCEL/SECURE**.  
The selected temperature scale is set.

## About the Control-Panel "Beep"

---

The control panel beeps: 1) if you tap a key, 2) when a timer reaches zero, 3) if there is an error, and 4) when the oven performs certain set functions. You can silence/activate the beep as desired.

1. On the control panel, tap-hold **START TIME** for 6 seconds.  
"Beep" appears on the display.
2. On the numeric pad, tap **#** > **CANCEL/SECURE**.  
The beep is enabled/disabled.

# Operating the Oven

---

## Before Cooking

---

- Before using the oven for the first time, ventilate the kitchen well, remove all accessories from the oven, and set it to Bake at 400°F (204°C) for 1 hour (see Pgs. 26, 31). This process burns off manufacturing residue and removes undesirable odors that would otherwise be emitted the first few occasions of normal use.
- When baking/roasting, the oven preheats automatically. Preheating time varies with the temperature setting and your home's electrical supply. Preheating cannot be used for broiling.

### CAUTION

To avoid marring the oven's porcelain finish, quickly wipe up acidic foods (e.g., citrus, tomato, pineapple).

## Positioning the Oven Racks

---

You may use either rack type (standard or GlideRack™) on any rack level.

### WARNING

Handle the racks only when the oven is cool. If you must reposition a rack when the oven is hot, use oven mitts.

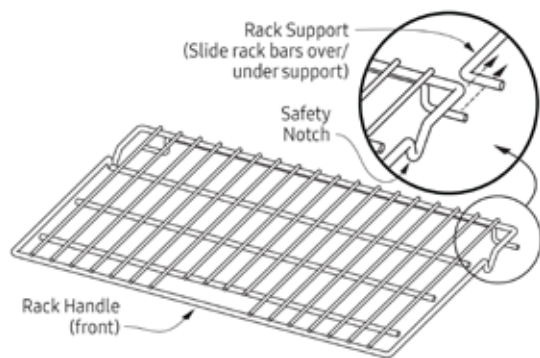

### Inserting/Removing a Standard Oven Rack

1. Grasp the rack by the front corners, and slide it onto the left-/right-side supports.
2. Start sliding the rack in, then tilt the front up so the safety notches clear the ends of the rack supports.
3. Push the rack fully in.
4. Grasp the handle area at front of the rack, and pull gently until the rack stops at the safety notches.
5. Tilt the front of the rack up so the safety notches clear the ends of the rack supports, and pull the rack fully out.

# Operating the Oven

## Positioning the Oven Racks, cont.

### Inserting/Removing a GlideRack™ Oven Rack

These racks can be pulled out farther than a standard rack and safely support filled cookware or an optional Dacor baking stone.

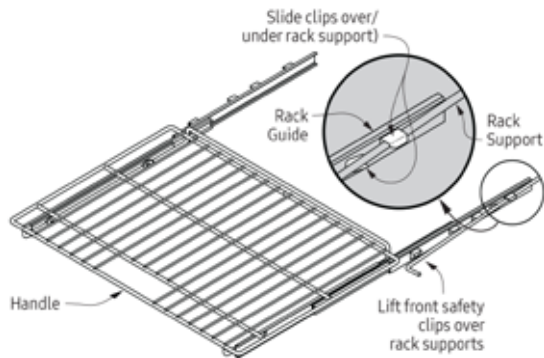

1. Align the left and right safety clips on the back of the rack guides with the rack supports.

#### **NOTE**

You can insert the rack with the guides extended or retracted.

2. Push and lift the front safety clips over the front of the rack supports.
3. Push the rack fully in.
4. Grasp the rack handle, and pull.  
The safety clips keep the rack from coming off the guides.
5. Grasp the rack at the front corners, and pull gently until the rack stops.
6. Tilt up until the front safety clips just clear the front of the rack supports, and pull the rack fully out.

#### **NOTE**

Jiggling the rack side to side as you pull eases removal.

## Running A Cook Cycle

This procedure includes selecting a cook mode, preheating the oven, inserting the food, and turning off the oven.

1. Tap a cook mode.  
The default temperature appears on the display with cook-mode icons. (See Pg. 27 for icon details).
2. (To cook at the default temp) Tap **START/CONTINUE**.  
(To change the temp) On the numeric pad, enter a temp (ex: 4-2-5), and tap **START/CONTINUE**.

#### **NOTE**

- Available temps: 100°F – 555°F (37°C – 291°C); suggested broil temp: 555°F.
  - In Pure Convection/bake/roast modes: **PRE-** (Preheating) and the current oven temp appear on the display until the oven reaches the set temp (15 – 20 min), then a chime sounds, and **PRE-** disappears.
3. When the preheat chime sounds, carefully put your food in the oven.  
Putting food in the oven during preheating will overcook the food.
  4. When finished cooking, tap **CANCEL/SECURE**.







### Changing the Cook Mode While Cooking

You can change the cook mode without interrupting the cook cycle.

- \* On the control panel, tap the new cook mode, then tap **START/CONTINUE**.

# Operating the Oven

## About the Cook Modes

Cook Mode	Description
 Convection Bake	<ul style="list-style-type: none"> <li>• Convection fan with bottom heat source; single-rack cooking in a deep pan.</li> <li>• Best for fruit crisps, custard pies, double-crust fruit pies, quiche, yeast bread, popovers.</li> <li>• Best for baking food in a deep ceramic dish or clay pot.</li> <li>• Most items require browning on top and bottom.</li> </ul>
 Convection Broil	<ul style="list-style-type: none"> <li>• Convection fan with top heat source; for food that does not need to be turned (e.g., fish, garlic bread, thinner cuts of meat).</li> <li>• See <b>Broil</b> (below) for cooking tips.</li> </ul>
 Pure Convection	<ul style="list-style-type: none"> <li>• Convection fan only; multi-rack baking.               <ul style="list-style-type: none"> <li>– Typically, for two racks, cook on Levels 3 and 5 (counting from bottom up); for three racks, use Levels 2, 4, 6.</li> <li>– You may need to lengthen single-rack cook times for multi-rack baking due to greater mass of food in oven.</li> </ul> </li> <li>• Uniform air circulation allows use of more oven space.</li> <li>• For single-/multi-rack preparation of full meals.</li> <li>• Many foods (e.g., pizza, cake, cookies, rolls, frozen dinners) can be cooked on multiple racks.</li> <li>• Good for whole roasted duck, lamb shoulder, and short leg of lamb.</li> </ul>
 Convection Roast	<p>Convection fan with top and bottom heat sources; rib roasts, whole turkeys and chickens, et al.</p>
 Bake	<p>Bottom heat source; single-rack cooking of common, basic recipes. Most recipe cook times are for Bake mode.</p> <ul style="list-style-type: none"> <li>• Follow recipe cook time and temperature; use oven timers to set cook time.</li> <li>• Avoid opening oven door to check progress.</li> <li>• Check food at shortest recommended cook time. (Cake is done if toothpick poked in center emerges clean.)</li> </ul>
 Broil	<ul style="list-style-type: none"> <li>• Top heat source; single-rack cooking of small amounts of food, smaller/thinner cuts of meat, toasting bread.</li> <li>• To reduce risk of overcooking, use rack Levels 1 – 4; results depend on rack level and type of food.</li> <li>• Some smoke is normal and needed for a broiled flavor.</li> <li>• Set the timer when broiling.</li> <li>• Use a grill over a broil pan so fat/grease drains, reducing spatter, excess smoke, and flare-ups.</li> <li>• Start with room-temp broil pan for even cooking.</li> <li>• Do not use fork or knife to turn/remove meat; doing so releases natural juices, drying the meat.</li> <li>• Broil meat just over half the specified time, then season and turn; just before removal, season again.</li> <li>• Lightly grease broiler grill to prevent sticking; to ease cleaning, remove broiler pan and grill with meat.</li> </ul>

# Operating the Oven

---

## Bake-Mode Troubleshooting

Issue	Possible Cause	Solution
Cookies burnt on bottom	Oven door opened too often	Set timer to shortest suggested cook time; check food when timer beeps; check doneness through door window
	Wrong rack level	Reposition rack
	Darkened, heat-absorbing cookie sheet used	Use bright, reflective cookie sheet
Cookies too dark on top	Rack level too high	Use lower rack level
	Dough put in oven during preheat	Put cookie dough in oven when preheating is done
Cake burnt on sides/center not done	Oven temperature too high	Reduce oven temperature
	Darkened, heat-absorbing pans used	Use bright, reflective pan
Cake cracked on top	Oven temperature too high	Reduce oven temperature
Cake not level	Range/rack not level	Level range/rack.
Pie burnt on edges/center not done	Oven temperature too high	Reduce oven temperature
	Darkened, heat-absorbing pan used	Use bright, reflective pan
	Oven/rack overcrowded	Use fewer pans

# Operating the Oven

## Cooking Tips: Cook Modes and Cookware

Subject	Tip				
Bake, Convection Bake, Pure Convection	<ul style="list-style-type: none"> <li>Do not open the oven door except to turn food; check doneness through the door window if possible.</li> <li>Time all baking tasks.</li> <li>Check doneness at the shortest suggested cook time (for cake/brownies, a toothpick/skewer poked into the center should emerge clean).</li> <li>Measure ingredients carefully and follow proven recipes.</li> </ul>				
Convection Bake	<ul style="list-style-type: none"> <li>Usually, you can reduce temp by 25°F and cook for 10% less time; baked goods have golden-brown crusts with flaky textures, and meats have crispy exteriors with natural juices sealed inside.</li> <li>Some conventional recipes, especially homemade, may need testing and adjusting when converting to convection baking; prepare a proven conventional recipe using the above convection time/temp guidelines; if results need improvement, adjust one variable (ex: cook time, rack level, temperature), and repeat the test; if needed, adjust another variable, continuing this method until results are satisfactory.</li> </ul>				
Broil	<ul style="list-style-type: none"> <li>Always set a timer.</li> <li>Lightly grease broiler grill; excess grease causes excessive smoke.</li> <li>For even cooking, start with a room-temperature broil pan.</li> <li>Use tongs or spatula to handle meats; piercing releases natural juices, resulting in drier food.</li> <li>Broil first side for just over half suggested time, then season and turn; season second side just before removal.</li> <li>To ease cleanup, remove broil pan and grill with food; discard grease, and soak cookware until ready to clean.</li> </ul>				
Roast	<ul style="list-style-type: none"> <li>Dacor's optional roasting pan offers excellent results; the "V" shaped rack lets air circulate fully around food.</li> <li>Insert temperature probe halfway into center of thickest part of meat; (poultry) insert probe between body and leg into thickest part of inner thigh; for accurate readings, probe should not touch bone/fat/gristle; check meat temp <math>\frac{2}{3}</math> into suggested roast time; after reading probe once, insert it <math>\frac{1}{2}</math>" farther into meat, and take another reading; if second reading is lower, keep cooking.</li> <li>Let roast rest 15 – 20 min's after removal to ease carving.</li> <li>Roast times vary with size/shape/quality of meat and poultry; less tender cuts are best prepared in Bake mode and may need moist-cooking techniques; follow your favorite cookbook recipes.</li> </ul>				
Bakeware	<ul style="list-style-type: none"> <li>Dacor full-sized cookie sheets take best advantage of rack space (see Pg. 4, Customer Assurance info to order).</li> <li>Use recipe's suggested pan size/type.</li> <li>Bake cakes, quick breads, muffins, and cookies in bright, reflective pans.</li> <li>Use medium-gauge-aluminum baking sheets when preparing cookies, biscuits, cream puffs, and similar items.</li> <li>Bake most frozen foods in their original foil containers on a cookie sheet. Follow package directions.</li> <li>Glass bakeware: Reduce recipe temperature by 25°F (except for pies or yeast breads).</li> <li>Follow standard recipe bake time for pies and yeast breads.</li> <li>Warped, dented, stainless-steel, and tin-coated pans give uneven results.</li> <li>Set pans gently on oven racks with long sides running left to right.</li> </ul>				
Multi-Rack Baking	<ul style="list-style-type: none"> <li>Standard Bake mode is best for multi-rack baking. Many foods (ex: pizza, cake, cookies, biscuits, muffins, rolls, and frozen prepared foods) can be cooked on two or three racks at once.</li> <li>Typically, when baking on two racks, choose from Levels 2, 4, and 6.</li> <li>When adapting a single-rack recipe to multi-rack baking, cook times may be longer due to greater volume of food.</li> </ul>				
High-Altitude Baking	The higher the altitude, the longer foods take to cook, so some recipes need adjusting. (Usually, rising baked goods need no adjustment, but letting the dough rise twice before the final pan rise develops better flavor. Try the adjustments at right. Note the changes that work best, and mark your recipes accordingly. You may also consult a cookbook on high-altitude cooking for specific recommendations.				
	Altitude (ft)	Baking Powder (ea. tsp, reduce amt. by %)	Sugar (ea. tsp, reduce amt. by %)	Liquid (for ea. cup, add %)	
	3000	5 – 10	10 – 25	5 – 10	
	5000	10	10	20	
	7000	25	20	20 – 25	



# Operating the Oven

---

## About Oven Temperatures

---

Mode	Temperature
Convection Bake	325°F (163°C)
Pure Convection	
Bake	350°F (177°C)
Convection Roast	375°F (191°C)
Broil	555°F (291°C)
Convection Broil	

You can change the factory-set cook-mode temperature without interrupting the cook cycle.

1. Tap the selected cook mode.  
The icon for that mode appears on the display.
2. On the numeric pad, enter the new temp (ex: 3-7-5), and tap **START/CONTINUE**.

### **NOTE**

- If you increase the temp by 50°F (28°C) or more, the oven enters Preheat mode to raise the temp rapidly to the new setting (**PRE-** appears on the display). You should remove the food, and return it when **PRE-** disappears.
- If you lower the temp, it is best to remove the food until the new temperature appears.

## Using Control Lockout

---

This feature disables all control-panel keys except **CANCEL/SECURE** and the oven light.

1. Tap-hold **CANCEL/SECURE** for 6 seconds.  
The control-panel keys stop working; **OFF** appears on the display.
2. Tap-hold **CANCEL/SECURE** for 3 seconds.  
All control-panel keys are enabled.

### **NOTE**

Activating control lockout turns off all active timers.

# Operating the Oven

---

## Using the Timers

---

### Enabling the 12-Hr. Oven Shut-Off Timer

The oven has a factory-programmed timer that automatically turns the oven off after 12 hours of continuous use. This timer automatically resets if you change the cook temperature or mode, and is automatically disabled when you activate Sabbath mode. You can use this same procedure to disable the 12-hr. timer.

1. With the oven off, tap-hold **TIMER 1** for 10 seconds.  
The control panel beeps, and **12Hr** appears on the display, then **ON** appears on the display.
2. Tap **#**.  
The 12-hr. timer is enabled.
3. Tap **CANCEL/SECURE**.  
The changes are saved; the clock appears on the display.

### Using the Oven's Cook Timers

You can use the oven's two timers individually/together and set them from 1 min. to 99 hrs-59 min. One indicator (**1** or **2**) appears on the display if one timer is active. Both indicators appear if both timers are active.

#### **NOTE**

- When a timer goes off, it does not turn the oven off. To automatically turn the oven off when the timer goes off, see **Using Time-Delay Cooking** (Pg. 32).
- Tapping **CANCEL/SECURE** does not reset/stop the timers.

1. On the control panel, tap **TIMER 1** or **TIMER 2**.
2. On the numeric pad, enter a cook time. (Ex: To enter 11 hrs-30 mins, tap 1-1-3-0; for 25 mins, tap 2-5).
3. Tap **START/CONTINUE**.
  - The cook time appears on the display; countdown starts.
  - When the countdown ends, the timer indicator blinks on the display, and a beep sounds. The timers have unique cadences (Timer 1: 1 sec on, 1 sec off, repeat; Timer 2: 1 sec on, 1 sec off, 2 sec's on, 1 sec off, repeat).
  - Silence the alarm by tapping the blinking timer indicator, then tap **CLOCK** to return to the main display.

### Viewing Oven Settings As the Timer Counts

While a timer is active, you can check the clock or the other timer without interrupting other settings.

- \* Tap **CLOCK** to view the time of day.
- \* Tap **TIMER 1** or **TIMER 2** to view either's time.

### Changing the Time On An Active Timer

1. Tap the timer indicator (**Timer 1** or **Timer 2**).
2. On the numeric pad, enter the new time, and tap **START**.

### Stopping an Active Timer

1. Tap the timer indicator twice.  
The timer zeroes out.
2. Tap **CLOCK** to return to the main display.

# Operating the Oven

---

## Using Time-Delay Cooking

---

### About Time-Delay Cooking

- You can set the oven to turn itself on/off.
- Time-delay is unavailable for the broil and Sabbath modes.
- You can use the timers while using time-delay cooking.
- You can cancel a time-delay cycle any time by tapping **CANCEL/SECURE**.
- When the oven is in Time-Delay mode, you can tap:
  - **CLOCK** to view the time
  - **START TIME** to view the set cook-start time
  - **STOP TIME** to view the set cook-stop time
  - **COOK TIME** to view the cook-duration time.

### **WARNING**

Food safety is critical in time-delay cooking. To avoid food-related problems:

- Do not use foods that will spoil before cooking starts (ex: eggs, dairy, cream soups, meat).
- Do not leave food in an inactive oven. Bacteria develops when the temperature drops below 140°F (60°C).
- For long-term delay starts, place only very cold or frozen food in the oven. (Most unfrozen foods should rest in the oven no more than 2 hours before cooking starts.)

### About the Time-Delay-Cooking Keys

- **START TIME**: The time of day when the oven starts cooking.
- **COOK TIME**: The amount of time the oven cooks before entering Hold mode.
- **STOP TIME**: The time of day when the oven turns off and enters Hold mode.

### **NOTE**

- If you use **COOK TIME** or **STOP TIME**, the oven enters Hold mode (**Hld** appears on the display) when it reaches the end of the set cook time. Oven temperature "holds" at 150°F (66°C) for 2 hours.
- Tap **CANCEL/SECURE** to turn the oven completely off.
- Do not leave food in the oven after Hold mode turns off.

When you set two of the time-delay-cooking keys, the oven automatically calculates the third time. There are three ways to use these keys:

- Tap **START TIME**, and set a time for the oven to turn on, then tap **COOK TIME** or **STOP TIME**, and set a time for the oven to turn off.
- Set **START TIME** only, then turn the oven off manually when cooking is done.
- Turn the oven on manually, then tap **COOK TIME** or **STOP TIME**, and set a time for the oven to turn off.

# Operating the Oven

---

## Using Time-Delay Cooking, cont.

---

### Setting a Time-Delay-Cooking Cycle

1. Place the food in the oven, and select a cook mode (except either Broil mode).
2. Enter a cook temperature.

#### **NOTE**

If you want the oven to turn on immediately and turn off automatically later, skip to Step 6.

3. Tap **START TIME**, and enter the time of day you want cooking to start (ex: 12:35, tap 1-2-3-5; you may enter a time up to 22 hr 59 min beyond the present time).
4. Tap **#**, and select **AM** or **PM**.

If you want to set a stop time or a cook time, proceed with Step 5; otherwise, skip to Step 6.

5. Tap either **COOK TIME** or **STOP TIME**.

**COOK TIME** sets the amount of time the oven will cook; **STOP TIME** sets the time of day when the oven will stop cooking. Whichever key you select, the result is the same.

#### **NOTE**

Pre-heating is unavailable for time-delay cooking. The time needed to reach the cooking temperature must be added to the cook time, which increases with the cooking temperature and amount of food.

6. Tap **START/CONTINUE**.

If you set a cook time or a stop time, the oven cooks until the set time, and enters Hold mode.

## Using the Meat-Temperature Probe

---

The doneness of bulky meat (ex: whole chicken, beef roast, ham leg) is best determined by taking the internal temperature. The oven's meat-temperature probe lets you cook food to the exact desired temperature. The probe registers temperatures from 100 – 200°F (38 – 93°C).

#### **WARNING**

- To avoid injury, use hot pads or oven mitts to handle the probe when the oven is hot.
- Always grasp the probe by its handle. (Pulling on the cable could damage the probe.)
- Only insert the skewer into fully thawed food.
- Always remove the probe from the oven after use.
- Do not use a 3rd-party probe; you risk damaging the probe and the oven.

#### **NOTE**

- The probe does not work in Broil and Sabbath modes. If you plug in the probe when in these modes, the probe icon blinks, indicating an error.
- If you unplug the probe after tapping **PROBE**, the probe icon blinks, and **OPn** appears on the display.
- If you tap **PROBE** but do not plug in the probe, the mode cancels itself after 30 seconds.
- Probe mode takes precedence over time-delay cooking. The oven keeps cooking until the meat's internal temp reaches the selected probe temp regardless of the stop time/cook time, then enters Hold mode.

# Operating the Oven

## Using the Meat-Temperature Probe, cont.

USDA SAFE INTERNAL MINIMUM TEMP'S	
Ground Meat, Meat Combinations	
Beef, pork, veal, lamb	160°F (71°C)
Turkey, chicken	165°F (74°C)
Fresh Beef, Veal, Lamb	
Steaks, roasts, chops	145°F (63°C)
Poultry	
Whole bird (temp taken in thigh)	165°F (74°C)
Breasts, roasts	
Thighs, legs, wings	
Duck, goose	
Stuffing (cooked alone or in bird)	
Ham	
Uncooked	160°F (71°C)
Reheat (whole or half)	140°F (60°C)
<b>NOTE:</b> If bacteria evolve, the temp's needed to eliminate them must evolve accordingly. For current info, call the USDA Meat and Poultry Hot Line: (800) 535-4355 or visit <a href="http://www.fsis.usdagov">www.fsis.usdagov</a> .	

1. (With the meat ready to cook) Insert the probe skewer in the thickest part of the meat away from fat and bone. With fowl, hold the skewer parallel to the pan, and insert it into the deepest part of the breast until the tip is  $\frac{3}{4}$  in. from the body cavity.
2. On the control panel, set a cook mode. The mode's preset temperature appears on the display; to change the temp, see Pg. 30.
3. Tap **START/CONTINUE**.  
**PRE-** appears on the display; the oven starts heating.
4. (When the oven chimes and **PRE-** disappears) Put on oven mitts, and put the meat in the oven.
5. Grasping its handle, plug the probe in the outlet on the oven chamber's right wall.
6. On the control panel, tap **PROBE**.
  - The preset probe temp (160°F/71°C) and the probe icon appear on the display.
  - To change the probe temp, enter the new temp via the numeric pad. (Use the chart at left as a guide.)
7. Tap **START/CONTINUE**.  
If you skip this step, Probe mode will not activate.

### CAUTION

When you use the meat-temp probe, the oven controls the cook time and shows the meat temp on the display. When the meat reaches the set temp, the oven enters Hold mode, in which the temp lowers to 150°F (66°C) for 2 hours to keep the meat warm and safe to eat. To prevent food-related illness, do not leave food in the oven beyond Hold mode. Tap **CANCEL/SECURE** to cancel Hold mode and turn the oven completely off.

### Changing Cook Modes In Probe Mode

1. Tap **CANCEL/SECURE**, then tap the desired cook mode.
2. (If you also want to change the cook temp) On the numeric pad, enter the new temp.
3. Tap **START/CONTINUE**.

### Canceling Probe Mode While Cooking

- \* Tap **PROBE** twice, and unplug the temperature probe. The oven reverts to its original settings.

# Operating the Oven

---

## Dehydrating/Defrosting Food

---

You can dehydrate or defrost food at low heat settings in Pure Convection mode.

### **WARNING**

Cook meats immediately after defrosting.

Food Type	Dehydrating Temp
Fruit	100°F (38°C)
Vegetable	125°F (52°C)
Meat	150°F (66°C)

1. Center the food on a rack, and tap **PURE CONV.**
2. (If defrosting) Enter a temperature up to 150°F (66°C).  
(If dehydrating) Place the prepared food on a drying rack; use the table at left to set the temp.
3. Tap **START/CONTINUE.**

## Using Proof Mode

---

1. Put the dough in a greased bowl, and cover with a damp cloth or with plastic wrap coated with nonstick spray.
2. On the control panel, tap **PROOF.**  
The proofing temperature cannot be changed.
3. Put the dough in the oven, and turn on the oven light.
4. Set the timer for the suggested rise time.

## Using Sabbath Mode

---

This mode complies with Jewish law for Sabbath and Holy Day use.

- Cook modes: Only Bake and Pure Convection are available.
- Other functions: The meat-temp probe and time-delay cooking are unavailable.
- Control panel: Only the oven light and **CANCEL/SECURE, START/CONTINUE, 0, 2** keys are available.
- When Sabbath mode is active, **SAb** appears on the display.
- After a power outage, the oven returns to Sabbath mode at the previous temperature setting.
- Active oven timers are automatically canceled when Sabbath mode is selected (use an oven-rack thermometer to track oven temp).
- While cooking, tap **2** > **START/CONTINUE** to raise the oven temp 25°F (15°C); tap **0** > **START/CONTINUE** to lower the temp 25°F (15°C). Per Jewish law, the bake elements are adjusted randomly when these keys are tapped, and the display is unchanged.

### Activating Sabbath Mode

Tap each successive key within 6 seconds of the previous, or the process cancels itself.

1. Tap **#**.
2. Tap **BAKE** or **PURE CONV.**
3. Tap **0** (decrease) or **2** (increase) repeatedly to change the preset oven temperature on the display.
4. Tap **START/CONTINUE.**  
Sabbath mode is active; the oven cooks in the mode you selected in Step 2.

# Operating the Oven

---

## Adjusting the Oven-Temperature Offset

---

The oven-temp offset is the factory-calibrated heat level at which a given cook mode cooks food; cook times may vary from your previous oven. If cooking results on this oven differ from those of your previous oven, you can adjust the oven-temp offset.

### **WARNING**

To ensure proper operation, do not adjust the meat-temperature probe or self-clean offset temperatures.

### **NOTE**

Do not measure oven-chamber temperature with a thermometer. Opening the door compromises the reading, and the temperature varies as heating elements cycle on and off.

1. (With the oven off) On the numeric pad, simultaneously press-hold **0** and **#**.  
Momentarily, **PASS** appears on the display.
2. Enter **6428**, and tap **START/CONTINUE**.  
**SLCt** (Select) appears on the display.
3. Select a cook mode.  
The mode's current offset temp appears on the display. (**00** appears if you have never adjusted the temp.)
4. On the numeric pad, enter the desired increase/decrease in temperature.
  - To enter a decrease, tap **#**, then the amount; to enter an increase, simply enter the amount.
  - You may enter a number from -35 to 35 for Fahrenheit and -18 to 18 for Celsius. (**Edit** appears on the display as you start entering the offset amount.)
5. Tap **START/CONTINUE**.  
The setting is saved.
6. Repeat Steps 3 – 5 for other cook-mode temps you want to offset.
7. Tap **CANCEL/SECURE**.  
The oven exits Offset mode; the main display appears.

# Maintaining the Range

---

## General Exterior Maintenance

---

### **WARNING**

- Turn off power, and let all surfaces cool before cleaning the range.
- Wear rubber gloves, and do not use abrasive cleaners/scouring pads anywhere on the range.
- Do not spray liquids anywhere on the range. (Spray the cloth or paper towel.)

### **Cleaning Stainless-Steel Surfaces**

#### **CAUTION**

To prevent scratching, wipe “with” the grain, and do not clean with abrasive cleaners/scrubbers.

1. Apply (per bottle instructions) the provided Dacor stainless-steel cleaner to a cloth or paper towel.
2. Clean one small area at a time.
3. With a soft, dry cloth, wipe the metal dry.

### **Cleaning the Oven-Door Glass**

1. Clean the door glass (inside and out) with a mild glass cleaner (per manufacturer instructions).
2. With a clean, soft cloth moistened with clean water, wipe the glass.
3. With a soft, lint-free cloth, wipe the glass dry.

### **Cleaning the Control Panel**

1. Tap-hold **CANCEL/SECURE** for 6 seconds.  
**OFF** appears on the display; the oven cannot be activated.
2. With a sponge dampened with a mild-soap and warm-water solution, clean the control panel.
3. With a soft, lint-free cloth, wipe the panel dry.
4. Press-hold **CANCEL/SECURE** for 6 seconds.  
The control panel is enabled.

## Maintaining the Cooktop

---

### **WARNING**

- (Unless otherwise specified) Before cleaning, ensure that no HOT indicators appear on any cook zones.
- To avoid dangerous fumes and cooktop damage, use only the specified cleaners as instructed. Abrasive cleaners/scrubbers may permanently damage the cooktop.
- When removing cooked-on spills, use only the provided scraper or a plastic spatula. Utilizing a knife, metal spatula, or similar tool may damage the cooktop.

### **Cleaners to Avoid**

These types of cleaners can discolor, scratch, stain, etch, or otherwise mar the cooktop glass:

- Chlorine-/ammonia-based glass cleaners
- Caustic cleaners (e.g., oven cleaners)
- Abrasive pads (e.g., metal or nylon scouring pads, Scotch Brite pads, SOS pads, certain sponges)
- Powder/liquid cleaners containing chlorine bleach or abrasives/cleaners
- Flammable liquids (e.g., paint thinner, turpentine, acetone, rubbing alcohol); some of these may not harm the glass but are not wise to use on a cooktop.



# Maintaining the Range

## Maintaining the Cooktop, cont.

### Performing Special Cleaning Tasks



#### Sugar, Syrup, Tomato Spills

Remove these **while the cooktop is hot**. Use a plastic spatula or the provided scraper, let the cooking surface cool, then with a dry towel/sponge, wipe up the residue.

#### Using the Scraper to Clean Cooktop Spills

1. Clear away all items, and via the main power button, turn OFF the cooktop.
2. Holding the scraper slightly angled **with the blade flat against the surface**, push the spill out of the cook zone. (Do not let the corner of the blade scratch the cooktop.)
3. Let the surface cool, and remove any residue.
4. Apply Dacor Cooktop Cleaning Creme. (See the section below.)

#### Burned-On Food

Lay a moist cloth towel on the soiled area for ½ hour, then wipe away the softened crust. Clean and dry the area, then apply Dacor Cooktop Cleaning Creme to the cooktop. (See the section below.)

#### Cookware Marks

1. (If the cleaning creme does not remove marks) Apply a light dusting of mild cleanser (ex: Bon Ami) to the soiled area, and gently scrub with a wet dishcloth.
2. Wipe the area with clean water, then dry the cooktop, and apply Dacor Cooktop Cleaning Creme.

#### **NOTE**

Magnetic stainless steel and porcelain-coated steel/iron pans are less likely to leave marks than other types of cookware. Uncoated cast-iron pans are more likely to mar the glass. Always lift to move cookware.

#### Water Spots

1. Apply undiluted white vinegar to the affected area, then wipe the area with clean water.
2. Dry the cooktop surface, and apply Dacor Cooktop Cleaning Creme.

#### Scratches

- Surface scratches do not compromise cooking ability.
- Avoid scratches by using clean, smooth cookware and removing gritty food spills quickly.
- Keep the cooktop clean, and regularly apply Dacor Cooktop Cleaning Creme.

### Using Dacor Cooktop Cleaning Creme

Regular application protects the cooktop surface and eases food/stain removal. Let the cooktop cool to the touch beforehand.

1. With a clean, damp cloth, apply ¼ tsp of cleaning creme to the glass.
2. With a second clean, damp cloth, remove residual cleaning creme.
3. With a clean, dry cloth, dry the cooktop.

# Maintaining the Range

---

## Using Self-Cleaning Mode

---

### About Self-Clean Mode



- Self-cleaning, which takes about 2 ½ hours, heats the oven chamber to very high temperatures to burn off surface deposits.
- Smoke from the oven chamber is normal during the first few self-clean cycles. The oven also normally makes popping sounds during self-cleaning due to metal expanding/contracting.
- Self-cleaning mode will not function if the meat-temperature probe is connected; the probe icon blinks, reminding you to remove the probe.

### **WARNING**

Exterior range surfaces will be very hot during self-cleaning.

### Self-Cleaning the Oven

#### **NOTE**

- The oven light is inactive during self-cleaning.
  - For less smoke and more efficient self-cleaning, wipe the oven chamber with a damp cloth beforehand.
1. Remove all items from the oven, including the convection filter.
  2. Wipe the surfaces around the door gasket with a vinegar-water solution, then wipe the surfaces dry. (Use a plastic scouring pad on heavily soiled surfaces.)
  3. Gently clean the door gasket (see Pg. 41).
  4. Ventilate the kitchen well.
  5. Shut the oven door, and tap **SELF CLEAN** > **START/CONTINUE**.
    - The cleaning icon () appears on the display.
    - The lock icon () appears, indicating the oven door is locked (to prevent injury from the intense heat generated during the cycle). If you do not shut the door, an error message appears; tap **CANCEL/SECURE**, wait 1 minute, and close the door. When the error clears, retry Step 5.
    - **ON** appears on the display, indicating the oven's heating elements are on.
- To stop self-cleaning: Tap **CANCEL/SECURE**. The oven door remains locked until the oven chamber has cooled significantly. (The lock symbol disappears). Range surfaces are still hot.
  - When self-cleaning is done:
    - the door latch releases when the oven chamber has cooled significantly; the cleaning icon, lock icon, and ON indicator disappear; the oven is still hot.
    - reinstall the convection filter before using the oven.
    - powdery residue normally covers the oven floor. When the oven is cool, wipe the residue with a damp cloth; rerun self-cleaning to remove residue that cannot be removed with a cloth.

# Maintaining the Range

---

## Using Self-Cleaning Mode, cont.

---

### Setting Delayed Self-Cleaning

1. Prepare the oven for self-cleaning as instructed in the previous procedure, and close the oven door.
2. Tap **SELF CLEAN > START TIME**.
3. Enter a start time (ex: for 12:30, tap 1-2-3-0; maximum delay: 22 hr, 59 min.).
4. Tap **START/CONTINUE**.
  - **DELAY** appears on the display; the oven door locks. Self-cleaning will start at the set time.
- After setting delayed self-cleaning, you can push **CLOCK** to view the time of day; with the clock displayed, you can push **START TIME** to check when self-cleaning will start. (When self-cleaning starts, **DELAY** disappears from the display, and **ON** appears.)
- To cancel delayed self-cleaning, tap **CANCEL/SECURE**.
  - If self-cleaning has not begun, the door will unlock 1 minute later.
  - If self-cleaning has begun, the door unlocks when the oven chamber has cooled to about 400°F (205°C).

## Steam-Cleaning the Oven

---

This function cleans light soil from the oven chamber. Always start with a cool oven.

### **WARNING**

- To avoid steam burns, do not pour water into a hot oven.
  - Do not touch the water in the oven chamber immediately after steam-cleaning.
1. Remove the racks and all foreign items from the oven chamber.
  2. Pour 1 ½ cups water (preferably distilled) into the recess in the oven floor.  
For slightly heavier buildup, mix the water with 1 tsp dish soap, then pour.
  3. Fold a dish towel in half lengthwise, and lay it along the oven-chamber floor so the towel's front edge overhangs the front between the door and door gasket (to catch water that may seep out), and close the door.
  4. Tap **BAKE**, and set the oven no higher than 185°F (85°C), then tap **START/CONTINUE**.
  5. Set the timer (see Pg. 31) to 20 min.
  6. When time is up, tap **CANCEL/SECURE**, and 10 minutes later, open the door.  
(Stand aside to let steam out safely; water will be on the oven walls and floor.)
  7. With a sponge, mop all water from the oven chamber. (Remove any lime with a vinegar-soaked cloth.)
  8. Dry all interior surfaces with paper towels, and leave the door ajar to let moist air escape.

# Maintaining the Range

---

## Cleaning the Oven Accessories

---

### Cleaning the Convection Filter

#### **⚠ WARNING**

After cleaning the convection filter and before using the oven, re-install the filter for proper oven function and safety from fan blades. Take care not to mar the oven porcelain when removing/reinstalling the filter.

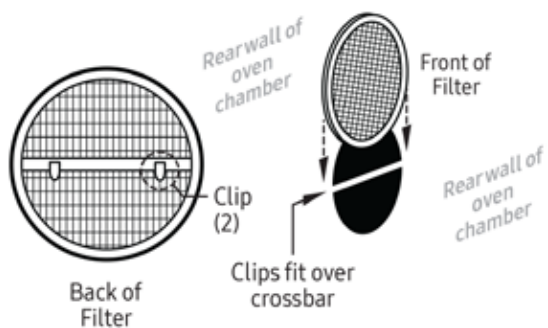

The convection filter clips to the oven's rear wall. Clean the filter regularly for efficient air circulation.

1. When the oven is cool, grasp the filter around the edges, and gently push up with your thumb(s) to release the clips.
2. Soak the filter in hot, soapy water.
3. With tap water, rinse the filter well, and let drip dry.
4. With the clips parallel with and facing the crossbar, center the filter over the fan hole, and carefully push down, hooking the clips onto the crossbar.

### Cleaning the Oven-Door Gasket

This gasket traps hot air in the oven by sealing the seam around the front of the oven chamber when the door is closed. Clean the gasket occasionally so residue does not compromise the seal around the oven door.

#### **⚠ WARNING**

Take extreme care in cleaning the fragile gasket. (Do not rub, scrub, or use harsh/abrasive cleaners and tools.)

1. Dab the door gasket with a soft cloth moistened with a mild-soap and water solution.
2. Dab the gasket with a soft cloth moistened with clean water.

### Cleaning the Oven-Rack Supports

Do not remove the supports; they will be cleaned during self-cleaning. Wipe them as you would the oven-chamber walls after self-cleaning. (See **Using Self-Cleaning Mode**, Pg. 39.)

### Cleaning the Oven Racks

#### **⚠ CAUTION**

- Do not self-clean the oven racks. Self-cleaning discolors the racks and makes them hard to slide.
- You may immerse a standard oven rack in water; do not immerse a GlideRack; doing so can foul the glide mechanism. Carefully wipe a GlideRack mechanism with a damp cloth.
- For heavy soil, use a scouring pad with soap and water, or a solution of ½ cup ammonia to 1 gallon water.

# Maintaining the Range

---

## Cleaning the Oven Accessories, cont.

---

### Cleaning the Meat-Temperature Probe

The probe has silicone handles (plug end and skewer end), a wire cable, a plug, and a stainless-steel skewer.

#### CAUTION

Do not immerse the probe in water. Doing so will likely damage the probe's electronic circuitry.

1. Clean the skewer with a plastic scouring pad and hot, soapy water.
2. Gently wipe the cable with a cloth moistened with soapy water.
3. Wipe the handles and plug with a soft sponge soaked with warm, soapy water.
4. Carefully wipe off soap with a damp cloth, keeping water away from the probe's electrical circuitry.
5. Thoroughly dry all parts of the probe with a clean, soft cloth.

### Cleaning the Oven-Light Lens

1. Softly rub the oven-light lens with the plastic-scrubber side of a sponge moistened with warm, soapy water.
2. With a clean, soft cloth moistened with clean water, rinse the lens.
3. With a soft, lint-free cloth, fully dry the lens.

## Replacing the Oven Lights

---

If no lights work, see **Troubleshooting**, Pg. 44, before replacing them.

#### WARNING

- Perform this procedure only if the oven and bulbs are cool.
- The fixture covers protect the bulbs from high temperature and mechanical shock. Do not use the oven without the covers in place.
- To avoid fixture damage when installing the cover, always align the cover's cutout with the light socket.
- Do not use a screwdriver to remove the fixture cover.
- Do not touch the replacement halogen bulb with bare fingers. Hand oil shortens the life of the bulb.

#### NOTE

Replace the light bulb only with Dacor PN 100429. (See Pg. 4 for Customer Assurance contact information.)

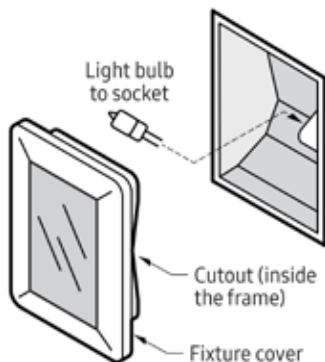

1. Turn off power to the oven at the power source.
2. Supporting the fixture cover from below, gently pry it loose with a table knife, and pull the cover straight out.
3. Pull the spent bulb straight out of the socket.
4. Wearing a glove, take the new bulb, and insert it in the socket.
5. Align the cutout on the fixture-cover frame with the light socket, and gently press the cover into place.
6. Return power to the oven, and reset the clock (Pg. 24).

# Troubleshooting

Review this section for solutions to various operational/maintenance issues, which may help you avoid a service call. If the issue persists, call Dacor Customer Assurance: 833-35-ELITE (833-353-5483).

## Cooktop

Issue	Possible Cause	Solution
Nothing works	Range not connected to power source	Have licensed electrician connect cooktop to home power supply.
	Power supply is off	Check for tripped breaker/blown fuse.
	Power failure	Call power company.
	Cooktop interior overheating	Ensure cooktop vents are clear.
Inexplicable malfunction	Spills or items on/near controls	Clean/dry the area, reset control(s); keep controls clean/clear.
	Power surge has shut off cooktop	Reset cook-zone controls.
	Empty cookware	Do not put empty cookware on cooktop or let pans boil dry.
Cook zone cycles rapidly on/off	Cookware off center	Reposition cookware.
	Cookware bottom not flat	Use flat-bottomed cookware.
	Cookware too small for cook zone	Use smaller cook zone or larger cookware.
Cookware/cooktop vibrates/buzzes	Non-magnetic cookware	Ensure cookware meets requirements (see Pg. 14).
	Cooktop/cookware is wet/greasy	Before use, ensure cooktop/cookware is clean/dry.
No Pan Detected designator flashes	<ul style="list-style-type: none"> <li>• Cook zone empty</li> <li>• Non-magnetic cookware</li> <li>• Cookware bottom not flat</li> </ul>	Use proper cookware (see Pg. 14, 15).
	Cookware off center	Center cookware on cook zone (see Pg. 15).
	Cookware too small for cook zone	Move cookware to smaller cook zone.
Food does not heat or heats too slowly	No power	See Issue > Nothing Works (this table).
	Non-magnetic cookware	Ensure cookware meets requirements (see Pg. 14).
	<ul style="list-style-type: none"> <li>• Cookware on wrong cook zone</li> <li>• Non-magnetic cookware</li> <li>• Cookware bottom not flat</li> </ul>	Use proper cookware (see Pg. 14, 15).
	Cookware off center	Center cookware on cook zone (see Pg. 15).
	Cookware too small for cook zone	Move cookware to smaller cook zone.
	Voltage weak	Have licensed electrician check voltage supply.
E2 error code appears	Cook zone element overheated	Turn off cook zone, let element cool; remove unneeded items from cooktop, clear the chassis vents; if element still does not work properly, call for service.
	Spills or items on/near controls	Clean up spills; move items away from controls.
	Reset cooktop	Turn off cooktop for 10 sec's, restore power; if error persists, call for service.

## Oven-Control Display

Issue	Possible Cause	Solution
Display is blank	Bad fuse/tripped circuit breaker.	Replace fuse/reset circuit breaker.
Controls unresponsive	Moisture/residue on panel.	Wipe away moisture/residue.
	Control lockout active.	Disable control lockout (Pg. 27).

# Troubleshooting

## Oven

Issue	Possible Cause	Solution
Oven not turning on	Oven not fully plugged in.	Verify that plug is properly inserted in outlet.
	Bad fuse/tripped circuit breaker.	Replace fuse/reset circuit breaker.
	Oven too hot.	Let oven cool.
	Incomplete service wiring.	Call for service.
	Power outage.	Check house lights; call service provider if needed.
Oven light not turning on	Light is loose/defective.	Tighten/replace light; call for service if light stays off.
	Broken light switch.	Call for service.
Excessive smoke during broiling	Meat too close to broil element.	Lower the rack one level.
	Meat not properly prepared.	Trim excess fat from meat.
	Grease buildup in oven chamber.	Clean the oven; check oven regularly for cleanliness.
Food not cooking properly	Mispositioned/unlevel rack.	See <b>Positioning the Oven Racks</b> (Pg. 25).
	Oven temp improperly set.	See <b>About Oven Temperatures</b> (Pg. 30).
Cook temp too hot/cold	Adjust oven temp.	See <b>Adjusting the Oven-Temperature Offset</b> (Pg. 36).
<ul style="list-style-type: none"> <li>Water is dripping</li> <li>Steam from door seam</li> <li>Residual water in oven</li> </ul>	Type of food being cooked.	Not a malfunction; let oven cool, then wipe with dry towel.
Oven will not self-clean	Oven is too hot.	Let oven cool, then reset controls (Pgs. 30, 36).
	Oven controls incorrectly set.	See <b>Using Self-Cleaning Mode</b> (Pg. 39).
	Control lockout is enabled.	Disable control lockout (Pg. 30).
Excessive smoke when self-cleaning	Excessive residue in oven.	Press OFF; ventilate kitchen; wait for self-cleaning to cancel; wipe up excess soil, restart self-cleaning.
Oven door stays locked after self-cleaning	Oven is too hot.	Door will open when oven cools sufficiently.
Oven still dirty after self-cleaning	Oven controls incorrectly set.	See <b>Using Self-Cleaning Mode</b> (Pg. 39).
	Oven too heavily soiled.	Wipe up food residue, then start self-cleaning; very dirty ovens may need two cycles or longer cycles.
Steam from oven vent	Normal for convection modes.	Normal operation.
	Large amount of food in oven.	
Burning or oily odor emits from oven vent	New oven.	To eliminate the smell faster, set self-cleaning to 3+ hrs; see <b>Using Self-Cleaning Mode</b> (Pg. 39).
Strong odor	Insulation in new oven.	Run oven empty on Bake at 400°F for 1 hr.
Fan noise	Convection fan cycling on/off.	Normal operation.
Oven racks hard to slide	Chrome racks were left in oven during self-cleaning.	Dab some vegetable oil on a paper towel, and wipe oven-rack edges.
Oven door is locked	Tripped circuit breaker or power outage while door was locked.	Enable then disable Control Lockout; see <b>Using Control Lockout</b> (Pg. 30).

# Warranty

---

## What Is Covered

---

**CERTIFICATE OF WARRANTIES: DACOR RANGES WITHIN THE 50 STATES OF THE USA, THE DISTRICT OF COLUMBIA, AND CANADA:**

### Full 1-Year Warranty

The warranty applies only to Dacor Heritage appliances sold to the original purchaser, starting from the original retail purchase date or closing date for new construction, whichever period is longer. The warranty is valid on Modernist products purchased new from a Dacor Authorized Dealer or other Dacor-authorized seller.

If, within 1 year of the original purchase date, your Dacor Heritage product malfunctions due to material or manufacturing defect, Dacor will restore the appliance to its proper function at no charge to you.

All cosmetic damage (e.g., scratches on stainless steel, paint/porcelain blemishes) to the appliance or included accessories must be reported to Dacor within 60 days of the original purchase date to qualify for warranty coverage.

### Limitations of Coverage

Service will be provided by a Dacor-designated service company during regular business hours.

These providers are independent entities and not Dacor agents. Dealer display and model-homedisplay products with a production date greater than 5 years, products sold "As Is," and products installed for non-residential use (religious organizations, fire stations, bed & breakfast, spas, etc.) carry a 1-year parts warranty only. All delivery, installation, labor costs, and other service fees are the purchaser's responsibility.

The warranty is null and void:

- on any product whose serial numbers and tags have been altered/defaced/removed.
- if a non-ETL-/non-CUL-approved product is transported from the USA.

The owner must provide proof of purchase or closing statement for new construction upon request.

All Dacor products must be accessible for service.

**OUTSIDE THE 50 STATES OF THE USA, THE DISTRICT OF COLUMBIA, AND CANADA:**

### Limited First-Year Warranty

If your Dacor product malfunctions within 1 year of the original purchase date due to a defect in material or workmanship, Dacor will furnish a new part, FOB factory to replace the defective part.

Delivery, installation, labor costs, and other service fees are the purchaser's responsibility.



# Warranty

---

## What Is Not Covered

---

- Slight color variations due to differences in painted parts, ambient lighting, product location, other factors.
- Service calls to educate the owner on product use and care.
- Service fees for travel to islands and remote areas (including but not limited to ferries, toll roads, and other travel expenses).
- Consequential or incidental damage (including but not limited to food or medicine loss, lost work time, or restaurant meals).
- Product failure under non-residential use (e.g., commercial, industrial, b&b, religious organization).
- Product failure due to improper installation.
- Consumable parts (e.g., filters, light bulbs).
- Replacement of house fuses, fuse boxes, or resetting of circuit breakers.
- Damage due to so-called "acts of God" (e.g., fire, flood, power outage/surge).
- Liability for damage to surrounding property (e.g., cabinetry, floors, ceilings, countertops).
- Breakage/discoloration/damage to glass, metal surfaces, plastic parts, trim, paint, or other cosmetic finish due to abuse, neglect, improper use/care.

## Out-of-Warranty Products

---

Should you experience a service issue after the standard warranty period expires, contact Dacor Customer Assurance nonetheless. Dacor reviews each issue and customer concern to provide the best possible solution for the customer under the individual circumstances.

THE REMEDIES IN THE ABOVE EXPRESS WARRANTIES ARE THE SOLE AND EXCLUSIVE REMEDIES; THUS, NO OTHER EXPRESS WARRANTIES ARE MADE, AND OUTSIDE THE 50 STATES OF THE UNITED STATES, THE DISTRICT OF COLUMBIA AND CANADA, ALL IMPLIED WARRANTIES, INCLUDING BUT NOT LIMITED TO, ANY IMPLIED WARRANTY OF MERCHANTABILITY OR FITNESS FOR A PARTICULAR USE OR PURPOSE, ARE LIMITED IN DURATION TO 1 YEAR FROM THE ORIGINAL PURCHASE DATE. DACOR SHALL NOT BE LIABLE FOR INCIDENTAL EXPENSE OR CONSEQUENTIAL DAMAGES. SHOULD DACOR PREVAIL IN ANY LAWSUIT, DACOR SHALL BE ENTITLED TO REIMBURSEMENT OF ALL COSTS AND EXPENSES, INCLUDING ATTORNEY'S FEES, FROM THE DACOR CUSTOMER. NO WARRANTIES, EXPRESS OR IMPLIED, ARE MADE TO ANY BUYER FOR RESALE.

Some states do not allow limitations on how long an implied warranty lasts, or do not allow the exclusion or limitation of inconsequential damages; therefore, the above limitations or exclusions may not apply to you. This warranty gives you specific legal rights, and you may also have other rights that vary from state to state.

# Notes

---

fold here



NO POSTAGE  
NECESSARY  
IF MAILED  
IN THE  
UNITED STATES

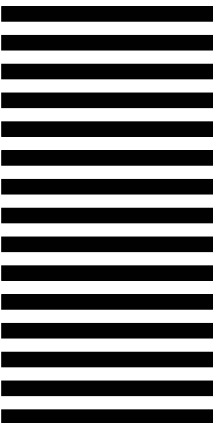

**BUSINESS REPLY MAIL**  
FIRST-CLASS MAIL PERMIT NO 1600 CITY OF INDUSTRY CA

POSTAGE WILL BE PAID BY ADDRESSEE

**DACOR  
ATTN WARRANTY PROCESSING DEPT  
PO BOX 90070  
CITY OF INDUSTRY CA 91715-9907**





Please visit [www.dacor.com](http://www.dacor.com) to activate your warranty online.

# WARRANTY INFORMATION

**IMPORTANT:**

Your warranty will not be activated until you activate it online or return this form to Dacor. If you have purchased more than one Dacor product, please return all forms in one envelope, or activate the warranty online for each product.

Please be assured that Dacor will never sell your name or any information on this form for mailing-list purposes, as we do not consider it a proper way of expressing our gratitude for your having chosen Dacor products for your kitchen!

Owner Last Name (please print) \_\_\_\_\_ First \_\_\_\_\_ Middle Init. \_\_\_\_\_

Street \_\_\_\_\_

City \_\_\_\_\_ State \_\_\_\_\_ Zip \_\_\_\_\_

Purchase Date \_\_\_\_\_ Email \_\_\_\_\_ Phone \_\_\_\_\_

Dealer \_\_\_\_\_

City \_\_\_\_\_ State \_\_\_\_\_ Zip \_\_\_\_\_

Your willingness to take a few seconds to complete the section below will be sincerely appreciated. Thank you.

1. How were you first exposed to Dacor products? (Please check one.)

- A. T.V. Cooking Show
- B. Magazine
- C. Appliance Dealer Showroom
- D. Kitchen Dealer Showroom
- E. Home Show
- F. Builder
- G. Architect/Designer
- H. Another Dacor Owner
- I. Model Home
- J. Other \_\_\_\_\_

2. Where did you buy your Dacor appliances?

- A. Appliance Dealer
- B. Kitchen Dealer
- C. Builder Supplier
- D. Builder
- E. Other \_\_\_\_\_

3. For what purpose was the product purchased?

- A. Replacement only
- B. Part of a Remodel
- C. New Home
- D. Other \_\_\_\_\_

4. What is your household income?

- A. Under \$75,000
- B. \$75,000 – \$100,000
- C. \$100,000 – \$150,000
- D. \$150,000 – \$200,000
- E. \$200,000 – \$250,000
- F. Over \$250,000

5. What other brands of appliances do you have in your kitchen?

- A. Cooktop \_\_\_\_\_ C. Dishwasher \_\_\_\_\_
- B. Oven \_\_\_\_\_ D. Refrigerator \_\_\_\_\_

6. Would you buy or recommend another Dacor product?

- Yes
- No

Comments \_\_\_\_\_

\_\_\_\_\_  
\_\_\_\_\_

Thank you very much for your assistance. The information you have provided will be extremely valuable in helping us plan for the future and in giving you the support you deserve.



cut here

cut here