



# UNDER COUNTER REFRIGERATION DRAWERS

## DETAILED PLANNING DIMENSIONS GUIDE

JUCFP242HL, JUCFP242HM, JUCFP242HX, JUDFP242HL, JUDFP242HM, JUDFP242HX  
 23<sup>7</sup>/<sub>8</sub>" (W) x 34<sup>3</sup>/<sub>8</sub>" (H) x 23<sup>1</sup>/<sub>4</sub>" (Depth without door panels/handles)

Choose one of following configuration to match your kitchen design.

Double Drawer Refrigerator/Freezer			Double-Refrigerator Drawers		
Base Unit (Panel Ready)	RISE™ Model	NOIR™ Model	Base Unit (Panel Ready)	RISE™ Model	NOIR™ Model
JUCFP242HX	JUCFP242HL	JUCFP242HM	JUDFP242HX	JUDFP242HL	JUDFP242HM

### OPTIONAL ACCESSORIES FOR CUSTOM OVERLAY DESIGNS

#### RISE™ STAINLESS HANDLE KIT

- W11231237
- For use with Custom Overlay panels
- Quantity - One handle per kit (2 kits are required for one product)

#### NOIR™ STAINLESS HANDLE KIT

- W11231236
- For use with Custom Overlay panels
- Quantity - One handle per kit (2 kits are required for one product)

Because Whirlpool Corporation policy includes a continuous commitment to improve our products, we reserve the right to change materials and specifications without notice.

Dimensions are for planning purposes only. For complete details, see Installation Instructions packed with product. Specifications subject to change without notice.



# UNDER COUNTER REFRIGERATION DRAWERS

## DETAILED PLANNING DIMENSIONS GUIDE

JUCFP242HL, JUCFP242HM, JUCFP242HX, JUDFP242HL, JUDFP242HM, JUDFP242HX  
 23<sup>7</sup>/<sub>8</sub>" (W) x 34<sup>1</sup>/<sub>8</sub>" (H) x 23<sup>3</sup>/<sub>16</sub>" (Depth without door panels/handles)

### PRODUCT DIMENSIONS

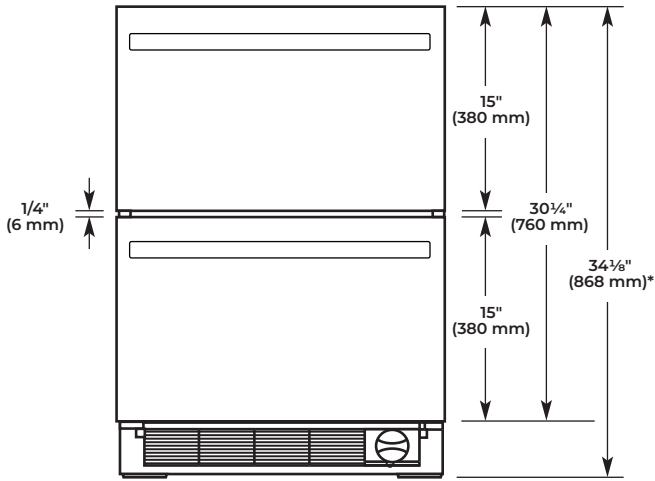

RISE™/NOIR™/Panel Ready (FRONT VIEW)

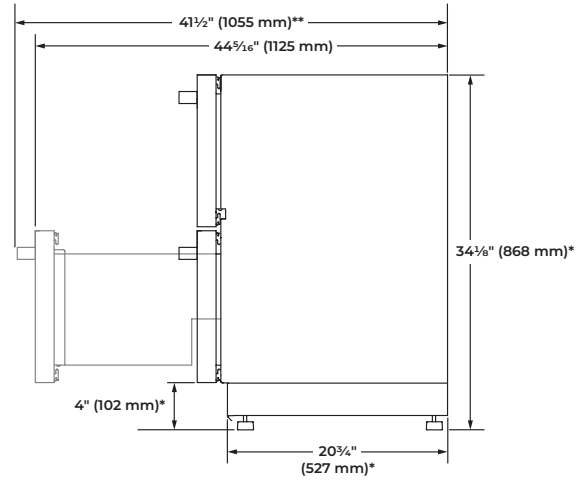

RISE™/NOIR™/Panel Ready (SIDE VIEW)

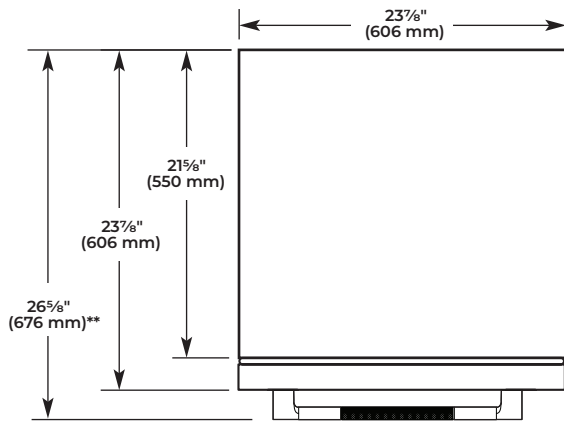

RISE™/NOIR™ (TOP VIEW)

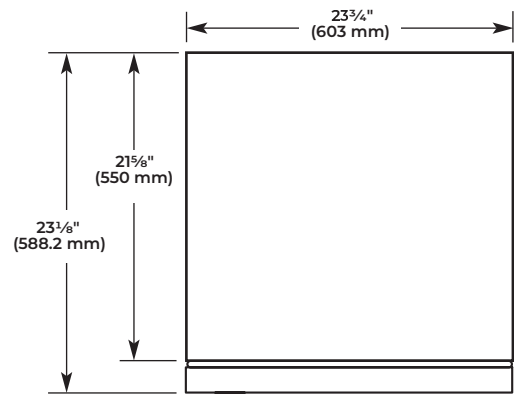

Panel Ready (TOP VIEW)

\*Add 3/4" (1.9 cm) to the height dimension when leveling legs are fully extended.

\*\*For custom panel models, this will vary.

Because Whirlpool Corporation policy includes a continuous commitment to improve our products, we reserve the right to change materials and specifications without notice.

Dimensions are for planning purposes only. For complete details, see Installation Instructions packed with product. Specifications subject to change without notice.



# UNDER COUNTER REFRIGERATION DRAWERS

## DETAILED PLANNING DIMENSIONS GUIDE

JUCFP242HL, JUCFP242HM, JUCFP242HX, JUDFP242HL, JUDFP242HM, JUDFP242HX  
 23<sup>7</sup>/<sub>8</sub>" (W) x 34<sup>3</sup>/<sub>8</sub>" (H) x 23<sup>1</sup>/<sub>16</sub>" (Depth without door panels/handles)

### OPENING DIMENSIONS

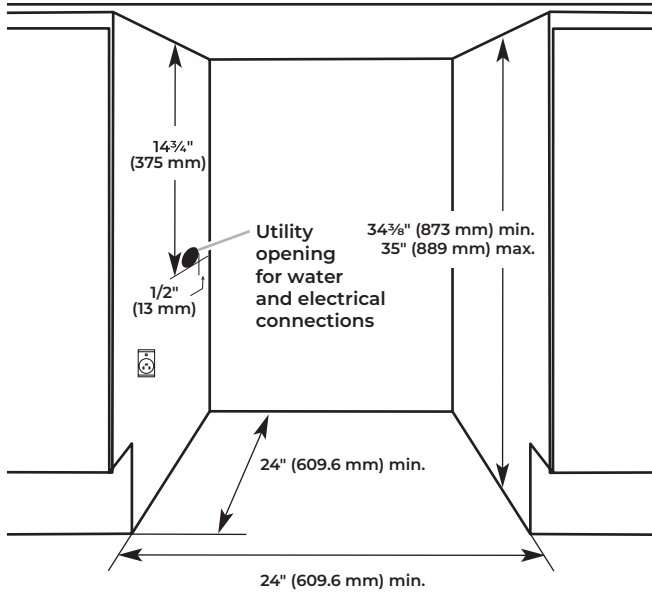

### ELECTRICAL REQUIREMENTS

## ⚠ WARNING



### Electrical Shock Hazard

**Plug into a grounded 3 prong outlet.**

**Do not remove ground prong.**

**Do not use an adapter.**

**Do not use an extension cord.**

**Failure to follow these instructions can result in death, fire, or electrical shock.**

A 115 V, 60 Hz, AC only, 15 A or 20 A fused, grounded electrical supply is required. It is recommended that a separate circuit serving only your refrigerator be provided. Use an outlet that cannot be turned off by a switch. Do not use an extension cord.



# UNDER COUNTER REFRIGERATION DRAWERS

## DETAILED PLANNING DIMENSIONS GUIDE

JUCFP242HL, JUCFP242HM, JUCFP242HX, JUDFP242HL, JUDFP242HM, JUDFP242HX  
23<sup>7</sup>/<sub>8</sub>" (W) x 34<sup>7</sup>/<sub>8</sub>" (H) x 23<sup>3</sup>/<sub>16</sub>" (Depth without door panels/handles)

### LOCATION REQUIREMENTS

**⚠ WARNING**



**Explosion Hazard**

**Keep flammable materials and vapors, such as gasoline, away from refrigerator.**

**Failure to do so can result in death, explosion, or fire.**

For the refrigerator to be flush with the front of the base cabinets, remove any baseboards or moldings from the rear of the opening.

Flooring under product must be at the same level as the room. If the floor of the opening is not level with the kitchen floor, shim the opening to make it level with the kitchen floor.

### WATER SUPPLY REQUIREMENTS

A cold water supply with water pressure of between 30 psi and 120 psi (207 kPa and 827 kPa) is required to operate ice maker. If you have questions about your water pressure, call a licensed, qualified plumber.

#### REVERSE OSMOSIS WATER SUPPLY

**IMPORTANT:** The pressure of the water supply coming out of a reverse osmosis system going to the water inlet valve of the refrigerator needs to be between 30 psi and 120 psi (207 kPa and 827 kPa).

If a reverse osmosis water filtration system is connected to your cold water supply, the water pressure to the reverse osmosis system needs to be a minimum of 40 psi to 60 psi (276 kPa to 414 kPa).

If the water pressure to the reverse osmosis system is less than 40 psi to 60 psi (276 kPa to 414 kPa):

- Check to see whether the sediment filter in the reverse osmosis system is blocked. Replace the filter if necessary.
- Allow the storage tank on the reverse osmosis system to refill after heavy usage.

If you have questions about your water pressure, call a licensed, qualified plumber.



# UNDER COUNTER REFRIGERATION DRAWERS

## DETAILED PLANNING DIMENSIONS GUIDE

JUCFP242HL, JUCFP242HM, JUCFP242HX, JUDFP242HL, JUDFP242HM, JUDFP242HX  
 23<sup>3</sup>/<sub>4</sub>" (W) x 34<sup>3</sup>/<sub>8</sub>" (H) x 23<sup>1</sup>/<sub>16</sub>" (Depth without door panels/handles)

### WOOD PANEL GUIDE

#### ⚠ CAUTION

##### Pinch Hazard

Installation of door panels with less than a <sup>3</sup>/<sub>8</sub>" (0.95 cm) gap between the door panel and the adjacent cabinet increases the risk of potential pinching.

#### IMPORTANT:

- Panel dimensions shown are the minimum size to cover the appliance door. Panels can be made taller/wider to match surrounding cabinetry.
- The recommended thickness of the overlay panel is <sup>3</sup>/<sub>4</sub>" (19 mm).
- Custom glass door overlay panel must not weigh more than 10 lbs (4.54 kg).
- Overlay panels weighing more than recommended may cause damage to your appliance.

#### TOP AND BOTTOM OVERLAY DRAWER PANEL DIMENSIONS

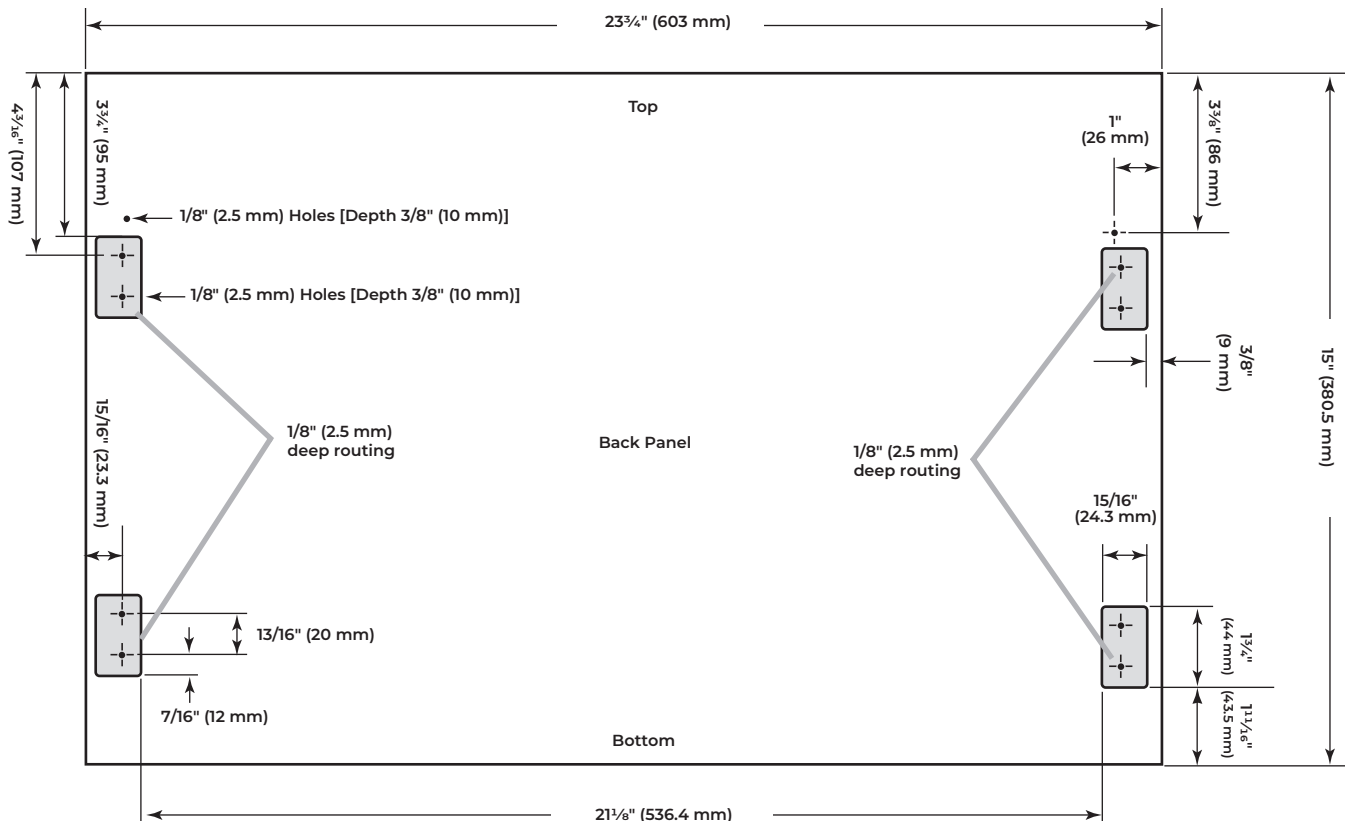

Because Whirlpool Corporation policy includes a continuous commitment to improve our products, we reserve the right to change materials and specifications without notice.

Dimensions are for planning purposes only. For complete details, see Installation Instructions packed with product. Specifications subject to change without notice.