

DISHDRAWER™ DISHWASHER

NZ AU US CA GB IE

Keep this document handy for easy reference.

- For detailed information on the features of your dishwasher, see your 'User guide'.
- Before using your dishwasher, make sure you read the full 'User guide', with special attention to the 'Safety and warnings' section.
- For contact information or if you require service, assistance or replacement parts, see the end of this document or your 'Service & warranty' booklet.

YOUR MODEL

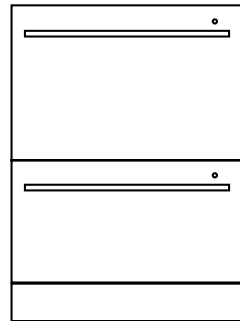

Double models
DD60DDFX9
DD60DDFHX9
DD24DDFTX9

Note: each drawer can run independently of the other drawer.

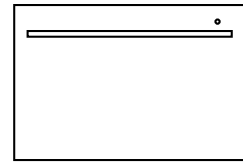

Single models
DD60SDFX9
DD60SDFTX9
DD60SDFHX9
DD24SDFTX9

OPERATING INSTRUCTIONS - STARTING A WASH

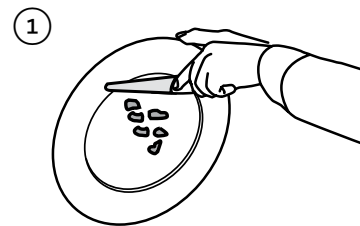

Discard scraps

Scrape large food particles off (e.g. bones, fruit stones) and remove any foreign objects (e.g. toothpicks, strings, paper).

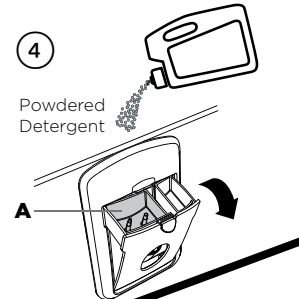

Add detergent

Fill the detergent dispenser (A) with powdered detergent and close the dispenser door.

IMPORTANT!
Do not place liquid detergent or tablets in the detergent dispenser.

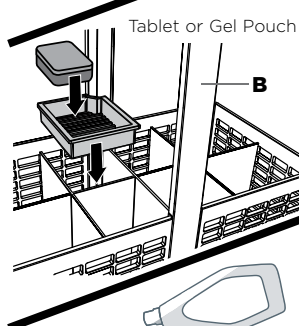

If using a tablet or gel pouch, place it in the cutlery basket (B) or at the edge of the base rack (see user guide for details).

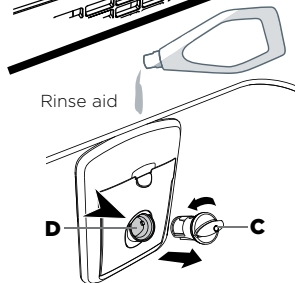

Check rinse aid

If the indicator on its plug (C) glows bright red, refill the rinse aid dispenser (D) with liquid rinse aid. Make sure you then refit the rinse aid plug back into its original position, by rotating the plug back into an upright position.

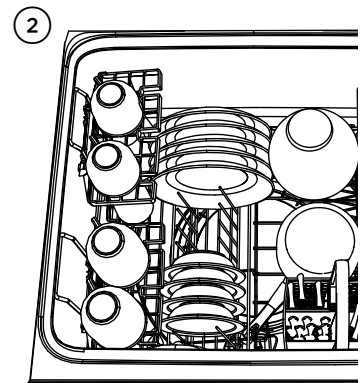

Load dishes carefully

To help with wash performance, arrange dishes so they are evenly spaced and not nesting.

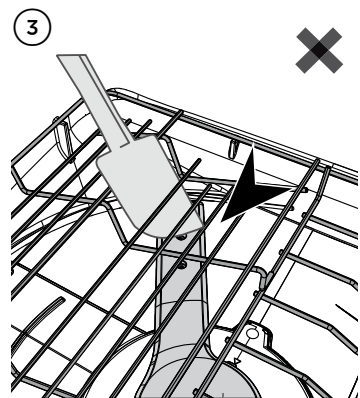

Check spray arm(s) are mounted correctly and can rotate fully around

Check the spray arm is mounted correctly by physically rotating it around with your hand.

Before a wash, ensure there are no items blocking the spray arm(s) from rotating.

Rotating Spray arm

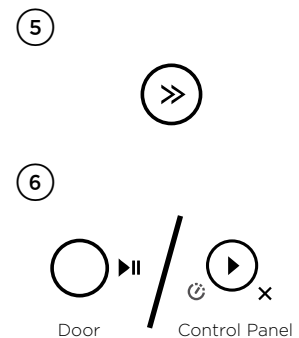

Select wash

Press >> to select a wash program.

Start wash or set Delay start

To start wash:
Close the drawer and press ► OR Press ► on the control panel before closing the door

To set delay start:
Press and hold ► to set the delay start time, then close the drawer.
Note: Each tone indicates a 1h delay.

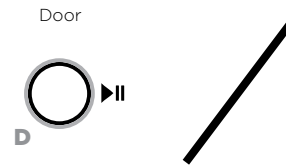

Control Panel



Indicators Description

Off/On

Opening the drawer will automatically turn the dishwasher on. If the dishwasher is in an idle state, touch any button to reactivate it.

1 Wash program indicators

If lit: The wash program has been selected.

2 Lock indicator

If lit: Keylock or childlock is activated.

3 Wash modifier indicators

If lit: The wash modifier has been selected. The wash program length and temperature will be modified accordingly.

4 Delay start indicator

If lit: Delay start is set. The wash program will start after the selected time delay (1-12h)

Controls Description

A WASH PROGRAM SELECTOR

Press >> to scroll through the wash program options.

See opposite table for program descriptions.

WASH PROGRAM	DESCRIPTION
Heavy	Heavily soiled pots, pans and dishes.
Medium	Dishes that are quite heavily soiled or food soils that have been left to dry overnight.
Eco (default setting)	Normally soiled dishes for optimum water and energy usage. The US/Canada Energy Guide is based on this program.
Fast	Lightly soiled dishes.
Delicate	Lightly soiled and heat sensitive crockery.
Rinse	Prevents odours and soils from drying on dishes.

B WASH MODIFIER SELECTOR

Press ★ to scroll through the wash modifier options.
Note: Not all modifiers are available for all wash programs.

Keylock

Disables all the buttons (helpful when cleaning the dishwasher).

To activate:

Press and hold ★ until you hear a tone. The lock indicator will light up.

Childlock

Disables all the buttons and locks the drawer closed (preventing unauthorised use by children).

To activate:

Press and hold ★ until you hear two tones. The lock indicator will light up.

To cancel keylock/childlock:

If the drawer is open
Press and hold ★ until you hear a tone. The lock indicator will go out.
If the drawer is closed
Press and hold ► until you hear a tone. The lock indicator will go out.

C/D START SELECTOR (either on door or inner control panel)

To start wash:
Close the drawer and press ► OR Press ► on the control panel before closing the door

To Pause:

Press ►
• Wait for three short and one long tone before opening the drawer. **Forcing it open mid cycle may cause damage or injury.**
• If the drawer is not restarted within seven minutes it will sound intermittently until it is restarted.

Delay start

Press and hold ► to set the delay start time. Each tone indicates a 1h delay (up to 12h). The delay start indicator will light up.
• If you scroll past 12h the dishwasher will exit delay start. To re-enter delay start follow step 1 above.
• The wash will start when the delay time is over, provided the drawer is closed.

DD24 models only US/CA

If drawer is not closed within 4 seconds of setting delay start, OR If the drawer is opened after delay start has been set (for example, to load more dishes), delay start will be suspended.

To resume:

Press ► and close the drawer OR close the drawer and press ► .

Cancel wash/delay start ✕

Press and hold ► OR ► .
• If there is any water in the drawer, it will automatically drain before the dishwasher turns off.

DURING AND AFTER THE WASH

During the wash the button on the dishwasher door will be illuminated.
At the end of the wash the dishwasher will beep six times and the button will stop being illuminated.



You may notice the following noises at the end of the wash. These are all part of normal operation:

- Both drawers may be draining simultaneously.
- The drying fan may continue to run after a wash program has finished for a set time or until the drawer is opened. The fan assists with drying and uses negligible amounts of energy.

For best drying results, we recommend unloading the dishes within a few hours after a wash program has finished.

DOS AND DON'TS OF LOADING

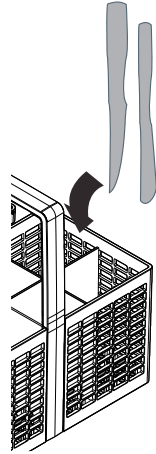

Sharp or pointed items must be placed horizontally or with sharp edges/points facing down to avoid risk of injury.

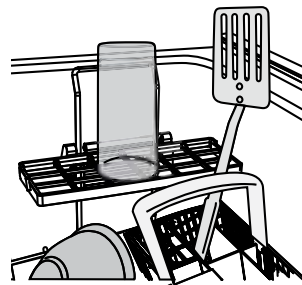

Protruding items will stop the internal lid of the dishwasher from sealing properly, which could result in a service call.

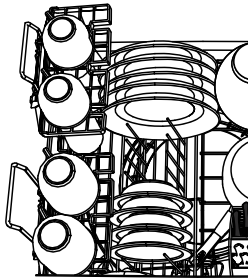

A neatly arranged load with evenly spaced dishes helps wash performance.

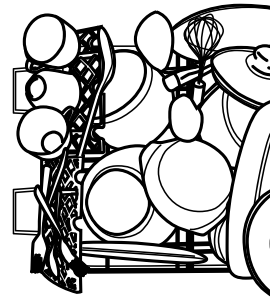

Overcrowding reduces wash performance.

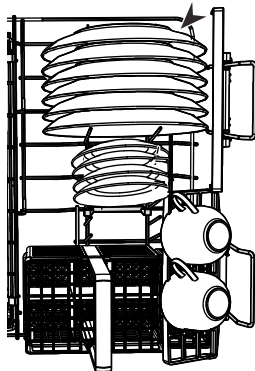

Ensure there is enough space between plates. Mix spoons, knives and forks within the cutlery basket to prevent them from nesting.

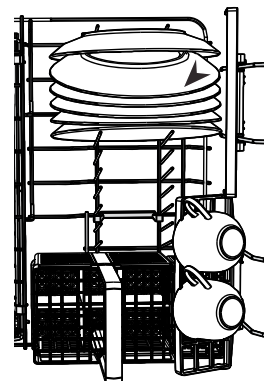

If plates and cutlery are nesting, they are less likely to be cleaned well.

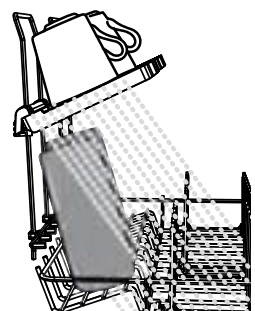

Ensure that water reaches all items on the racks.

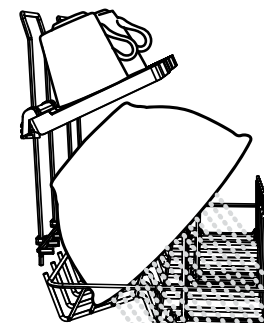

Dishware is blocking water from reaching items on the racks.

PREFERENCE OPTIONS

You can change the setting of these options to suit your preferences or circumstances. We recommend selecting the most suitable settings before you start using your dishwasher.

OPTION	RINSE AID	WATER SOFTENER (SOME MODELS ONLY)	OPEN DRAWER AUTO POWER-ON (SUITABLE AS A SABBATH OPTION)	TURN TONES OFF	CLOSED DRAWER AUTOLOCK
What does it do?	Regulates the amount of rinse aid dispensed. Reduce this setting if there is excess foam after a wash. Increase this setting if dishes are wet or streaky after a wash.	Refer to the 'Water softener' section of the 'User guide' for details.	Your dishwasher is factory-set to automatically power on for 30 seconds whenever you open the drawer. You can turn this setting off.	This turns all tones off except for fault alerts.	When this setting is on, the drawer will automatically lock 30 seconds after it's closed. It can then be unlocked by pressing and holding ► on the dishwasher door. Useful in boats or motor homes.

How to change the setting of an option

- CHECK**
Check that there is no wash underway, then open the drawer.
- ENTER MENU**
To enter the menu: Press and hold the ► and ★ together for four seconds.
 - You are now in the Rinse aid option of the preference options menu.
 - To change the Rinse aid setting, go to step 4 now.
- SCROLL TO OPTION**
Press ★ to scroll to the next option. The wash modifier indicators will display which option is selected (see table below). When you have scrolled to the end of the sequence, the menu will start again with Rinse aid.
- CHANGE SETTING**
Press ► to change the setting within an option. The wash program indicators will display which setting is selected (see table below).
- SAVE SETTING & QUIT MENU**
Press ► to save the new setting and quit the preference options menu.

Double models only:

You can use either drawer to change the settings. Changing the settings in one tub will set your preferences for the whole dishwasher.

OPTION	RINSE AID	WATER SOFTENER (SOME MODELS ONLY)	OPEN DRAWER AUTO POWER-ON (SUITABLE AS A SABBATH OPTION)	TONES AT END OF WASH	CLOSED DRAWER AUTOLOCK
Which option am I in?	<ul style="list-style-type: none"> ◄ Extra Dry ◄ Quick ◄ Sanitize 	<ul style="list-style-type: none"> ◄ Extra Dry ◄ Quick ◄ Sanitize 	<ul style="list-style-type: none"> ◄ Extra Dry ◄ Quick ◄ Sanitize 	<ul style="list-style-type: none"> ◄ Extra Dry ◄ Quick ◄ Sanitize 	<ul style="list-style-type: none"> ◄ Extra Dry ◄ Quick ◄ Sanitize
Possible settings	0 to 5 (max)	0 to 5 (max)	On or Off	On or Off	On or Off
Example	4 indicators lit = setting 4			On	
	<ul style="list-style-type: none"> ◄ Heavy ◄ Medlum ◄ Eco ◄ Fast ◄ Delicate ◄ Rinse 			<ul style="list-style-type: none"> ◄ Heavy ◄ Medlum ◄ Eco ◄ Fast ◄ Delicate ◄ Rinse 	
	1 indicator lit = setting 1			Off	
	<ul style="list-style-type: none"> ◄ Heavy ◄ Medlum ◄ Eco ◄ Fast ◄ Delicate ◄ Rinse 			<ul style="list-style-type: none"> ◄ Heavy ◄ Medlum ◄ Eco ◄ Fast ◄ Delicate ◄ Rinse 	

FOR MORE INFORMATION

For detailed information on the features of your dishwasher



see your 'User guide'

For warranty information



see your 'Service and warranty' booklet

If you...

- have any questions or comments
- need a Fisher & Paykel authorized technician to service your product
- need replacement parts or accessories
- want to register your product



see your 'Service and warranty' booklet or contact us via our website: www.fisherpaykel.com