

FISHER & PAYKEL

ACTIVESMART™ REFRIGERATOR

**ICE & WATER, AUTOMATIC ICE
AND NON-ICE & WATER MODELS**

**RF135B, RF170B, RF170W,
RF170A & RF201A models**

INSTALLATION GUIDE / USER GUIDE

US CA

CONTENTS

Introduction	3
Safety and warnings	4
Installation instructions	9
Moving or storing your appliance	23
ActiveSmart™ operating instructions	24
Temperature control (all models)	24
All about the external display (Ice & Water models only)	28
Using your water dispenser (Ice & Water models only)	29
Water filter (Ice & Water and Automatic Ice models only)	30
Using your ice maker (Ice & Water and Automatic Ice models only)	31
ActiveSmart™ special features	32
Cleaning and caring for your refrigerator	35
Storing food in your refrigerator	39
Storing food in your freezer	41
ActiveSmart™ user warnings and sounds	43
Troubleshooting	44
Service and warranty	49

IMPORTANT!

SAVE THESE INSTRUCTIONS

The models shown in this user guide may not be available in all markets and are subject to change at any time. For current details about model and specification availability in your country, go to our website fisherpaykel.com or contact your local Fisher & Paykel dealer.

Note: the word 'refrigerator', throughout this user guide, refers to the combination of refrigerator/freezer products.

Registration

Register your product with us so we can provide you with the best service possible.

To register your product visit our website: fisherpaykel.com

INTRODUCTION

Thank you for buying a Fisher & Paykel ActiveSmart™ refrigerator.

At Fisher & Paykel we are very proud of this refrigerator. This refrigerator combines size and storage space with the latest features and functions.

Thousands of hours of food care research and refrigeration experience has been programmed into your refrigerator to give you the best possible performance.

We hope you enjoy your new refrigerator.

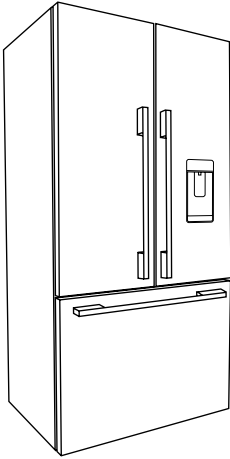

Refrigerator French door and freezer drawer

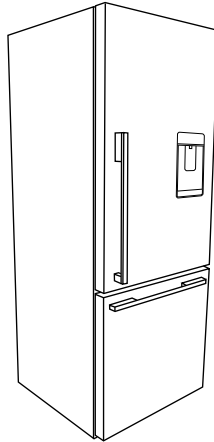

Refrigerator door and freezer drawer

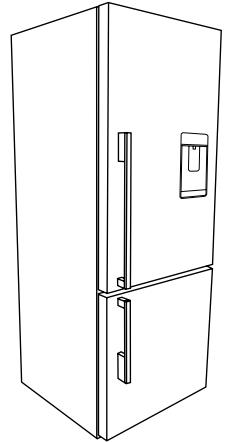

Refrigerator door and freezer door

Note: Automatic Ice and non-Ice & Water models do not have an external water dispenser.

ActiveSmart™ refrigerators have two handle options, shown below.

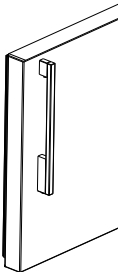

Designer handles

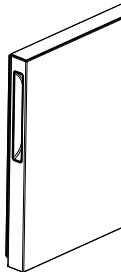

Recessed handles

WARNING!



Electric Shock Hazard

Read and follow the safety and warnings outlined in this user guide before operating this appliance.

Failure to do so can result in death, electric shock, fire or injury to persons.

Use this appliance only for the intended purpose as described in the user guide.

IMPORTANT SAFETY INSTRUCTIONS

WARNING!

When using this appliance always exercise basic safety precautions including the following:

- This appliance is not intended for use by persons (including children) with reduced physical, sensory or mental capabilities, or lack of experience and knowledge, unless they have been given supervision or instruction concerning use of the appliance by a person responsible for their safety.
- Children should be supervised to ensure they do not play with the appliance.
- The manufacturer's installation instructions for product and cabinetry ventilation must be followed when installing the appliance.
- To avoid hazard due to instability of the appliance, it must be fixed in accordance with installation instructions.
- Keep ventilation openings, in the appliance enclosure or in the built-in structure, clear of obstruction.
- Do not use mechanical devices or other means to accelerate the defrosting process, other than those recommended by the manufacturer.
- Do not damage the refrigerant circuit.
- In case of damage to the refrigerant circuit, ventilate the area by opening all windows. Do not operate electrical equipment or any other equipment that may produce arcs, sparks or flames in the area. Contact your Fisher & Paykel trained and supported service technician immediately to arrange for the appliance to be repaired.
- Do not use electrical appliances inside the food storage compartments of the appliance, unless they are of the type recommended by the manufacturer.

SAFETY AND WARNINGS

Electrical

- This appliance must be installed in accordance with the installation instructions before use.
- To allow disconnection of the appliance from the supply after installation, incorporate a switch in the fixed wiring in accordance with the wiring rules.
- Never unplug your refrigerator by pulling on the power cord. Always grip the plug firmly and pull straight out from the outlet.
- Do not plug in any other appliance at the same power point as your refrigerator or use extension cords or double adapters or ungrounded (two prong) adapters.
- Repair or replace immediately all electric service cords that have become frayed or otherwise damaged. Do not use a cord that shows cracks or abrasion along its length or at either the plug or appliance end.
- If the power supply cord is damaged, it must only be replaced by your Fisher & Paykel trained and supported service technician because special purpose tools are required.
- When moving your appliance away from the wall, be careful not to roll over or damage the power cord.
- Follow the National Electrical Code and all local codes and ordinances when installing this product.
- Warning: Ground Fault Circuit Interrupters (GFCI) may trip during normal operation of your refrigerator and interrupt the power supply. The use of a GFCI is not recommended with this product.

IMPORTANT!

Your refrigerator is designed to operate for many years without the need for service checks. However, if your refrigerator is malfunctioning, have it attended to by your Fisher & Paykel trained and supported service technician as soon as possible. All electrical repairs must be carried out by an adequately trained service technician or qualified electrician.

Cleaning

- Many commercially available cleaning products contain solvents that may attack the plastic components of your refrigerator and cause them to crack.
- Avoid using anti-bacterial cleaning products on either the interior or exterior of the cabinet as they may cause rusting of metal components and cracking of plastic components.
- Please refer to the 'Cleaning and caring for your refrigerator' section of this user guide for further information.

SAFETY AND WARNINGS

Disposal

Extreme care must be taken when disposing of your old appliance to avoid hazards:

- The flammable refrigerant gas must be safely removed.
 - The thermal insulation foam in this appliance contains flammable insulation blowing gases, any exposed foam may be highly flammable and must be carefully treated during disposal.
 - The refrigerator doors and/or door panel set(s) should be removed and the shelves left in place so that children may not easily climb inside.
- Your Fisher & Paykel trained and supported service technician will be able to give advice on environmentally friendly methods of disposing of your old refrigerator or freezer.

Storing food and drinks

- Do not store explosive substances such as aerosol cans with a flammable propellant in this appliance.
- Never store volatile or flammable materials in your refrigerator as they may explode.
- Never freeze liquids in glass containers. Liquid expands during freezing, which may cause the container to explode.
- Never freeze carbonated drinks. They may explode.
- Do not consume food if it is too cold. Food removed from the freezer compartment may be cold enough to cause damage when brought into contact with bare skin, eg frozen ice cubes.

Power failure - food safety

- Do not refreeze frozen foods that have thawed completely. The food may be dangerous to eat. Follow the recommendations below if you discover food in your freezer has thawed:
 - Ice crystals still visible - food may be refrozen but should be stored for a shorter period than recommended.
 - Thawed but refrigerator cold - refreezing generally not recommended. Fruits and some cooked food can be refrozen but use as soon as possible. Meat, fish, poultry - use immediately or cook then refreeze. Vegetables - discard as they usually go limp and soggy.
 - Thawed and warmer than 41°F (5°C) - discard all food.

SAFETY AND WARNINGS

Water filter

IMPORTANT!

- The water connection to your Ice & water refrigerator must be installed by an qualified plumber or Fisher & Paykel trained and supported service technician and comply with all state and local laws.
- Installation and use **MUST** comply with all state and local plumbing codes. Check with your local public works department for plumbing codes. You must follow their guidelines as you install the water filtration system.
- To avoid serious illness or death, only connect your water filter to safe drinking water.
- The water filter cartridge needs to be changed when the replacement indicator icon illuminates. This will happen every 6 months.
- If the water filtration system has been allowed to freeze, replace filter cartridge. Failure to replace the disposable filter at recommended intervals may lead to reduced filter performance and failure of the filter, causing property damage from water leakage or flooding.
- In cases of excessively reduced filter life—we recommend that you consult a local plumber or your water supplier for advice on suitable filtration requirements for the water supplied to your home.
- Filter replacement is the consumer's responsibility and will not be covered by the warranty except in the case of faulty parts or materials within the filter cartridge.
- If the water has not created ice for some time or ice has an unpleasant taste or odour dispose of ice and refer to 'Automatic ice' for flushing instructions. If unpleasant taste or odour persists, you may wish to fit a new filter cartridge.
- Use new tubing supplied with the refrigerator. **DO NOT** reuse old tubing from old water and ice connections.
- Your water filtration system can withstand up to 120psi (827kPa) of water pressure. Ensure the supplied pressure reducing valve is installed before installing the water filtration system. **DO NOT** install if water pressure exceeds 120psi (827kPa).

To reduce the risk associated with property damage due to water leakage or flooding:

- **DO NOT** install systems in areas where ambient temperatures may go above 100°F (38°C) or drop below 33°F (0.6°C).
- **DO NOT** install on hot water supply lines. The maximum operating water temperature of this filter system is 100°F (38°C).
- **DO NOT** install where water hammer conditions may occur. If water hammer conditions exist, you must install a water hammer arrester.

SAFETY AND WARNINGS

WARNING!

To reduce the risk associated with choking:

- **DO NOT** allow children under 3 years of age to have access to small parts during the installation of the water filter.

Ice making

IMPORTANT!

- Avoid contact with the moving parts of the ice maker ejector mechanism, and do not place your fingers on the automatic ice- making mechanism while the appliance is in operation.
- Do not use ice cubes that may have become discoloured, usually with a green-blue colour. If such discolouration is noted, discard the ice cubes and contact your Fisher & Paykel trained and supported service technician.

INSTALLATION INSTRUCTIONS

Please follow the installation steps below to ensure your appliance operates correctly.

1. Power

- The appliance must be installed so the plug is accessible.
- To ensure that the appliance is not accidentally switched off, connect your refrigerator to its own power point. Do not plug in any other appliance at this power point or use extension cords and double adaptors, as the combined weight of both power cords can pull the double adaptor from a wall outlet socket.
- For power requirements, refer to the information on the serial plate located at the front bottom right-hand side of the refrigerator when the door is open.
- It is essential that the appliance is properly grounded (earthed).

2. Location

- Your refrigerator should not be located in direct sunlight or next to any heat generating appliance such as a cooktop, oven or dishwasher.

3. Ice & Water and Automatic Ice models

- Your Ice & Water and Automatic Ice refrigerator must be installed by an authorized plumber or Fisher & Paykel trained and supported service technician as incorrect plumbing can lead to water leaks.
- Fisher & Paykel Appliances does not accept responsibility for damage (including water damage) caused by faulty installation or plumbing.

INSTALLATION INSTRUCTIONS

4. Product and cabinetry dimensions

If integrating your refrigerator, please follow installation instructions provided with the integration kits.

Freezer door models (RF135B and RF170B)
(Ice & Water, Automatic Ice and non-Ice & Water models)

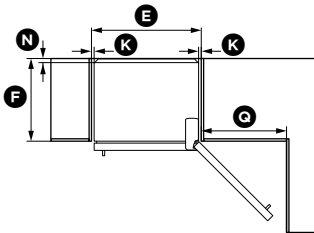
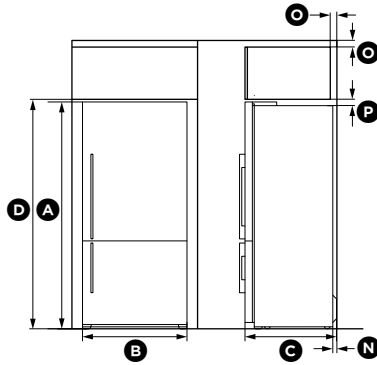

Flush with refrigerator chassis – full door rotation

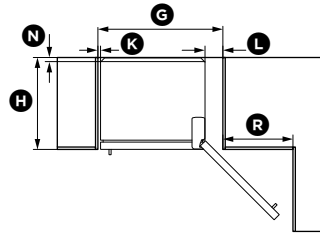

Flush with refrigerator door – full door rotation

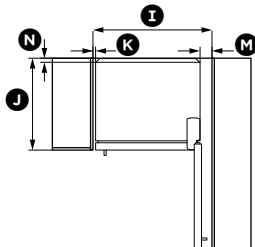

Flush with refrigerator door – 90° door rotation

INSTALLATION INSTRUCTIONS

	RF135B	RF170B
PRODUCT DIMENSIONS	inches (mm)	inches (mm)
(A) Overall height of product	67 3/4" (1720)	67 3/4" (1720)
(B) Overall width of product	25" (635)	31 1/8" (790)
(C) Overall depth of product (excludes handle, includes rear compartment cover)	27 3/8" (695)	27 3/8" (695)
CABINETRY DIMENSIONS (including minimum clearances)	inches (mm)	inches (mm)
(D) Inside height of cavity	68 1/8" (1730)	68 1/8" (1730)
Flush with refrigerator chassis – full door rotation		
(E) Inside width	26 9/16" (675)	32 11/16" (830)
(F) Inside depth	24 7/16" (620)	24 7/16" (620)
Flush with refrigerator door – full door rotation		
(G) Inside width	31 1/8" (790)	37 3/16" (945)
(H) Inside depth flush to door	27 3/8" (695)	27 3/8" (695)
Flush with refrigerator door – 90° door rotation (for full drawer/shelf access, the doors need to be open past 90°)		
(I) Inside width	29 5/16" (745)	35 7/16" (900)
(J) Inside depth flush to door	27 3/8" (695)	27 3/8" (695)
MINIMUM CLEARANCES	inches (mm)	inches (mm)
(K) Side clearance	13/16" (20)	13/16" (20)
(L) Side clearance – hinge side flush with door – full rotation	5 5/16" (135)	5 5/16" (135)
(M) Side clearance – hinge side flush with door – 90° rotation	3 9/16" (90)	3 9/16" (90)
(N) Rear clearance (incl. rear compartment cover)	1 3/16" (30)	1 3/16" (30)
(O) Vent – around top of cupboard (optional)	2" (50)	2" (50)
(P) Top clearance – above refrigerator cabinet	2" (50)	2" (50)
(Q) Door clearance – hinge side flush with chassis – full rotation	20 1/2" (520)	25 3/8" (645)
(R) Door clearance – hinge side flush with door – full rotation	15 15/16" (405)	20 7/8" (530)

INSTALLATION INSTRUCTIONS

4. Product and cabinetry dimensions

If integrating your refrigerator, please follow installation instructions provided with the integration kits.

Freezer drawer models (RF170W, RF170A, RF201A)
(Ice & Water, Automatic Ice and non-Ice & Water models)

RF170W

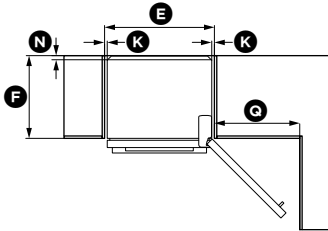
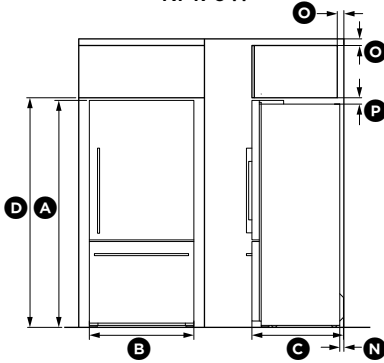

Flush with refrigerator chassis – full door rotation

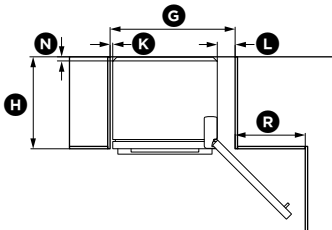

Flush with refrigerator door – full door rotation

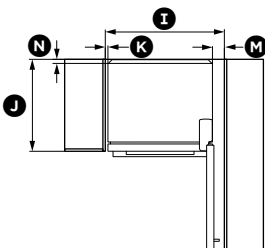

Flush with refrigerator door – 90° door rotation

RF170A, RF201A

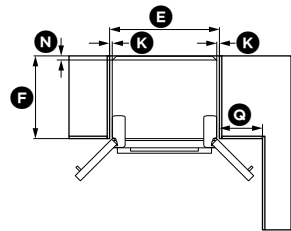
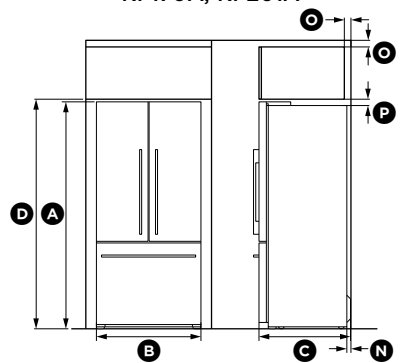

Flush with refrigerator chassis – full door rotation

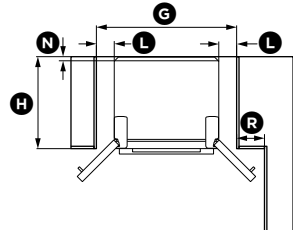

Flush with refrigerator door – full door rotation

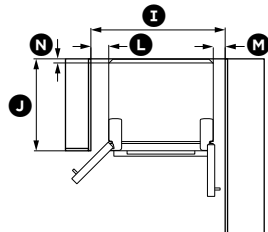

Flush with refrigerator door – 90° door rotation

INSTALLATION INSTRUCTIONS

	RF170W	RF170A	RF201A
PRODUCT DIMENSIONS	inches (mm)	inches (mm)	inches (mm)
(A) Overall height of product	67 3/4" (1720)	67 3/4" (1720)	70 3/4" (1800)
(B) Overall width of product	31 1/8" (790)	31 1/8" (790)	35 7/16" (900)
(C) Overall depth of product (excludes handle, includes rear compartment cover)	27 3/8" (695)	27 3/8" (695)	27 3/8" (695)
CABINETRY DIMENSIONS (including minimum air clearances)	inches (mm)	inches (mm)	inches (mm)
(D) Inside height of cavity	68 1/2" (1740)	68 1/2" (1740)	71 7/16" (1815)
Flush with refrigerator chassis — full door rotation			
(E) Inside width	32 11/16" (830)	32 11/16" (830)	37" (940)
(F) Inside depth	24 7/16" (620)	24 7/16" (620)	24 7/16" (620)
Flush with refrigerator door — full door rotation			
(G) Inside width	37 3/16" (945)	41 3/4" (1060)	46 1/16" (1170)
(H) Inside depth flush to door	27 3/8" (695)	27 3/8" (695)	27 3/8" (695)
Flush with refrigerator door — 90° door rotation (for full drawer/shelf access, the doors need to be open past 90°)			
(I) Inside width	35 7/16" (900)	39 15/16" (1015)	44 5/16" (1125)
(J) Inside depth flush to door	27 3/8" (695)	27 3/8" (695)	27 3/8" (695)
MINIMUM CLEARANCES	inches (mm)	inches (mm)	inches (mm)
(K) Side clearance	13/16" (20)	13/16" (20)	13/16" (20)
(L) Side clearance — hinge side flush with door — full rotation	5 5/16" (135)	5 5/16" (135)	5 5/16" (135)
(M) Side clearance — hinge side flush with door — 90° rotation	3 9/16" (90)	3 9/16" (90)	3 9/16" (90)
(N) Rear clearance (incl. compartment cover)	1 3/16" (30)	1 3/16" (30)	1 3/16" (30)
(O) Vent — around top of cupboard (optional)	2" (50)	2" (50)	2" (50)
(P) Top clearance — above refrigerator cabinet	2" (50)	2" (50)	2" (50)
(Q) Door clearance — hinge side flush with chassis — full rotation	25 3/8" (645)	12 13/16" (325)	14 3/8" (365)
(R) Door clearance — hinge side flush with door — full rotation	20 7/8" (530)	8 1/4" (210)	9 13/16" (250)

INSTALLATION INSTRUCTIONS

5. Rear compartment cover dimensions

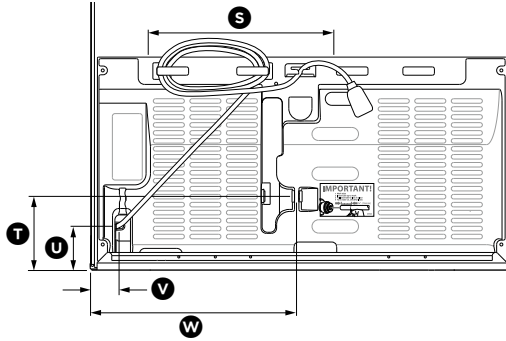

110VAC cord and water inlet dimensions

110VAC AND WATER INLET DIMENSIONS	RF135B	RF170W	RF170B RF170A	RF201A
	inches (mm)	inches (mm)	inches (mm)	inches (mm)
Ⓢ Power cord	40" (1016)	40" (1016)	40" (1016)	40" (1016)
Ⓣ Water inlet to bottom	5" (127)	5" (127)	5" (127)	5" (127)
Ⓤ 110VAC to bottom	3" (76)	3" (76)	3" (76)	3" (76)
Ⓥ 110VAC to edge	2" (51)	2" (51)	2" (51)	2" (51)
Ⓦ Water inlet to edge	13" (330)	16" (406)	16" (406)	18" (457)

INSTALLATION INSTRUCTIONS

6. Connecting water (Ice & Water and Automatic Ice models)

Contents of filter kit

- A** 1 x faucet connection
- B** 1 x short tubing
- C** 1 x locking key
- D** 1 x pressure reducing valve (PRV)
- E** 1 x water filter cartridge
- F** 1 x wall mounting bracket, filter head and tubing
- G** 2 x screws

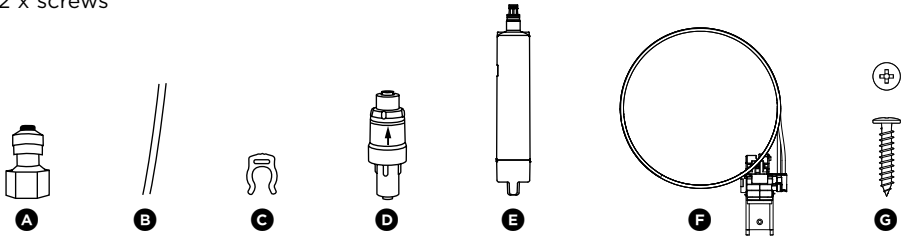

IMPORTANT!

- A pressure reducing valve (PRV) must be fitted prior to the water filter. The PRV protects your refrigerator from damage. If the PRV is not fitted to the connection line your warranty will be void and the product may leak.
- The water connection instructions below are intended only for the professional installer.
- The new tubing supplied with the refrigerator is to be used, old tubing from old water and ice connections should not be used.
- Ensure the inlet tubing is correctly connected to the PRV. Failure to do so may result in serious injury.
- Replacement parts are available through Customer Care or online at fisherpaykel.com (this service is available to selected markets only).

INSTALLATION PRECAUTIONS/WARNING

- DO NOT cut any length of tube shorter than 19 11/16" (500mm).
- DO NOT install near electrical wires or water pipes that will be in the path of drilling when selecting the location of filter system.
- DO NOT mount the water filter in such a position so that it will be struck by other items, such as wastebaskets.
- DO NOT install the water filter or any water tubing in direct sunlight as prolonged exposure to light can weaken plastic components.
- DO NOT install in a location that is susceptible to freezing temperatures as damage to the housing could occur.
- DO NOT screw water filter mounting bracket to the refrigerator.
- DO NOT install the filter or any water tubing in high temperature areas eg in a ceiling cavity.
- AVOID contamination of pipes during installation.
- DO NOT continuously dispense water for longer than 2 minutes.

INSTALLATION INSTRUCTIONS

Installation instructions:

- 1 Ensure the refrigerator is NOT plugged into a power supply.
- 2 Locate a cold water supply/feed that is suitable for a water connection.
- 3 Connect the faucet connection fitting (A) to the faucet. Connect the short tubing (B) to the outlet of the faucet and secure with the locking key (C) (refer to Diagram 1)
- 4 Connect the inlet of the PRV (D) to the tubing connected to the faucet (refer to Diagram 2). Ensure the arrow on the PRV is pointing away from the faucet. The arrow indicates the direction of water flow.
- 5 Connect the inlet tube from the filter head to the PRV (refer to Diagram 3). The inlet tube can be identified by the downward arrow ↓ on the filter head and a red mark on the tube.

IMPORTANT!

Ensure the outlet tubing is correctly connected to the refrigerator water valve. Refer to Diagram 3.

- 6 Determine the mounting position for the water filter noting the following:
 - The water filter MUST not be mounted with the filter head position below the base of the filter (refer to Diagram 4). We recommend fitting the water filter in a vertical orientation with the filter head at the top. This will minimise water leakage during replacement of the water filter.
 - Ensure the water filter is in a convenient location to access every 6 months for replacement. We recommend that this location is beside the water filter supply faucet in a cupboard beside the refrigerator.
 - A minimum clearance of 2" (50mm) from the bottom of the water filter is required to perform filter removal.

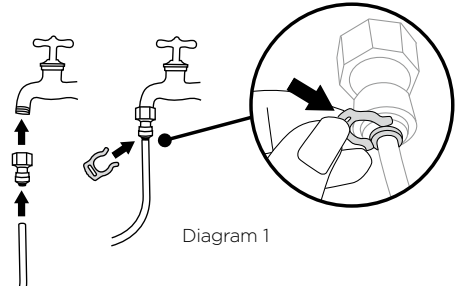

Diagram 1

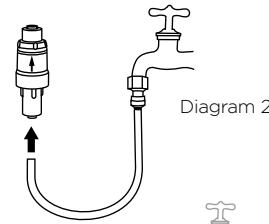

Diagram 2

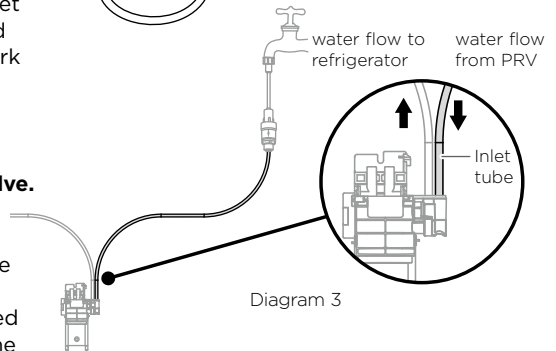

Diagram 3

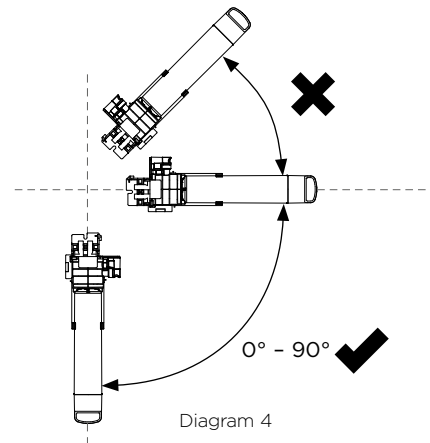

Diagram 4

INSTALLATION INSTRUCTIONS

⑦ Attach the wall mounting bracket with the two screws provided, attach the bottom screw first then the top screw (refer to Diagram 5).

⑧ Insert the filter head. Push the filter firmly into the filter head and turn in a clockwise direction until it locks into place (refer to Diagram 6).

⑨ **To flush the water filter of any trapped air, harmless carbon fines and check for leaks:** Aim the end of the filter outlet tubing into a bucket, turn on the faucet and run 2 gal (8L) of water through. Once complete, turn the faucet off.

Note: Further flushing is required before first use of your ice or water functions, please refer to 'Before you start using the Ice & Water or Automatic Ice function' for details.

⑩ Run the 1/4" (6mm) tubing to the back of the refrigerator ensuring there is enough tubing to pull the refrigerator out for service.

⑪ Using the measurement guide shown in Diagram 7, mark out 5/8" (16mm), on the end of the tubing as shown in Diagram 8.

⑫ Insert the outlet tubing to the water (solenoid) valve up to the marked line. The outlet tube can be identified by the upward arrow ↑ on the filter head and a blue mark on the tube.

⑬ Pull gently on tubing to ensure it is locked in as shown in Diagram 10.

⑭ Turn the faucet on and check that all connections are dry and free of drips.

⑮ Coil water line tubing behind the refrigerator. Push your refrigerator into place being careful not to kink or squash the water line tube.

⑯ Read pages 16 – 17 carefully and then turn refrigerator on.

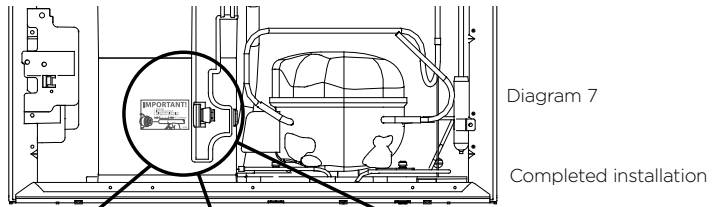
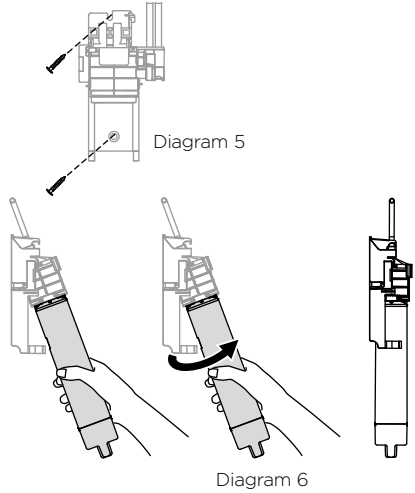

INSTALLATION INSTRUCTIONS

IMPORTANT!

- All connections must be checked for leaks.
- Ensure 1/4" (6mm) tubing is routed away from sharp objects, sharp corners (beware of kinking the tube as this will stop water flow), clear of the refrigerator rear compartment and not in a location where it can be kinked or squashed.
- Ensure all push-fit connections are firmly pushed into place. The tube should push in 5/8" (16mm) before reaching the stop.
- If tubing is removed at any point, re-cut the end and re-insert. Tubing must be fully inserted to avoid leaks.
- To remove tube from connection points first turn off the isolating faucet. Gently push the dispensing pad a few times using a glass or container to remove the static line pressure. Push in the collet firmly while pulling back on the tubing at the same time, as shown in Diagram 11.

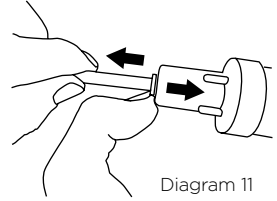

Diagram 11

847200 - Certified by: IAPMO R&T against NSF/ANSI Standards 43, 53, 401 and CSA B4831.1 for the reduction of claims specified on the performance data sheet and at iapmort.org. 847200 compounds certified under NSF/ANSI 401 have been deemed as incidental contaminants/emerging compounds. Incidental contaminants are those compounds that have been detected in drinking water supplies at trace levels. While occurring at only trace levels, these compounds can affect the public acceptance of drinking quality water."

847201 - Certified by: IAPMO R&T against NSF/ANSI Standards 43 and CSA B4831.1 for the reduction of claims specified on the performance data sheet and at iapmort.org.

Rated capacity:

847200 - 102 gallons (386 litres)

847201 - 170 gallons (643.5 litres)

INSTALLATION INSTRUCTIONS

Before you start using the Ice & Water or Automatic Ice function

- Check your refrigerator is switched on.
- Allow at least 2 hours for your refrigerator to cool before use.
- Complete all the flushing steps detailed in this installation/user guide to ensure optimum performance of your water filter.





For Ice & Water models only:

- ① Press the water dispenser pad to dispense 1/2 gal (2L) of water.
 - There may be carbon residue dispensed together with water. This is not harmful, and normal during flushing process.
- ② Wait for 2 minutes before dispensing again.
- ③ Dispense another 1/2 gal (2L) of water. Your water dispenser is now ready for use.
- ④ Water will continue to drip from the dispenser for a few more days after installation to clear remaining trapped air in the dispenser. Check the drip tray regularly and empty when required.



Water dispenser

For Ice & Water and Automatic Ice models:

- ① Turn the ice maker on by pressing the  button. The light above the  button will be illuminated when the ice maker is on.
- ② Press the ,  and  together for 4 seconds then close the doors. The ice tray will empty the water into the bin below. The ice tray will only empty after the doors are closed.
- ③ Repeat step ② to remove dust in the ice tray collected during manufacture and transport.
- ④ Empty the water, dry the bin and return it correctly (refer to diagrams 1 and 2 for placement of ice bins for your refrigerator).
- ⑤ Once your ice maker is turned on the first bin of ice may be discoloured, this is not harmful and normal during the flushing process. Discard the first full bin of ice made. Your ice maker is now ready for use.
 - **For Ice & Water models:** the water filter will reach optimum performance after two to three full bins of ice.
 - **For Ice only models:** the water filter will reach optimum performance after four to five full bins of ice.

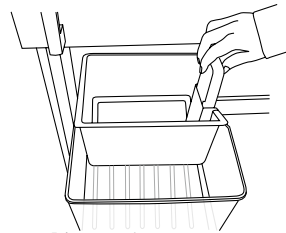

Diagram 1

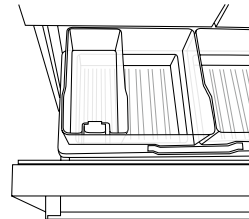

Diagram 2

Ice storage bin and scoop in correct position

INSTALLATION INSTRUCTIONS

7. Installation (all models)

Your Fisher & Paykel ActiveSmart™ refrigerator is fitted with front and rear rollers, designed for moving the product in the forwards and backwards direction.

Avoid moving the product in a sideways direction as this may damage the rollers or the floor covering/surface.

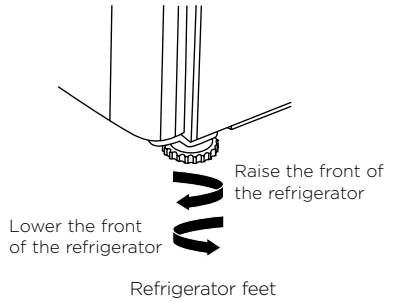

- (A) Your refrigerator will arrive with the front feet wound up making moving the product into its final location a simple task.
- (B) Roll the refrigerator into its final position making sure there is the correct air gap between the product and surrounding cabinetry. See minimum clearance in cabinetry dimensions table.
- (C) Adjust the front feet down until the refrigerator is leaning backward with the front approximately 1/2" (10mm) higher than the back. This will ensure a good door closing action.

(Non French door models only)

- (D) Aligning your refrigerator with cabinetry.
 - Align the sides of the refrigerator with the cabinetry by adjusting the hinge side front foot.
 - Adjust the handle side foot until it touches the floor and takes a small amount of weight.
 - Once the refrigerator is in place and aligned with cupboards/alcove gently push on the front top and check if the product is rocking or stable.

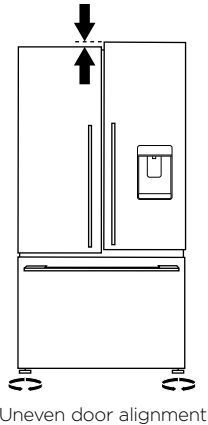

8. Levelling of refrigerator doors (French door models only)

- For uneven surfaces, front feet can be used to align the 2 doors.
- If left hand door is too low, then unscrew the left hand foot to lift up the cabinet until the two doors top edges are aligned.
- If right hand door is too low, then adjust the right hand foot in the same way.

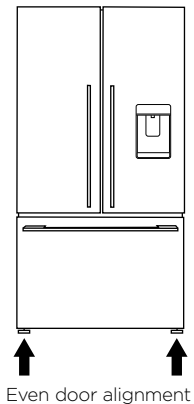

INSTALLATION INSTRUCTIONS

9. What to do if your product is unstable

- (A) Gently push the refrigerator back until the rear rollers contact the floor.
- Measure the gap under the front foot, which has come off the floor.
 - Obtain some solid packing material (hardwood, plastic, etc) which fits firmly into the gap under the foot.

Note: do not use metallic materials that may corrode, stain and/or damage floor coverings.

- (B) Wind both front feet up and roll the product out of position.
- Place the packing material in the location diagonally opposite the front roller that lifts off the floor.
 - Make sure the packing material stays in place when the product is pushed back into position.
 - Ideally, the packing material is large enough to rest against the back wall so as to prevent it from moving when the cabinet is pushed into position.

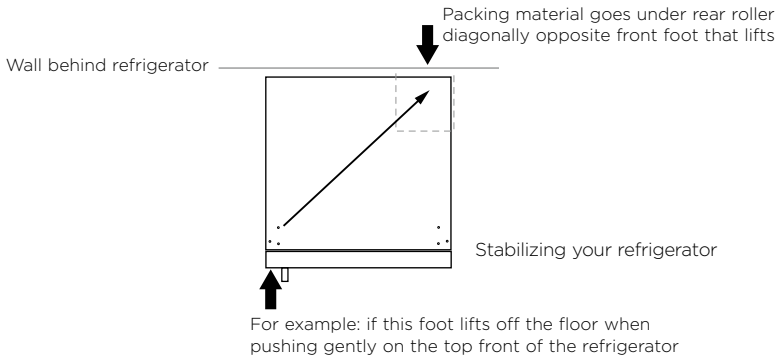
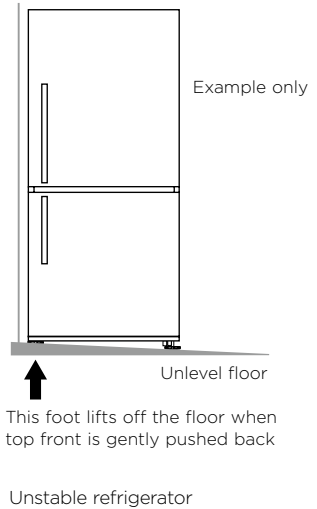

- (C) Roll the refrigerator back into position and adjust front feet as per step 7(C). (Check alignment and door closing action are satisfactory).
- Make small adjustments to front feet where necessary.
 - Check that the product is stable (all 4 feet are on the floor). If not, repeat 9(A) and 9(B).

INSTALLATION INSTRUCTIONS

Before placing food in the fresh food or freezer compartments

- Remove all internal packaging. Ensure that all transit clips are removed from the refrigerator. These are small rubber stoppers located at the back of the shelves.
- Clean the inside of the appliance with a mix of warm water and a small amount of liquid detergent, and a soft cloth to remove manufacturing and transportation dust.
- Allow the refrigerator and freezer to run empty for 2 - 3 hours to allow each compartment to cool to the appropriate temperature.
- The appliance may have an odor on its initial operation, but this will go when the refrigerator and freezer have cooled sufficiently.

Energy efficiency

For the most energy efficient use of your appliance:

- Ensure your refrigerator has adequate ventilation.
- Do not cover your appliance with any material that will prevent air from flowing around the cabinet sides.
- Ensure you vacuum around the appliance to remove dust and possible pet hair accumulation. Also keep the appliance and it's cabinetry free of dust by wiping down with a dry, lint-free cloth (refer to section 'Cleaning and caring for your refrigerator', 'Cabinet surround').
- Allow good clearances in front of air ducts within the cabinet for maximum cold air distribution.
- Cool hot foods down before placing them in the appliance.
- Do not overfill the compartments.
- Keep door openings to a minimum.
- Select a temperature setting that isn't too cold.
- Check your door seals for leaks.

MOVING OR STORING YOUR APPLIANCE

If your refrigerator is turned off for any reason, wait 10 minutes before turning it back on. This will allow the refrigeration system pressures to equalize before restarting.

Moving your refrigerator

- Turn off the appliance and unplug from the power point. Remove all food.
- Turn the adjustable feet to the right as far as they will turn.
- Ease the refrigerator out of its position. Tuck the power cord away, tape the shelves in place and tape the doors closed. If the cabinet needs to be placed at an angle or laid down, carefully lay it on its side (the right hand side when viewed from the front).
- Relocate and install. If the appliance has been left on its side for any length of time, leave it standing upright as long as you can (a few hours) before turning on.

Storing your refrigerator

- When storing your cleaned appliance, leave the doors open. This allows air to circulate and prevents the build up of bacteria and moulds.
- Before using again, clean well using a mixture of warm water and a small amount of liquid dishwashing detergent. Rinse with clean water and dry with a soft lint-free cloth.

Holiday time

We recommend you leave your refrigerator operating while you are on holiday.

ACTIVSMART™ OPERATING INSTRUCTIONS

Models:	25" (635mm) wide	RF135B
	31 1/8" (790mm) wide	RF170B, RF170W, RF170A
	35 3/8" (900mm) wide	RF201A

The control panel enables you to view and modify features and options on your refrigerator.

Temperature control (all models)

- The powerful cooling system will automatically cool both refrigerator and freezer compartments to their recommended ideal temperatures — 37°F (3°C) refrigerator and -1°F (-18°C) freezer. This will take between 2 - 3 hours.
- The two compartment temperatures are accurately and independently controlled and do not change with the temperature or humidity of the surroundings; whether summer or winter.
- If you wish to alter the temperature of either the fresh food compartment or freezer compartment, this can be easily done by using the internal control panel located at the front right of the refrigerator compartment.

Internal control panel to adjust temperatures

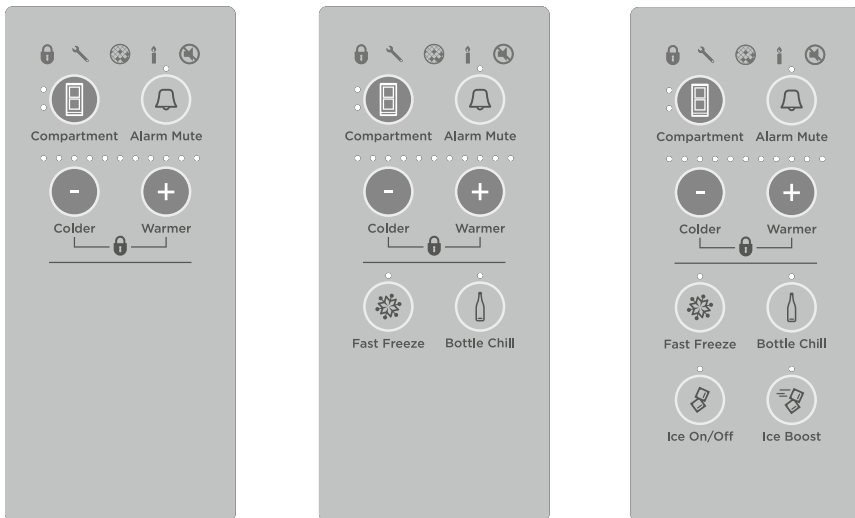



Control panel variants for ActiveSmart™ refrigerators. Extra features available on selected models.

Fresh food compartment (all models)



- The fresh food compartment light will automatically be illuminated. The temperature for this compartment will show as a series of lights.
- The temperature may be altered by pressing the **-** or **+** buttons. One press on either of these buttons will reduce or increase the number of lights by one which indicates a small change in temperature.
- Fewer lights illuminated means a cooler temperature for the compartment selected.

Freezer food compartment (all models)

- To adjust the freezer temperature press the  button once so the freezer compartment light is illuminated.
- The freezer temperature can be altered by pressing the **=** or **+** buttons.
- One press on either of these buttons will reduce or increase the number of lights illuminated which indicates a small change in temperature.
- Fewer lights illuminated means a cooler temperature for the compartment selected. Note: successively pressing the  button will automatically scroll between the compartments.
- When the door is re-opened the control panel will return automatically to the fresh food compartment setting.

Alarm Mute (all models)

For times when you require the door to be open longer than normal eg when cleaning the interior of your refrigerator press the 'Alarm Mute' button to silence the door alarm for 20 minutes.

- To activate, press the  button once. The 'Alarm Mute' light will be illuminated when the function is activated.
- 'Alarm Mute' will deactivate after 20 minutes and the door alarms will return to normal.
- To deactivate 'Alarm Mute' manually, press the  button again. When 'Alarm Mute' is deactivated the light is off.

Note: when the fresh food or freezer compartment door is left open for long periods of time food quality and/or safety may be compromised.





Door alarms (all models)

- If the fresh food compartment door is left open the alarm will beep after 90 seconds and if the freezer door is left open the alarm will beep after 60 seconds.
- While either door remains open, subsequent beeps will sound every 30 seconds for 5 minutes.
- A continuous alarm will sound if either of the doors have been left open for 5 minutes or longer and the interior compartment light(s) will turn off. The alarm will stop only when the door(s) is closed.

Note: if 'Alarm Mute' has been activated the door alarms will be silenced for 20 minutes. After 5 minutes of the doors being left open the compartment light will turn off however the normal door alarms will be suspended. The 'Alarm Mute' light will be illuminated to indicate that the appliance is in this mode.







Key Mute (all models)

'Key Mute' allows you to silence all button presses.



- To activate 'Key Mute' and silence buttons, press and hold the  button for 4 seconds.
- The  icon on the internal control panel will be illuminated.
- The keys will be silenced when 'Key Mute' is activated.
- Door alarms and 'Bottle Chill' alarm will still operate.
- 'Key Mute' will not automatically deactivate. To manually deactivate, press and hold the  button for 4 seconds.
- The  icon will no longer be illuminated.

Key Lock (all models)





'Key Lock' allows you to disable the buttons on the internal control panel. This is useful when cleaning your refrigerator.

- To activate 'Key Lock' press and hold the  and  buttons for 4 seconds.
- The  icon on the internal control panel will be illuminated.
- Pressing any of the buttons will cause a raspberry beep to tell you that they are disabled.
- 'Key Lock' will not automatically deactivate. To manually deactivate, press and hold the  and  buttons for 4 seconds.
- The  icon will no longer be illuminated.

Sabbath mode activation (all models)

- To activate 'Sabbath mode', open the door(s) of the fresh food compartment and freezer compartment and then press and hold the ,  and  buttons on the internal control panel for 4 seconds.
- The candle icon will illuminate when 'Sabbath mode' has been activated.







When the product is in Sabbath mode:

- The  icon on the internal control panel will be illuminated.
- All lights on the internal control panel except for the candle icon will be off.
- The fresh food or freezer compartment lights will not operate when the door(s) is opened.
- The door alarms will not operate.
- The internal control panel will not function except to indicate 'Sabbath mode' is active as stated above.
- Opening the door(s) will not affect the compressor or fans.
- If the power to the refrigerator is turned off whilst in this mode, the product will continue in 'Sabbath mode' when the power is restored.
- 'Sabbath mode' will automatically de-activate 80 hours after activation.
- To de-activate earlier than 80 hours press and hold the ,  and  buttons for 4 seconds. The candle icon will no longer illuminate on the internal control panel (and external display for Ice & Water models) and functionality of the internal control panel will return to normal.

Special Functions



Bottle Chill (selected models only)

This function allows you to chill your beverages more rapidly in the freezer without the worry of forgetting them. The timer is set for 15 minutes however the time taken to chill depends on the size of your beverage. If after 15 minutes your beverage is not cold enough, simply place it back in the freezer and reset the 'Bottle Chill' function.

- To activate, press the  button on the internal display. The 'Bottle Chill' light will be illuminated when the function is activated. The  icon will be illuminated on the external display (Ice & Water and Automatic Ice models only).
- An alarm will sound after the 15 minute time has elapsed.
 - **For non-Ice & Water models:** open the fresh food compartment door and press the  button on the internal control panel to silence the alarm.
 - **For Ice & Water models:** the  icon will flash on the external display. Press the  button on the external display to silence the alarm.
- Remember to remove your beverage from the freezer.
- To deactivate 'Bottle Chill' before 15 minutes has elapsed, press the  button again on the internal control panel. When 'Bottle Chill' is deactivated the light is off and the  icon is not visible on the external display (Ice & Water and Automatic Ice models only).





Fast Freeze (selected models only)

We have created the 'Fast Freeze' feature to help you get the best possible results when freezing fresh food. 'Fast Freeze' boosts the freezing speed by dropping the freezer to its coldest temperature for 12 hours, which helps to ensure vital freshness, texture and taste are retained during the freezing process.

- To activate, press the  button on the internal display. The 'Fast Freeze' light will be illuminated when the function is activated.
- To deactivate before the 12 hours has elapsed, press the  button again. When 'Fast Freeze' is deactivated the light is off.
- For best results we recommend that you activate the function before it is required. Alternatively, activate it when placing food into the freezer.

Ice boost function (selected models only)

This function is designed to be used for times when you require more ice eg when you are having a party. The 'Ice Boost' function will increase ice production up to 30% from standard ice making and deactivate automatically after 24 hours.

- When you first turn your ice maker on, the 'Ice Boost' function will be off.
- To turn this function on, press the  button. The light above the  button will be illuminated when the 'Ice Boost' function is on.
- The 'Ice Boost' function is paused once your ice bin is full.
- To manually deactivate this feature press the  button again. The light above the  button will be off when the 'Ice Boost' function is off.
- Activating the 'Ice Boost' function will automatically turn ice making on.
- Deactivating ice making will automatically deactivate the 'Ice Boost' function.



ALL ABOUT THE EXTERNAL DISPLAY (ICE & WATER MODELS ONLY)

This screen enables you to lock the water dispenser, indicates to you when 'Bottle Chill' is activated and when your water filter requires changing.



Electronic external display

EXTERNAL DISPLAY FEATURES

 Lock	Dispenser lock button and LED light	Locks/unlocks the water dispenser. When locked the LED above the button will illuminate.
	Bottle Chill indicator	Icon will illuminate indicating when 'Bottle Chill' is activated and flashes when beverage is ready.
	Filter change indicator	Icon will illuminate indicating when water filter requires changing.

USING YOUR WATER DISPENSER (ICE & WATER MODELS ONLY)

Dispensing

- Your water dispenser has been designed for one-handed operation.
- To dispense water push the dispensing pad gently, using a glass or container. This pad requires only a gentle press to activate.
- To stop the flow of water, simply pull your glass away from the dispensing pad.

Please remember that pressing very hard against the dispensing pad will not encourage the dispenser to operate faster or produce greater quantities of water.



Water dispenser

First use

Before using your water dispenser, the water filter must be installed and flushed to remove any impurities or trapped air in the filter system. Refer to 'Before you start using the Ice & Water or Automatic Ice function' for details.



IMPORTANT!

To avoid damage to property or personal injury do not put hands, fingers or objects up the dispenser opening.

Please note that once installation is complete a few drips may appear out of the dispenser over the next few days as the remaining trapped air is cleared.

Dispenser Lock

The 'Dispenser Lock' prevents water from being dispensed. This is useful when you are cleaning the external display or when there are small children around.

- Press and hold the  button for 4 seconds to activate 'Dispenser Lock'.
- The light above the 'Dispenser Lock' icon will be illuminated.
- Pressing the water dispenser pad will cause a raspberry sound indicating to the user that water cannot be dispensed.
- To de-activate the 'Dispenser Lock', press and hold the  button for 4 seconds. The light above the 'Dispenser Lock' icon will no longer be illuminated and water dispensing will be enabled.

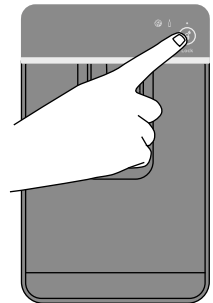

Dispenser Lock



WATER FILTER (ICE & WATER AND AUTOMATIC ICE MODELS ONLY)

All the water to your refrigerator is filtered to remove impurities through a filter cartridge located in a position of your choice outside the refrigerator. This will need changing approximately every 6 months.

- There is a replacement indicator icon  on the internal control panel (Ice & Water and Automatic Ice models) and external display (Ice & Water models only) which will appear when the filter needs replacing. It will flash, as a reminder, when water is dispensed.
- Replacement filter cartridges can be purchased online from fisherpaykel.com or by calling Fisher & Paykel Customer Care. Details of the replacement filter cartridge are labelled on the cartridge. Instructions on how to install your replacement water filter are provided with the filter.







To reset the filter indicator

IMPORTANT!

- **We recommend the water filter to be used from the time of installation.**
- **Do not reset indicator before filter is changed or filter monitoring will be inaccurate.**
- Press and hold  and **+** for 4 seconds to reset the internal and external filter indicators.
- The  icon on the internal and external displays will turn off when reset.

To disable the filter indicator

Note: if disabled, you will not be reminded to next change your filter.

- When no filter is fitted, you can disable the filter indicator.
- Press and hold ,  and **+** for 4 seconds to turn this feature off, the  icon will flash once on the internal and external displays.
- We recommend that you do not disable the filter indicator if you have a filter fitted to the connection.
- To turn this feature on press and hold ,  and **+** for 4 seconds, the  icon on the internal and external displays will flash twice.

USING YOUR ICE MAKER (ICE & WATER AND AUTOMATIC ICE MODELS ONLY)

Ice On/Off

Your ice maker is designed to automatically dispense ice until it senses that the bin is full. So the more ice you use, the more it makes.

To turn your ice maker on, press the  button. The light above the 'Ice On/Off' icon will be illuminated when the ice maker is on.

IMPORTANT!

Ensure all bins are in place when the ice making function is activated.

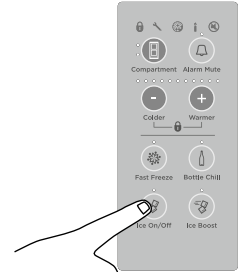

Turning ice maker on

First use

Before using your automatic ice maker, the water filter must be installed and flushed to remove any impurities or trapped air in the filter system. Refer to 'Before you start using the Ice & Water or Automatic Ice function' for details.

Turn your ice maker off if:

- There is no water supply for several hours.
- You are removing the ice storage bin for a period of time.
- You are going on holiday/vacation.

Information about your ice maker

- Your automatic ice maker will produce approximately eight cubes of ice every 3 - 4 hours, depending on the freezer compartment temperature and the number of door openings.
- When the 'Ice Boost' function is activated, ice production will increase up to 30% from standard ice making.
- The ice cube tray will fill with water.
- When cubes are frozen, they will be ejected from the ice tray into the ice storage bin.
- Ice making will continue until the storage bin is full.
- Ice making will resume once you start to use the stored ice.
- Your Ice & Water product comes with a smaller ice bin inside the larger freezer bin. Attached to the ice storage bin is the hygienic scoop for the ice. This scoop provides hygienic access to the ice.
- If a large amount of ice is required, remove an ice storage bin and allow ice to fall into the larger bin.
- For maximum ice storage, level the stored cubes with the ice scoop.
- If ice is not used often, old cubes will become cloudy, taste stale, will shrink and may stick together. Empty the ice storage bin periodically and wash in lukewarm water. Dry thoroughly and place back into the correct position.

Manual ice system (selected models only)

An ice storage bin which sits inside the upper top freezer bin provides storage for and gives you access to clean, clear ice cubes.

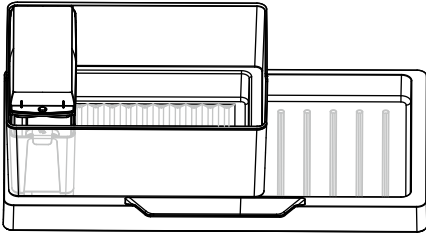

Upper left freezer bin, ice storage bin, ice tray, lid and scoop in correct position

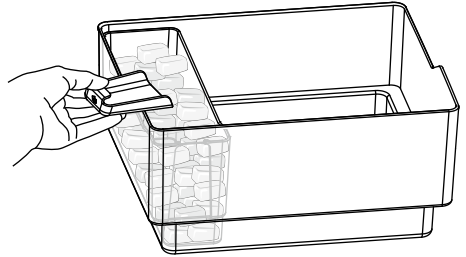

Accessing your ice

Information about your manual ice system

- To make ice, take the ice tray and lid from the top of the ice storage bin. Remove the lid from the ice tray and fill the tray with water. Place the lid back on the ice tray and carefully position it back onto the ice storage bin.
- Once the ice is solid, take the ice tray and lid off the ice storage bin, remove the lid from the tray and twist the ice tray at each end in opposite directions. Turn the ice tray over the ice storage bin to dislodge the cubes into the bin.
- Fill the ice tray with clean water and repeat to fill the ice storage bin.
- Attached to the ice storage bin is the ice scoop which provides hygienic access to ice.
- To access ice cubes, take the ice tray and lid from the top of the ice storage bin and place onto a flat surface. Take the scoop from the front of the bin, scoop cubes into vessel and then replace the scoop, tray and lid back to the top of the bin.
- For maximum ice storage, level the stored cubes around the bin with the ice scoop.
- If ice is not used often, old cubes will become cloudy, taste stale, will shrink and may stick together. Empty the ice storage bin periodically and wash in lukewarm water. Dry thoroughly and place back in the correct position.

Fruit and vegetable bins and humidity control lid

The fruit and vegetable bins feature a unique lid which provides two functions:

- The humidity lid seals the bins and provides a humid microclimate to extend storage times of fruit and vegetables.
- The humidity lid prevents condensation, which forms at high humidities, from dripping down onto the fruit and vegetables by retaining it in the grooves of the lid.

Fruit and vegetable bins and humidity slide (selected models only)

- Each fruit and vegetable bin has a humidity slide control that can be adjusted to a fruit or vegetable setting depending on what is stored in the bins.
- If possible try to store fruit and vegetables separately. This will help extend their storage life.
- If there is a mixture of fruit and vegetables in the bin adjust the position of the control to the center.
- If there is too much water in the bins (due to the high humidity in the bins), the control can be adjusted towards the setting with fewer drips (fruit setting) and/or the water can be wiped out as required.
- Remember a minimum amount of water in the bins is beneficial for fruit and vegetable storage.

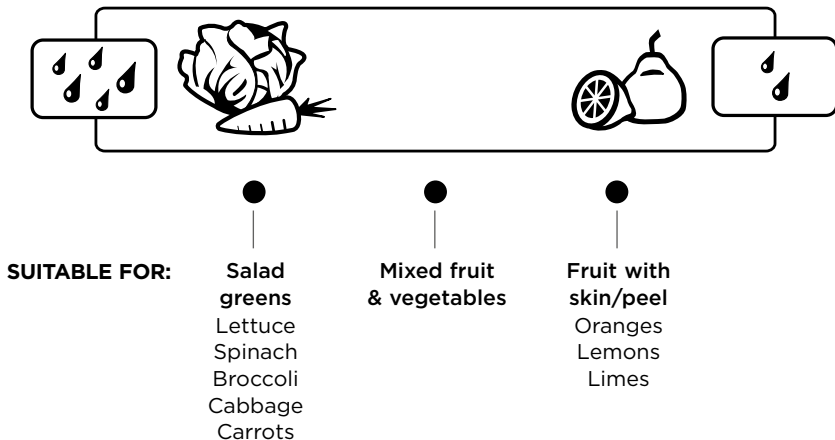

Humidity control graphic

Slim storage drawer (where fitted)

The slim bins at the bottom of the fresh food compartment provide storage space for items that you may want to keep separate from the rest of the refrigerator. These slim storage bins can be used for deli item storage, beverages or for defrosting foods.

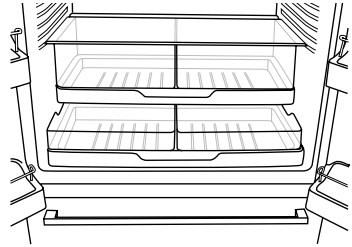

Slim storage drawer

Bottle holder (where fitted)

- The bottle holders can be used to store a variety of bottles.
- To position the bottle holder in your refrigerator, simply slot the back edge of the bottle holder onto the back trim of any shelf in the fresh food compartment.
- If you are not using all or some of the bottle holders, the unused bottle holders can be stacked up on top of one another so they do not take up unnecessary shelf space.
- Bottles are best stored with the neck of the beverage facing the front of the refrigerator.

Glass shelves

- Glass shelves can be repositioned in the cabinet as desired.
- Remove shelves by lifting up the back of the shelf and then pulling the shelf forward.

Drip tray (Ice & Water models only)

- The drip tray is designed to fit into the bottom of the water dispenser panel.
- To insert the tray always ensure that the rounded sides are fitted into the dispenser panel first.
- The purpose of the tray is to capture any odd drips of water that may fall after dispensing.
- The tray can be easily removed for cleaning.

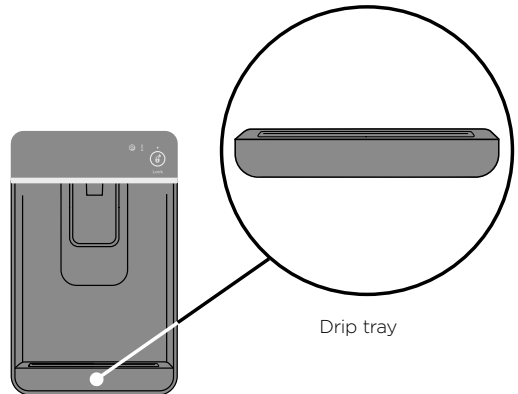

Drip tray

CLEANING AND CARING FOR YOUR REFRIGERATOR

Exterior (all models)

Stainless exterior doors

- Clean the exterior door with liquid dishwashing detergent dissolved in warm water and a soft cloth.
- Dry the door with a lint-free cloth.
- The use of any abrasive or stainless steel cleaners and solvents will damage the door surface.

Other exterior surfaces (all models)

- Clean all other exterior surfaces with a mix of warm water and liquid dishwashing detergent, and a soft cloth.
- If necessary, clean the magnetic door gasket, the center door gasket and the recessed handles with an old toothbrush, warm water and liquid dishwashing detergent.

Cabinet surround

- To maximize operating efficiency regularly vacuum the flooring around your appliance.
- Cleaning behind the appliance is required once or twice a year. More frequent cleaning may be necessary for dusty homes or those with pets shedding hair.
- To do this wind up the feet and carefully ease the refrigerator out of its position. Switch off and unplug.
- Vacuum the flooring behind your appliance and the rear compartment cover (where fitted) to remove dust accumulation. Use a dry lint-free cloth to clean the appliance walls and surrounding cabinetry.
- After cleaning, plug in and switch on. Push the appliance into position and wind feet down.

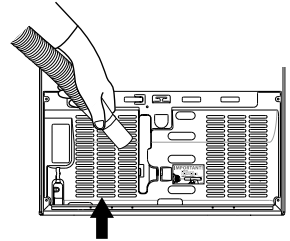

Cleaning the rear compartment cover

WARNING!

Electric Shock Hazard. Do not remove rear compartment cover. This may expose you to the risk of an electric shock.

Water dispenser pad and interface (Ice & Water models only)

- We have incorporated a Dispenser and 'Key Lock' function in your refrigerator to make cleaning easier. This will help you to avoid accidental water dispensing while you clean.
- Clean the pad and interface panel with a soft damp cloth.

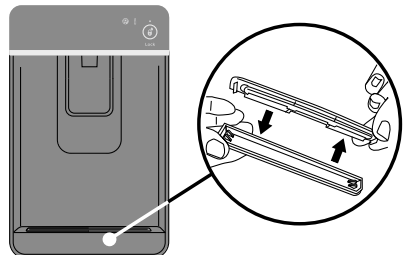

Cleaning the drip tray

Drip tray (Ice & Water models only)

- To clean, take the tray out of the dispenser panel and pull the two halves of the tray apart.
- Clean in warm water with a mild detergent. Dry and clip back together.

CLEANING AND CARING FOR YOUR REFRIGERATOR

Interior (all models)

- It is important to keep the interior of the refrigerator and freezer clean to help prevent food from becoming contaminated during storage.
- The amount and types of food stored determines how often cleaning should be carried out in the refrigerator (ideally once every 1 to 2 weeks).
- Remove the shelves from cabinet and door. Wash shelves and storage bins in warm water and detergent; rinse in clean water and dry before replacing.
- Wipe over the interior surfaces with warm water and liquid dishwashing detergent. Alternatively you can use 1tsp baking soda dissolved in 1/2qt (500ml) of warm water. Rinse with clean water.
- To help remove “old stale refrigerator” smells add a few drops of vanilla essence or vinegar to the water before cleaning.
- Clean interior surfaces with warm water and liquid dishwashing detergent. Use a toothbrush for the magnetic door gasket.
- Do not use harsh, abrasive cloths on any part of the refrigerator or freezer.

Glass shelves (all models)

Clean with warm water and detergent or a glass cleaner.

Bottle holder (where fitted)

Clean with warm water and detergent. The use of abrasive cleaners and solvents may cause damage.

Automatic ice dispenser (Ice & Water and Automatic Ice models only)

- We do not recommend you clean the ice maker componentry, but it is important to clean the bins occasionally.
- The storage bin should be cleaned regularly and the old ice in the bottom of the bin discarded.
- Wash bin in lukewarm water. Dry thoroughly and replace.
- When replacing the bin ensure that the scoop is on the right hand side or at the front of the bin (model dependent).

IMPORTANT!

Many commercially available cleaning products contain solvents that may attack the plastic components of your refrigerator and cause them to crack. It is important to use only warm water and a small amount of liquid dishwashing detergent on any components inside and outside your refrigerator. Avoid using anti-bacterial cleaning products on either the interior or exterior of the cabinet as they may cause rusting of metal components and cracking of plastic components.

CLEANING AND CARING FOR YOUR REFRIGERATOR

Humidity Control System

IMPORTANT!

When cleaning the shelf above the vegetable bins, we recommend that you do not disassemble the Humidity Control System from the shelf.

In the event that the humidity control lid (plastic lid) and humidity slides become separated from the glass shelf, follow these instructions to reassemble.

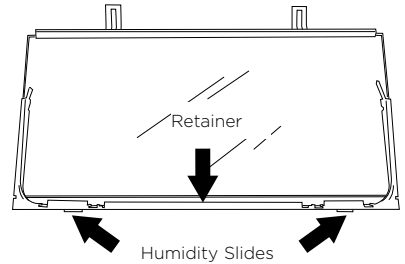

- ① Turn shelf upside down.
- ② To attach humidity slides onto shelf front corners, fit bottom clips into shelf front trim. Next, slide sideways towards shelf until arm clips onto glass.

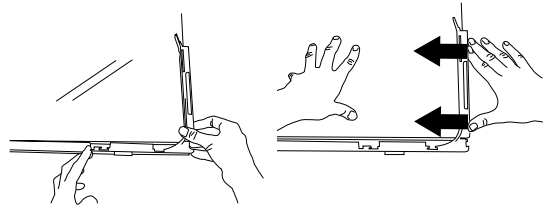

- ③ To attach humidity control lid—with text facing you, align lid with front of shelf. Hold lid vertically and fit front end into retainer on shelf. Ensure lid fits into retainer as well as underneath humidity slides.

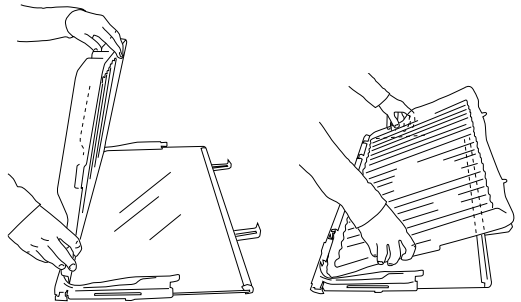

- ④ At the sides of the shelf, adjust humidity slide tabs so that the plastic lid is between the shelf and the tabs.
- ⑤ If clips on back of shelf are present, fasten lid with rear clips. Ensure that the cover is fully secure at front and back of shelf.

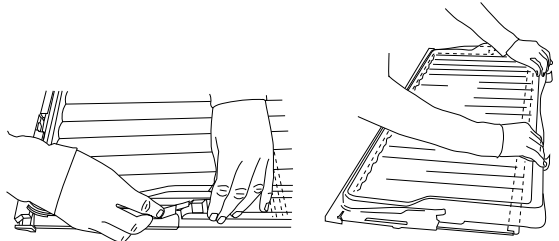

Humidity Control System cleaning

CLEANING AND CARING FOR YOUR REFRIGERATOR

To remove trays or fixed bins

- For ease of removal, empty food from tray/bin first.
- Hold the center front of the tray/bin handle.
- Lift vertically to unclip from the runners and pull tray/bin towards you to remove.
- Push both runners back into refrigerator.

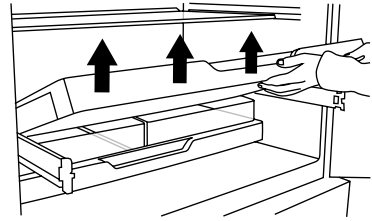

Tray removal

To replace trays or fixed bins

With the runners pushed back into the refrigerator, place the tray/bin on top of the runners. Push the tray/bin back slowly until you feel it clip back onto the runners.

IMPORTANT!

- **Ensure that trays and bins are securely clipped onto the runners before use.**
- **Bin and tray runners are pre-lubricated, and will not need to be re-lubricated during their life. Do not attempt to clean grease from the runners, as this will affect their ability to function. Do not immerse runners in water.**

Permanently fixed bins and trays (Freezer drawer models only)

The freezer bins and trays in this model are permanently fixed. They cannot be removed from the freezer compartment. To clean simply wipe with a soft, damp cloth.

On vacation/holiday

- Turn the ice maker to OFF on the internal control panel.
- Shut off the water supply to the refrigerator.
- On your return, turn on the water supply to the refrigerator.
- Dispense 4qt (4L) of water and discard to ensure the water tank is refilled with fresh water.
- Turn on the ice maker.
- Discard the first 3 harvests of ice (8 ice cubes are produced per harvest).

STORING FOOD IN YOUR REFRIGERATOR

Your refrigerator helps to extend the storage times of fresh perishable foods. The cold temperature slows down the major causes of food spoilage—namely, the growth of bacteria, moulds and yeasts, and any chemical and physical reactions.

Fresh food care

The quality of food before it is placed in the refrigerator is critical to successful storage.

For best results:

- Select foods that are very fresh and of high quality.
- Buy only the amount that you will use within the recommended storage time. If you buy extra, plan to freeze it.
- Ensure that food is well wrapped or covered before it is stored. This will prevent food from dehydrating, deteriorating in color or losing flavor and will help maintain freshness. It will also prevent odor transfer. Fruit and vegetables need not be wrapped provided they are stored in the vegetable bins of the refrigerator.
- Make sure that strong smelling foods are wrapped or covered and stored away from foods such as butter, milk and cream which can be easily tainted by strong odors.
- Refrigerate fresh, perishable foods as soon as possible after purchase. If left at room temperature for any length of time the rate of deterioration will be accelerated.
- Avoid placing food directly in front of air outlets, as it may freeze and cold air needs to circulate to maintain safe food storage.
- Do not open the refrigerator door unnecessarily.
- Cool hot foods down before placing them in the refrigerator. This should be done quickly. It can be aided by placing the container of food in a bowl of ice and water; renew the ice as necessary. (Note also that hot containers may damage shelves and walls of the refrigerator).
- Store raw and cooked food in separate containers or packaging to prevent cross contamination.

In addition:

- Keep the refrigerator clean. Wipe the inside walls and shelves frequently (refer to section 'Cleaning and caring for your refrigerator') and place only clean containers in the refrigerator.
- Keep a close check on the quality of food in your refrigerator. Discard any food that shows signs of spoilage. Pay particular attention to meat, fish and poultry, as these foods are highly perishable. Use food within the recommended storage times.

Dairy foods and eggs

- Most pre-packed dairy foods have a recommended 'use by/best before/best by' date stamped on them. Store them in the refrigerator and use within the recommended time.
- Butter can become easily tainted by strong smelling foods so it is best stored in a sealed container.
- Eggs should be stored in the refrigerator. For best results, especially when baking, remove the eggs from the refrigerator two hours before they are to be used.

STORING FOOD IN YOUR REFRIGERATOR

Red meat

- Place fresh red meat on a plate and loosely cover with waxed paper, plastic wrap or foil.
- Store cooked and raw meat on separate plates. This will prevent any juices lost from the raw meat contaminating the cooked product.
- Delicatessen meats should be used within the recommended storage time.

Poultry

- Fresh whole birds should be rinsed inside and out with cold running water. Dry and place on a plate. Cover loosely with plastic wrap or foil.
- Poultry pieces should also be stored this way. Whole poultry should never be stuffed until just before cooking, otherwise food poisoning may result.
- Cool and refrigerate cooked poultry quickly. Remove stuffing from poultry and store separately.

Fish and seafood

- Whole fish and fillets should be used on the day of purchase. Until required, refrigerate on a plate loosely covered with plastic wrap, waxed paper or foil.
- If storing overnight or longer, take particular care to select very fresh fish. Whole fish should be rinsed in cold water to remove loose scales and dirt and then patted dry with paper towels. Place whole fish or fillets in a sealed plastic bag.
- Keep shellfish chilled at all times. Use within 1 - 2 days.

Precooked foods and leftovers

- These should be stored in suitable covered containers so that the food will not dry out.
- Keep for only 1 - 2 days.
- Reheat leftovers only once and until steaming hot.

Fruit and vegetable bins

- Although most fruit and vegetables keep best at low temperatures, take care not to store the following at temperatures of less than 44.6°F (7°C) for long periods: Citrus fruit, tropical fruit, tomatoes, cucumbers.
- Undesirable changes will occur at low temperatures such as softening of the flesh, browning, accelerated decaying and/or loss of flavor.
- Do not refrigerate avocados (until they are ripe), bananas, mangoes or pepinos.
- If possible store fruit and vegetables separately, ie fruit in one bin and vegetables in the other.
- Each fruit and vegetable bin has a humidity control slide that can be adjusted depending on what is stored in the bins. For more information on using the Humidity Control refer to section 'ActiveSmart™ special features'.

STORING FOOD IN YOUR FREEZER

The use of temperatures of -0.4°F (-18°C) or colder to store food means that the food can be kept for longer periods than when refrigeration temperatures are used. This is because the growth of bacteria, moulds and yeasts are stopped, and chemical and physical reactions are severely restricted at such low temperatures.

Frozen food care

For best results:

- Choose only high quality foods that freeze well.
- Store at -0.4°F (-18°C) or colder. Take care to maintain this low storage temperature, eg try to avoid opening the freezer door unnecessarily. If your ice cream is soft you are running your freezer too warm.
- Leave space at the top of containers, glass jars or plastic bags containing liquids or semi-solid foods. These expand as they freeze. Usually 1 – 2” (20 – 50mm) head space is recommended. Seal. Ideally, remove all the air from the package after food is frozen.
- Packages or containers of solid foods should have the air removed from them and be sealed tightly before freezing.
- Use the 'Fast Freeze' function when freezing fresh food. This helps to speed up the freezing process, giving optimum freezing results. It is recommended that the function is activated approximately 2 hours before required.
- Freeze immediately or as quickly as possible. Freeze only small quantities of food at any one time. For best results we recommend that only 2.2lb (1kg) of food be frozen per 6.6gal (25L) or 0.88 cubic feet of freezer storage volume at any one time. (About 6.6lb (3kg) in small freezers and 8.8lb (4kg) in larger freezers). For faster freezing in ActiveSmart™ models, we recommend that fresh food is placed at the top of the freezer compartment close to the air vent.
- Thaw foods preferably in a refrigerator, or using a microwave oven or multifunction oven.
- Keep a constant turnover of food. Use older items of food first and do not exceed recommended storage times.
- Use good quality freezer proof packaging to maintain food quality.
- If food is only covered in plastic film place inside a freezer-proof plastic bag.

Recommended freezer storage times

These times should not be exceeded.

MONTHS	TYPE OF FOOD STORED
1	Bacon, casseroles, milk
2	Bread, ice cream, sausages, pies – (meat and fruit), prepared shellfish, oily fish
3	Non-oily fish, shellfish, pizza, scones and muffins
4	Ham, cakes, biscuits, beef and lamb chops, poultry pieces
6	Butter, vegetables (blanched), eggs whole and yolks, cooked crayfish, minced meat (raw), pork (raw)
12	Fruit (dry or in syrup), egg whites, beef (raw), whole chicken, lamb (raw), fruit cakes

STORING FOOD IN YOUR FREEZER

Meat, poultry and game

- Do not try to freeze more than 2.2lb (1kg) of meat per 25qt (25L) of freezer storage volume at any one time. Meat must be frozen quickly in order to maintain its texture.
- Do not stuff poultry before freezing.
- Red meat can be cooked from frozen, or from the partly or completely thawed states. Remember to allow extra cooking time if cooking from frozen.
- Always thaw poultry completely before cooking.

Fish

- Fish is best frozen commercially. If, however, you do want to freeze fish at home, make sure the fish is very fresh and of high quality.
- Clean, scale and preferably leave whole. All fish should be wrapped in two layers of packaging as depending on the type of fish, odors and flavors can be readily transferred either to or from it. Seal well.
- For best results, cook from either the frozen or partly thawed state.

Fruit

- Choose high quality, mature, and ready to eat fruit. Preferably select varieties recommended for freezing.
- Avoid unripe and over-ripe fruit.
- The way fruit is packed depends on how it is to be used. Fruits packed in syrup are ideal for desserts, whereas fruits packed without sugar are better used for cooking. Most fruits can be stored for 8 - 12 months.

Vegetables

- Most vegetables freeze well, although 'salad' vegetables lose their crispness. Other vegetables, eg celery, onion and tomatoes, should only be used in cooked dishes as they soften on freezing.
- Freeze only high quality, mature, ready-to-eat vegetables.
- Sort and discard any vegetables that are damaged.
- It is necessary to blanch most raw vegetables prior to freezing.
- Blanching involves a short cooking period during which vegetable enzymes are destroyed. If these enzymes are not destroyed they cause undesirable physical and chemical changes during freezer storage.
- Vegetables can be blanched in boiling water, steam or microwave oven. If using boiling water, boil vegetables for 2 - 4 minutes and cool quickly.
- In general, frozen vegetables are best cooked from their frozen state.

Prepared and cooked foods

- Most cooked foods can be frozen but it is not recommended to freeze the following: Cooked egg white, custards, cream fillings and milk puddings, gelatine or jelly-like dishes, mayonnaise and similar salad dressings, meringue toppings. These tend to separate on thawing.

User warnings

Faults

In the unlikely event a fault occurs the  icon will illuminate on the internal control panel and an alarm will sound when the fresh food compartment door is opened.

- Count the number of beeps made when the fresh food compartment door is opened. Please also take note of the number and sequence of temperature lights displayed on the internal control panel and contact our Customer Care Center.
- To silence the fault alarm press any button on the internal control panel. The  icon will remain illuminated until the fault is corrected.

Normal refrigerator sounds

ActiveSmart™ refrigerators, with their excellent energy ratings and cooling performance, can produce sounds somewhat different to your old refrigerator.

Normal operational sounds include:



- Fan air flow sound. ActiveSmart™ refrigerators have fans which change speed depending on demand. During cooling periods, such as after frequent door openings, fans circulate the cold air in the refrigerator and freezer compartments producing some air flow sound. This is quite normal.
- Cracking or popping which may occur when the defrost function is operating.
- Running water sound. This is the liquid refrigerant in the system and can be heard as a boiling or gurgling noise.
- An audible hissing sound after closing the freezer door. This is due to the pressure difference between the warm air that has entered the cabinet and suddenly cooled, and the outside air pressure.
- Other sounds may be heard for the following reasons:
 - Cabinet not level.
 - Floor uneven or weak.
 - Bottles or jars rattling on shelves.
- If this is your first refrigerator with an ice maker, you will hear occasional sounds that may be unfamiliar. They are normal ice making sounds and are not cause for concern.
- The following sounds are normal with the operation of an ice maker:
 - Motor operation (low humming).
 - Running water as the ice maker and/or water tank fills.
 - Water valve opening and closing (hissing sound).
 - Ice being loosened from the ice moulding tray (cracking).
 - Ice dropping into bin (clunking).

TROUBLESHOOTING

If there is a problem with your appliance, please check the following points before contacting your local Fisher & Paykel trained and supported service technician or the Customer Care Center.

Product parts and accessories can be purchased through Fisher & Paykel Customer Care Center or online at fisherpaykel.com (this service is available to selected markets only).

All models

PROBLEM	POSSIBLE CAUSES	WHAT TO DO
Appliance does not operate.	No electricity at power outlet.	Check that the plug is correctly connected and power switched on.
		Check another appliance at the same outlet.
		Check house fuse.
Light not working.	Light not functioning.	The LED light cannot be serviced by the user. Contact your Fisher & Paykel Dealer or Fisher & Paykel trained and supported service technician.
	Refrigerator not working.	Check refrigerator is turned on at wall.
Light and display not working.	Product in 'Sabbath Mode'.	Press and hold  ,  and  together for 4 seconds.
Motor operates for long periods.	Hot weather.	Minimize door openings to allow temperature to stabilize.
	Frequent door openings.	
	Large amount of food recently added.	
	Temperature control set too low.	Refer to section 'Temperature control'.
	Doors not sealing properly.	Check that cabinet is level and gasket seals are clean.
Storage compartments too warm.	Temperature setting not correct.	Refer to section 'Temperature control'.
	Frequent door openings.	Minimize door openings to allow temperature to stabilize.
	Large amount of food recently added.	
Food freezing in the refrigerator.	Temperature setting not correct.	Refer to section 'Temperature control'.
	Food placed directly in front of air outlets.	Move chill sensitive foods away from the center back of the shelves.

TROUBLESHOOTING

All models

PROBLEM	POSSIBLE CAUSES	WHAT TO DO
Unfamiliar noises.	Cabinet not stable or level. Freezer is defrosting.	Refer to sections 'Installation instructions' or 'ActiveSmart™ user warnings and sounds' .
Water in the vegetable bins.	Condensation is formed by the water produced by fruit and vegetables.	A small amount of condensation is beneficial for fruit and vegetable storage. Wipe out water with a cloth. Set humidity slide to low humidity setting 
Exterior of cabinet is warm.	This is normal.	
Warm spot on central door seal. (French door models only).	You may feel a warm spot at times on the central seal between the two refrigerator doors.	This is perfectly normal and is part of the normal refrigerator operation.
Condensation on outside of refrigerator/freezer.	Not unusual during periods of high humidity.	Wipe dry.
Condensation inside fresh food compartment.	Frequent or long door openings.	Minimize door openings.
	Door gasket leaking.	Check that gasket is sitting flat and sealing tightly.
	Not unusual during periods of high humidity.	Wipe dry.
	Door handles out of alignment.	With time and usage, movement may occur.
Tray/bin does not slide in and out evenly.	Packaging trapped.	Check to ensure no food or packaging is trapped behind the tray/bin.
	Runners not extending fully.	Holding onto sides of tray/bin, extend the runners fully by using a firm pull—this will reset the runner.
Appliance operating inefficiently.	Accumulation of dust on or behind the rear compartment cover.	Refer to section 'Cleaning and caring for your refrigerator'. If problem persists please contact Customer Care.

TROUBLESHOOTING

Ice & Water and Automatic Ice models only

PROBLEM	POSSIBLE CAUSES	WHAT TO DO
Automatic ice maker does not work.	Ice maker has not been turned on.	Switch on ice maker.
	Bin is in the wrong way or there is no bin in place.	Place bin so scoop is on the right side. Ice bin sits directly under ice maker on top left side of freezer.
	Water supply turned off or not connected.	Connect water supply.
	Freezer compartment not working.	Contact Customer Care.
	Water pressure too low.	Check water pressure.
	Water line kinked/squashed.	Check water line for kinks/squashing.
	Filter clogged.	Water filter may need replacing.
Ice cubes have odor/taste.	Unsealed packages may be transmitting odor/taste.	Old cubes need to be discarded. Ensure food packaging is sealed.
	Interior of freezer needs cleaning.	Ice storage bin needs to be emptied and washed. Clean refrigerator.
	Poor taste from incoming water.	Filter may need changing. A new filter may need to be installed. Force 2 - 3 ice tray flips.
Slow ice cube freezing.	Door may have been left ajar.	Close door.
	Freezer compartment too warm.	Turn temperature to a colder setting.
Taste of odor in ice cubes.	Transfer of odor/taste from strong smelling foods.	Wrap or cover strong smelling foods.

TROUBLESHOOTING

Ice & Water and Automatic Ice models only

PROBLEM	POSSIBLE CAUSES	WHAT TO DO
Wet ice/ ice clumping.	Low water pressure.	Check water pressure.
	Filter blocked.	Replace filter.
	Long freezer door openings.	Gently tap ice with scoop to unstick or, if large clumps occur, empty ice bin and make new ice.
	High ambient temperature.	
	Ice bin left out of freezer compartment for a length of time. Ice will stick together over time.	
Filter warning light  is flashing.	Filter needs replacing.	Replace filter as soon as possible.
Ice buildup inside freezer compartment.	Freezer door not closing tightly.	Arrange items in freezer so door can close tightly.
		Check and clean door gasket seal.
Ice maker makes unfamiliar sounds or seems too loud.	Normal ice maker operation.	Refer to section 'ActiveSmart™ user warnings and sounds'.
Ice boost function not increasing rate of ice production.	Ambient temperature very warm.	Minimize door openings.
	Refrigerator is in high usage.	

TROUBLESHOOTING

Ice & Water models only

PROBLEM	POSSIBLE CAUSES	WHAT TO DO
Water has poor taste/odor.	Refrigerator not used for an extended period.	Dispense 4qt (4L) of water so fresh water supply is replenished.
Water dispenser does not work.	Water supply turned off or not connected.	Turn water on. Press dispenser for 2 minutes to remove trapped air from water line and to fill the water system.
	Supply line may be blocked.	Check supply for kinks or leaks.
	On first installation there may be air in water system.	To remove air, run 3qt (3L) of water through the dispenser.
	Filter may be blocked and need replacing.	Replace filter. (Replacement filter cartridges can be purchased online from fisherpaykel.com or by calling Fisher & Paykel Customer Care).
	'Dispenser Lock' activated.	Press and hold the  button for 4 seconds.
	Water frozen in tank.	Increase temperature to a warmer setting in fresh food compartment and freezer.
Water in first glass is warm.	Water dispenser not used for extended period.	Discard first glass of water dispensed.
	Tank capacity used recently.	Allow water time to cool.
Drips overflow drip-shelf.	Air trapped in tank.	Flush 3qt (3L) water through dispenser, stopping intermittently.
	New filter installed.	Flush 4qt (4L) water through filter and then 3qt (3L) through dispenser.
Water flow rate has slowed down.	Filter cartridge is restricted.	Replace filter as soon as possible.

SERVICE AND WARRANTY

For details of your manufacturer's warranty and contacts for servicing, please refer to your separate 'Service & Warranty' book provided with your refrigerator.

Complete and keep for safe reference:

Model _____

Serial No. _____

Purchase Date _____

Purchaser _____

Dealer _____

City _____

State _____

Zip _____

Country _____

FISHERPAYKEL.COM

© Fisher & Paykel Appliances 2018. All rights reserved.

The product specifications in this booklet apply to the specific products and models described at the date of issue. Under our policy of continuous product improvement, these specifications may change at any time. You should therefore check with your Dealer to ensure this booklet correctly describes the product currently available.

US CA

847798B 07.18