

SONY

Digital Still Camera DSC-RX1RM2

How to Use

Before Use

Names of parts

- [Checking the camera and the supplied items \[1\]](#)
- [Identifying parts \(Front side\) \[2\]](#)
- [Identifying parts \(Rear side\) \[3\]](#)
- [Identifying parts \(Top side/Side view\) \[4\]](#)
- [Identifying parts \(Bottom view\) \[5\]](#)

Icons and indicators

- [List of icons on the screen \[6\]](#)
- [List of focus range finder frames \[7\]](#)

Using the strap

- [Using the shoulder strap \[8\]](#)

Attaching the eyepiece cup

- [Attaching the eyepiece cup \[9\]](#)

Adjusting the viewfinder

- [Adjusting the viewfinder \(diopter-adjustment\) \[10\]](#)

In-Camera guide

- [About the \[In-Camera Guide\] \[11\]](#)

Preparing the camera

Charging the battery pack

- [Charging the battery pack using a charger \[12\]](#)
- [Inserting the battery pack into the camera \[13\]](#)
- [Charging the battery pack while it is inserted in the camera \[14\]](#)
- [Charging by connecting to a computer \[15\]](#)
- [Battery life and the number of images that can be recorded/played back using a battery pack \[16\]](#)
- [Supplying power from a wall outlet \(wall socket\) \[17\]](#)
- [Removing the battery pack \[18\]](#)

Inserting a memory card (sold separately)

- [Inserting a memory card \[19\]](#)
- [Removing the memory card \[20\]](#)
- [Usable memory cards \[21\]](#)

Setting the language, date and time

- [Setting language, date and time \[22\]](#)

Confirming the operation method

Confirming the operation method

- [Using the control wheel \[23\]](#)
- [Using the control dial \[24\]](#)
- [Using MENU items \[25\]](#)
- [Using the Fn \(Function\) button \[26\]](#)
- [Using the "Quick Navi" \[27\]](#)

Shooting

Shooting still images/movies

- [Shooting still images \[28\]](#)
- [Shooting movies \[29\]](#)

Selecting a shooting mode

- [List of mode dial functions \[30\]](#)
- [Intelligent Auto \[31\]](#)
- [Superior Auto \[32\]](#)
- [About Scene Recognition \[33\]](#)
- [The advantages of automatic shooting \[34\]](#)
- [Program Auto \[35\]](#)
- [Sweep Panorama \[36\]](#)
- [Scene Selection \[37\]](#)
- [Shutter Priority \[38\]](#)
- [Aperture Priority \[39\]](#)
- [Manual Exposure \[40\]](#)
- [BULB \[41\]](#)
- [Memory recall \[42\]](#)
- [Movie \[43\]](#)

Using shooting functions

Using the zoom

- [Zoom \[44\]](#)
- [The zoom features available with this product \[45\]](#)
- [Zoom Setting \[46\]](#)
- [About zoom scale \[47\]](#)
- [Smart Telecon. \[48\]](#)

Using the flash

- [Using flash \(sold separately\) \[49\]](#)
- [Notes on using the flash \[50\]](#)
- [Flash Mode \[51\]](#)
- [Flash Comp. \[52\]](#)

Selecting a screen display mode

- [Switching the screen display \(Shooting\) \[53\]](#)
- [Switching between the viewfinder and the screen \[54\]](#)
- [DISP Button \(Finder\) \[55\]](#)
- [DISP Button \(Monitor\) \[56\]](#)

Selecting still image size/image quality

- [Image Size \(still image\) \[57\]](#)
- [Aspect Ratio \(still image\) \[58\]](#)
- [Quality \(still image\) \[59\]](#)
- [RAW File Type \(still image\) \[60\]](#)
- [Panorama: Size \[61\]](#)
- [Panorama: Direction \[62\]](#)

Adjusting the focus

- [Changing the focus method using the focus mode dial \[63\]](#)
- [Focus Area \[64\]](#)
- [Phase detection AF \[65\]](#)
- [Center Lock-on AF \[66\]](#)
- [Focus-lock \[67\]](#)
- [Manual Focus \[68\]](#)
- [Direct manual focus \(DMF\) \[69\]](#)
- [MF Assist \(still image\) \[70\]](#)
- [Focus Magnifier \[71\]](#)
- [Focus Magnif. Time \[72\]](#)
- [Peaking Level \[73\]](#)
- [Peaking Color \[74\]](#)

- [Pre-AF \(still image\) \[75\]](#)
- [AF/MF control \[76\]](#)
- [AF Illuminator \(still image\) \[77\]](#)
- [Disp. cont. AF area \[78\]](#)
- [Eye AF \[79\]](#)
- [Phase Detect. Area \[80\]](#)
- [Measuring the exact distance to the subject \[81\]](#)
- [Priority Set in AF-S \[82\]](#)
- [Priority Set in AF-C \[83\]](#)

Adjusting the exposure

- [Exposure Comp. \[84\]](#)
- [Exposure compensation dial \[85\]](#)
- [Metering Mode \[86\]](#)
- [AE lock \[87\]](#)
- [AEL w/ shutter \(still image\) \[88\]](#)
- [Exp.comp.set \[89\]](#)
- [Zebra \[90\]](#)
- [Exposure Set. Guide \[91\]](#)
- [Reset EV Comp. \[92\]](#)

Selecting a drive mode (Continuous shooting/Self-timer)

- [Drive Mode \[93\]](#)
- [Cont. Shooting \[94\]](#)
- [Spd Priority Cont. \[95\]](#)
- [Self-timer \[96\]](#)
- [Self-timer\(Cont\) \[97\]](#)
- [Cont. Bracket \[98\]](#)
- [Single Bracket \[99\]](#)
- [WB bracket \[100\]](#)
- [DRO Bracket \[101\]](#)
- [LPF Bracket \[102\]](#)

- [Settings for bracket shooting \[103\]](#)
- [Indicator during bracket shooting \[104\]](#)

Selecting the ISO sensitivity

- [ISO \[105\]](#)
- [ISO AUTO Min. SS \[106\]](#)
- [Multi Frame NR \[107\]](#)

Correcting the brightness or contrast

- [D-Range Opt. \(DRO\) \[108\]](#)
- [Auto HDR \[109\]](#)

Adjusting color tones

- [White Balance \[110\]](#)
- [Capturing a basic white color in \[Custom Setup\] mode \[111\]](#)

Selecting an effect mode

- [Picture Effect \[112\]](#)
- [Creative Style \[113\]](#)

Recording movies

- [Movie recording formats \[114\]](#)
- [File Format \(movie\) \[115\]](#)
- [Record Setting \(movie\) \[116\]](#)
- [Dual Video REC \[117\]](#)
- [Marker Display \(movie\) \[118\]](#)
- [Marker Settings \(movie\) \[119\]](#)
- [SteadyShot \(movie\) \[120\]](#)
- [Audio Recording \[121\]](#)
- [Audio Level Display \[122\]](#)
- [Audio Rec Level \[123\]](#)
- [Wind Noise Reduct. \[124\]](#)

- [Auto Slow Shut. \(movie\) \[125\]](#)
- [MOVIE Button \[126\]](#)

Customizing the shooting functions for convenient use

- [Memory \[127\]](#)
- [Function Menu Set. \[128\]](#)
- [Custom Key\(Shoot.\) / Custom Key\(PB\) \[129\]](#)
- [Function of the control wheel \[130\]](#)
- [Function of the AEL button \[131\]](#)
- [Function of the Custom button \[132\]](#)
- [Function of the Center button \[133\]](#)
- [Function of the Left button \[134\]](#)
- [Function of the Right button \[135\]](#)
- [Function of the down button \[136\]](#)

Setting the other functions of this product

- [Smile/Face Detect. \[137\]](#)
- [Soft Skin Effect \(still image\) \[138\]](#)
- [Face Registration \(New Registration\) \[139\]](#)
- [Face Registration \(Order Exchanging\) \[140\]](#)
- [Face Registration \(Delete\) \[141\]](#)
- [Red Eye Reduction \[142\]](#)
- [Auto Obj. Framing \(still image\) \[143\]](#)
- [Long Exposure NR \(still image\) \[144\]](#)
- [High ISO NR \(still image\) \[145\]](#)
- [Write Date \(still image\) \[146\]](#)
- [Color Space \(still image\) \[147\]](#)
- [Grid Line \[148\]](#)
- [Auto Review \[149\]](#)
- [Live View Display \[150\]](#)
- [Bright Monitoring \[151\]](#)
- [FINDER/MONITOR \[152\]](#)

- [Release w/o Card \[153\]](#)
- [Shading Comp. \[154\]](#)
- [Chro. Aber. Comp. \[155\]](#)
- [Distortion Comp. \[156\]](#)
- [Dial / Wheel Lock \[157\]](#)
- [Deactivate Monitor \[158\]](#)
- [LPF Effect \[159\]](#)

Viewing

Viewing still images

- [Playing back images \[160\]](#)
- [Playback zoom \[161\]](#)
- [Image Index \[162\]](#)
- [Switching the screen display \(during playback\) \[163\]](#)

Deleting images

- [Deleting a displayed image \[164\]](#)
- [Deleting multiple selected images \[165\]](#)

Playing back movies

- [Playing back movies \[166\]](#)

Viewing panoramic images

- [Playing back panoramic images \[167\]](#)

Printing

- [Specify Printing \[168\]](#)

Using viewing functions

- [View Mode \[169\]](#)

[Display Rotation \[170\]](#)

- [Slide Show \[171\]](#)
- [Rotate \[172\]](#)
- [Protect \[173\]](#)
- [4K Still Image PB \[174\]](#)

Viewing images on a TV

- [Viewing images on an HD TV \[175\]](#)
- [Viewing images on a “BRAVIA” Sync-compatible TV \[176\]](#)

Changing settings

Setup menu

- [Monitor Brightness \[177\]](#)
- [Viewfinder Bright. \[178\]](#)
- [Finder Color Temp. \[179\]](#)
- [Volume Settings \[180\]](#)
- [Audio signals \[181\]](#)
- [Upload Settings\(Eye-Fi\) \[182\]](#)
- [Tile Menu \[183\]](#)
- [Mode Dial Guide \[184\]](#)
- [Delete confirm. \[185\]](#)
- [Display Quality \[186\]](#)
- [Pwr Save Start Time \[187\]](#)
- [NTSC/PAL Selector \[188\]](#)
- [Demo Mode \[189\]](#)
- [HDMI Resolution \[190\]](#)
- [24p/60p Output \(movie\) \(Only for 1080 60i compatible models\) \[191\]](#)
- [CTRL FOR HDMI \[192\]](#)
- [HDMI Info. Display \[193\]](#)
- [USB Connection \[194\]](#)
- [USB LUN Setting \[195\]](#)

- [USB Power Supply \[196\]](#)
- [Language \[197\]](#)
- [Date/Time Setup \[198\]](#)
- [Area Setting \[199\]](#)
- [Copyright Info \[200\]](#)
- [Format \[201\]](#)
- [File Number \[202\]](#)
- [Select REC Folder \[203\]](#)
- [New Folder \[204\]](#)
- [Folder Name \[205\]](#)
- [Recover Image DB \[206\]](#)
- [Display Media Info. \[207\]](#)
- [Version \[208\]](#)
- [Certification Logo \(For some models only\) \[209\]](#)
- [Setting Reset \[210\]](#)

Using Wi-Fi functions

Connecting this product and a Smartphone

- [PlayMemories Mobile \[211\]](#)
- [Connecting an Android smartphone to this product \[212\]](#)
- [Connecting the product to an iPhone or iPad \[213\]](#)
- [Calling up an application using \[One-touch\(NFC\)\] \[214\]](#)

Controlling this product using a Smartphone

- [Smart Remote Embedded \[215\]](#)
- [One-touch connection with an NFC-enabled Android smartphone \(NFC One-touch remote\) \[216\]](#)

Transferring images to a Smartphone

- [Send to Smartphone \[217\]](#)
- [Sending images to an Android smartphone \(NFC One-touch Sharing\) \[218\]](#)

Transferring images to a computer

- [Send to Computer \[219\]](#)

Transferring images to a TV

- [View on TV \[220\]](#)

Changing the settings of Wi-Fi functions

- [Airplane Mode \[221\]](#)
- [WPS Push \[222\]](#)
- [Access Point Set. \[223\]](#)
- [Edit Device Name \[224\]](#)
- [Disp MAC Address \[225\]](#)
- [SSID/PW Reset \[226\]](#)
- [Reset Network Set. \[227\]](#)

Adding applications to the product

PlayMemories Camera Apps

- [PlayMemories Camera Apps \[228\]](#)
- [Recommended computer environment \[229\]](#)

Installing the applications

- [Opening a service account \[230\]](#)
- [Downloading applications \[231\]](#)
- [Downloading applications directly to the product using the Wi-Fi function \[232\]](#)

Starting the applications

- [Launching the downloaded application \[233\]](#)

Managing the applications

- [Uninstalling applications \[234\]](#)

- [Changing the order of applications \[235\]](#)
- [Confirming the account information of PlayMemories Camera Apps \[236\]](#)

Using a computer

Recommended computer environment

- [Recommended computer environment \[237\]](#)

Using the software

- [PlayMemories Home \[238\]](#)
- [Installing PlayMemories Home \[239\]](#)
- [Software for Mac computers \[240\]](#)
- [Image Data Converter \[241\]](#)
- [Installing Image Data Converter \[242\]](#)
- [Accessing Image Data Converter Guide \[243\]](#)
- [Remote Camera Control \[244\]](#)
- [Installing Remote Camera Control \[245\]](#)
- [Accessing the Help of Remote Camera Control \[246\]](#)

Connecting this product and a computer

- [Connecting the product to a computer \[247\]](#)
- [Importing images to the computer \[248\]](#)
- [Disconnecting the product from the computer \[249\]](#)

Creating a movie disc

- [Selecting a disc to be created \[250\]](#)
- [Creating Blu-ray Discs from high-definition image quality movies \[251\]](#)
- [Creating DVD discs \(AVCHD recording discs\) from high-definition image quality movies \[252\]](#)
- [Creating DVD discs from standard image quality movies \[253\]](#)

Precautions/This product

Precautions

- [Precautions \[254\]](#)
- [On the internal rechargeable battery \[255\]](#)
- [Notes on the battery pack \[256\]](#)
- [Charging the battery pack \[257\]](#)
- [Notes on memory card \[258\]](#)

Cleaning this product

- [On cleaning \[259\]](#)

Number of recordable still images and recordable time of movies

- [Number of still images \[260\]](#)
- [Recordable time of movies \[261\]](#)

Using this product abroad

- [Plug adaptor \[262\]](#)
- [On TV color systems \[263\]](#)

Other information

- [ZEISS lens \[264\]](#)
- [AVCHD format \[265\]](#)
- [License \[266\]](#)

Trademarks

- [Trademarks \[267\]](#)

Troubleshooting

If you have problems

If you have problems

- [Troubleshooting \[268\]](#)

Troubleshooting

Battery pack and power

- [You cannot insert the battery pack into the product. \[269\]](#)
- [You cannot turn on the product. \[270\]](#)
- [The power turns off suddenly. \[271\]](#)
- [The remaining battery level indicator shows an incorrect level. \[272\]](#)
- [The charge lamp on the product/the CHARGE lamp of the battery charger flashes when charging the battery pack. \[273\]](#)
- [The battery pack is not charged. \[274\]](#)
- [The monitor does not turn on even when the product is turned on. \[275\]](#)

Shooting still images/movies

- [You cannot record images. \[276\]](#)
- [Recording takes a long time. \[277\]](#)
- [The same image is captured multiple times. \[278\]](#)
- [The shutter is released continuously. \[279\]](#)
- [The image is out of focus. \[280\]](#)
- [Zoom does not work. \[281\]](#)
- [The flash does not work. \[282\]](#)
- [Fuzzy white circular spots appear on images shot using the flash. \[283\]](#)
- [The close-up shoot function \(Macro\) does not work. \[284\]](#)
- [The recording date and time are not displayed on the screen. \[285\]](#)
- [The date and time are recorded incorrectly. \[286\]](#)
- [The aperture value and/or shutter speed flashes. \[287\]](#)
- [The image colors are not correct. \[288\]](#)

- Noise appears in the image when you view the screen in a dark place. [289]
- The eyes of the subject come out red. [290]
- Dots appear and remain on the screen. [291]
- You cannot shoot images continuously. [292]
- The image is not clear in the viewfinder. [293]
- No images appear on the viewfinder. [294]
- No images appear on the monitor. [295]
- [Finder/Monitor Sel.] does not work even though it has been assigned to a certain key using [Custom Key(Shoot.)] or [Custom Key(PB)]. [296]
- The image is whitish (Flare)./Blurring of light appears on the image (Ghosting). [297]
- The image is blurred. [298]
- The monitor darkens after a short period of time passed. [299]
- The flash takes too long to recharge. [300]
- The control dial or control wheel does not work. [301]
- Sound is not recorded properly. [302]

Viewing images

- Images cannot be played back. [303]
- Displaying images takes a while. [304]
- The date and time are not displayed. [305]
- Images are not displayed on the monitor when using a thumb grip (sold separately). [306]
- The image cannot be deleted. [307]
- The image was deleted by mistake. [308]
- A DPOF mark cannot be put. [309]

Wi-Fi

- You cannot find the wireless access point to be connected. [310]
- [WPS Push] does not work. [311]
- [Send to Computer] is canceled halfway. [312]
- You cannot send movies to a smartphone. [313]
- [Smart Remote Embedded] or [Send to Smartphone] is canceled halfway. [314]
- The shooting screen for [Smart Remote Embedded] is not displayed smoothly./The connection between this product and the smartphone is disconnected. [315]

- You cannot use One-Touch connection (NFC). [316]

Computers

- The computer does not recognize this product. [317]
- You cannot import images. [318]
- The image and sound are interrupted by noise when viewing a movie on a computer. [319]
- Images exported from a computer cannot be viewed on this product. [320]

Memory cards

- Formatted the memory card by mistake. [321]

Printing

- You cannot print images. [322]
- The color of the image is strange. [323]
- Images are printed with both edges cut off. [324]
- You cannot print images with the date. [325]

Others

- The lens gets fogged. [326]
- The product becomes warm when you use it for a long time. [327]
- The Clock Set screen appears when you turn on the product. [328]
- The number of recordable images does not decrease, or decreases two images at a time. [329]
- Settings are reset even though resetting operation has not been performed. [330]
- The product does not work properly. [331]
- "--E-" appears on the screen. [332]

Messages

Messages

- Self-diagnosis display [333]

- [Warning messages \[334\]](#)

Situations this product has difficulty handling

Situations this product has difficulty handling

- [Situations this product has difficulty handling \[335\]](#)

[1] How to Use | Before Use | Names of parts

Checking the camera and the supplied items

The number in parentheses indicates the number of pieces.

- Camera (1)
- AC Adaptor (1)
The shape of the AC Adaptor differs for each country/region.
- Battery charger (1)
- Power cord (mains lead) (1)
(supplied in some countries/regions)

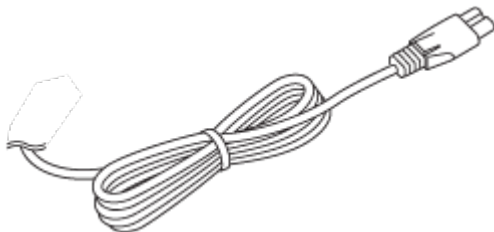

- NP-BX1 Rechargeable battery pack (1)

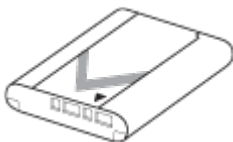

- Micro USB Cable (1)

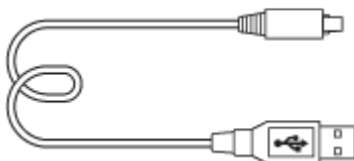

- Shoulder strap (1)

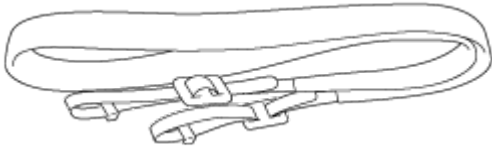

- Lens cap (1)

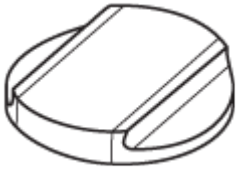

- Shoe cap (1) (Attached on the camera)
- Eyepiece cup (1)



- Cleaning cloth (1)
- Instruction Manual (1)
- Wi-Fi Connection/One-touch (NFC) Guide (1)

[2] How to Use | Before Use | Names of parts

Identifying parts (Front side)

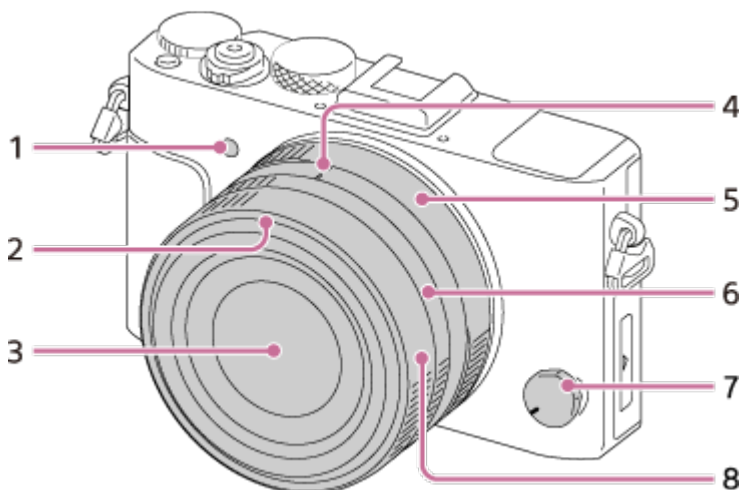



1. AF illuminator/Self-timer lamp
2. Lens hood index
3. Lens
4. Aperture index/Macro switching index
5. Aperture ring

6. Macro switching ring
7. Focus mode dial
8. Focus ring

[3] How to Use | Before Use | Names of parts

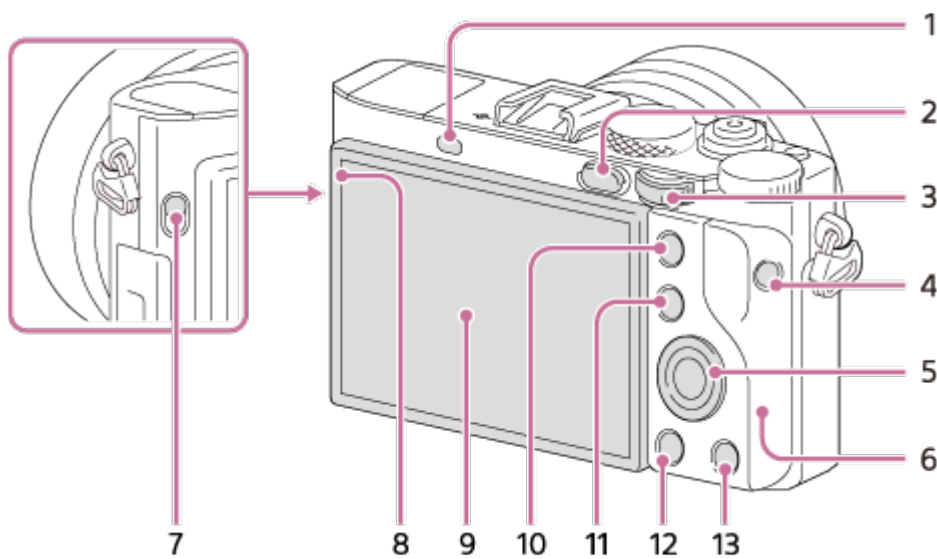
Identifying parts (Rear side)



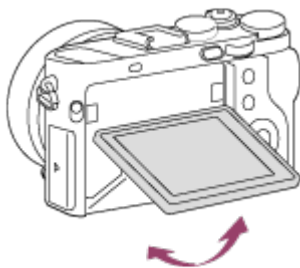

1. Eye sensor
2.  (Playback) button
3. Control dial
4. MOVIE button
5. Control wheel
6. Wi-Fi antenna (built-in)
7. FINDER (Viewfinder pop-up) switch
8. Light sensor
9. Monitor

- You can adjust the monitor to an easily viewable angle and shoot from any position.



- Pull out the bottom of the monitor to open it.
- You may not be able to adjust the monitor angle depending on the type of a tripod you use. In such a case, release the tripod screw once to adjust the monitor angle.

10. For shooting: AEL button
For viewing:  (Enlarge) button
11. For shooting: Fn button
For viewing:  (Image index) button
12. MENU button
13. For shooting: C2 (Custom 2) button
For viewing:  (Delete) button

[4] How to Use | Before Use | Names of parts

Identifying parts (Top side/Side view)

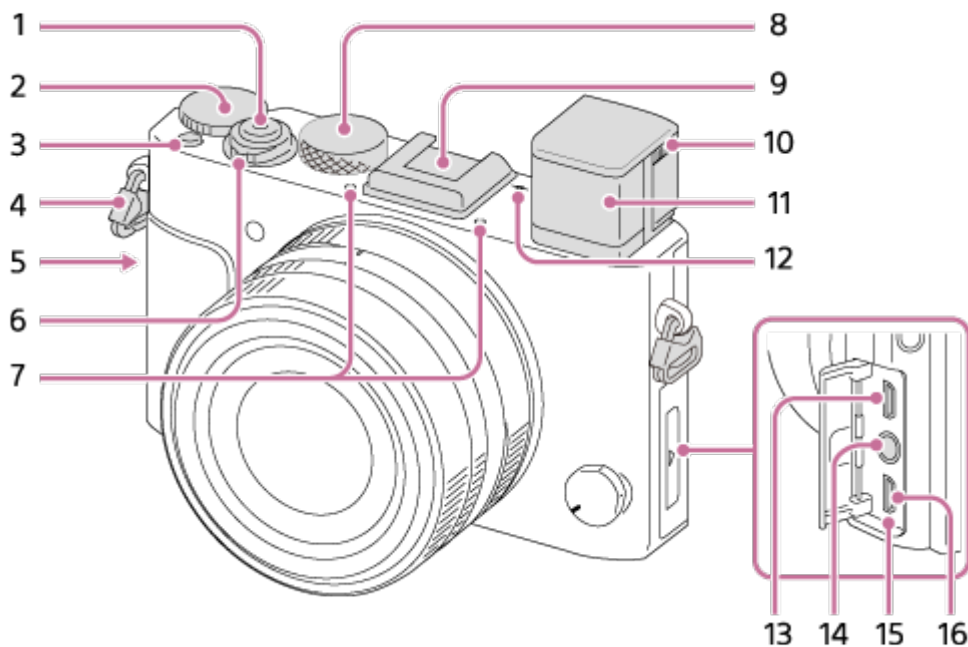

1. Shutter button
2. Exposure compensation dial
3. C1 (Custom 1) button
4. Hooks for shoulder strap
 - Attach both ends of the strap onto the camera.

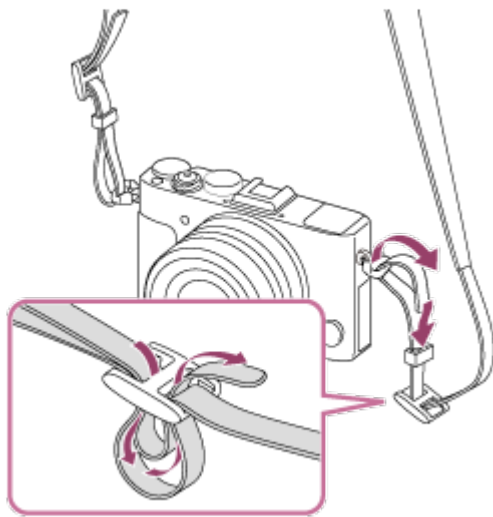

5.  (N mark)

- This mark indicates the touch point for connecting the camera and an NFC-enabled Smartphone.

For details on the location of the  (N mark) on your Smartphone, refer to the operating instructions of the Smartphone.

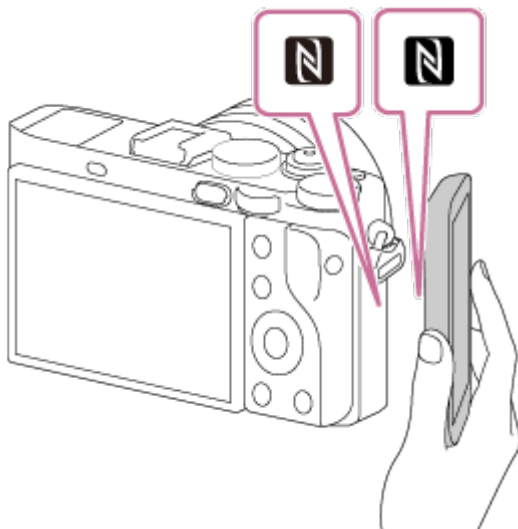

- NFC (Near Field Communication) is an international standard of short-range wireless communication technology.

6. ON/OFF (Power) switch

7. Built-in microphone*¹



8. Mode dial

9. Multi interface shoe*²

- Some accessories may not be attachable with the viewfinder up. In this case, push the viewfinder down.
- Some of the accessories may not be inserted fully and protrude backward from the Multi interface shoe. However, when the accessory reaches the front end of the shoe, the connection is completed.

10. Diopter-adjustment slider

- Adjust the diopter-adjustment slider according to your eyesight until the display appears clearly in the viewfinder.

11. Viewfinder
12.  Image sensor position mark
13. HDMI micro jack
14.  (Microphone) jack*³
 - When an external microphone is connected, the microphone is turned on automatically. If the external microphone is a plug-in-power type, the power of the microphone is supplied by the camera.
15. Charge lamp
16. Multi/Micro USB Terminal*²
 - Supports Micro USB compatible device.

*¹ Do not cover this part while recording movies. Doing so may cause noise or lower the volume.

*² For details on compatible accessories for the multi interface shoe and the Multi/Micro USB Terminal, visit the Sony website, or consult your Sony dealer or local authorized Sony service facility.

You can also use accessories that are compatible with the accessory shoe. Operations with other manufactures' accessories are not guaranteed.

 **Multi
Interface Shoe**

Accessory Shoe

*³ While an external microphone is connected, you cannot connect a cable to the HDMI micro jack or the Multi/Micro USB Terminal.

[5] How to Use | Before Use | Names of parts

Identifying parts (Bottom view)

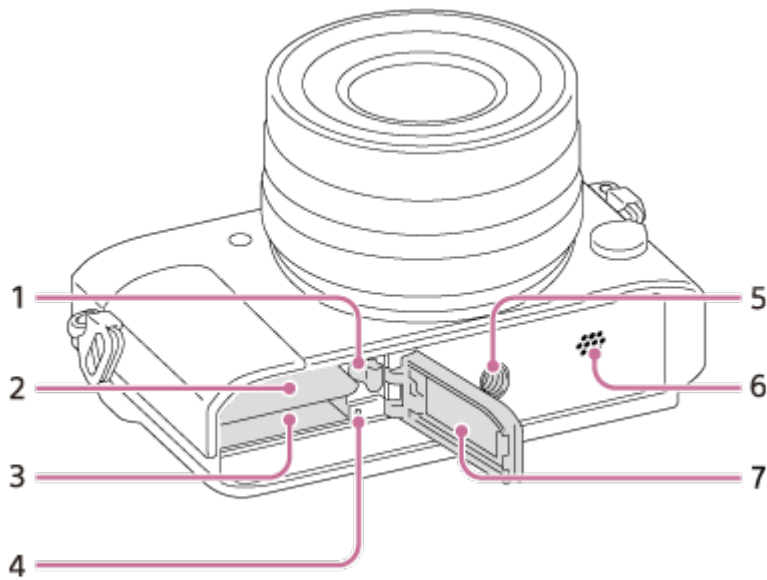

1. Battery lock lever
2. Battery insertion slot
3. Memory card slot
4. Access lamp
5. Tripod socket hole

- Use a tripod with a screw less than 5.5 mm (7/32 inches) long. Otherwise, you cannot firmly secure the camera, and damage to the camera may occur.

6. Speaker
7. Battery/Memory card cover

[6] How to Use | Before Use | Icons and indicators

List of icons on the screen

The displayed contents and their positions shown below are just a guideline, and may differ from the actual display.

Monitor mode

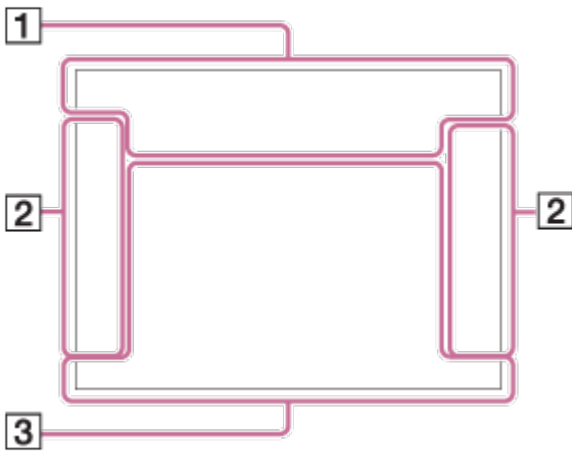

Viewfinder mode

In Auto Mode or Scene Selection mode

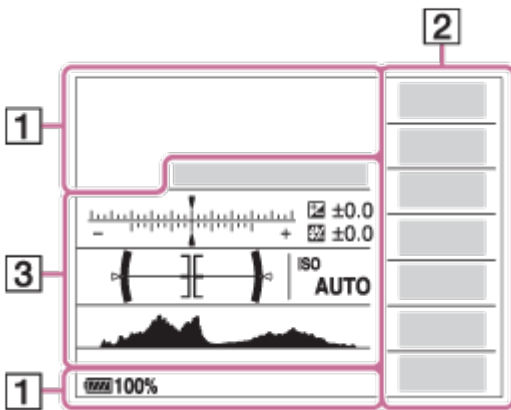

P/A/S/M/Sweep Panorama mode

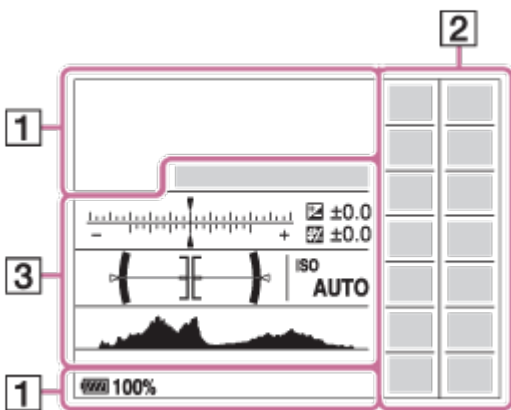

For playback

Basic information display

Frame rate of movies



Record setting of movies



Remaining battery



Remaining battery warning



USB power supply



Flash charge in progress



Setting Effect OFF



AF Illuminator



NFC is activated



Airplane Mode



No audio recording of movies



Wind Noise Reduction



SteadyShot Off/On, Camera shake warning



Overheating warning



Database file full/Database file error



Smart Zoom/ Clear Image Zoom/Digital Zoom



View Mode

100-0003

Folder-file number



Protect

XAVC S HD AVCHD MP4

File format of movies

DPOF

DPOF set



Auto object framing image



Dual Video REC

-PC-

PC Remote



Bright Monitoring



Copyright information writing on

- 2. Drive mode



Flash mode/Red-eye reduction

±0.0

Flash compensation

AF-S AF-C MF DMF

Focus mode



Focus area



Smile/Face Detect.



Metering mode

AWB -1 0 +1 +2 WB 7500K A5 G5

White balance (Auto, Preset, Custom, Color temperature, Color filter)



D-Range Optimizer/Auto HDR

LPF LPF LPF LPF
OFF STD HI II

LPF Effect/Low pass filter effect switching notification

Std.↑ Vivid↑ Ntrl↑ Clear↑ Deep↑ Light↑ Port.↑ Land.↑ Sunset↑ Night↑ Autm.↑ B/W↑ Sepia↑ +3 +3 +3

Creative Style/Contrast, Saturation, Sharpness

Toy Warm Pop Pos Pos Retro SfrH key Part R Part G Part B Part Y HC BW Soft Mid Prtg Mid Rich BW WtrC Illus Mid Mini Auto OFF

Picture Effect



Smile detection sensitivity indicator



Copyright information exists for image

PEAK PEAK PEAK PEAK
HI MID LO OFF

Peaking

3. ● Lock-on AF

Guide display for Lock-on AF

-6 5 4 3 2 1 0 1 2 3 4+

Bracket indicator



Exposure compensation/Metered Manual

STBY

Movie recording standby

REC 0:12

Recording time of the movie (m:s)



Focus

1/250

Shutter speed

F3.5

Aperture Value

ISO400

ISO AUTO

ISO sensitivity



AE lock



Shutter speed indicator



Aperture indicator



Histogram

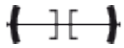

Digital level gauge



Audio level



DRO/Auto HDR/Auto HDR image warning



Picture Effect error

2015-1-1

10:37AM

Date of recording

3/7

File number/Number of images in the view mode



Spot metering area

C:32:00

Self-diagnosis display



Smart Telecon.



Macro mode

The focus range finder frame differs as follows depending on the shooting mode.

When using contrast AF or phase detection AF mode

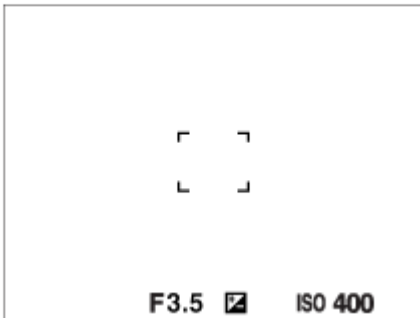

When using phase detection AF mode

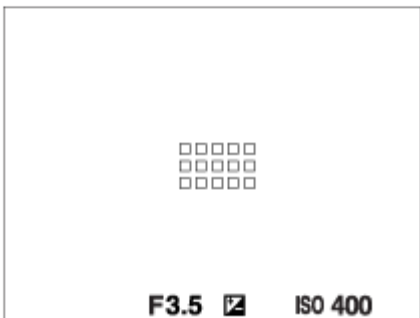

- When [Focus Area] is set to [Wide], and if you aim at a moving subject, the focus range finder frame may be displayed as above.

When focus is achieved automatically based on the whole range of the monitor

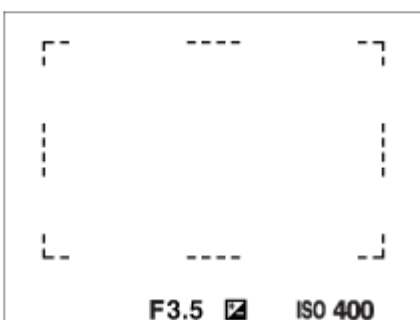

- When you use a zoom function, the [Focus Area] setting is disabled and the focus area

frame is shown by the dotted line. The AF operates with priority on and around the center area.

[8] How to Use | Before Use | Using the strap

Using the shoulder strap

Attach the shoulder strap to prevent damage caused by dropping the product.

1. Attach both ends of the strap.

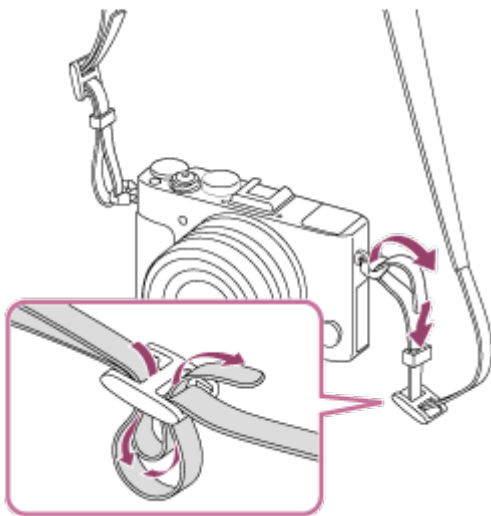

[9] How to Use | Before Use | Attaching the eyepiece cup

Attaching the eyepiece cup

In some situations, such as shooting against the sun, it is recommended that you attach the eyepiece cup when using the viewfinder. Adjust the diopter by sliding the diopter-adjustment slider before attaching the eyepiece cup.

1. Slide down the FINDER (viewfinder pop-up) switch to raise the viewfinder.
2. Make sure that the end of the eyepiece cup screw (**A**) is not sticking out of the frame.

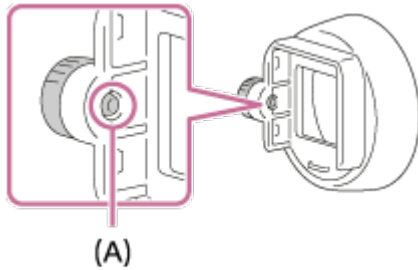

- If the screw is sticking out of the frame, loosen the screw.

3. While holding the eyepiece between your fingers, insert the eyepiece cup into the eyepiece.

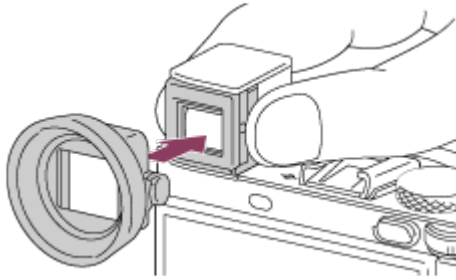

- Insert the eyepiece cup until it pops in.

4. Tighten the screw to lock the eyepiece cup in place.

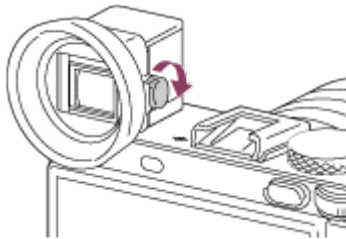

To remove the eyepiece cup

Loosen the eyepiece cup screw and remove the eyepiece cup.

Note

- When the eyepiece cup is attached, the viewfinder cannot be stored.
- Do not push down the viewfinder with the eyepiece cup attached. The camera or the eyepiece cup may be damaged.
- When the eyepiece cup is attached, some accessories cannot be attached.

[10] How to Use | Before Use | Adjusting the viewfinder

Adjusting the viewfinder (diopter-adjustment)

Adjust the diopter scale to your eyesight until the display appears clearly in the viewfinder.

1. Slide the Viewfinder pop-up switch **(A)** down to raise the viewfinder.

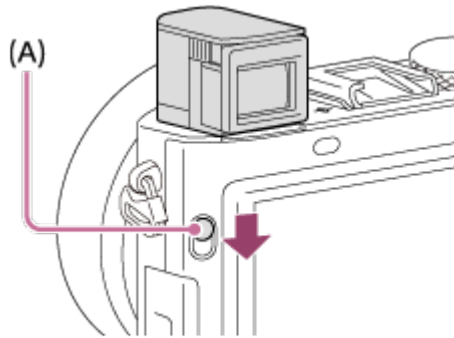

2. Slide the diopter-adjustment slider.

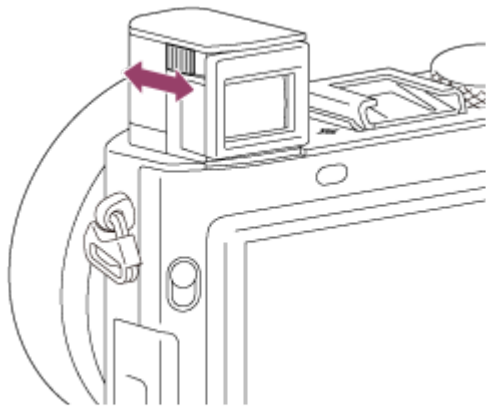

Hint

To store the viewfinder

Push down the viewfinder.

Note

- Be careful not to push down on the viewfinder when it is being raised.
- Do not carry the camera by the viewfinder.

[11] How to Use | Before Use | In-Camera guide

About the [In-Camera Guide]

The [In-Camera Guide] displays descriptions of MENU items, Fn (Function) button, and settings, and if a function cannot be set, the reason why.

1. Press the MENU or Fn button.
2. Select the desired MENU item using up/down/left/right side on the control wheel.

3. Press the button to which the [In-Camera Guide] function is assigned.

The operation guide for the MENU item you have selected in step 2 is displayed.

- If you press the ● on the center of the control wheel after selecting an item shown in gray, the reason the item cannot be set is displayed.

Note

- Assign the [In-Camera Guide] function to a button in advance using the [Custom Key(Shoot.)].

[12] How to Use | Preparing the camera | Charging the battery pack

Charging the battery pack using a charger

When using the camera for the first time, be sure to charge the battery pack. The charged battery pack is discharged little by little, even when you do not use it. To avoid missing an opportunity to shoot, charge the battery pack again before you shoot.

1. Insert the battery pack into the battery charger.

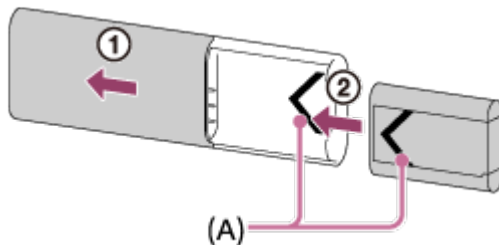

- Slide the top cover of the battery charger to open it, and then insert the battery pack until it clicks by aligning the ▼ marks **(A)** on both the battery pack and the battery charger.
2. Slide the top cover of the battery charger to close it.
3. Connect the battery charger to the AC Adaptor (supplied) using the micro USB cable (supplied), and connect the AC Adaptor to a wall outlet (wall socket). Alternatively, you can charge the battery from a computer by connecting the battery charger to a USB jack on a computer connected to a power source.

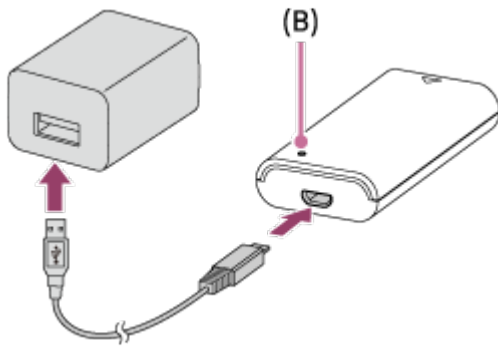

- The CHARGE lamp **(B)** lights orange when charging is started.
- The CHARGE lamp turns off when charging is finished.
- If the CHARGE lamp lights up and then immediately turns off, the battery pack is fully charged.
- For some countries/regions, connect the power cord to the AC Adaptor and then connect the AC Adaptor to a wall outlet (wall socket) when you charge the battery pack using the AC Adaptor.

Charging time

The charging time is approximately 155 min. using the AC Adaptor (supplied) and the battery charger (supplied).

- The charging time above is the time when charging a fully depleted battery pack (supplied) at a temperature of 25°C (77°F). Charging may take longer depending on the conditions of use and the surrounding environment.

Note

- If the CHARGE lamp does not light up, check if the battery pack is firmly attached to the battery charger, and then disconnect and reconnect the micro USB cable.
- Connect the battery charger directly to the computer, not via a USB hub, etc.

[13] How to Use | Preparing the camera | Charging the battery pack

Inserting the battery pack into the camera

How to insert the battery pack into the camera

1. Open the battery cover.

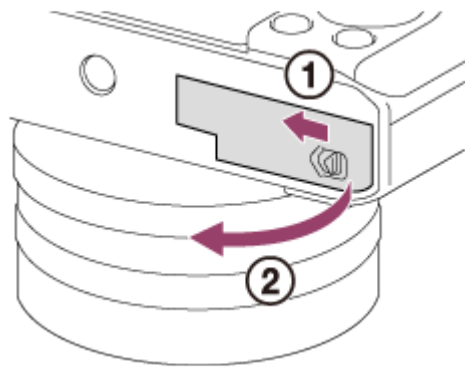

2. Insert the battery pack while pressing the lock lever **(A)** with the tip of the battery until the battery locks into place.

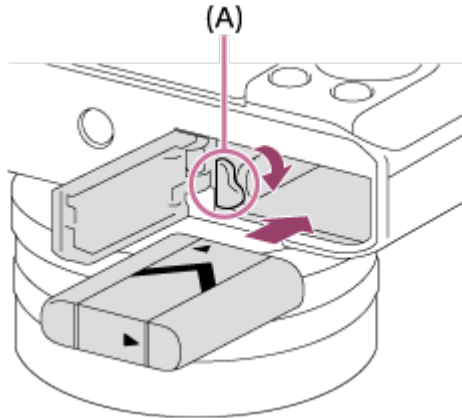

3. Close the cover.

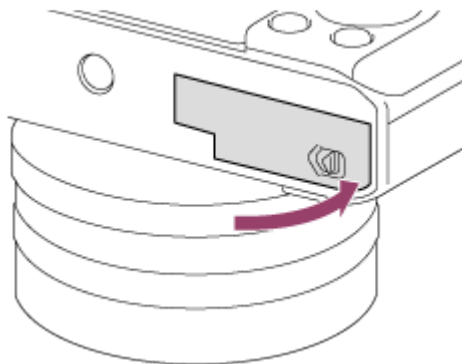

[14] How to Use | Preparing the camera | Charging the battery pack

Charging the battery pack while it is inserted in the camera

When using the camera for the first time, be sure to charge the battery pack. The charged battery pack will discharge little by little, even if you do not use it. To avoid missing a shooting opportunity, charge the battery pack before shooting.

1. Turn the power off.
2. Connect the camera with the battery pack inserted to the AC Adaptor (supplied) using the micro USB cable (supplied), and connect the AC Adaptor to the wall outlet (wall socket).

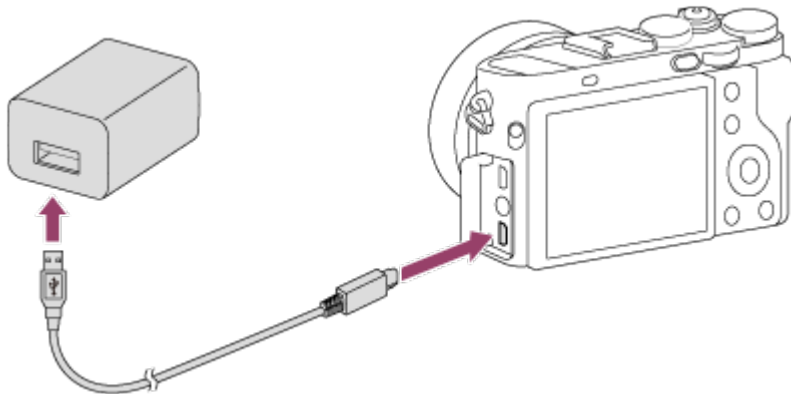

Charge lamp

Lit: Charging

Off: Charging finished

Flashing: Charging error or charging paused temporarily because the camera is not within the proper temperature range

- If the charge lamp lights up once and then immediately turns off, the battery pack is fully charged.

Charging time (Full charge)

The charging time is approximately 150 min. using the AC Adaptor (supplied).

- The charging time may differ depending on the remaining capacity of the battery pack or the charging conditions.
- The battery pack can be charged even when it is not fully depleted.
- The above charging time applies when charging a fully depleted battery pack (supplied) at a temperature of 25°C (77°F). Charging may take longer depending on the conditions of use and the environment.

Note

- If the charge lamp flashes when the battery pack is not fully charged, remove the battery pack or disconnect the USB cable from the camera and then re-insert it to recharge.
- If the charge lamp on the camera flashes when the AC Adaptor is connected to the wall outlet (wall socket), this indicates that charging is temporarily stopped because the temperature is outside the recommended range. When the temperature gets back within the appropriate range, the charging resumes. We recommend charging the battery pack at an ambient temperature of between 10°C to 30°C (50°F to 86°F).
- Connect the AC Adaptor to the nearest wall outlet (wall socket). If malfunctions occur while using the AC Adaptor, immediately disconnect the plug from the wall outlet (wall

socket) to disconnect from the power source.

- When you use a completely new battery pack or a battery pack that has not been used for a long time, the charge lamp may flash quickly when the battery is charged. If this happens, remove the battery pack or disconnect the USB cable from the camera and then re-insert it to recharge.
- Do not continuously or repeatedly charge the battery pack without using it if it is already fully charged or close to fully charged. Doing so may cause a deterioration in battery performance.
- When charging is finished, disconnect the AC Adaptor from the wall outlet (wall socket).
- Be sure to use only genuine Sony brand battery packs, micro USB cables (supplied) and AC Adaptors (supplied).

[15] How to Use | Preparing the camera | Charging the battery pack

Charging by connecting to a computer

The battery pack can be charged by connecting the camera to a computer using a micro USB cable.

1. Turn off the product, and connect to the USB terminal of the computer.



Note

- Note the following points when charging via a computer:
 - If the product is connected to a laptop computer that is not connected to a power source, the laptop battery level decreases. Do not leave the product connected to a laptop computer for an extended period of time.
 - Do not turn on/off or restart the computer, or wake the computer from sleep mode when a USB connection has been established between the computer and the camera. Doing so may cause a malfunction. Before turning on/off or restarting the computer, or waking the computer from sleep mode, disconnect the camera from the computer.
 - Proper operation cannot be guaranteed on all types of computers.
 - Charging cannot be guaranteed with a custom-built computer, modified computer, or a computer connected through a USB hub.
 - The camera may not operate correctly when other USB devices are used at the same time.

Battery life and the number of images that can be recorded/played back using a battery pack

Screen mode

Shooting (still images):

Number of images: approx. 220

Actual shooting (movies):

Battery life: approx. 30 min.

Continuous shooting (movies):

Battery life: approx. 50 min.

Viewing (still images):

Battery life: approx. 170 min., Number of images: approx. 3400

Viewfinder mode

Shooting (still images):

Number of images: approx. 200

Actual shooting (movies):

Battery life: approx. 30 min.

Continuous shooting (movies):

Battery life: approx. 50 min.

Note

- The above battery life and number of images applies when the battery pack has been fully charged. The battery life and number of images may decrease depending on the conditions of use.
- The battery life and number of images that can be recorded is for shooting under the following conditions:
 - The battery pack is used at an ambient temperature of 25°C (77°F).
 - Using Sony Memory Stick PRO Duo (Mark2) media (sold separately)
 - [Viewfinder Bright.]: [Manual][±0]
 - [Monitor Brightness]: [Manual][±0]
 - [Display Quality]: [Standard]
- The number for “Shooting (still images)” is based on the CIPA standard, and is for shooting under the following conditions (CIPA: Camera & Imaging Products Association):
 - DISP: [Display All Info.]
 - Focus Mode: [Single-shot AF]
 - One picture is taken every 30 seconds.
 - The power is turned on and off once every ten times.

- The number of minutes for movie shooting is based on the CIPA standard, and is for shooting under the following conditions:
 - The image quality is set to 60i 17M (FH) .
 - Actual shooting (movies): Battery life based on repeated shooting, shooting stand-by, turning on/off, etc.
 - Continuous movie shooting: Battery life based on non-stop shooting until the limit (29 minutes) has been reached, and then continued by pressing the MOVIE (Movie) button again. Other functions are not used.
- If the remaining battery is not displayed, press the DISP (Display Setting).

[17] How to Use | Preparing the camera | Charging the battery pack

Supplying power from a wall outlet (wall socket)

By using the supplied AC adaptor, you can shoot and playback images while the power is supplied from a wall outlet (wall socket) without using up the battery power.

1. Insert the battery pack into the camera.
2. Connect the camera to the wall outlet (wall socket) with a micro USB cable (supplied) and an AC adaptor (supplied).

Note

- The camera will not activate if there is no remaining battery. Insert a sufficiently charged battery pack into the camera.
- If you use the camera while power is being supplied from a wall outlet (wall socket), make sure that the icon () is displayed on the monitor.
- Do not remove the battery pack while power is supplied from a wall outlet (wall socket). If you remove the battery pack, the camera will be turned off.
- Do not remove the battery pack while the access lamp is lit. The data in the memory card may be damaged.
- As long as the power is on, the battery pack will not be charged even if the camera is connected to the AC Adaptor.
- Under certain conditions, power may be supplied from the battery pack supplementarily even if you are using the AC adaptor.
- Do not remove the Micro USB cable while power is supplied from a wall outlet (wall socket). Before you remove the Micro USB cable, turn off the camera.
- Depending on the camera and battery temperature, the continuous recording time may be shortened while power is supplied from a wall outlet (wall socket).
- When using a mobile charger as a power source, confirm that it is fully charged before

use. Also, be careful of the remaining power on the mobile charger during use.

[18] How to Use | Preparing the camera | Charging the battery pack

Removing the battery pack

How to remove the battery pack

1. Make sure that the access lamp is not lit, and turn off the camera.
2. Slide lock lever **(A)** and remove the battery pack.

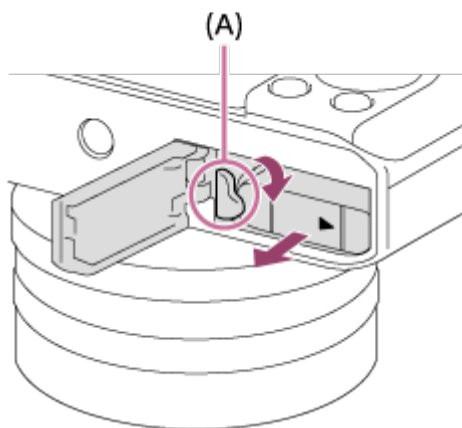

- Be careful not to drop the battery pack.

[19] How to Use | Preparing the camera | Inserting a memory card (sold separately)

Inserting a memory card

How to insert a memory card

1. Open the memory card cover.

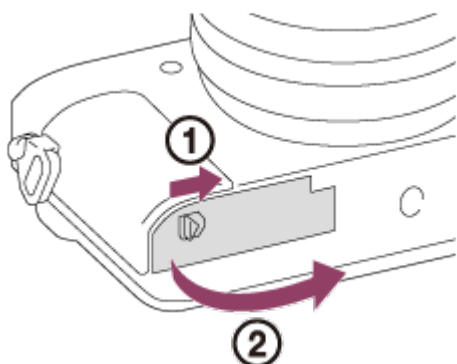

2. Insert the memory card.

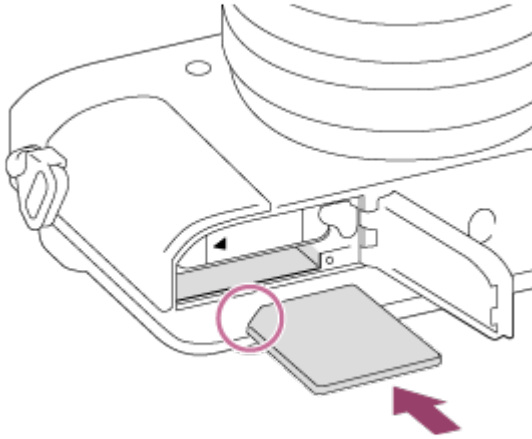

- Ensure that the notched corner is facing in the correct direction.
- With the notched corner facing in the direction illustrated, insert the memory card until it clicks into place.

3. Close the memory card cover.

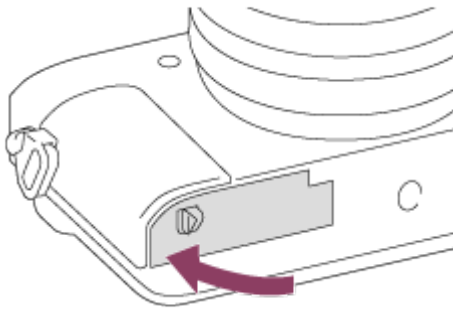

Hint

- When you use a memory card with this product for the first time, it is recommended that you format the card using the product for stable performance of the memory card.

[20] How to Use | Preparing the camera | Inserting a memory card (sold separately)

Removing the memory card

How to remove the memory card

1. Open the memory card cover.
2. Make sure that the access lamp **(A)** is not lit.

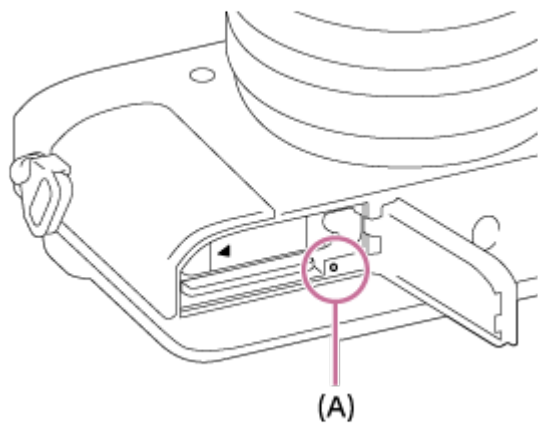

3. Push in on the memory card once to remove it.

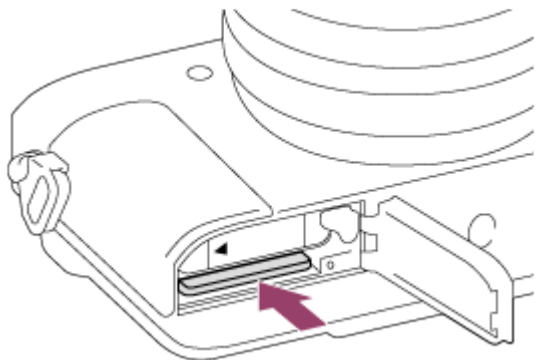

4. Close the memory card cover.

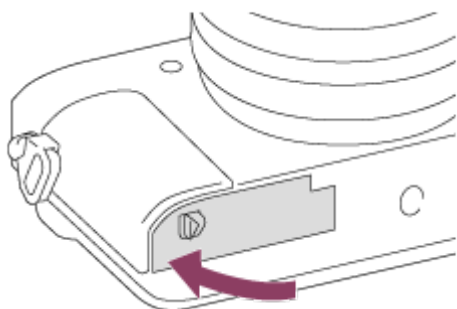

[21] How to Use | Preparing the camera | Inserting a memory card (sold separately)

Usable memory cards

You can use the following types of memory cards with this camera.

For movies, refer to “Memory cards that can be used for movie recording” on this page.

Usable Memory Stick media

- Memory Stick PRO Duo / Memory Stick PRO Duo (Mark2)
- Memory Stick PRO-HG Duo

- Memory Stick Micro (M2) (Mark2)

*Memory Stick media with a capacity of up to 32 GB have been tested and proven to operate with this camera.

Usable SD cards

- SD memory card / SDHC memory card
- SDXC memory card
- microSD memory card / microSDHC memory card
- microSDXC memory card

*SD cards with a capacity of up to 128 GB have been tested and proven to operate with this camera.

Memory cards that can be used for movie recording

When shooting movies in XAVC S format

SDXC memory card or microSDXC memory card with a capacity of 64 GB or more (SD Speed Class 10, or UHS Speed Class U1 or faster)

When shooting movies in AVCHD or MP4 format

- Memory Stick PRO Duo (Mark2)
- Memory Stick PRO-HG Duo
- Memory Stick Micro (M2) (Mark2)
- SD memory card / microSD memory card (SD Speed Class 4 or faster, or UHS Speed Class U1 or faster)
- SDHC memory card / microSDHC memory card (SD Speed Class 4 or faster, or UHS Speed Class U1 or faster)
- SDXC memory card / microSDXC memory card (SD Speed Class 4 or faster, or UHS Speed Class U1 or faster)

Note

- Not all memory cards are guaranteed to operate correctly.
- When you use a memory card with the camera for the first time, it is recommended that you format the card on the camera before use for more stable performance of the memory card.

Note that formatting erases all data on the memory card permanently, and is irreversible. Save valuable data on a computer, etc.

- Images recorded on an SDXC memory card cannot be imported to or played on computers or AV devices that are not compatible with exFAT when connected using a micro USB cable. Make sure that the device is compatible with exFAT before connecting it to the camera. If you connect your camera to an incompatible device, you may be prompted to format the card. Never format the card in response to this prompt, as doing so will erase all data on the card. (exFAT is the file system used on SDXC memory

cards.)

[22] How to Use | Preparing the camera | Setting the language, date and time

Setting language, date and time

When you turn on the camera for the first time or after you have initialized the functions, the setting screen for language, date and time will appear.

1. Turn on the camera.
The language setting screen will appear and then setting screen for date and time will appear.
2. Select your language, and then press ●.
3. Check that [Enter] is selected on the screen, then press ● on the control wheel.
4. Select your desired geographic location, and then press ●.
5. Select a setting item using the up/down side of the control wheel or by turning the control wheel, then press ● in the center.
6. Set [Daylight Savings], [Date/Time], and [Date Format] using the up/down/left/right sides, then press ● in the center.
 - Midnight is indicated as 12:00 AM, and noon as 12:00 PM.
7. Repeat steps 5 and 6 to set other items, then select [Enter] and press ● in the center.
 - To cancel the date and time setting procedure, press the MENU button.

Note

- If the date and time setting is cancelled halfway, the setting screen for the date and time appears every time you turn on the camera.

[23] How to Use | Confirming the operation method | Confirming the operation method

Using the control wheel

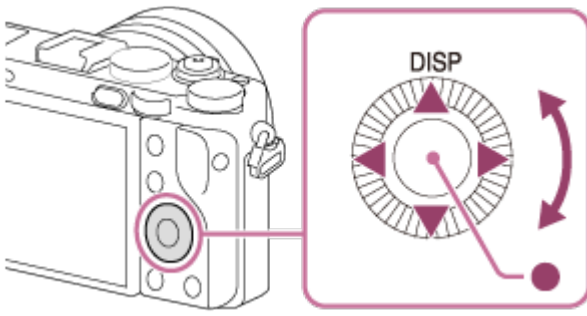

You can select setting items by turning or pressing the top/bottom/right/left side of the control wheel. Your selection is determined when you press ● on the center of the control wheel.

The DISP (Display Setting) is assigned to the top side of the control wheel. You can assign selected functions to the left/right/bottom side of the control wheel or to ● in the center, and to the rotation of the control wheel.

During playback, you can display the next/previous image by pressing the right/left side of the control wheel or by turning the control wheel.

[24] How to Use | Confirming the operation method | Confirming the operation method

Using the control dial

By turning the control dial **(A)**, you can instantly change settings as needed for various shooting modes.

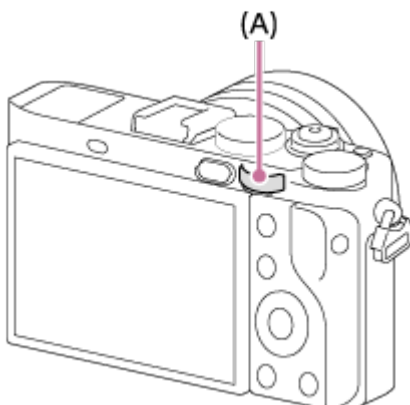

Icons and function names are displayed on the screen as follows.

Ex.

 Tv: shutter speed

Using MENU items

In this section, you learn how to change settings related to all camera operations and execute camera functions including shooting, playback, and operation methods.

1. Press MENU button to display the MENU items.

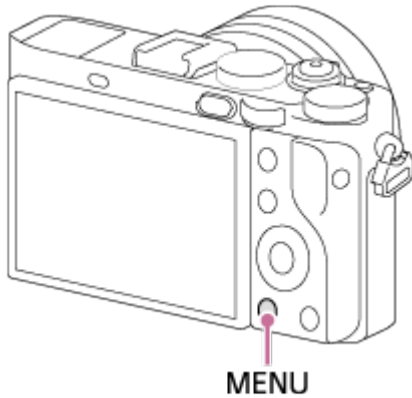

2. Select the desired MENU item using the up/down/left/right side of the control wheel or by turning the control wheel, and then press ● in the center of the control wheel.
 - The display may move directly from step 1 to step 3 depending on the [Tile Menu] setting.

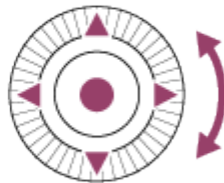
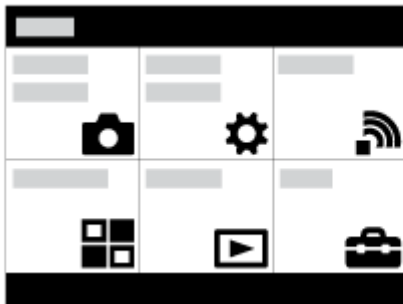

3. Select the desired setting item by pressing the up/down/left/right side on the control wheel or by turning the control wheel, and then press ● on the center of the control wheel.
 - Select an icon at the top of the screen and press the left/right side of the control wheel to move to another MENU item.

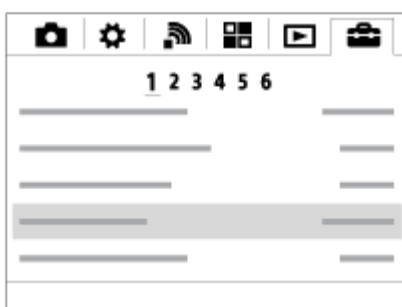

4. Select the desired setting value, and press ● to confirm.

[26] How to Use | Confirming the operation method | Confirming the operation method

Using the Fn (Function) button

You can register frequently used functions to the Fn (function) button and recall them while shooting. Up to 12 frequently used functions can be registered to the Fn (Function) button.

1. Press the DISP button, and then press the Fn (Function) button in a screen mode other than [For viewfinder].

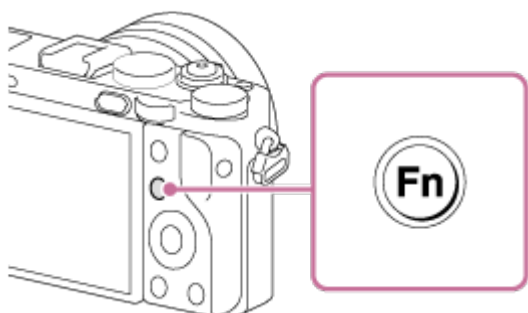

2. Select a function to be registered by pressing the up/down/left/right side of the control wheel.

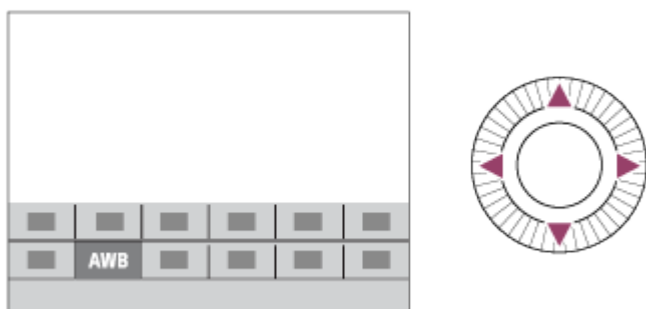

3. Select the desired setting by turning the control wheel, and press ● in the center of the control wheel.
 - Some functions can be fine-tuned using the control dial.

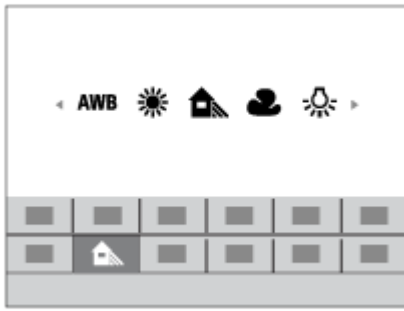

Performing settings on the dedicated screen

Select the desired function in step 2, then press ● on the center of the control wheel. The dedicated setting screen for the function appears. Follow the operating guide (A) to perform the settings.

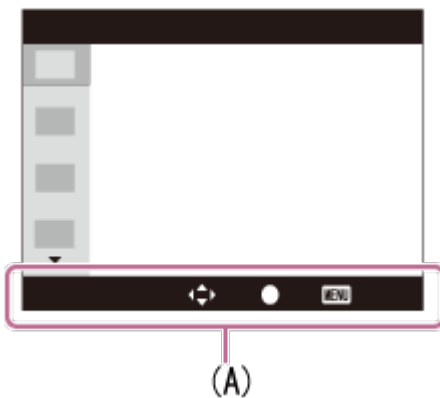

[27] How to Use | Confirming the operation method | Confirming the operation method Using the "Quick Navi"

You can change the settings directly using the Quick Navi screen when using the viewfinder. The displayed contents and their position are just a guideline, and may differ from the actual display.

1. MENU →  (Custom Settings) → [DISP Button] → [Monitor] → [For viewfinder] → [Enter].
2. Press the DISP (Display Setting) button on the control wheel repeatedly until the screen is set to [For viewfinder].
3. Press Fn (Function) button to switch the screen to Quick Navi screen.

In Auto Mode or Scene Selection mode



In P/A/S/M/Sweep Panorama mode



4. Select the desired function by pressing the up/down/left/right side of the control wheel.
5. Turn the control wheel to select the desired setting.
 - Some setting values can be finely adjusted by turning the control dial.

Performing settings on the dedicated screen

Select the desired function in step 4, then press ● on the center of the control wheel. The dedicated setting screen for the function appears. Follow the operating guide (A) to perform the settings.

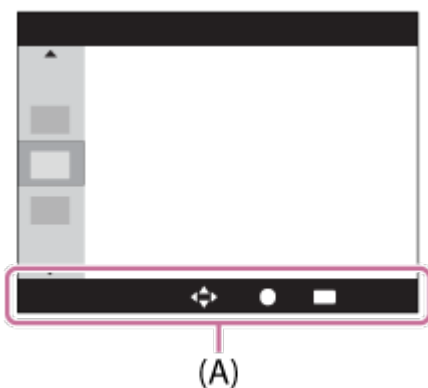

Note

- Gray items on the Quick Navi screen are not available.
- When using [Creative Style], some of the setup tasks can be accomplished only on a designated screen.

Shooting still images

Shoots still images.

1. Set the shooting mode to **AUTO** (Auto Mode).

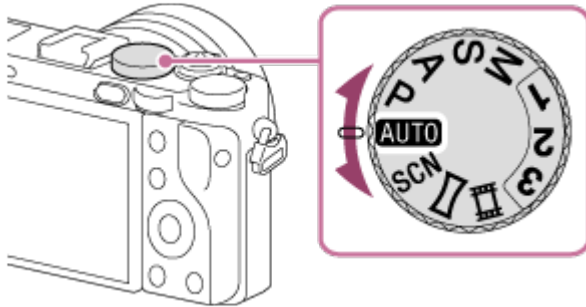

2. Adjust the monitor angle, and hold the camera. Or look through the viewfinder and hold the camera.
3. Press the shutter button halfway down to focus.
When the image is in focus, the indicator (● or (●●)) lights up.

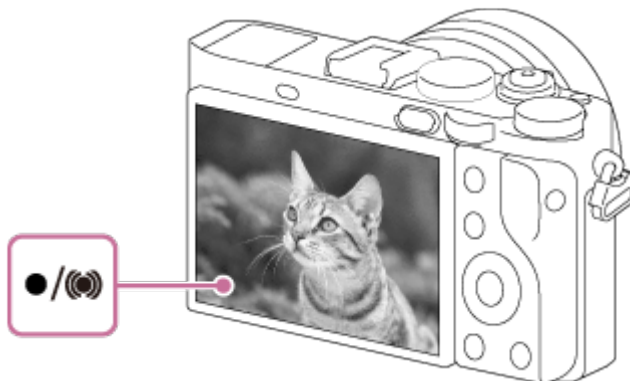

- The shortest shooting distance is approximately 30 cm (1 ft.) from the image sensor.

4. Press the shutter button fully down.

Focus indicator

● lights:
Image is in the focus.

● flashes:
The focusing has failed.

(●●) lights:
Image is in the focus. The focused position will change to suit the motion of the subject.

(●) lights:
The focusing is in progress.

Hint

- When the product cannot focus automatically, the focus indicator flashes and the beep does not sound. Either recompose the shot or change the focus setting.
- Focusing may be difficult in the following situations:
 - It is dark and the subject is distant.
 - The contrast of the subject is poor.
 - The subject is seen through glass.
 - The subject is moving quickly.
 - There is reflective light or shiny surfaces.
 - There is a flashing light.
 - The subject is backlit.
 - Continuously repetitive pattern, such as the appearance of a building.
 - The subjects in the focus area have different focal distances.
- If you turn the macro switching ring **(A)** to “0,2 m-0,35 m”, the shooting mode will switch to macro. The shortest shooting distance will now be approximately 0.2 m (0.65 ft.). Macro is useful for shooting close-ups of subjects such as flowers or food.

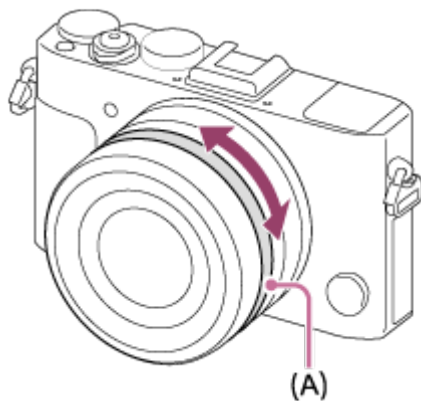

[29] How to Use | Shooting | Shooting still images/movies

Shooting movies

You can record movies by pressing the MOVIE (Movie) button.

1. Press the MOVIE button to start recording.

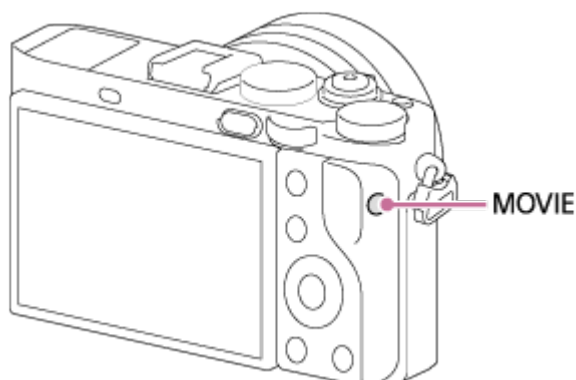



2. Press the MOVIE button again to stop recording.

Hint

- You can assign the start/stop movie recording function to a preferred key. MENU →  (Custom Settings) → [Custom Key(Shoot.)] → set the function to the preferred key.
- When you want to specify the area to be focused on, set the area using [Focus Area].
- To keep the focus on a face, arrange the composition so that the focus area frame and face detection frame overlap, or set the [Focus Area] to [Wide].

Note

- To adjust the shutter speed and aperture value to the desired settings, set the shooting mode to  (Movie).
- The sound of the MOVIE button operating may also be recorded when you press the MOVIE button to stop recording.
- For the continuous shooting time of a movie recording, refer to “Recordable time of movies.” When movie recording is finished, you can restart recording by pressing the MOVIE button again. Recording may stop to protect the product, depending on the temperature of the product or the battery.
- When shooting, the sound of the shoulder strap hooks (triangular hook) could be recorded, depending on the situation used.
- When the mode dial is set to  (Movie) or when shooting movies, you cannot select [Lock-on AF] for [Focus Area].

[30] How to Use | Shooting | Selecting a shooting mode

List of mode dial functions

You can select the desired shooting mode by turning the mode dial.

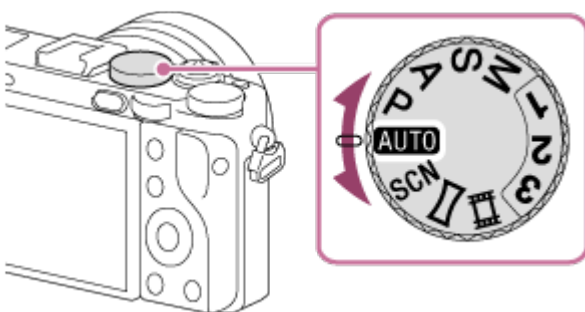

Available functions

AUTO (Auto Mode):

Allows you to shoot still images of any subject under any condition with good results by setting the values determined appropriate by the product.

P (Program Auto):

Allows you to shoot with the exposure adjusted automatically (both the shutter speed and the aperture value (F value)). Also you can select various settings using the menu.

A (Aperture Priority):

Allows you to adjust the aperture and shoot when you want to blur the background, etc.

S (Shutter Priority):

Allows you to shoot fast-moving subjects etc., by manually adjusting the shutter speed.

M (Manual Exposure):

Allows you to shoot still images with the desired exposure by adjusting the exposure (both the shutter speed and the aperture value (F value)).

1/2/3 (Memory recall):

Allows you to shoot an image after recalling often-used modes or numeric settings registered in advance.

(Movie):

Allows you to change the setting for movie recording.

(Sweep Panorama):

Allows you to shoot a panoramic image by compositing the images.

SCN (Scene Selection):

Allows you to shoot with preset settings according to the scene.

[31] How to Use | Shooting | Selecting a shooting mode

Intelligent Auto

The camera shoots with automatic scene recognition.

1. Set the mode dial to **AUTO** (Auto Mode).
2. MENU →  (Camera Settings) → [Auto Mode] → [Intelligent Auto].
 - When [Mode Dial Guide] is set to [On], you can select the desired settings after you have changed the position of the mode dial.
3. Point the camera to the subject.

When the camera recognized the scene, the icon for the recognized scene appears on the screen.



4. Adjust the focus and shoot the image.

Note



- The product will not recognize the scene when you shoot images with zoom functions.
- The product may not properly recognize the scene under certain shooting conditions.

[32] How to Use | Shooting | Selecting a shooting mode

Superior Auto

The camera shoots with automatic scene recognition. This mode takes clear images of dark or backlit scenes.

For low-lit or backlit scenes, if necessary the camera may shoot multiple images and create a composite image, etc., to record higher quality images than in Intelligent Auto mode.

1. Set the mode dial to **AUTO** (Auto Mode).
2. MENU →  (Camera Settings) → [Auto Mode] → [Superior Auto].
 - When [Mode Dial Guide] is set to [On], you can select the desired settings after you have changed the position of the mode dial.
3. Point the camera to the subject.
When the camera recognizes a scene, the scene recognition icon appears on the screen. If necessary,  (overlay icon) may appear.

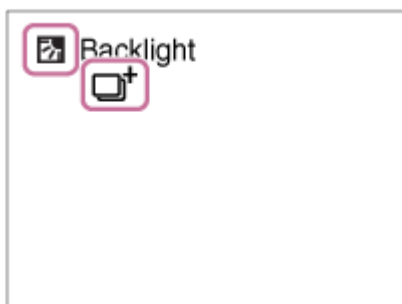

4. Adjust the focus and shoot the image.

Note

- When the product is used to create composite images, the recording process takes longer than usual.
- The product will not recognize the scene when you use zoom functions.
- The product may not properly recognize a scene under some shooting conditions.
- When [Quality] is set to [RAW] or [RAW & JPEG], the product cannot create a composite image.











[33] How to Use | Shooting | Selecting a shooting mode

About Scene Recognition





Scene Recognition operates in [Intelligent Auto] mode and [Superior Auto] mode. This function allows the product to automatically recognize the shooting conditions and shoot the image.

Scene Recognition:

When the product recognizes certain scenes, the following icons and guides are displayed on the first line:

-  (Portrait)
-  (Infant)
-  (Night Portrait)
-  (Night Scene)
-  (Backlight Portrait)
-  (Backlight)
-  (Landscape)
-  (Macro)
-  (Spotlight)
-  (Low Light)

When the product recognizes certain conditions, the following icons are displayed on the second line:

-  (Tripod)
-  (Move)
-  (Move (Bright))
-  (Move (Dark))

Note

- When [Smile/Face Detect.] is set to [Off], the [Portrait], [Backlight Portrait], [Night Portrait]

and [Infant] scenes are not recognized.

[34] How to Use | Shooting | Selecting a shooting mode

The advantages of automatic shooting

This camera is equipped with the following three automatic shooting modes: [Intelligent Auto], [Superior Auto], and [Program Auto].

(Intelligent Auto):

Allows you to shoot with automatic scene recognition.

(Superior Auto):

Allows you to shoot with automatic scene recognition. This mode takes clear images of dark or backlit scenes.

P (Program Auto):

Allows you to adjust various shooting settings such as white balance or ISO value, etc.

- Aperture value and shutter speed are automatically set by the camera.

Hint

- In [Superior Auto] mode and when the  (overlay icon) is displayed, be sure not to move the camera before the multiple shots are recorded.
- In [Program Auto] mode, you can change the combination of shutter speed and aperture value while maintaining the correct exposure by turning the control dial. This function is called "Program Shift" (**P***).

Note

- In [Superior Auto] mode, the recording process takes longer, since the product creates a composite image. In this case, the  (overlay icon) is displayed and the shutter sound is heard multiple times, but only one image is recorded.
 - For [Intelligent Auto] and [Superior Auto] mode, most of the functions are set automatically, and you cannot adjust the settings on your own.
-

[35] How to Use | Shooting | Selecting a shooting mode

Program Auto

Allows you to shoot with the exposure adjusted automatically (both the shutter speed and the aperture value).

You can set shooting functions such as [ISO].

1. Set the mode dial to P (Program Auto).
2. Set the shooting functions to your desired settings.
3. Adjust the focus and shoot the subject.

Program Shift

You can change the shutter speed and aperture (F-value) combination by rotating the control dial, without changing the appropriate exposure that is set by this product. This function is available when you do not use the flash.

- “P” on the screen changes to “P*” when you turn the control dial.
- To cancel program shift, set the shooting mode to other than [Program Auto], or turn off the camera.

Note

- According to the brightness of the environment, the program shift may not be used.
- Set the shooting mode to another one than “P” or turn off the power to cancel the setting you made.
- When the brightness changes, the aperture (F-value) and shutter speed also change while maintaining the shift amount.

[36] How to Use | Shooting | Selecting a shooting mode

Sweep Panorama

Allows you to create a single panoramic image from multiple images shot while panning the camera.



1. Set the mode dial to  (Sweep Panorama).
2. Point the camera at the subject.
3. While pressing the shutter button halfway down, aim the camera at one end of the desired panoramic composition.

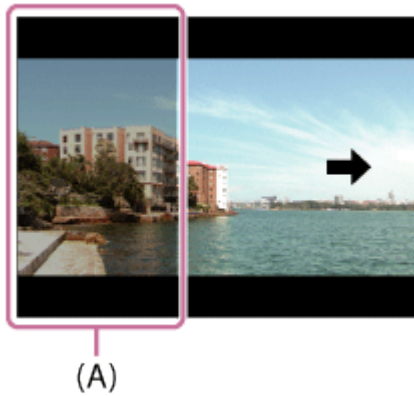

(A) This part will not be shot.

4. Press the shutter button fully down.
5. Pan the camera to the end of the guide in the direction of the arrow on the monitor.

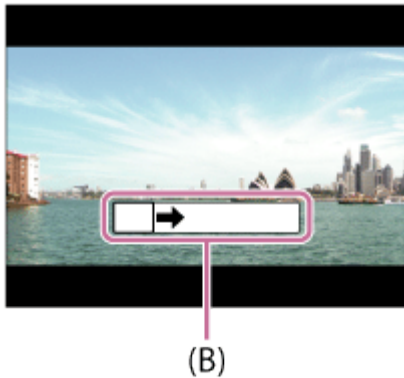

(B) Guidance bar

Note

- If the entire angle of the panoramic shot is not achieved within the set time, a gray area occurs in the composite image. If this happens, move the product faster to record the full panoramic image.
- When [Wide] is selected for [Panorama: Size], the entire angle of the panoramic shot may not be achieved within the given time. If this happens, try shooting after changing [Panorama: Size] to [Standard].
- Since several images are stitched together, the stitched part may not be recorded smoothly in some cases.
- The images may be blurred in dark scenes.
- When a light source such as a fluorescent light flickers, the brightness and color of a stitched image may not be consistent.
- When the whole angle of panoramic shooting and the AE/AF locked angle are very different in brightness and focus, the shooting may not be successful. If this happens, change AE/AF locked angle and shoot again.
- The following situations are not suited for shooting Sweep Panorama:

- Moving subjects.
 - Subjects that are too close to the product.
 - Subjects with continuously similar patterns, such as the sky, beach, or a lawn.
 - Subjects with constant change such as waves or water falls.
 - Subjects with brightness widely different from its surroundings such as the sun or a light bulb.
- The Sweep Panorama shooting may be interrupted in the following situations.
 - When the camera is panned too fast or too slow.
 - The subject is too blurry.

Hint

- You can turn the control dial on the shooting screen to select the shooting direction.

[37] How to Use | Shooting | Selecting a shooting mode

Scene Selection

Allows you to shoot with preset settings according to the scene.

1. Set the mode dial to SCN (Scene Selection).
2. Turn the control dial to select the desired setting.
 - When [Mode Dial Guide] is set to [On], you can select the desired settings after you have changed the position of the mode dial.

Menu item details

Portrait:

Blurs background and sharpens the subject. Accentuates the skin tones softly.



Sports Action:

Shoots a moving subject at a fast shutter speed so that the subject looks as if it is standing still. The product shoots images continuously while the shutter button is pressed.



Landscape:

Shoots the entire range of a scenery in sharp focus with vivid colors.



Sunset:

Shoots the red of the sunset beautifully.



Night Scene:

Shoots night scenes without losing the dark atmosphere.



Hand-held Twilight:

Shoots night scenes with less noise and blur without using a tripod. A burst of shots are taken, and image processing is applied to reduce subject blur, camera-shake, and noise.



Night Portrait:

Shoots night scene portraits using the flash.



Anti Motion Blur:

Allows you to shoot indoor shots without using the flash and reduces subject blur. The product shoots burst images and combines them to create the image, reducing subject blur

and noise.



Note

- Under the following settings, the shutter speed is slower, so use of a tripod is recommended to prevent the image from blurring:
 - [Night Scene]
 - [Night Portrait]
- In the [Hand-held Twilight] or [Anti Motion Blur] mode, the shutter clicks 4 times and an image is recorded.
- If you select [Hand-held Twilight] or [Anti Motion Blur] with [RAW] or [RAW & JPEG], the image quality becomes [Fine] temporarily.
- Reducing blur is less effective even in [Hand-held Twilight] or [Anti Motion Blur] when shooting the following subjects:
 - Subjects with erratic movement.
 - Subjects that are too close to the product.
 - Subjects with continuously similar patterns, such as the sky, a beach, or a lawn.
 - Subjects with constant change such as waves or water falls.
- In the case of [Hand-held Twilight] or [Anti Motion Blur], block noise may occur when using a light source that flickers, such as fluorescent lighting.

Hint

- To change the scene, rotate the control dial on the shooting screen and select a new scene.

[38] How to Use | Shooting | Selecting a shooting mode

Shutter Priority

You can express the movement of a moving subject in various ways by adjusting the shutter speed, for example, at the instant of the movement with high speed shutter, or as a trailing image with low speed shutter. The shutter speed can be changed while recording movies.

1. Set the mode dial to S (Shutter Priority).
2. Select the desired value by turning the control dial.

3. Adjust the focus and shoot the subject.

The aperture is automatically adjusted to obtain proper exposure.

Note

- If proper exposure cannot be obtained after setup, the aperture value on the shooting screen blinks. Although you can shoot as it is, resetting is recommended.
- Use a tripod to prevent blurring when you use a slow shutter speed.
- When the shutter speed is 1 second(s) or longer, noise reduction will be done after shooting for the same amount of time that the shutter was open. However, you cannot shoot any more while noise reduction is in progress.
- The brightness of the image on the monitor may differ from the actual image being shot.

Hint

- When a faster shutter speed is used, moving subjects, such as a running person, cars, or sea spray come out as if they are frozen in their movements. When a slower shutter speed is used, a trailing image of the movement of the subject is captured to create a more natural and dynamic image.

[39] How to Use | Shooting | Selecting a shooting mode

Aperture Priority

You can shoot by adjusting the aperture and changing the range in focus, or by defocusing the background. The aperture value can be changed while recording movies.

1. Set the mode dial to A (Aperture Priority).
2. Select the desired value by turning the aperture ring.
 - Smaller F-value: The subject is in focus, but objects in front of and beyond the subject are blurred.
Larger F-value: The subject and its foreground and background are all in focus.
3. Adjust the focus and shoot the subject.
The shutter speed is automatically adjusted to obtain proper exposure.

Note

- If proper exposure cannot be obtained after setup, the shutter speed on the shooting screen blinks. Although you can shoot as it is, resetting is recommended.
- The brightness of the image on the screen may differ from the actual image being shot.



Hint

- Smaller F-value (opening the aperture) narrows the range that is in focus. This allows you to put the subject in sharp focus and blur objects in front of and beyond the subject (depth of field becomes shallower). Larger F-value (narrowing down the aperture) widens the range that is in focus. This allows you to shoot the depth of the scenery (depth of field becomes deeper).

[40] How to Use | Shooting | Selecting a shooting mode

Manual Exposure

You can shoot with the desired exposure setting by adjusting both the shutter speed and aperture. The shutter speed and the aperture value can be changed while recording movies.

1. Set the mode dial to M (Manual Exposure).
2. Select the desired aperture value by turning the aperture ring.
Select the desired shutter speed by turning the control dial.
When [ISO] is set to other than [ISO AUTO], use MM (Metered Manual) to check the exposure value.
Toward +: Images become brighter.
Toward -: Images become darker.
0: Appropriate exposure analyzed by the product.
3. Adjust the focus and shoot the subject.

Note

- When [ISO] is set to [ISO AUTO], the ISO value automatically changes to achieve the appropriate exposure using the aperture value and shutter speed you have set. If the aperture value and shutter speed you have set are not suitable for appropriate exposure, the ISO value indicator will blink.
- The Metered Manual indicator does not appear when [ISO] is set to [ISO AUTO].
- When the amount of ambient light exceeds the metering range of the Metered Manual, the Metered Manual indicator flashes.
- The brightness of the image on the monitor may differ from the actual image being shot.

Hint

- You can change the shutter speed and aperture (F-value) combination without changing the set exposure value by rotating the aperture ring while pressing the AEL button. (Manual shift)

BULB

You can shoot a trailing image of the movement of a subject with long exposure.

BULB is suitable for shooting trails of light, such as fireworks.

1. Set the mode dial to M (Manual Exposure).
2. Turn the control dial clockwise until [BULB] is indicated.
3. Select the aperture value (F-value) using the aperture ring.
4. Press the shutter button halfway down to adjust the focus.
5. Press and hold the shutter button for the duration of the shooting.
As long as the shutter button is pressed, the shutter remains open.

Note

- Since the shutter speed becomes slow and the camera-shake tends to occur more easily, it is recommended that you use a tripod.
- The longer the exposure time, the more noise will be visible on the image.
- After shooting, noise reduction will be done for the same amount of time that the shutter was open. However, you cannot shoot any more while noise reduction is in progress.
- You cannot set the shutter speed to [BULB] in the following situations:
 - When the [Smile Shutter] function is activated.
 - When the [Auto HDR] function is activated.
 - When [Picture Effect] is set to [HDR Painting] or [Rich-tone Mono.].
 - When the [Multi Frame NR] function is activated.
 - When the [Drive Mode] function is set to the following modes:
 - [Cont. Shooting]
 - [Cont. Bracket]
 - [Spd Priority Cont.]
 - [Self-timer(Cont)]
 - [LPF Bracket]

If you use the above functions when the shutter speed is set to [BULB], the shutter speed is temporarily set to 30 seconds.

Hint

- Images shot in [BULB] mode tend to be blurry. We recommend that you use a tripod or a remote commander (sold separately) that has a shutter button lock function.

Memory recall

Allows you to shoot an image after recalling often-used modes or camera settings registered in advance.



1. Set the mode dial to 1, 2 or 3 (Memory recall).
2. Press  on the center of the control wheel.

Note

- Register shooting settings in advance by [Memory].
- If you set [Memory recall] after completing the shooting settings, the registered settings are given priority and the original settings may become invalid. Check the indicators on the screen before shooting.

Movie

You can adjust the shutter speed or aperture value to your desired settings for recording movies. You can also check the image angle before shooting.

1. Set the mode dial to  (Movie).
2. MENU →  (Camera Settings) → [Movie] → desired setting.
 - When [Mode Dial Guide] is set to [On], you can select the desired settings after you have changed the position of the mode dial.
3. Press the MOVIE (movie) button to start recording.
 - Press the MOVIE button again to stop recording.

Menu item details

Program Auto:

Allows you to shoot with the exposure adjusted automatically (both the shutter speed and the aperture value).

Aperture Priority:

Allows you to shoot after adjusting the aperture value manually.

Shutter Priority:

Allows you to shoot after adjusting the shutter speed manually.

Manual Exposure:

Allows you to shoot after adjusting the exposure (both the shutter speed and the aperture value) manually.

[44] How to Use | Using shooting functions | Using the zoom

Zoom

This product is not equipped with a zoom lens, but a zoom function is available.

1. MENU →  (Camera Settings) → [Zoom] → press the left/right side of the control wheel or turn the control wheel to adjust the zoom scale.

Hint

- When you select other than [Smart zoom only] for [Zoom Setting], you can exceed the zoom range of the smart zoom to zoom images.

[45] How to Use | Using shooting functions | Using the zoom

The zoom features available with this product

The zoom feature of the product provides a higher magnification zoom by combining various zoom features. The icon displayed on the screen changes, according to the selected zoom feature.

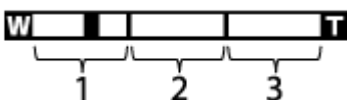

1. **Smart Zoom range** ()

Zoom images without causing the original quality to deteriorate by partially cropping an image (only when the image size is [M] or [S]).

2. **Clear Image Zoom range** ()





Zoom images using an image process with less deterioration. Set [Zoom Setting] to

[On:ClearImage Zoom] or [On:Digital Zoom] first.

3. **Digital Zoom range** ()

You can magnify images using an image process. When you select [On:Digital Zoom] for [Zoom Setting], you can use this zoom function.

Note

- The default setting for [ Image Size] is [L]. To use the smart zoom change [ Image Size] to [M] or [S].
- Zoom functions are not available when shooting in the following situations:
 - Shooting mode is set to [Sweep Panorama].
 - [ Quality] is set to [RAW] or [RAW & JPEG].
 - [ Record Setting] is set to [120p]/[100p].
- You cannot use the Smart Zoom function with movies.
- When you use zoom functions, [Metering Mode] is fixed to [Multi].
- When using zoom functions, the following functions are not available.
 - [Smile/Face Detect.]
 - Lock-on AF
 - [ Auto Obj. Framing]
- To use zoom function for movies, assign [Zoom] to the desired button using [Custom Key(Shoot.)].

[46] How to Use | Using shooting functions | Using the zoom

Zoom Setting

You can select the zoom setting of the product.

1. MENU →  (Custom Settings) → [Zoom Setting] → desired setting.

Menu item details

Smart zoom only:

Smart zoom is activated. You can use the Smart Zoom function if you set [ Image Size] to [M] or [S].

On:ClearImage Zoom:

Even if the zoom range of the smart zoom is exceeded, the product magnifies images within the range in which image quality does not deteriorate significantly.

On:Digital Zoom:

When the zoom range of the [ Clear Image Zoom] is exceeded, the product magnifies images to the largest scale. However, the image quality will deteriorate.

Note

- Set [Smart zoom only] if you want to magnify images within the range in which image quality does not deteriorate.

[47] How to Use | Using shooting functions | Using the zoom

About zoom scale

The zoom scale changes according to the selected image size.

When [Aspect Ratio] is [3:2]

[Zoom Setting]: [Smart zoom only]

[ Image Size]: L -, M 1.5x, S 2x

[Zoom Setting]: [On:ClearImage Zoom]

[ Image Size]: L 2x, M 3.1x, S 4x

[Zoom Setting]: [On:Digital Zoom]

[ Image Size]: L 4x, M 6.2x, S 8x

[48] How to Use | Using shooting functions | Using the zoom

Smart Telecon.

Smart Teleconverter magnifies and trims the center of the image, then records it.

1. MENU →  (Custom Settings) → [Custom Key(Shoot.)] → assign the [Smart Telecon.] function to the desired key.
2. Magnify an image by pressing the key to which you have assigned [Smart Telecon.].
The settings change each time you press the key.

[49] How to Use | Using shooting functions | Using the flash

Using flash (sold separately)

In dark environments, use the flash to light up the subject while shooting and to prevent camera-shake. When shooting against the sun, use the flash to lighten the image of the backlit subject.

1. Attach the flash (sold separately) to the product.

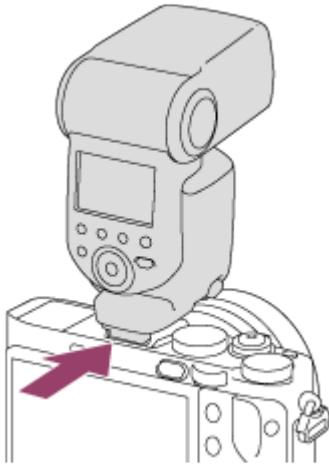

2. Press the shutter button fully down.

Note

- You cannot use the flash when recording movies.
- While charging the flash,  flashes. After charging is completed, the flashing icon will light up.
- Before attaching/removing an accessory such as a flash to/from the Multi Interface Shoe, turn off the product first.
When attaching an accessory, insert it fully to the Multi Interface Shoe and screw tightly. Also, make sure that the accessory is fixed securely to the product.
- If you raise the flash with the viewfinder up, the flash may make contact with the viewfinder. Be careful when doing so.
- Do not use a commercially available flash with high-voltage synchro terminals or with reverse polarity.

[50] How to Use | Using shooting functions | Using the flash

Notes on using the flash

When using the flash, note the following points.

- You cannot use the flash when recording movies.
- While charging the flash, the  indicator flashes. When the charging of the flash is

finished, the indicator lights up.

- Do not use a commercially available flash with high-voltage synchro terminals or with reverse polarity, it may cause a malfunction.

[51] How to Use | Using shooting functions | Using the flash

Flash Mode

You can set the flash mode.

1. MENU →  (Camera Settings) → [Flash Mode] → desired setting.

Menu item details

Flash Off:

The flash does not operate.

Autoflash:

The flash works in dark environments or when shooting towards bright light.

Fill-flash:

The flash works every time you trigger the shutter.

Slow Sync.:

The flash works every time you trigger the shutter. Slow sync shooting allows you to shoot a clear image of both the subject and the background by slowing the shutter speed.

Rear Sync.:

The flash works right before the exposure is completed every time you trigger the shutter. Rear sync shooting allows you to shoot a natural image of the trail of a moving subject such as a moving car or a walking person.

Wireless:

Using a wireless flash creates a shading effect that gives the subject a more 3D appearance than when using an attached flash.

This mode is effective when you attach a remote control-compatible external flash (sold separately) to the product, and shoot with a wireless flash (sold separately), placed away from the product.

Note

- The default setting depends on the shooting mode.
- Available flash mode depends on the shooting mode.

Flash Comp.

Adjusts the amount of flash light in a range of -3.0 EV to $+3.0$ EV.

Flash compensation changes the amount of flash light only. Exposure compensation changes the amount of flash light along with the change of the shutter speed and aperture.

1. MENU →  (Camera Settings) → [Flash Comp.] → desired setting.
Selecting higher values (+ side) makes the flash level higher, and lower values (– side) makes the flash level lower.

Note

- [Flash Comp.] does not work when the shooting mode is set to the following modes:
 - [Intelligent Auto]
 - [Superior Auto]
 - [Sweep Panorama]
 - [Scene Selection]
- The higher flash effect may not be visible due to the limited amount of flash light available, if the subject is outside the maximum range of the flash. If the subject is very close, the lower flash effect may not be visible.

Switching the screen display (Shooting)

You can change the display contents on the screen.

1. Press the DISP (Display Setting) button.
Each time you press the DISP button, the recording information display changes.

Graphic Display

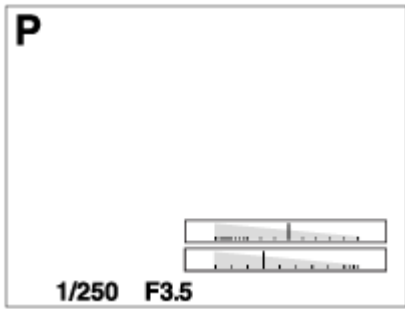

Display All Info.

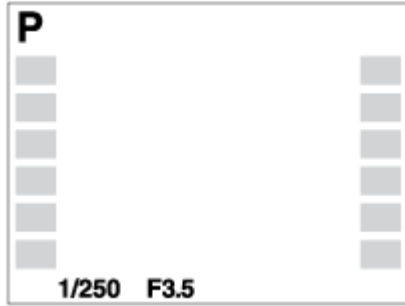

No Disp. Info.



Histogram

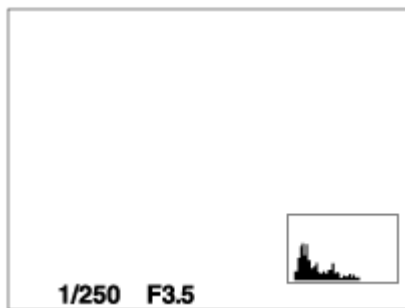

Level

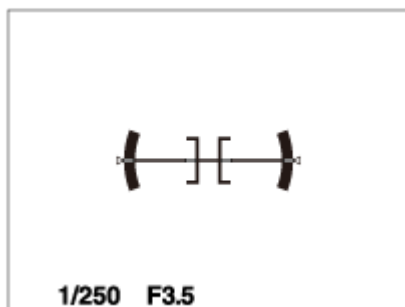

For viewfinder*

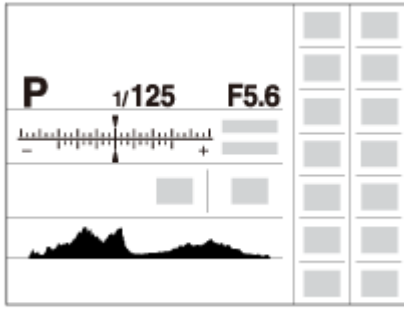

*[For viewfinder] is displayed only on the screen.



Some display modes are not available in the default settings.

To change the display modes, press MENU →  (Custom Settings) → [DISP Button] and change the setting.

Note

- Histogram is not displayed during panorama shooting.
- In movie mode, [For viewfinder] cannot be displayed.

Hint

- You can select different settings for both the viewfinder and the monitor. Look through the viewfinder to set the display settings for the viewfinder.
- To hide the grid lines displayed during still image shooting, select MENU →  (Custom Settings) → [Grid Line] → [Off].
- To hide the marker displayed during movie recording, select MENU →  (Custom Settings) → [ Marker Display] → [Off].

[54] How to Use | Using shooting functions | Selecting a screen display mode

Switching between the viewfinder and the screen

The displays on the viewfinder and screen may differ depending on the viewfinder status and the [FINDER/MONITOR] setting.

When the viewfinder is closed

The image is displayed on the screen only regardless of the [FINDER/MONITOR] setting.

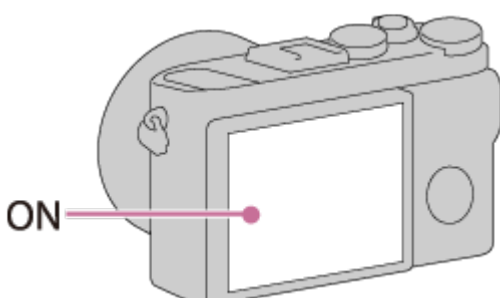

When you look into the viewfinder

If [FINDER/MONITOR] is set to [Auto] or [Viewfinder(Manual)], the image is displayed in the viewfinder only.

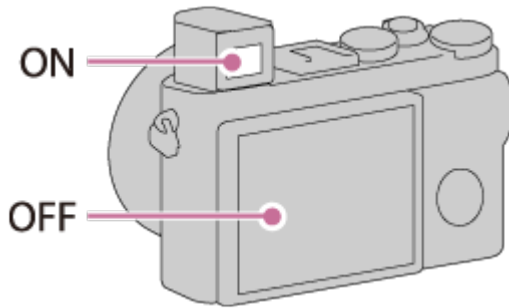

When you are not looking into the viewfinder

- If [FINDER/MONITOR] is set to [Auto] or [Monitor(Manual)], the image is displayed only on the screen.

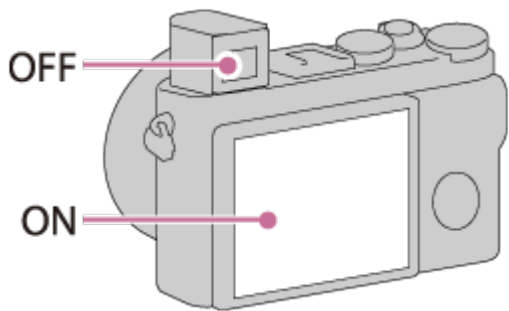

- If [FINDER/MONITOR] is set to [Viewfinder(Manual)], the image is displayed in the viewfinder only.

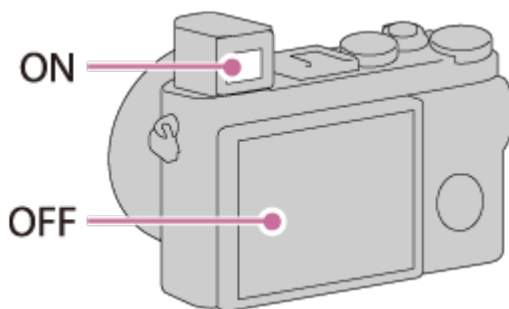

[55] How to Use | Using shooting functions | Selecting a screen display mode

DISP Button (Finder)

Allows you to set the screen display modes that can be selected for the viewfinder using **DISP** (Display Setting) in shooting mode.

1. MENU →  (Custom Settings) → [DISP Button] → [Finder] → desired setting → [Enter].

The items marked with  are available.

Menu item details

Graphic Display:

Shows basic shooting information. Graphically shows the shutter speed and aperture value.

Display All Info.:

Shows recording information.

No Disp. Info.:

Does not show recording information.

Histogram:

Displays the luminance distribution graphically.

Level:

Indicates whether the product is level in both the horizontal and front-back directions. When the product is level in both directions, the indicator turns to green.

[56] How to Use | Using shooting functions | Selecting a screen display mode

DISP Button (Monitor)

Allows you to set the screen display modes that can be selected for the monitor using **DISP** (Display Setting) in shooting mode.

1. MENU →  (Custom Settings) → [DISP Button] → [Monitor] → desired setting → [Enter].

The items marked with  are available.

Menu item details

Graphic Display:

Shows basic shooting information. Graphically shows the shutter speed and aperture value.

Display All Info.:

Shows recording information.

No Disp. Info.:

Does not show recording information.

Histogram:

Displays the luminance distribution graphically.

Level:

Indicates whether the product is level in both the horizontal and front-back directions. When the product is level in both directions, the indicator turns to green.



For viewfinder:

Displays information suited for shooting with the viewfinder.

[57] How to Use | Using shooting functions | Selecting still image size/image quality

Image Size (still image)

The larger the image size, the more detail will be reproduced when the image is printed on large-format paper. The smaller the image size, the more images can be recorded.

1. MENU →  (Camera Settings) → [ Image Size] → desired setting.

Menu item details

Image size when [ Aspect Ratio] is 3:2

L: 42M

7952x5304 pixels

M: 18M

5168x3448 pixels

S: 11M

3984x2656 pixels

Image size when [ Aspect Ratio] is 4:3

L: 38M

7072x5304 pixels

M: 16M

4592x3448 pixels

S: 9.4M

3536x2656 pixels

Image size when [ Aspect Ratio] is 16:9

L: 36M

7952x4472 pixels

M: 15M

5168x2912 pixels

S: 8.9M

3984x2240 pixels

Image size when [Aspect Ratio] is 1:1

L: 28M

5296x5296 pixels

M: 12M

3440x3440 pixels

S: 7.1M

2656x2656 pixels



Note

- When [ Quality] is set to [RAW] or [RAW & JPEG], the image size for RAW images corresponds to [L].

[58] How to Use | Using shooting functions | Selecting still image size/image quality

Aspect Ratio (still image)

Sets the aspect ratio of still images.

1. MENU →  (Camera Settings) → [ Aspect Ratio] → desired setting.

Menu item details

3:2:

Suitable for standard prints.

4:3:

For shooting in a size suitable for viewing on a computer.

16:9:

For viewing on a high-definition TV.



1:1:

For shooting in composition as a medium format camera.

[59] How to Use | Using shooting functions | Selecting still image size/image quality

Quality (still image)

Selects the compression format of still images.

1. MENU →  (Camera Settings) → [ Quality] → desired setting.

Menu item details

RAW:

File format: RAW

Digital processing is not performed on this file format. Select this format to process images on a computer for professional purposes.

- The image size is fixed to the maximum size. The image size is not displayed on the screen.

RAW & JPEG:

File format: RAW + JPEG

A RAW image and a JPEG image are created at the same time. This is suitable when you need 2 image files, a JPEG for viewing, and a RAW for editing.

The JPEG image quality is set to [Fine].

Extra fine:

File format: JPEG

The image is compressed in the JPEG format and recorded using a higher quality than with [Fine].

Fine:

File format: JPEG

The image is compressed in the JPEG format when recorded.

Standard:

File format: JPEG

The image is compressed in the JPEG format when recorded. Since the compression rate of [Standard] is higher than that of [Fine], the file size of [Standard] is smaller than that of [Fine]. This will allow more files to be recorded on 1 memory card, but the image quality will be lower.

About RAW images

- To open a RAW image file recorded with this camera, the software Image Data Converter is needed. With Image Data Converter, you can open a RAW image file, then convert it into a popular image format such as JPEG or TIFF, or readjust the white balance, saturation or contrast of the image.
- You cannot apply [Auto HDR] or [Picture Effect] functions with RAW images.
- RAW images recorded with this camera have a resolution of 14 bits per pixel. However, resolution is limited to 12 bits in the following shooting modes:
 - [ Long Exposure NR]
 - [BULB]
 - Continuous shooting (including continuous shooting in [Superior Auto] mode.)

Note

- If you do not intend to edit the images on your computer, we recommend that you record



in JPEG format.

- You cannot add DPOF (print order) registration marks to RAW images.

[60] How to Use | Using shooting functions | Selecting still image size/image quality

RAW File Type (still image)

Selects the file type for RAW images.

1. MENU →  (Camera Settings) → [ RAW File Type] → desired setting.

Menu item details



RAW Compressed:

Records images in compressed RAW format.

RAW Uncompressed:

Records images in uncompressed RAW format. When [Uncompressed] is selected for [ RAW File Type], the file size of the image will be larger than if it were recorded in compressed RAW format.

Note

- When [Uncompressed] is selected for [ RAW File Type], the icon on the screen switches to  .  is also displayed while an image shot in uncompressed RAW format is played back.

[61] How to Use | Using shooting functions | Selecting still image size/image quality

Panorama: Size

Sets the image size when shooting panoramic images. The image size varies depending on the [Panorama: Direction] setting.

1. MENU →  (Camera Settings) → [Panorama: Size] → desired setting.

Menu item details

When [Panorama: Direction] is [Up] or [Down]

Standard: 3872x2160

Wide: 5536x2160

When [Panorama: Direction] is [Left] or [Right]

Standard: 8192×1856

Wide: 12416×1856

[62] How to Use | Using shooting functions | Selecting still image size/image quality

Panorama: Direction

Sets the direction to pan the camera when shooting panoramic images.

1. MENU →  (Camera Settings) → [Panorama: Direction] → desired setting.

Menu item details

Right:

Pan the camera from the left to the right.

Left:

Pan the camera from the right to the left.

Up:

Pan the camera from the bottom to the top.

Down:

Pan the camera from the top to the bottom.

[63] How to Use | Using shooting functions | Adjusting the focus

Changing the focus method using the focus mode dial

You can select the focusing method to suit the movement of the subject.

1. Turn the focus mode dial **(A)** to select the desired focus method.

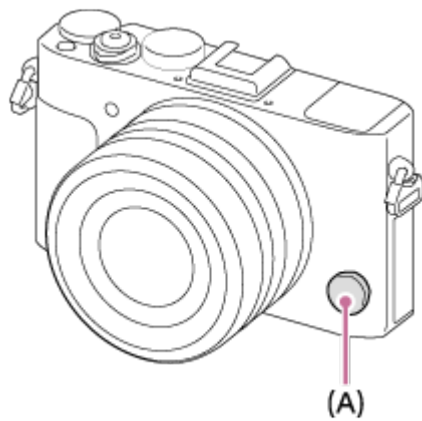

Focus mode details

S (Single-shot AF):

The camera focuses and the focus is locked when you press the shutter button halfway down. Use this mode when the subject is motionless.

C (Continuous AF):

The camera continues to focus while the shutter button is pressed and held halfway down. Use this mode when the subject is in motion.

DMF (DMF):

After focusing automatically, make fine focus adjustment manually (Direct Manual Focus).

MF (Manual Focus):

Adjusts the focus manually.

Note

- If the subject is too close, the image may show any dust or fingerprints on the lens. Wipe the lens with a soft cloth, etc.
- Once you change the focus method, the set focus distance is erased.
- When [Focus Mode] is set to [Continuous AF], the beep does not sound when focus is achieved.

Hint

- If you cannot achieve focus for the intended subject using auto focus, select MF or DMF, then shoot again.

[64] How to Use | Using shooting functions | Adjusting the focus

Focus Area

Selects the focusing area. Use this function when it is difficult to get the proper focus in auto focus mode. The setting applies to both still images and movies.

1. MENU →  (Camera Settings) → [Focus Area] → desired setting.

Menu item details

Wide:

Focuses automatically on a subject in all ranges of the image.

When you press the shutter button halfway down in still image shooting mode, a green frame is displayed around the area that is in focus.

Center:

Focuses automatically on a subject in the center of the image. When used together with the AF lock function, you can compose the image you want.

Flexible Spot:

Allows you to move the AF range frame to the desired point on the screen and focus on an extremely small subject in a narrow area.

Expand Flexible Spot:

If the product fails to focus on the single selected point, it uses the focus points around the flexible spot as the second priority area to achieve focus.

Lock-on AF:

When the shutter button is pressed and held halfway down, the product tracks the subject within the selected autofocus area. Point the cursor to [Lock-on AF] on the [Focus Area] setting screen, then select the desired tracking start area using the left/right sides of the control wheel. You can move the tracking start area to a desired point by designating the area to be the flexible spot or expand flexible spot.

Note

- When the mode dial is set to  (Movie) or when shooting movies, you cannot select [Lock-on AF] for [Focus Area].
- You can select [Lock-on AF] only when the focus mode is set to [Continuous AF].
- A dotted square may appear around the whole screen in the clear image zoom, digital zoom, or smart zoom range in order to focus using the entire frame.

[65] How to Use | Using shooting functions | Adjusting the focus

Phase detection AF

When there are phase detection AF points within the auto focus area, the product uses the combined autofocus of the phase detection AF and contrast AF.





Note

- When the F-value is set to F9.0 or more, you cannot use the phase detection AF. Only contrast AF is available.

[66] How to Use | Using shooting functions | Adjusting the focus

Center Lock-on AF

When you press the center button, the camera detects the subject positioned in the center of the screen and continues to track the subject.

1. MENU →  (Camera Settings) → [Center Lock-on AF] → [On].
2. Align the target frame (A) over the subject and press  in the center of the control wheel.
Press  again to stop tracking.
 - If the camera loses track of the subject, it can detect when the subject reappears on the monitor and resume tracking.

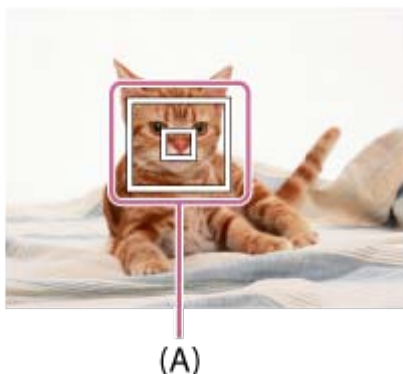

3. Press the shutter button fully down to shoot the image.

Note

- [Center Lock-on AF] may not function very well in the following situations:
 - The subject is moving too quickly.
 - The subject is too small, or too large.
 - The contrast between the subject and the background is poor.
 - It is dark.
 - The ambient light changes.
- Lock-on AF does not work in the following situations:
 - In [Sweep Panorama] mode
 - When [Scene Selection] is set to [Hand-held Twilight] or [Anti Motion Blur]

- When shooting in Manual Focus mode
- When using the digital zoom
- The camera may not be able to resume tracking for a while after it loses the track of the subject.

[67] How to Use | Using shooting functions | Adjusting the focus

Focus-lock

Shoots images with the focus locked on the desired subject in auto focus mode.

1. Select AF-S by rotating the focus mode dial.
2. Place the subject within the AF area and press the shutter button halfway down.
The focus is locked.
3. Keep pressing the shutter button halfway down, and place the subject back in the original position to re-compose the shot.
4. Press the shutter button down fully to take the picture.

[68] How to Use | Using shooting functions | Adjusting the focus

Manual Focus

When it is difficult to get the proper focus in autofocus mode, you can adjust the focus manually. The setting applies to both still images and movies.

1. Rotate the focus mode dial to select MF.
2. Rotate the focus ring to achieve sharp focus.

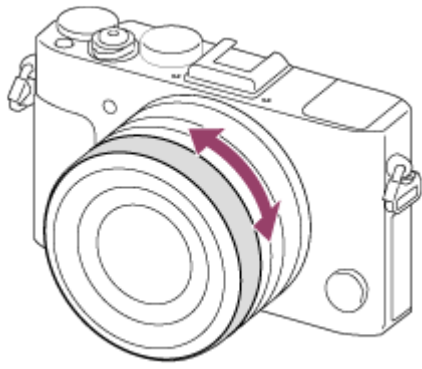

- When you rotate the focus ring, the focus distance is displayed on the screen.

3. Press the shutter button fully down to take the picture.

Note

- When you use the viewfinder, adjust the diopter level to obtain the correct focus on the viewfinder.
- If you re-select the [Focus Mode], any focus distance that you set manually will be canceled.

[69] How to Use | Using shooting functions | Adjusting the focus

Direct manual focus (DMF)

You can make fine adjustments manually after the focus is locked.

You can quickly focus on a subject rather than using the manual focus from the beginning.

This is convenient in cases such as macro shooting.

1. Select DMF by rotating the focus mode dial.
2. Press the shutter button halfway down to focus automatically.
3. Keep the shutter button halfway down, rotate the focusing ring to achieve a sharper focus.

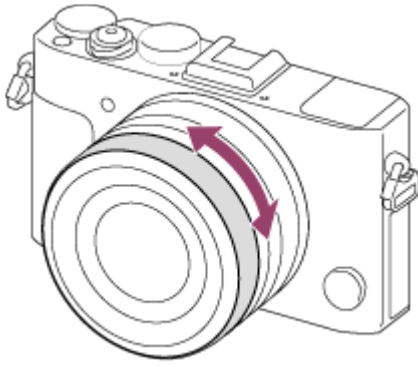



- When you rotate the focus ring, the focus distance is displayed on the screen.

4. Press the shutter button fully down to shoot an image.

[70] How to Use | Using shooting functions | Adjusting the focus

MF Assist (still image)

Enlarges the image on the screen automatically to make manual focusing easier. This works in Manual Focus or Direct Manual Focus shooting.

1. MENU →  (Custom Settings) → [ MF Assist] → [On].
2. Turn the focus ring to adjust the focus.
 - The image is enlarged. You can magnify images further by pressing  on the center of the control wheel.

Note

- You cannot use [ MF Assist] when shooting movies.



Hint

- You can set how long the image is to be shown magnified by selecting MENU →  (Custom Settings) → [Focus Magnif. Time].

[71] How to Use | Using shooting functions | Adjusting the focus

Focus Magnifier

You can check the focus by enlarging the image before shooting.

1. MENU →  (Camera Settings) → [Focus Magnifier].
2. Press  on the center of the control wheel to enlarge the image and select the position you want to enlarge using up/down/left/right side of the control wheel.
 - When  is pressed for the third time, the focus magnifier closes and the normal shooting display is restored.
3. Confirm the focus.
4. Press the shutter button fully down to shoot the image.

Hint

- When focusing manually, you can adjust the focus while an image is magnified.
- The [Focus Magnifier] function will be canceled when the shutter button is pressed halfway.
- You can record images while an image is enlarged, but the product records a full-display image.
- The [Focus Magnifier] function will be canceled after shooting.
- You can set how long the image is to be shown magnified by selecting MENU →  (Custom Settings) → [Focus Magnif. Time].

[72] How to Use | Using shooting functions | Adjusting the focus

Focus Magnif. Time

Set the duration for which an image is to be magnified using the [ MF Assist] or [Focus Magnifier] function.

1. MENU →  (Custom Settings) → [Focus Magnif. Time] → desired setting.

Menu item details

2 Sec:

Magnifies the images for 2 seconds.

5 Sec:

Magnifies the images for 5 seconds.

No Limit:

Magnifies the images until you press the shutter button.

Peaking Level

Enhances the outline of in-focus ranges using a specific color in Manual Focus or Direct Manual Focus shooting. This function allows you to confirm the focus easily. The setting applies to both still images and movies.

1. MENU →  (Custom Settings) → [Peaking Level] → desired setting.

Menu item details

High:

Sets the peaking level to high.

Mid:

Sets the peaking level to middle.

Low:

Sets the peaking level to low.

Off:

Does not use the peaking function.

Note

- Since the product determines that sharp areas are in focus, the effect of peaking differs, depending on the subject and shooting conditions.
- The outline of in-focus ranges is not enhanced when the product is connected using an HDMI cable.

Peaking Color

Sets the color used for the peaking function in Manual Focus or Direct Manual Focus shooting. The setting applies to both still images and movies.

1. MENU →  (Custom Settings) → [Peaking Color] → desired setting.

Menu item details

Red:

Enhances outlines in red.

Yellow:

Enhances outlines in yellow.



White:

Enhances outlines in white.

[75] How to Use | Using shooting functions | Adjusting the focus

Pre-AF (still image)

The product automatically adjusts focus before you press the shutter button halfway down.

1. MENU →  (Custom Settings) → [ Pre-AF] → desired setting.

Menu item details

On:

Adjusts focus before you press the shutter button halfway down.

Off:

Does not adjust focus before you press the shutter button halfway down.

[76] How to Use | Using shooting functions | Adjusting the focus

AF/MF control

You can easily switch the focusing mode from auto to manual and vice versa while shooting without changing your holding position. The setting applies to both still images and movies.

1. MENU →  (Custom Settings) → [Custom Key(Shoot.)] → button to be assigned → [AF/MF Control Hold] or [AF/MF Ctrl Toggle].

Menu item details

AF/MF Control Hold:

Switches the focusing mode while the button is held down.

AF/MF Ctrl Toggle:

Switches the focusing mode until the button is pressed again.



Note

- You cannot set the [AF/MF Control Hold] function to [Left Button], [Right Button] or [Down Button].

[77] How to Use | Using shooting functions | Adjusting the focus

AF Illuminator (still image)

The AF illuminator supplies fill light to focus more easily on a subject in dark surroundings. The red AF illuminator allows the product to focus easily when the shutter button is pressed halfway, until the focus is locked.

1. MENU →  (Camera Settings) → [ AF Illuminator] → desired setting.

Menu item details

Auto:

Uses the AF illuminator.

Off:

Does not use the AF illuminator.

Note

- You cannot use [ AF Illuminator] in the following situations:
 - In movie mode
 - In [Sweep Panorama] mode
 - When [Focus Mode] is set to [Continuous AF].
 - When [Scene Selection] is set to the following modes:
 - [Landscape]
 - [Sports Action]
 - [Night Scene]
- The AF illuminator emits a very bright light. Although there is no health hazard, do not look directly into the AF illuminator at close range.

[78] How to Use | Using shooting functions | Adjusting the focus

Disp. cont. AF area

You can set whether or not to display the area that is in focus when [Focus Area] is set to [Wide], in [Continuous AF] mode.

1. MENU →  (Custom Settings) → [Disp. cont. AF area] → desired setting.

Menu item details

On:

Displays the focus area that is in focus.

Off:

Does not display the focus area that is in focus.

Note

- When [Focus Area] is [Center], [Flexible Spot] or [Expand Flexible Spot], the frames in the focus area that is in focus turn green, regardless of the [Disp. cont. AF area] settings.

[79] How to Use | Using shooting functions | Adjusting the focus

Eye AF

The camera focuses on the subject's eyes while you keep the button pressed.

1. MENU →  (Custom Settings) → [Custom Key(Shoot.)] → assign the [Eye AF] function to the desired button.
2. Point the camera at a person's face, and press the button to which you have assigned the [Eye AF] function.
3. Press the shutter button while pressing the button.

Hint

- When the camera focuses on the eyes, a detection frame is displayed over the eyes. If the focus mode is set to [Single-shot AF], the frame will disappear after a period of time.

Note

- The camera may not be able to focus on the eyes depending on the circumstances, such as when no eyes can be detected within the auto focus area. In such cases, the camera detects a face and focuses on the face.
- If the camera cannot detect a person's face, you cannot use [Eye AF].

- Depending on the circumstances, you cannot use [Eye AF], such as when [Focus Mode] is set to [Manual Focus], etc.
- [Eye AF] may not function in the following situations:
 - When the person is wearing sunglasses.
 - When the front hair covers the person's eyes.
 - In low-light or back-lit conditions.
 - When the eyes are closed.
 - When the person is in the shade.
 - When the person is out of focus.
 - When the person is moving too much.
- If the person is moving too much, the detection frame may not display correctly over their eyes.

[80] How to Use | Using shooting functions | Adjusting the focus

Phase Detect. Area

Sets whether or not to display the Phase Detection AF area.

1. MENU →  (Custom Settings) → [Phase Detect. Area] → desired setting.

Menu item details

On:

Displays the Phase Detection AF area.

Off:

Does not display the Phase Detection AF area.

Note

- When the F-value is F9.0 or more, Phase Detection AF cannot be used. Only Contrast AF is available.
- When recording movies, the Phase Detection AF area will not be displayed.

[81] How to Use | Using shooting functions | Adjusting the focus

Measuring the exact distance to the subject

The  mark shows the location of the image sensor*. When you measure the exact

distance between the product and the subject, refer to the position of the horizontal line.

*The image sensor is the part that converts the light source to a digital signal.

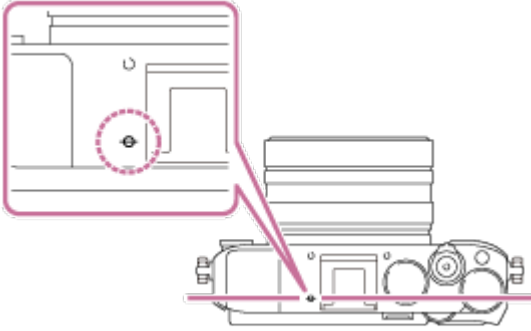

Note

- If the subject is closer than the minimum shooting distance of the lens, the focus cannot be confirmed. Make sure you put enough distance between the subject and the product.

[82] How to Use | Using shooting functions | Adjusting the focus

Priority Set in AF-S

Sets whether to release the shutter even if the subject is not in focus when [Focus Mode] is set to [Single-shot AF] or [DMF] and the subject is remaining still.

1. MENU → ⚙️ (Custom Settings) → [Priority Set in AF-S] → desired setting.

Menu item details

AF:

Prioritizes focusing. The shutter will not be released until the subject is in focus.

Release:

Prioritizes the shutter's release. The shutter will be released even if the subject is out of focus.

Balanced Emphasis:

Shoots with a balanced emphasis on both focusing and shutter release.

[83] How to Use | Using shooting functions | Adjusting the focus

Priority Set in AF-C

Sets whether to release the shutter even if the subject is not in focus when [Continuous AF] is activated and the subject is in motion.

1. MENU →  (Custom Settings) → [Priority Set in AF-C] → desired setting.

Menu item details

AF:

Prioritizes focusing. The shutter will not be released until the subject is in focus.

Release:

Prioritizes the shutter's release. The shutter will be released even if the subject is out of focus.

Balanced Emphasis:

Shoots with a balanced emphasis on both focusing and shutter release.

[84] How to Use | Using shooting functions | Adjusting the exposure

Exposure Comp.

You can adjust the exposure under MENU when the exposure compensation dial is set to “0.” Based on the exposure value set by auto exposure, you can make the entire image brighter or darker if you adjust [Exposure Comp.] to the plus side or minus side, respectively (exposure compensation). Normally, exposure is set automatically (auto exposure).

1. MENU →  (Camera Settings) → [Exposure Comp.] → desired setting.
 - You can adjust the exposure in a range of -5.0 EV to $+5.0$ EV when the exposure compensation dial is set to “0.”

Note

- You can adjust the exposure in a range of -2.0 EV to $+2.0$ EV for movies.
- If you shoot a subject in extremely bright or dark conditions, or when you use the flash, you may not be able to get a satisfactory effect.
- Only a value between -3.0 EV and $+3.0$ EV with the equivalent image brightness appears on the screen when shooting. If you set an exposure beyond this range, the image brightness on the screen does not show the effect, but it will be reflected in the recorded image.
- When the exposure compensation dial is set to other than “0,” settings for the exposure compensation dial will be prioritized. For example, if you set [Exposure Comp.] to $+3.0$ EV,

but the exposure compensation dial is set to +2.0 EV, the “+2.0 EV” setting will be prioritized.

- When you set the exposure compensation dial to “0” from a setting other than “0,” the exposure value switches to “0” even if the exposure has been set to other settings.
- When you use [Manual Exposure], you can compensate for the exposure only when [ISO] is set to [ISO AUTO].

[85] How to Use | Using shooting functions | Adjusting the exposure

Exposure compensation dial

Based on the exposure value set by auto exposure, you can make the entire image brighter or darker if you adjust [Exposure Comp.] to the plus side or minus side, respectively (exposure compensation). Normally, exposure is set automatically (auto exposure).

1. Turn the exposure compensation dial.

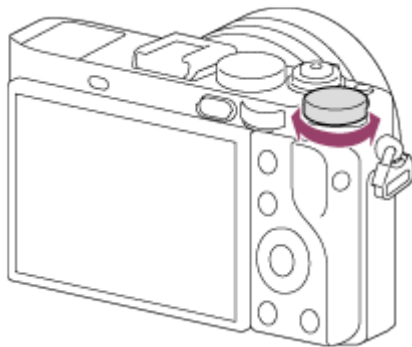

Note

- You can adjust the exposure in a range of -2.0 EV to +2.0 EV for movies.
- If you shoot a subject in extremely bright or dark conditions, or when you use the flash, you may not be able to get a satisfactory effect.
- When you use [Manual Exposure], you can compensate for the exposure only when [ISO] is set to [ISO AUTO].

[86] How to Use | Using shooting functions | Adjusting the exposure

Metering Mode

Selects the metering mode that sets which part of the screen to measure for determining the exposure.

1. MENU →  (Camera Settings) → [Metering Mode] → desired setting.

Menu item details

Multi:

Measures light on each area after dividing the total area into multiple areas and determines the proper exposure of the entire screen (Multi-pattern metering).

Center:

Measures the average brightness of the entire screen, while emphasizing the central area of the screen (Center-weighted metering).

Spot:

Measures only the central area (Spot metering). This function is useful when the subject is backlit or when there is strong contrast between the subject and the background.

Note

- The setting is fixed to [Multi] in the following shooting modes:
 - [Intelligent Auto]
 - [Superior Auto]
 - [Scene Selection]
 - Zoom functions

[87] How to Use | Using shooting functions | Adjusting the exposure

AE lock

When the contrast between the subject and background is high, such as when shooting a backlit subject or a subject near a window, meter the light at a spot where the subject appears to have the appropriate brightness and lock the exposure before shooting. To reduce the brightness of the subject, meter the light at a spot brighter than the subject and lock the exposure of the entire screen. To make the subject brighter, meter the light at a spot darker than the subject and lock the exposure of the entire screen.

1. Adjust the focus on the spot at which the exposure is adjusted.
2. Press the AEL button.

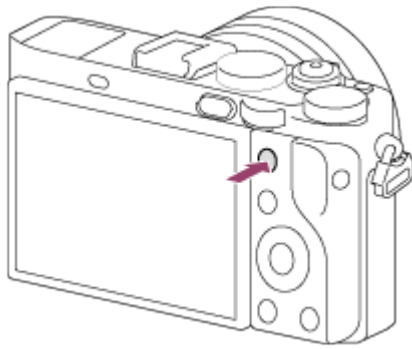

The exposure is locked, and ***** (AE lock) lights up.

3. Keep pressing the AEL button and focus on the subject again, then shoot the picture.
 - Keep holding the AEL button down while taking a shot if you want to continue shooting with the fixed exposure. Release the button to reset the exposure.

Hint

- If you select the [AEL toggle] function in **⚙** (Custom Settings) → [Custom Key(Shoot.)], you can lock the exposure without holding down the AEL button.

[88] How to Use | Using shooting functions | Adjusting the exposure

AEL w/ shutter (still image)

Sets whether to fix the exposure when you press the shutter button halfway down. This function is useful when you want to adjust focus and exposure separately.

1. MENU → **⚙** (Custom Settings) → [ AEL w/ shutter] → desired setting.

Menu item details

Auto:

Fixes the exposure after adjusting the focus automatically when you press the shutter button halfway down when [Focus Mode] is set to [Single-shot AF].

On:

Fixes the exposure when you press the shutter button halfway down.

Off:

Does not fix the exposure when you press the shutter button halfway down. Use this mode when you want to adjust focus and exposure separately.

The product keeps adjusting the exposure while shooting in [Cont. Shooting] or [Spd Priority Cont.] mode.

Note

- Operation using the AEL button is prioritized over the [ AEL w/ shutter] settings.

[89] How to Use | Using shooting functions | Adjusting the exposure

Exp.comp.set

Sets whether to apply the exposure compensation value to control both flash light and ambient light, or just ambient light.

1. MENU →  (Custom Settings) → [Exp.comp.set] → desired setting.

Menu item details

Ambient&flash:

Applies the exposure compensation value to control both flash light and ambient light.

Ambient only:

Applies the exposure compensation value to control ambient light only.

[90] How to Use | Using shooting functions | Adjusting the exposure

Zebra

The zebra pattern will appear over part of an image if the brightness level of that part meets the IRE level that you set. Use this zebra pattern as a guide to adjust the brightness.

1. MENU →  (Custom Settings) → [Zebra] → desired setting.

Menu item details

Off:

Does not display the zebra pattern.

70/75/80/85/90/95/100/100+:

Adjusts the brightness level.

Note

- The zebra pattern is not displayed during HDMI connection.

Exposure Set. Guide

You can set whether to display a guide when you change the exposure.

1. MENU →  (Custom Settings) → [Exposure Set. Guide] → desired setting.

Menu item details

Off:

Does not display the guide.

On:

Displays the guide.

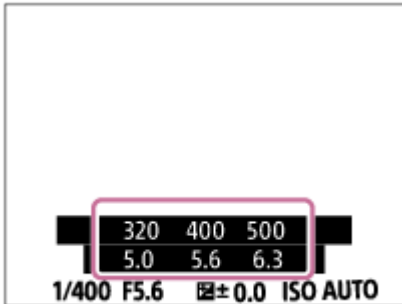

Reset EV Comp.

Sets whether to maintain the exposure value set using [Exposure Comp.] when you turn off the power when the exposure compensation dial position is set to “0.”

1. MENU →  (Custom Settings) → [Reset EV Comp.] → desired setting.

Menu item details

Maintain:

Maintains the settings of [Custom Settings].

Reset:

Resets the settings of [Exposure Comp.] to “0.”

Drive Mode

You can set the drive mode, such as continuous or self-timer shooting.

1. MENU →  (Camera Settings) → [Drive Mode] → desired setting.

Menu item details

Single Shooting:

Shoots one still image. Normal shooting mode.

Cont. Shooting:

Shoots images continuously while you press and hold down the shutter button.

Spd Priority Cont.:

Shoots images continuously at high speed while you press and hold down the shutter button.

Self-timer:

Shoots an image using the self-timer after a designated number of seconds have elapsed since the shutter button was pressed.

Self-timer(Cont):

Shoots a designated number of images using the self-timer after a designated number of seconds have elapsed since the shutter button was pressed.

BRK C Cont. Bracket:

Shoots images while holding the shutter button down, each with different degrees of brightness.

BRK S Single Bracket:

Shoots a specified number of images, one by one, each with a different degree of brightness.

BRK WB WB bracket:

Shoots a total of three images, each with different color tones according to the selected settings for white balance, color temperature and color filter.

BRK DRO DRO Bracket:

Shoots a total of three images, each at a different degree of D-Range Optimizer.

BRK C LPF Bracket:

Shoots a total of three images with [LPF Effect] set to [Standard], [High], and [Off] for one image each.

Note

- When the shooting mode is set to [Scene Selection] and [Sports Action] is selected, [Single Shooting] cannot be performed.

Cont. Shooting

Shoots images continuously while you press and hold down the shutter button.

1. MENU →  (Camera Settings) → [Drive Mode] → [Cont. Shooting].

Note

- Continuous shooting is unavailable in the following situations:
 - The shooting mode has been set to [Sweep Panorama].
 - The shooting mode is set to [Scene Selection] and a scene other than [Sports Action] is selected.
 - The [Picture Effect] is set to [Soft Focus], [HDR Painting], [Rich-tone Mono.], [Miniature], [Watercolor], or [Illustration].
 - The [DRO/Auto HDR] is set to [Auto HDR].
 - [ISO] is set to [Multi Frame NR].
 - [Smile Shutter] is being used.

Hint

- To hold the focus and exposure during burst, change the following settings.
 - Set [Focus Mode] to [Continuous AF].
 - Set [ AEL w/ shutter] to [Off] or [Auto].

Spd Priority Cont.

The product continues to shoot as long as the shutter button is pressed. You can continuously shoot at a rate faster than that of [Cont. Shooting].

1. MENU →  (Camera Settings) → [Drive Mode] → [Spd Priority Cont.].

Note

- Between continuous shooting frames, an image of each frame is immediately displayed.
- Continuous shooting is unavailable in the following situations:

- The shooting mode has been set to [Sweep Panorama].
- The shooting mode is set to [Scene Selection] and a scene other than [Sports Action] is selected.
- The [Picture Effect] is set to [Soft Focus], [HDR Painting], [Rich-tone Mono.], [Miniature], [Watercolor], or [Illustration].
- The [DRO/Auto HDR] is set to [Auto HDR].
- [ISO] is set to [Multi Frame NR].
- [Smile Shutter] is being used.

Hint

- The product continues to adjust focus and exposure during [Spd Priority Cont.].
To keep adjusting the focus and exposure throughout continuous shooting, select the following settings. The exposure of the first shot is determined when you press the shutter button halfway down, and the camera continues adjusting the exposure for subsequent shots.
 - Set [Focus Mode] to [Continuous AF].
When the Phase Detection AF is not used, the product does not continue focusing even if [Focus Mode] is set to [Continuous AF].
 - Set [ AEL w/ shutter] to [Auto] or [Off].

[96] How to Use | Using shooting functions | Selecting a drive mode (Continuous shooting/Self-timer)

Self-timer

Shoots an image using the self-timer after a designated number of seconds have elapsed since the shutter button was pressed.

1. MENU →  (Camera Settings) → [Drive Mode] → [Self-timer].
2. Select the desired mode using the right/left side of the control wheel.

Menu item details

Self-timer: 10 Sec:

Sets the 10-second delay self-timer.

When you press the shutter button, the self-timer lamp flashes, a beep sounds, and the shutter operates after 10 seconds. To cancel the self-timer, press the shutter button again.

Self-timer: 5 Sec:

Sets the 5-second delay self-timer.



When you press the shutter button, the self-timer lamp flashes, a beep sounds, and the shutter operates after 5 seconds. To cancel the self-timer, press the shutter button again.

Self-timer: 2 Sec:

Sets the 2-second delay self-timer. This reduces the camera-shake caused by pressing the

shutter button.

Hint

- To cancel the self-timer, select MENU →  (Camera Settings) → [Drive Mode] → [Single Shooting].
- To use the self-timer in bracket mode, select bracket mode under drive mode, then select MENU →  (Camera Settings) → [Bracket Settings] → [Selftimer during Brkt].

Note

- The self-timer is unavailable in the following situations:
 - The shooting mode is set to [Sweep Panorama].
 - [Sports Action] in [Scene Selection]
 - [Smile Shutter]

[97] How to Use | Using shooting functions | Selecting a drive mode (Continuous shooting/Self-timer)

Self-timer(Cont)

Shoots a designated number of images using the self-timer after a designated number of seconds have elapsed since the shutter button was pressed. You can choose the best from multiple shots.

1. MENU →  (Camera Settings) → [Drive Mode] → [Self-timer(Cont)].
2. Select the desired mode using the right/left side of the control wheel.

Menu item details

Self-timer(Cont.): 10 Sec. 3 Img.:

Shoots three frames in succession 10 seconds after you press the shutter button.

When you press the shutter button, the self-timer lamp flashes, a beep sounds, and the shutter operates after 10 seconds.

Self-timer(Cont.): 10 Sec. 5 Img.:

Shoots five frames in succession 10 seconds after you press the shutter button.

When you press the shutter button, the self-timer lamp flashes, a beep sounds, and the shutter operates after 10 seconds.

Self-timer(Cont.): 5 Sec. 3 Img.:

Shoots three frames in succession 5 seconds after you press the shutter button. When you press the shutter button, the self-timer lamp flashes, a beep sounds, and the shutter operates after 5 seconds.

Self-timer(Cont.): 5 Sec. 5 Img.:

Shoots five frames in succession 5 seconds after you press the shutter button. When you press the shutter button, the self-timer lamp flashes, a beep sounds, and the shutter operates after 5 seconds.

 **Self-timer(Cont.): 2 Sec. 3 Img.:**

Shoots three frames in succession 2 seconds after you press the shutter button. When you press the shutter button, the self-timer lamp flashes, a beep sounds, and the shutter operates after 2 seconds.

 **Self-timer(Cont.): 2 Sec. 5 Img.:**

Shoots five frames in succession 2 seconds after you press the shutter button. When you press the shutter button, the self-timer lamp flashes, a beep sounds, and the shutter operates after 2 seconds.

Hint

- To cancel the self-timer, select MENU →  (Camera Settings) → [Drive Mode] → [Single Shooting].

[98] How to Use | Using shooting functions | Selecting a drive mode (Continuous shooting/Self-timer)

Cont. Bracket

Shoots multiple images while automatically shifting the exposure from base to darker and then to lighter. Press and hold down the shutter button until the bracket recording is completed.

You can select an image that suits your intention, after recording.

1. MENU →  (Camera Settings) → [Drive Mode] → [Cont. Bracket].
2. Select the desired mode using the right/left side of the control wheel.

Menu item details

 **Cont. Bracket: 0.3EV 3 Image:**

This setting shoots three images continuously with an exposure value shifted by plus or minus 0.3 EV.

 **Cont. Bracket: 0.3EV 5 Image:**

This setting shoots five images continuously with an exposure value shifted by plus or minus 0.3 EV.

 **Cont. Bracket: 0.3EV 9 Image:**

This setting shoots nine images continuously with an exposure value shifted by plus or minus 0.3 EV.

 Cont. Bracket: 0.7EV 3 Image:

This setting shoots three images continuously with an exposure value shifted by plus or minus 0.7 EV.

 Cont. Bracket: 0.7EV 5 Image:

This setting shoots five images continuously with an exposure value shifted by plus or minus 0.7 EV.

 Cont. Bracket: 0.7EV 9 Image:

This setting shoots nine images continuously with an exposure value shifted by plus or minus 0.7 EV.

 Cont. Bracket: 1.0EV 3 Image:

This setting shoots three images continuously with an exposure value shifted by plus or minus 1.0 EV.

 Cont. Bracket: 1.0EV 5 Image:

This setting shoots five images continuously with an exposure value shifted by plus or minus 1.0 EV.

 Cont. Bracket: 1.0EV 9 Image:

This setting shoots nine images continuously with an exposure value shifted by plus or minus 1.0 EV.

 Cont. Bracket: 2.0EV 3 Image:

This setting shoots three images continuously with an exposure value shifted by plus or minus 2.0 EV.

 Cont. Bracket: 2.0EV 5 Image:

This setting shoots five images continuously with an exposure value shifted by plus or minus 2.0 EV.

 Cont. Bracket: 3.0EV 3 Image:

This setting shoots three images continuously with an exposure value shifted by plus or minus 3.0 EV.

 Cont. Bracket: 3.0EV 5 Image:

This setting shoots five images continuously with an exposure value shifted by plus or minus 3.0 EV.

Note

- The last shot is shown on the Auto Review.
- When [ISO AUTO] is selected in [Manual Exposure] mode, the exposure is changed by adjusting the ISO value. If a setting other than [ISO AUTO] is selected, the exposure is changed by adjusting the shutter speed.
- When you adjust the exposure, the exposure is shifted based on the compensated value.
- Bracket shooting is unavailable in the following situations:

- The shooting mode is set to [Intelligent Auto], [Superior Auto], [Scene Selection], or [Sweep Panorama].
- When the flash is used, the product performs flash bracket shooting, which shifts the amount of flash light even if [Cont. Bracket] is selected. Press the shutter button for each image.

[99] How to Use | Using shooting functions | Selecting a drive mode (Continuous shooting/Self-timer)

Single Bracket

Shoots multiple images while automatically shifting the exposure from base to darker and then to lighter. Press the shutter button for each image. You can select an image that suits your purpose after recording.

1. MENU →  (Camera Settings) → [Drive Mode] → [Single Bracket].
2. Select the desired mode using the right/left side of the control wheel.

Menu item details

Single Bracket: 0.3EV 3 Image:

This setting shoots a total of three images in a row with an exposure value shifted by plus or minus 0.3 EV.

Single Bracket: 0.3EV 5 Image:

This setting shoots a total of five images in a row with an exposure value shifted by plus or minus 0.3 EV.

Single Bracket: 0.3EV 9 Image:

This setting shoots a total of nine images in a row with an exposure value shifted by plus or minus 0.3 EV.

Single Bracket: 0.7EV 3 Image:

This setting shoots a total of three images in a row with an exposure value shifted by plus or minus 0.7 EV.

Single Bracket: 0.7EV 5 Image:

This setting shoots a total of five images in a row with an exposure value shifted by plus or minus 0.7 EV.

Single Bracket: 0.7EV 9 Image:

This setting shoots a total of nine images in a row with an exposure value shifted by plus or minus 0.7 EV.

BRK 5 1.0EV3 Single Bracket: 1.0EV 3 Image:

This setting shoots a total of three images in a row with an exposure value shifted by plus or minus 1.0 EV.

BRK 5 1.0EV5 Single Bracket: 1.0EV 5 Image:

This setting shoots a total of five images in a row with an exposure value shifted by plus or minus 1.0 EV.

BRK 5 1.0EV9 Single Bracket: 1.0EV 9 Image:

This setting shoots a total of nine images in a row with an exposure value shifted by plus or minus 1.0 EV.

BRK 5 2.0EV3 Single Bracket: 2.0EV 3 Image:

This setting shoots a total of three images in a row with an exposure value shifted by plus or minus 2.0 EV.

BRK 5 2.0EV5 Single Bracket: 2.0EV 5 Image:

This setting shoots a total of five images in a row with an exposure value shifted by plus or minus 2.0 EV.

BRK 5 3.0EV3 Single Bracket: 3.0EV 3 Image:

This setting shoots a total of three images in a row with an exposure value shifted by plus or minus 3.0 EV.

BRK 5 3.0EV5 Single Bracket: 3.0EV 5 Image:

This setting shoots a total of five images in a row with an exposure value shifted by plus or minus 3.0 EV.

Note

- When [ISO AUTO] is selected in [Manual Exposure] mode, the exposure is changed by adjusting the ISO value. If a setting other than [ISO AUTO] is selected, the exposure is changed by adjusting the shutter speed.
- When you adjust the exposure, the exposure is shifted based on the compensated value.
- Bracket shooting is unavailable in the following situations:
 - The shooting mode is set to [Intelligent Auto], [Superior Auto], [Scene Selection], or [Sweep Panorama].

[100] How to Use | Using shooting functions | Selecting a drive mode (Continuous shooting/Self-timer)

WB bracket

Shoots three images, each with different color tones according to the selected settings of white balance, color temperature and color filter.

1. MENU →  (Camera Settings) → [Drive Mode] → [WB bracket].
2. Select the desired mode using the right/left side of the control wheel.

Menu item details

White Balance Bracket: Lo:

Records a series of three images with small changes in the white balance.

White Balance Bracket: Hi:

Records a series of three images with large changes in the white balance.

Note

- The last shot is shown on the Auto Review.

[101] How to Use | Using shooting functions | Selecting a drive mode (Continuous shooting/Self-timer)

DRO Bracket

You can record a total of three images, each at a different degree of D-Range Optimizer value.

1. MENU →  (Camera Settings) → [Drive Mode] → [DRO Bracket].
2. Select the desired mode using the right/left side of the control wheel.

Menu item details

DRO Bracket: Lo:

Records a series of three images with small changes in the D-Range Optimizer value.

DRO Bracket: Hi:

Records a series of three images with large changes in the D-Range Optimizer value.

Note

- The last shot is shown on the Auto Review.

[102] How to Use | Using shooting functions | Selecting a drive mode (Continuous shooting/Self-timer)

LPF Bracket

Shoots a total of three images with [LPF Effect] set to [Standard], [High], and [Off] for one image each.

1. MENU →  (Camera Settings) → [Drive Mode] → [LPF Bracket].



Note

- The shooting order used by [LPF Bracket] cannot be changed.
- When using a flash (sold separately) to shoot in the [LPF Bracket] mode, press the shutter button for each image.

[103] How to Use | Using shooting functions | Selecting a drive mode (Continuous shooting/Self-timer)

Settings for bracket shooting

You can set the self-timer in bracket shooting mode, and the shooting order for exposure bracketing and white balance bracketing.

1. MENU →  (Camera Settings) → [Drive Mode] → select bracket shooting mode.
2. MENU →  (Camera Settings) → [Bracket Settings] → desired setting.

Menu item details

Selftimer during Brkt:

Sets whether to use the self-timer during bracket shooting. Also sets the number of seconds until the shutter is released if using the self-timer.

(OFF/2 Sec/5 Sec/10 Sec)

Bracket order:

Sets the order of exposure bracketing and white balance bracketing.

(0→-→+/-→0→+)

Note

- The shooting order used by [LPF Bracket] cannot be changed.
-

Indicator during bracket shooting

Viewfinder

Ambient light* bracketing

3 images shifted by 0.3 EV steps

Exposure compensation ± 0.0 steps



Monitor (Display All Info. or Histogram)

Ambient light* bracketing

3 images shifted by 0.3 EV steps

Exposure compensation ± 0.0 steps



Flash bracketing

3 images shifted by 0.7 EV steps

Flash compensation -1.0 step

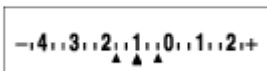

Monitor (For viewfinder)

Ambient light* bracketing

3 images shifted by 0.3 EV steps

Exposure compensation ± 0.0 steps

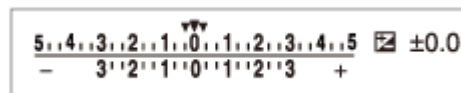

Flash bracketing

3 images shifted by 0.7 EV steps

Flash compensation -1.0 step



* Ambient light: A generic term for non-flash light including natural light, electric bulb and fluorescent lighting. Whereas the flash light blinks for a moment, ambient light is constant, so this kind of light is called "ambient light."

Note

- During bracket shooting, guides equal to the number of images to be shot are displayed over/under the bracket indicator.
- When you start bracket shooting, the guides will disappear one by one as the camera records images.

[105] How to Use | Using shooting functions | Selecting the ISO sensitivity

ISO

Sensitivity to light is expressed by the ISO number (recommended exposure index). The larger the number, the higher the sensitivity.

1. MENU →  (Camera Settings) → [ISO] → desired setting.

Menu item details

Multi Frame NR:

Combines continuous shots to create an image with less noise. Select the desired ISO number from [ISO AUTO] or ISO 100 – 102400.

ISO AUTO:

Sets the ISO sensitivity automatically.

ISO 50 – ISO 102400:

Sets the ISO sensitivity manually. Selecting a larger number increases the ISO sensitivity.

Note

- [ISO AUTO] is selected when using the following functions:
 - [Intelligent Auto]
 - [Superior Auto]
 - [Scene Selection]
 - [Sweep Panorama]
- When [ISO] is set to a value lower than ISO 100, the range for recordable subject brightness (dynamic range) may decrease.
- The higher the ISO value, the more noise will appear on the images.
- When shooting movies, ISO values between ISO 100 and ISO 25600 are available. If the ISO value is set to a value smaller than ISO 100, the setting is automatically switched to

ISO 100. When you finish recording the movie, the ISO value returns to the original setting.

- When you use [Multi Frame NR], it takes some time for the product to perform the overlay processing of images.

Hint

- You can change the automatically set ISO sensitivity range for the [ISO AUTO] mode. Select [ISO AUTO] and press the right side of the control wheel, and set the desired values for [ISO AUTO Maximum] and [ISO AUTO Minimum]. The values for [ISO AUTO Maximum] and [ISO AUTO Minimum] are also applied when shooting in [ISO AUTO] mode under [Multi Frame NR].

[106] How to Use | Using shooting functions | Selecting the ISO sensitivity

ISO AUTO Min. SS

If you select [ISO AUTO] or [ISO AUTO] under [Multi Frame NR] when the shooting mode is P (Program Auto) or A (Aperture Priority), you can set the shutter speed at which the ISO sensitivity starts changing.

This function is effective for shooting moving subjects. You can minimize subject blurring while also preventing camera shake.

1. MENU →  (Camera Settings) → [ISO AUTO Min. SS] → desired setting.

Menu item details

FASTER (Faster)/FAST (Fast):

The ISO sensitivity will start to change at shutter speeds faster than [Standard], so you can prevent camera shake and subject blurring.

STD (Standard):

The camera automatically sets the shutter speed based on the focal length of the lens.

SLOW (Slow)/SLOWER (Slower):

The ISO sensitivity will start to change at shutter speeds slower than [Standard], so you can shoot images with less noise.

1/4000–30":

The ISO sensitivity starts to change at the shutter speed you have set.

Hint

- The difference in shutter speed at which ISO sensitivity starts to change between [Faster], [Fast], [Standard], [Slow], and [Slower] is 1 EV.

Note

- If the exposure is insufficient even when the ISO sensitivity is set to [ISO AUTO Maximum] in [ISO AUTO], in order to shoot with an appropriate exposure, the shutter speed will be slower than the speed set in [ISO AUTO Min. SS].
- In the following situations, the shutter speed may not function as set:
 - When the maximum shutter speed has changed based on the aperture.
 - When using the flash to shoot dark scenes with the [Flash Mode] set to [Fill-flash] or [Wireless]. (The minimum shutter speed is limited to the speed automatically determined by the camera.)

[107] How to Use | Using shooting functions | Selecting the ISO sensitivity

Multi Frame NR

The product automatically shoots multiple images continuously, combines them, reduces the noise, and records them as one image. The image recorded is one combined image.

1. MENU →  (Camera Settings) → [ISO] → [Multi Frame NR].
2. Press the right side of the control wheel to display the setting screen, then select a desired value using the top/bottom side of the control wheel.

Note

- When [ Quality] is set to [RAW] or [RAW & JPEG], this function cannot be used.
- The flash, [D-Range Opt.], and [Auto HDR] cannot be used.
- When [Picture Effect] is set to something other than [Off], you cannot set [Multi Frame NR].

Hint

- You can change the automatically set range of ISO sensitivity in the [ISO AUTO] mode under [Multi Frame NR]. Select [ISO AUTO] under [ISO] and press the right side of the control wheel, and set the desired values for [ISO AUTO Maximum] and [ISO AUTO Minimum]. The values for [ISO AUTO Maximum] and [ISO AUTO Minimum] are also applied when shooting in [ISO AUTO] mode under [Multi Frame NR].

[108] How to Use | Using shooting functions | Correcting the brightness or contrast

D-Range Opt. (DRO)

By dividing the image into small areas, the product analyzes the contrast of light and shadow between the subject and the background, and creates an image with the optimal brightness and gradation.

1. MENU →  (Camera Settings) → [DRO/Auto HDR] → [D-Range Opt.].
2. Select the desired setting using the left/right side of the control wheel.

Menu item details

D-Range Optimizer: Auto:

Corrects the brightness automatically.

D-Range Optimizer: Lv1 – D-Range Optimizer: Lv5:

Optimizes the gradation of a recorded image for each divided area. Select the optimization level from Lv1 (weak) to Lv5 (strong).

Note

- [DRO/Auto HDR] is fixed to [Off] when the shooting mode is set to [Sweep Panorama], or when [Multi Frame NR] or [Picture Effect] is set to other than [Off].
- [DRO/Auto HDR] is fixed to [Off] when the following modes are selected in [Scene Selection].
 - [Sunset]
 - [Night Scene]
 - [Night Portrait]
 - [Hand-held Twilight]
 - [Anti Motion Blur]

The setting is fixed to [D-Range Optimizer: Auto] when [Scene Selection] modes other than the above modes are selected.

- When shooting with [D-Range Opt.], the image may be noisy. Select the proper level by checking the recorded image, especially when you enhance the effect.

[109] How to Use | Using shooting functions | Correcting the brightness or contrast Auto HDR

Widens the range (gradation) so that you can record from bright parts to dark parts with correct brightness (HDR: High Dynamic Range). One image with proper exposure and one overlaid image are recorded.

1. MENU →  (Camera Settings) → [DRO/Auto HDR] → [Auto HDR].

2. Select the desired setting using the left/right side of the control wheel.

Menu item details



Auto HDR: Exposure Diff. Auto:

Corrects the exposure difference automatically.



Auto HDR: Exposure Diff. 1.0EV – Auto HDR: Exposure Diff. 6.0EV:

Sets the exposure difference, based on the contrast of the subject. Select the optimal level between 1.0 EV (weak) and 6.0 EV (strong).

For example, if you set the exposure value to 2.0 EV, three images will be composed with the following exposure levels: -1.0 EV, correct exposure and +1.0 EV.

Note

- [Auto HDR] is not available for RAW images.
- [Auto HDR] is not available in the following shooting modes.
 - [Intelligent Auto]
 - [Superior Auto]
 - [Sweep Panorama]
 - [Scene Selection]
- When [Multi Frame NR] is selected, you cannot select [Auto HDR].
- When [Picture Effect] is set to something other than [Off], you cannot select [Auto HDR].
- You cannot start the next shot until the capture process is completed after you shoot.
- You may not obtain the desired effect depending on the luminance difference of a subject and the shooting conditions.
- When the flash is used, this function has little effect.
- When the contrast of the scene is low or when product shake or subject blur occurs, you may not obtain good HDR images. **HDR !** will be displayed over the recorded image to inform you when the camera detects image blurring. Change the composition or re-shoot the image carefully to avoid image blur, as needed.

[110] How to Use | Using shooting functions | Adjusting color tones

White Balance

Adjusts the color tones according to the ambient light conditions. Use this feature when the color tones of the image did not come out as you expected, or when you want to change the color tones on purpose for photographic expression.

1. MENU →  (Camera Settings) → [White Balance] → desired setting.

Menu item details

AWB Auto:

The product automatically detects the light source and adjusts the color tones.

Daylight:

The color tones are adjusted for the daylight.

Shade:

The color tones are adjusted for shadiness.

Cloudy:

The color temperature is adjusted for a cloudy sky.

Incandescent:

The color temperature is adjusted for places under an incandescent lamp, or under bright lighting, such as in a photo studio.

-1 Fluor.: Warm White:

The color temperature is adjusted for warm white fluorescent lighting.

0 Fluor.: Cool White:

The color temperature is adjusted for white fluorescent lighting.

+1 Fluor.: Day White:

The color temperature is adjusted for neutral white fluorescent lighting.

+2 Fluor.: Daylight:

The color temperature is adjusted for daylight fluorescent lighting.

Flash:

The color temperature is adjusted for flash light.

C.Temp./Filter:

Adjusts the color tones depending on the light source. Achieves the effect of CC (Color Compensation) filters for photography.

Custom 1/Custom 2/Custom 3:

Uses the white balance setting saved in [Custom Setup].

SET Custom Setup:

Memorizes the basic white color under the light conditions for the shooting environment. Select a memorized custom white balance number.

Hint

- You can use the right side of the control wheel to display the fine adjustment screen and perform fine adjustments of the color tones as required.
- In [C.Temp./Filter], you can use the right button to display the color temperature setting screen and perform a setting. When you press the right button again, the fine adjustment screen appears to allow you perform fine adjustments as required.



Note

-
- [White Balance] is fixed to [Auto] in the following situations:
 - [Intelligent Auto]
 - [Superior Auto]
 - [Scene Selection]

[111] How to Use | Using shooting functions | Adjusting color tones

Capturing a basic white color in [Custom Setup] mode

In a scene where the ambient light consists of multiple types of light sources, it is recommended to use the custom white balance in order to accurately reproduce the whiteness.

1. MENU →  (Camera Settings) → [White Balance] → [Custom Setup].
2. Hold the product so that the white area fully covers the AF area located in the center, and then press  on the center of the control wheel.
The calibrated values (Color Temperature and Color Filter) are displayed.
3. Select a registration number using the right/left button.
The monitor returns to the recording information display while retaining the memorized custom white balance setting.

Note

- The message [Custom WB Error] indicates that the value is higher than the expected range, when the flash is used on a subject with too bright colors in the frame. If you register this value, the  indicator turns orange on the recording information display. You can shoot at this point, but it is recommended that you set the white balance again to get a more accurate white balance value.

[112] How to Use | Using shooting functions | Selecting an effect mode

Picture Effect

Select the desired effect filter to achieve more impressive and artistic images.

1. MENU →  (Camera Settings) → [Picture Effect] → desired setting.

Menu item details

Off:

Disables the [Picture Effect] function.

Toy Camera:

Creates a soft image with shaded corners and reduced sharpness.

Pop Color:

Creates a vivid look by emphasizing color tones.

Posterization:

Creates a high contrast, abstract look by heavily emphasizing primary colors, or in black and white.

Retro Photo:

Creates the look of an aged photo with sepia color tones and faded contrast.

Soft High-key:

Creates an image with the indicated atmosphere: bright, transparent, ethereal, tender, soft.

Partial Color:

Creates an image which retains a specific color, but converts others to black and white.

High Contrast Mono.:

Creates a high-contrast image in black and white.

Soft Focus:

Creates an image filled with a soft lighting effect.

HDR Painting:

Creates the look of a painting, enhancing the colors and details.

Rich-tone Mono.:

Creates an image in black and white with rich gradation and reproduction of details.

Miniature:

Creates an image which enhances the subject vividly, with the background defocused considerably. This effect may often be found in pictures of miniature models.

Watercolor:

Creates an image with ink bleed and blurring effects as if painted using watercolors.

Illustration:

Creates an illustration-like image by emphasizing the outlines.



Hint

- You can perform detailed settings for the following [Picture Effect] modes using the left/right side of the control wheel.
 - [Toy Camera]

- [Posterization]
- [Partial Color]
- [Soft Focus]
- [HDR Painting]
- [Miniature]
- [Illustration]

Note

- When you use the zoom function, setting a larger zoom scale makes [Toy Camera] less effective.
- When [Partial Color] is selected, images may not retain the selected color, depending on the subject or shooting conditions.
- You cannot check the following effects on the shooting screen, because the product processes the image after the shot. Also, you cannot shoot another image until image processing is finished. You cannot use these effects with movies.
 - [Soft Focus]
 - [HDR Painting]
 - [Rich-tone Mono.]
 - [Miniature]
 - [Watercolor]
 - [Illustration]
- In the case of [HDR Painting] and [Rich-tone Mono.], the shutter is released three times for one shot. Be careful about the following:
 - Use this function when the subject is motionless or does not flash light.
 - Do not change the composition before shooting.

When the contrast of the scene is low or when significant camera-shake or subject blur has occurred, you may not be able to obtain good HDR images. If the product detects such a situation,  /  appear on the recorded image to inform you of this situation. If necessary, change the composition or otherwise adjust the settings, be careful of blurring, and shoot again.

- [Picture Effect] cannot be set when the shooting mode is set to [Intelligent Auto], [Superior Auto], [Scene Selection] or [Sweep Panorama].
- [Picture Effect] cannot be set when [ Quality] is set to [RAW] or [RAW & JPEG].

[113] How to Use | Using shooting functions | Selecting an effect mode

Creative Style

Allows you to select the desired image processing. You can adjust exposure (shutter speed and aperture) as you like with [Creative Style], unlike with [Scene Selection] where the product adjusts the exposure.

1. MENU →  (Camera Settings) → [Creative Style] → desired setting.

Menu item details

Standard:

For shooting various scenes with rich gradation and beautiful colors.

Vivid:

The saturation and contrast are heightened for shooting striking images of colorful scenes and subjects such as flowers, spring greenery, blue sky, or ocean views.

Neutral:

The saturation and sharpness are lowered for shooting images in subdued tones. This is also suitable for capturing image material to be modified with a computer.

Clear:

For shooting images in clear tones with limpid colors in highlight, suitable for capturing radiant light.

Deep:

For shooting images with deep and dense colors, suitable for capturing the solid presence of the subject.

Light:

For shooting images with bright and simple colors, suitable for capturing a refreshingly light ambience.

Portrait:

For capturing skin in a soft tone, ideally suited for shooting portraits.

Landscape:

The saturation, contrast, and sharpness are heightened for shooting vivid and crisp scenery. Distant landscapes also stand out more.

Sunset:

For shooting the beautiful red of the setting sun.

Night Scene:

The contrast is lowered for reproducing night scenes.

Autumn leaves:

For shooting autumn scenes, vividly highlighting the reds and yellows of changing leaves.

Black & White:

For shooting images in black and white monotone.

Sepia:

For shooting images in sepia monotone.

Registering preferred settings (Style Box):

Select the six style box (the boxes with numbers on the left side ()) to register preferred settings. Then select the desired settings using the right button.

You can call up the same style with slightly different settings.

To set **[Contrast]**, **[Saturation]** and **[Sharpness]**

[Contrast], [Saturation] and [Sharpness] can be adjusted for each [Style Box] item.

Select an item to be set by pressing the right/left side of the control wheel, then set the value using the top/bottom side of the control wheel.

Contrast:

The higher the value selected, the more the difference of light and shadow is accentuated, and the bigger the effect on the image.

Saturation:

The higher the value selected, the more vivid the color. When a lower value is selected, the color of the image is restrained and subdued.

Sharpness:

Adjusts the sharpness. The higher the value selected, the more the contours are accentuated, and the lower the value selected, the more the contours are softened.

Note

- [Standard] is selected when using the following functions:
 - [Intelligent Auto]
 - [Superior Auto]
 - [Scene Selection]
 - [Picture Effect] is set to other than [Off].
- When [Creative Style] is set to [Black & White] or [Sepia], [Saturation] cannot be adjusted.

[114] How to Use | Using shooting functions | Recording movies

Movie recording formats

The following movie recording formats are available with this camera.

What is XAVC S?

Records high-definition movies by converting them to MP4 movies using the MPEG-4 AVC/H.264 codec. MPEG-4 AVC/H.264 is capable of compressing images at higher efficiency. You can record high-quality images while reducing the amount of data.

XAVC S/AVCHD recording format

XAVC S HD:

Bit-rate: Approx. 50 Mbps

Records a more vivid movie compared to AVCHD with increased amounts of information.

AVCHD:

Bit-rate: Approx. 28 Mbps (Maximum), Approx. 24 Mbps (Maximum) or Approx. 17 Mbps (Average)



The AVCHD format has a high degree of compatibility with storage devices other than computers.

- Bit rate is the amount of the data processed within a given length of time.

[115] How to Use | Using shooting functions | Recording movies

File Format (movie)

Selects the movie file format.



1. MENU →  (Camera Settings) → [ File Format] → desired setting.

Menu item details

XAVC S HD:

Records high-definition movies in XAVC S HD. This format supports a higher bit rate.

Audio: LPCM

- In order to record movies with [ File Format] set to [XAVC S HD], the following kind of memory card is needed:
 - SDXC memory card with a capacity of 64 GB or more (SD Speed Class 10 ())
 - UHS-I compatible SDXC memory card with a capacity of 64 GB or more (UHS Speed Class 1 ()) or faster)

AVCHD:

Records HD movies in AVCHD format. This file format is suitable for high-definition TV.

Audio: Dolby Digital

MP4:

Records mp4 (AVC) movies. This format is suitable for playback on smartphones or tablets, web uploads, email attachments, etc.

Audio: AAC



Hint

- You can save images on a computer or copy them to a compatible medium using the software PlayMemories Home.

Note

- The continuous recording duration for XAVC S HD 120p/100p movies is approximately 5 minutes. If you finish recording a XAVC S HD 120p/100p movie and want to record



another, turn the power off for several minutes before turning it back on and resuming recording. Even if the recording duration is less than 5 minutes, depending on the temperature of the recording environment, the power may turn off to protect the product.

- When [ File Format] is set to [AVCHD], the file size of movies is limited to approx. 2 GB. If the movie file size reaches approx. 2 GB during recording, a new movie file will be created automatically.
- When [ File Format] is set to [MP4], the file size of movies is limited to approx. 4 GB. If the movie file size reaches approx. 4 GB during recording, recording will stop automatically.

[116] How to Use | Using shooting functions | Recording movies

Record Setting (movie)

Selects the image size, frame rate, and image quality for movie recording. The higher the bit-rate, the higher the image quality.

1. MENU →  (Camera Settings) → [ Record Setting] → desired setting.

When [File Format] is set to [XAVC S HD]

Records high-definition movies by converting them to MP4 file format using the MPEG-4 AVC/H.264 codec.

When [File Format] is set to [AVCHD]

60i/50i: Movies are recorded at approximately 60 fields/sec (for 1080 60i-compatible devices) or 50 fields/sec (for 1080 50i-compatible devices), in interlaced mode, with Dolby Digital audio, in AVCHD format.

24p/25p: Movies are recorded at approximately 24 frames/sec (for 1080 60i-compatible devices) or 25 frames/sec (for 1080 50i-compatible devices), in progressive mode, with Dolby Digital audio, in AVCHD format.

60p/50p: Movies are recorded at approximately 60 frames/sec (for 1080 60i-compatible devices) or 50 frames/sec (for 1080 50i-compatible devices), in progressive mode, with Dolby Digital audio, in AVCHD format.

When [File Format] is set to [MP4]

Movies shot are recorded in MPEG-4 format, at approximately 60 frames/sec (for 1080 60i-compatible devices), approximately 50 frames/sec (for 1080 50i-compatible devices), approximately 30 frames/sec (for 1080 60i-compatible devices) or approximately 25 frames/sec (for 1080 50i-compatible devices), in progressive mode, with AAC audio, MP4 format.

Menu item details

When [File Format] is set to [XAVC S HD]

60p 50M/50p 50M:

Records the movies in 1920 × 1080 (60p/50p).

Bit-rate: Approx. 50 Mbps

30p 50M/25p 50M:

Records the movies in 1920 × 1080 (30p/25p).

Bit-rate: Approx. 50 Mbps

24p 50M*:

Records the movies in 1920 × 1080 (24p). This produces a cinema-like atmosphere.

Bit-rate: Approx. 50 Mbps

120p 50M/100p 50M:

Records 1280 × 720 (120p/100p) size movies at a high speed. Movies can be recorded at 120 fps/100 fps.

You can create smoother slow-motion images using compatible editing equipment.

Bit-rate: Approx. 50 Mbps

When [File Format] is set to [AVCHD]

60i 24M(FX)/50i 24M(FX):

Records the movies in 1920 × 1080 (60i/50i).

Bit-rate: 24 Mbps (Max.)

60i 17M(FH)/50i 17M(FH):

Records the movies in 1920 × 1080 (60i/50i).

Bit-rate: Approx. 17 Mbps (Avg.)

60p 28M(PS)/50p 28M(PS):

Records the movies in 1920 × 1080 (60p/50p).

Bit-rate: 28 Mbps (Max.)

24p 24M(FX)/25p 24M(FX):

Records the movies in 1920 × 1080 (24p/25p). This produces a cinema-like atmosphere.

Bit-rate: 24 Mbps (Max.)

24p 17M(FH)/25p 17M(FH):

Records the movies in 1920 × 1080 (24p/25p). This produces a cinema-like atmosphere.

Bit-rate: Approx. 17 Mbps (Avg.)

When [File Format] is set to [MP4]

1920x1080 60p 28M/1920x1080 50p 28M:

Records the movies in 1920x1080 (60p/50p).

Bit-rate: Approx. 28 Mbps (Avg.)

1920x1080 30p 16M/1920x1080 25p 16M:

Records the movies in 1920×1080 (30p/25p).

Bit-rate: Approx. 16 Mbps (Avg.)

1280x720 30p 6M/1280x720 25p 6M:

Records small file size movies in 1280×720 (30p/25p).

Bit-rate: Approx. 6 Mbps (Avg.)

* Only when [NTSC/PAL Selector] is set to NTSC.

([NTSC/PAL Selector] is only available for models that have AVCHD 50i recording as a default setting.)

Note

- 60p/50p movies can be played back only on compatible devices.
- Movies recorded with the [60p 28M(PS)]/[50p 28M(PS)]/[60i 24M(FX)]/[50i 24M(FX)]/[24p 24M(FX)]/[25p 24M(FX)] setting in [ Record Setting] are converted by PlayMemories Home in order to create an AVCHD recording disc. This conversion can take a long time. Also, you cannot create a disc in the original image quality. If you want to keep the original image quality, store your movies on a Blu-ray Disc.
- To play back 60p/50p/24p/25p movies on a TV, the TV must be compatible with the 60p/50p/24p/25p formats. If the TV is not compatible with the 60p/50p/24p/25p format, 60p/50p/24p/25p movies will be output as 60i/50i movies.
- [120p]/[100p] cannot be selected for the following settings.
 - [Intelligent Auto]
 - [Superior Auto]
 - [Scene Selection]

[117] How to Use | Using shooting functions | Recording movies

Dual Video REC

Allows you to simultaneously record an XAVC S movie and an MP4 movie, or an AVCHD movie and an MP4 movie.

1. MENU →  (Camera Settings) → [Dual Video REC] → desired setting.

Menu item details



On:

An XAVC S movie and an MP4 movie, or an AVCHD movie and an MP4 movie, are recorded simultaneously.

Off:

The [Dual Video REC] function is not used.



Note

- When [ Record Setting] for an XAVC S movie is set to [60p]/[50p] or [120p]/[100p], [ Record Setting] for an AVCHD movie is set to [60p]/[50p], or [ File Format] is set to [MP4], the [Dual Video REC] function is set to [Off].
- If you select [Date View] in [View Mode] when playing back movies, XAVC S movies and MP4 movies, or AVCHD movies and MP4 movies are displayed side-by-side.

[118] How to Use | Using shooting functions | Recording movies

Marker Display (movie)

Sets whether or not to display markers set using [ Marker Settings] on the monitor while shooting movies.

1. MENU →  (Custom Settings) → [ Marker Display] → desired setting.

Menu item details

On:

Markers are displayed. The markers are not recorded.

Off:

No marker is displayed.



Note

- The markers are displayed when the mode dial is set to  (Movie) or when shooting movies.
- You cannot display markers when using [Focus Magnifier].
- The markers are displayed on the monitor or viewfinder. (You cannot output the markers.)

[119] How to Use | Using shooting functions | Recording movies

Marker Settings (movie)

Sets the markers to be displayed while shooting movies.

1. MENU →  (Custom Settings) → [ Marker Settings] → desired setting.

Menu item details

Center:

Sets whether or not to display the center marker in the center of the shooting screen.

Off / On

Aspect:

Sets the aspect marker display.

Off / 4:3 / 13:9 / 14:9 / 15:9 / 1.66:1 / 1.85:1 / 2.35:1

Safety Zone:

Sets the safety zone display. This becomes the standard range that can be received by a general household TV.

Off / 80% / 90%

Guideframe:

Sets whether or not to display the guide frame. You can verify whether the subject is level or perpendicular to the ground.



Off / On



Hint

- You can display all the markers at the same time.
- Place the subject on the cross point of the [Guideframe] to make a balanced composition.

[120] How to Use | Using shooting functions | Recording movies

SteadyShot (movie)

Sets [ SteadyShot] effect when shooting movies. If you set the [ SteadyShot] effect to [Off] when using a tripod (sold separately), a natural image is produced.

1. MENU →  (Camera Settings) → [ SteadyShot] → desired setting.

Menu item details

On:

Uses [ SteadyShot].

Off:

Does not use [ SteadyShot].

Note

- If you change the setting for [ SteadyShot], the angle of view will change.

[121] How to Use | Using shooting functions | Recording movies

Audio Recording

Sets whether to record sounds when shooting movies.

1. MENU →  (Camera Settings) → [Audio Recording] → desired setting.

Menu item details

On:

Records sound (stereo).

Off:

Does not record sound.

Note

- The noise of the lens and the product in operation will also be recorded, when [On] is selected.

[122] How to Use | Using shooting functions | Recording movies

Audio Level Display

Sets whether to display the audio level on the screen.

1. MENU →  (Custom Settings) → [Audio Level Display] → desired setting.

Menu item details

On:

Displays the audio level.

Off:

Does not display the audio level.

Note

- The audio level is not displayed in the following situations:
 - When [Audio Recording] is set to [Off].

- - When DISP (Display Setting) is set to [No Disp. Info.].
- Set the shooting mode to Movie. You can see the audio level before recording only in movie recording mode.

[123] How to Use | Using shooting functions | Recording movies

Audio Rec Level

You can adjust the audio recording level while checking the level meter.

1. MENU →  (Camera Settings) → [Audio Rec Level] → desired setting.

Menu item details

+:

Turns up the audio recording level.

-:

Turns down the audio recording level.

Reset:

Resets the audio recording level to the default setting.

Hint

- When you record audio movies with loud volumes, set [Audio Rec Level] to a lower sound level. Doing so enables you to record more realistic audio. When you record audio movies with lower volumes, set [Audio Rec Level] to a greater sound level to make the sound easier to hear.

Note

- Regardless of the [Audio Rec Level] settings, the limiter always operates.
- [Audio Rec Level] is available only when the shooting mode is set to Movie.
- The [Audio Rec Level] settings are applied for both the internal microphone and the  (Microphone) terminal input.

[124] How to Use | Using shooting functions | Recording movies

Wind Noise Reduct.

Sets whether or not to reduce wind noise during movie recording.

1. MENU →  (Camera Settings) → [Wind Noise Reduct.] → desired setting.

Menu item details

On:

Reduces wind noise.

Off:

Does not reduce wind noise.



Note

- Setting this item to [On] where wind is not blowing sufficiently hard may cause normal sound to be recorded with too low volume.
- When an external microphone (sold separately) is used, [Wind Noise Reduct.] does not function.

[125] How to Use | Using shooting functions | Recording movies

Auto Slow Shut. (movie)

Sets whether or not to adjust the shutter speed automatically when recording movies if the subject is dark.

1. MENU →  (Camera Settings) → [ Auto Slow Shut.] → desired setting.

Menu item details



On:

Uses [ Auto Slow Shut.]. The shutter speed automatically slows when recording in dark locations. You can reduce noise in the movie by using a slow shutter speed when recording in dark locations.

Off:

Does not use [ Auto Slow Shut.]. The recorded movie will be darker than when [On] is selected, but you can record movies with smoother motion and less object blur.

Note

- [ Auto Slow Shut.] does not function in the following situations:
 -  (Shutter Priority)
 -  (Manual Exposure)
 - When [ISO] is set to other than [ISO AUTO].

MOVIE Button

Sets whether or not to activate the MOVIE button.

1. MENU →  (Custom Settings) → [MOVIE Button] → desired setting.

Menu item details

Always:

Starts movie recording when you press the MOVIE button in any mode.

Movie Mode Only:

Starts movie recording when you press the MOVIE button only if the shooting mode is set to [Movie] mode.

Memory

Allows you to register up to 3 often-used modes or product settings in the product. You can recall the settings using just the mode dial.

1. Set the product to the setting you want to register.
2. MENU →  (Camera Settings) → [Memory] → desired number.

Items that can be registered

- Shooting mode
- Shutter speed
-  Camera Settings

To recall registered settings

Select the memory number from “1,” “2” or “3” on the mode dial.

To change registered settings

Change the setting to the desired one and re-register the setting to the same mode number.

Note

- Program Shift cannot be registered.
- For some functions, the position of the dial and the setting actually used for shooting may not match. If this happens, shoot images by referring to the information displayed on the monitor.

[128] How to Use | Using shooting functions | Customizing the shooting functions for convenient use

Function Menu Set.

You can assign the functions to be called up when you press the Fn (Function) button.

1. MENU →  (Custom Settings) → [Function Menu Set.] → set a function to the desired location.

The functions that can be assigned are displayed on the setup item selection screen.

[129] How to Use | Using shooting functions | Customizing the shooting functions for convenient use

Custom Key(Shoot.) / Custom Key(PB)

Assigning functions to the various keys allows you to speed up operations by pressing the appropriate key when the shooting information screen or playback screen is displayed to execute an assigned function.

1. MENU →  (Custom Settings) → [Custom Key(Shoot.)] / [Custom Key(PB)] → set a function to the desired key.

Examples of functions that can only be assigned with custom keys

Standard:

Depending on the options selected in [Focus Area] or [Center Lock-on AF], the available functions varies when pressing the key.

- When you press the key when the [Focus Area] is set to [Flexible Spot] or [Expand Flexible Spot], you can change the focus area position.
- When you press the key when the [Focus Area] is set to [Wide] or [Center] and [Center

Lock-on AF] is [On], [Center Lock-on AF] will activate.

Note

- You can assign two functions to the same key to have different functions for shooting and playback.
- In [Custom Key(PB)], fewer buttons can be assigned a function than in [Custom Key(Shoot.)].
- Some functions cannot be assigned to certain keys.

[130] How to Use | Using shooting functions | Customizing the shooting functions for convenient use

Function of the control wheel

Once you assign a function to the control wheel, you can perform that function by simply turning the wheel when the shooting information screen is displayed.

1. MENU →  (Custom Settings) → [Custom Key(Shoot.)] → [Control Wheel] → desired setting.

The functions that can be assigned are displayed on the setup item selection screen.

[131] How to Use | Using shooting functions | Customizing the shooting functions for convenient use

Function of the AEL button

Once you assign a function to the AEL button, you can perform that function by simply pressing the AEL button when the shooting information screen is displayed.

1. MENU →  (Custom Settings) → [Custom Key(Shoot.)] → [AEL Button] → desired setting.

The functions that can be assigned are displayed on the setup item selection screen.

[132] How to Use | Using shooting functions | Customizing the shooting functions for

convenient use

Function of the Custom button

Once you assign a function to the Custom button, you can perform that function by simply pressing the Custom button when the shooting information screen or playback screen is displayed.

1. MENU →  (Custom Settings) → [Custom Key(Shoot.)] or [Custom Key(PB)] → [Custom Button 1] or [Custom Button 2] → desired setting.
 - The only key that can be assigned a function with [Custom Key(PB)] is [Custom Button 1].

The functions that can be assigned are displayed on the setup item selection screen.

Hint

- If you select MENU →  (Custom Settings) → [Custom Key(PB)] → [Custom Button 1] → [Follow Custom(Sht.)], the function selected for [Custom Key(Shoot.)] is also assigned to that key in playback mode.

[133] How to Use | Using shooting functions | Customizing the shooting functions for convenient use

Function of the Center button

Once you assign a function to the center button, you can perform that function by simply pressing the center button when the shooting information screen is displayed.

1. MENU →  (Custom Settings) → [Custom Key(Shoot.)] → [Center Button] → desired setting.

The functions that can be assigned are displayed on the setup item selection screen.

[134] How to Use | Using shooting functions | Customizing the shooting functions for convenient use

Function of the Left button

Once you assign a function to the left button, you can perform that function by simply pressing the left button when the shooting information screen is displayed.

1. MENU →  (Custom Settings) → [Custom Key(Shoot.)] → [Left Button] → desired setting.

The functions that can be assigned are displayed on the setup item selection screen.

[135] How to Use | Using shooting functions | Customizing the shooting functions for convenient use

Function of the Right button

Once you assign a function to the right button, you can perform that function by simply pressing the right button when the shooting information screen is displayed.

1. MENU →  (Custom Settings) → [Custom Key(Shoot.)] → [Right Button] → desired setting.

The functions that can be assigned are displayed on the setup item selection screen.

[136] How to Use | Using shooting functions | Customizing the shooting functions for convenient use

Function of the down button

Once you assign a function to the down button, you can perform that function by simply pressing the down button when the shooting information screen is displayed.

1. MENU →  (Custom Settings) → [Custom Key(Shoot.)] → [Down Button] → desired setting.

The functions that can be assigned are displayed on the setup item selection screen.

[137] How to Use | Using shooting functions | Setting the other functions of this product
Smile/Face Detect.

Detects the faces of your subjects and adjusts the focus, exposure, flash settings and performs image processing automatically.

1. MENU →  (Camera Settings) → [Smile/Face Detect.] → desired setting.

Menu item details

 **Off:**

Does not use the Face Detection function.

 **On (Regist. Faces):**

Detects the registered face with higher priority using [Face Registration].

 **On:**

Detects a face without giving higher priority to the registered face.

 **Smile Shutter:**

Automatically detects and shoots a smile.

Face Detection frame

- When the product detects a face, the gray face detection frame appears. When the product determines that autofocus is enabled, the face detection frame turns white. When you press the shutter button halfway down, the frame turns green.
- In case you have registered the priority order for each face using [Face Registration], the product automatically selects the first prioritized face and the face detection frame over that face turns white. The face detection frames of other registered faces turn reddish-purple.



Tips for capturing smiles more effectively

- Do not cover the eyes with front hair and keep the eyes narrowed.
- Do not obscure the face by a hat, masks, sunglasses, etc.
- Try to orient the face in front of the product and be as level as possible.
- Give a clear smile with an open mouth. The smile is easier to be detected when the teeth are shown.
- If you press the shutter button during Smile Shutter, the product shoots the image. After shooting, the product returns to Smile Shutter mode.

Hint

- When the [Smile/Face Detect.] is set to [Smile Shutter], you can select the Smile Detection Sensitivity from [On: Slight Smile], [On: Normal Smile] and [On: Big Smile].



Note

- You cannot use the Face Detection function with the following functions:
 - Zoom functions
 - [Sweep Panorama]
 - [Picture Effect] is set to [Posterization].
 - When using the [Focus Magnifier] function.
 - [Scene Selection] is set to [Landscape], [Night Scene] or [Sunset].
 - [ Record Setting] is set to [120p]/[100p].
- Up to eight faces of your subjects can be detected.
- The product may not detect faces at all or may accidentally detect other objects as faces in some conditions.
- If the product cannot detect a face, set the Smile Detection Sensitivity.
- If you track a face using [Lock-on AF] while executing Smile Shutter function, Smile Detection is performed only for that face.

[138] How to Use | Using shooting functions | Setting the other functions of this product

Soft Skin Effect (still image)

Sets the effect used for shooting the skin smoothly in the Face Detection function.

1. MENU →  (Camera Settings) → [ Soft Skin Effect] → desired setting.

Menu item details

 **Off:**

Does not use the [ Soft Skin Effect] function.

 **On:**

Uses the [ Soft Skin Effect].

Hint

- When [ Soft Skin Effect] is set to [On], you can select the effect level. Select the effect level by pressing the right/left side of the control wheel.

Note

- [ Soft Skin Effect] is not available when [ Quality] is [RAW].
-

Face Registration (New Registration)

If you register faces in advance, the product can detect the registered face as a priority when [Smile/Face Detect.] is set to [On (Regist. Faces)].

1. MENU →  (Custom Settings) → [Face Registration] → [New Registration].
2. Align the guide frame with the face to be registered, and press the shutter button.
3. When a confirmation message appears, select [Enter].

Note

- Up to eight faces can be registered.
- Shoot the face from the front in a brightly lit place. The face may not be registered correctly if it is obscured by a hat, a mask, sunglasses, etc.

Face Registration (Order Exchanging)

When multiple faces are registered to be given priority, the face registered first will be given priority. You can change the priority order.

1. MENU →  (Custom Settings) → [Face Registration] → [Order Exchanging].
2. Select a face to change the order of priority.
3. Select the destination.

Face Registration (Delete)

Deletes a registered face.

1. MENU →  (Custom Settings) → [Face Registration] → [Delete].

If you select [Delete All], you can delete all registered faces.

Note

- Even if you execute [Delete], the data for registered face will remain in the product. To delete the data for registered faces from the product, select [Delete All].

[142] How to Use | Using shooting functions | Setting the other functions of this product

Red Eye Reduction

When using the flash, it is fired two or more times before shooting to reduce the red-eye phenomenon.

1. MENU →  (Camera Settings) → [Red Eye Reduction] → desired setting.

Menu item details

On:

The flash is always fired to reduce the red-eye phenomenon.

Off:

Does not use Red Eye Reduction.

Note

- Red Eye Reduction may not produce the desired effects. It depends on individual differences and conditions, such as distance to the subject, or whether the subject looks at the pre-strobe or not.

[143] How to Use | Using shooting functions | Setting the other functions of this product

Auto Obj. Framing (still image)

When this product detects and shoots faces, macro shooting subjects or subjects that are tracked by [Lock-on AF], the product automatically trims the image into an appropriate composition, and then saves it. Both the original and the trimmed images are saved. The trimmed image is recorded in the same size as the original image size.

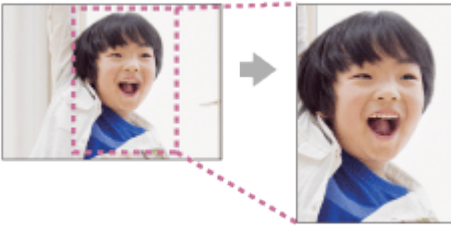

1. MENU →  (Camera Settings) → [ Auto Obj. Framing] → desired setting.

Menu item details



Off:

Does not trim images.

Auto:

Automatically trims images into an appropriate composition.

Note

- The trimmed image may not be the best possible composition, depending on the shooting conditions.
- [ Auto Obj. Framing] cannot be set when [ Quality] is set to [RAW] or [RAW & JPEG].

[144] How to Use | Using shooting functions | Setting the other functions of this product

Long Exposure NR (still image)

When you set the shutter speed to 1 second(s) or longer (long exposure shooting), noise reduction is turned on for the duration that the shutter is open. With the function turned on, the grainy noise typical of long exposures is reduced.

1. MENU →  (Camera Settings) → [ Long Exposure NR] → desired setting.

Menu item details



On:

Activates noise reduction for the same duration that the shutter is open. When noise reduction is in progress, a message appears and you cannot take another picture. Select this to prioritize the image quality.

Off:

Does not activate noise reduction. Select this to prioritize the timing of shooting.



Note

- Noise reduction may not be activated even if [ Long Exposure NR] is set to [On] in the following situations:
 - The shooting mode is set to [Sweep Panorama].
 - [Drive Mode] is set to [Cont. Shooting], [Spd Priority Cont.], [Cont. Bracket] or [LPF Bracket].
 - The shooting mode is set to [Scene Selection] and [Sports Action], [Hand-held Twilight] or [Anti Motion Blur] is selected.
 - The ISO sensitivity is set to [Multi Frame NR].
- You cannot set [ Long Exposure NR] to [Off] when the shooting mode is set to [Intelligent Auto], [Superior Auto] or [Scene Selection].
- Depending on the shooting conditions, the camera may not perform noise reduction, even if the shutter speed is longer than 1 second(s).

[145] How to Use | Using shooting functions | Setting the other functions of this product

High ISO NR (still image)

When shooting with high ISO sensitivity, the product reduces noise that becomes more noticeable when the product sensitivity is high. A message may be displayed during noise reduction processing; you cannot shoot another image until the message disappears.

1. MENU →  (Camera Settings) → [ High ISO NR] → desired setting.

Menu item details

Normal:

Activates high ISO noise reduction normally.



Low:

Activates high ISO noise reduction moderately.

Off:



Does not activate high ISO noise reduction. Select this to prioritize the timing of shooting.

Note

- [ High ISO NR] is not available in the following situations:
 - When the shooting mode is set to [Intelligent Auto], [Superior Auto], [Scene Selection] or [Sweep Panorama].
- [ High ISO NR] is not available for RAW images.

Write Date (still image)

Sets whether to record a shooting date on the still image.

1. MENU →  (Custom Settings) → [ Write Date] → desired setting.

Menu item details

On:

Records a shooting date.

Off:



Does not record a shooting date.

Note

- If you shoot images with the date once, you cannot delete the date from the images later.
- The dates are doubly printed if you set the product to print dates when printing the images using PCs or printers.
- The recorded time of the image cannot be superimposed on the image.
- [ Write Date] is not available for RAW images.

Color Space (still image)

The way colors are represented using combinations of numbers or the range of color reproduction is called “color space.” You can change the color space depending on the purpose of the image.

1. MENU →  (Camera Settings) → [ Color Space] → desired setting.

Menu item details

sRGB:

This is the standard color space of the digital camera. Use [sRGB] in normal shooting, such as when you intend to print out the images without any modification.

AdobeRGB:

This color space has a wide range of color reproduction. When a large part of the subject is

vivid green or red, Adobe RGB is effective. The file name of the image starts with “_DSC.”

Note

- [AdobeRGB] is for applications or printers that support color management and DCF2.0 option color space. Images may not be printed or viewed in the correct colors if you use applications or printers that do not support Adobe RGB.
- When displaying images that were recorded with [AdobeRGB] on non-Adobe RGB-compliant devices, the images will be displayed with low saturation.

[148] How to Use | Using shooting functions | Setting the other functions of this product

Grid Line

Sets whether the grid line is displayed or not. The grid line will help you to adjust the composition of images.

1. MENU →  (Custom Settings) → [Grid Line] → desired setting.

Menu item details

Rule of 3rds Grid:

Place main subjects close to one of the grid lines that divide the image into thirds for a well-balanced composition.

Square Grid:

Square grids make it easier to confirm the horizontal level of your composition. This is suitable to determine the quality of the composition when shooting landscape, close-up, or duplicated images.

Diag. + Square Grid:

Place a subject on the diagonal line to express an uplifting and powerful feeling.

Off:

Does not display the grid line.

[149] How to Use | Using shooting functions | Setting the other functions of this product

Auto Review

You can check the recorded image on the screen right after the shooting. You can also set the display time for Auto Review.

1. MENU →  (Custom Settings) → [Auto Review] → desired setting.

Menu item details

10 Sec/5 Sec/2 Sec:

Displays the recorded image on the screen right after shooting for the selected duration of time. If you perform a magnifying operation during Auto Review, you can check that image using the magnified scale.

Off:

Does not display the Auto Review.

Note

- When the product is enlarging an image using image processing, it may temporarily display the original image prior to enlarging and then display the enlarged image.
- The DISP (Display Setting) settings are applied for the Auto Review display.

[150] How to Use | Using shooting functions | Setting the other functions of this product

Live View Display

Sets whether or not to show images altered with effects of the exposure compensation, white balance, [Creative Style], or [Picture Effect] on the screen.

1. MENU →  (Custom Settings) → [Live View Display] → desired setting.

Menu item details

Setting Effect ON:

Displays Live View in conditions close to what your picture will look like as a result of applying all your settings. This setting is useful when you want to shoot pictures while checking the results of the shot on the Live View screen.

Setting Effect OFF:

Displays Live View without the effects of exposure compensation, white balance, [Creative Style], or [Picture Effect]. When this setting is used, you can easily check the image composition.

Live View is always displayed with the appropriate brightness even in [Manual Exposure] mode.

When [Setting Effect OFF] is selected, the  icon is displayed on the Live View screen.

Note

- When the shooting mode is set to [Intelligent Auto], [Superior Auto], [Sweep Panorama],

[Movie] or [Scene Selection], [Live View Display] cannot be set to [Setting Effect OFF].

- When [Live View Display] is set to [Setting Effect OFF], the brightness of the shot image will not be the same as that of the displayed Live View.

Hint

- When you use a third-party flash, such as a studio flash, Live View Display may be dark for some shutter speed settings. When [Live View Display] is set to [Setting Effect OFF], Live View Display will be displayed brightly, so that you can easily check the composition.

[151] How to Use | Using shooting functions | Setting the other functions of this product

Bright Monitoring

Allows you to adjust the composition when shooting in dark environments. By extending the exposure time, you can check the composition on the viewfinder/monitor even in dark locations such as under the night sky.

1. MENU →  (Custom Settings) → [Custom Key(Shoot.)] → assign the [Bright Monitoring] function to the desired key.
2. Press the key to which you assigned the [Bright Monitoring] function, then shoot an image.
 - The brightness due to [Bright Monitoring] will continue after shooting.
 - To return the monitor brightness to normal, press the key to which you assigned the [Bright Monitoring] function once again.

Note

- During [Bright Monitoring], [Live View Display] will automatically switch to [Setting Effect OFF], and setting values such as exposure compensation will not be reflected in the live view display. It is recommended that you use [Bright Monitoring] only in dark locations.
- [Bright Monitoring] will be automatically cancelled in the following situations.
 - When the camera is turned off.
 - When the mode dial is turned.
 - When the focus mode is set to other than manual focus.
 - When [ MF Assist] is set to [On].
 - When [Focus Magnifier] is selected.
- During [Bright Monitoring], the shutter speed may be slower than normal while shooting in dark locations.

FINDER/MONITOR

Sets the method for switching the display between Electronic Viewfinder and the screen.

1. MENU →  (Custom Settings) → [FINDER/MONITOR] → desired setting.

Menu item details

Auto:

When you look into the Electronic Viewfinder, the display is switched to the Electronic Viewfinder automatically.

Viewfinder(Manual):

The screen is turned off and the image is displayed only in the Electronic Viewfinder.

Monitor(Manual):

The Electronic Viewfinder is turned off and the image is always displayed on the screen.

Hint

- You can assign the [FINDER/MONITOR] function to your preferred key. MENU →  (Custom Settings) → [Custom Key(Shoot.)] → set [Finder/Monitor Sel.] to the preferred key.
- To turn off automatic switching of the display using the eye sensor, set [FINDER/MONITOR] to [Viewfinder(Manual)] or [Monitor(Manual)].

Note

- When the Electronic Viewfinder is pushed down, the images are always displayed on the screen regardless of the [FINDER/MONITOR] setting.

Release w/o Card

Sets whether the shutter can be released when no memory card has been inserted.

1. MENU →  (Custom Settings) → [Release w/o Card] → desired setting.

Menu item details

Enable:

Releases the shutter even if no memory card has been inserted.

Disable:

Does not release the shutter when no memory card has been inserted.

Note

- When no memory card has been inserted, the images shot will not be saved.
- The default setting is [Enable]. It is recommended that you select [Disable] prior to actual shooting.

[154] How to Use | Using shooting functions | Setting the other functions of this product
Shading Comp.

Compensates for the shaded corners of the screen, caused by certain lens characteristics.

1. MENU →  (Custom Settings) → [Lens Comp.] → [Shading Comp.] → desired setting.

Menu item details

Auto:

Compensates for darker corners of the screen automatically.

Off:

Does not compensate for darker corners of the screen.

[155] How to Use | Using shooting functions | Setting the other functions of this product
Chro. Aber. Comp.

Reduces the color deviation at the corners of the screen, caused by certain lens characteristics.

1. MENU →  (Custom Settings) → [Lens Comp.] → [Chro. Aber. Comp.] → desired setting.

Menu item details

Auto:

Reduces the color deviation automatically.

Off:

Does not compensate for the color deviation.

[156] How to Use | Using shooting functions | Setting the other functions of this product

Distortion Comp.

Compensates for the distortion of the screen, caused by certain lens characteristics.

1. MENU →  (Custom Settings) → [Lens Comp.] → [Distortion Comp.] → desired setting.

Menu item details

Auto:

Compensates for distortion of the screen automatically.

Off:

Does not compensate for distortion of the screen.

[157] How to Use | Using shooting functions | Setting the other functions of this product

Dial / Wheel Lock

You can set whether the dial and wheel will be locked by pressing and holding the Fn (Function) button.

1. MENU →  (Custom Settings) → [Dial / Wheel Lock] → desired setting.

Menu item details

Lock:

Locks the control dial and control wheel.

Unlock:

Does not lock the control dial or control wheel even if you press and hold the Fn (Function) button.

Hint

- You can release the locked dial/control wheel by holding the Fn (Function) button down.

[158] How to Use | Using shooting functions | Setting the other functions of this product

Deactivate Monitor

When you press the key to which the [Deactivate Monitor] function has been assigned, the monitor turns black, and the screen display is locked to [No Disp. Info.].

1. MENU →  (Custom Settings) → [Custom Key(Shoot.)] → set the [Deactivate Monitor] function to the desired key.
2. Press the key to which [Deactivate Monitor] was assigned.

Note

- Even if you perform [Deactivate Monitor], the backlight of monitor remains on. To turn off the backlight, switch the monitor mode to viewfinder mode using the [FINDER/MONITOR] function.

[159] How to Use | Using shooting functions | Setting the other functions of this product

LPF Effect

This camera is equipped with an adjustable optical low pass filter. By adjusting [LPF Effect] to match the subject, you can give priority to resolution, or reduce moiré and false color.

1. MENU →  (Camera Settings) → [LPF Effect] → desired setting.

Menu item details

(Off):

Does not use [LPF Effect]. Gives priority to resolution.



(Standard):

Balances resolution with moiré and false color reduction.

(High):

Gives priority to reducing moiré and false color.

Note

- You may not be able to achieve satisfactory results, depending on the camera settings and the subject.
-  is displayed on the monitor while the settings switch. You can shoot images, but [LPF Effect] may not work properly.  is displayed on each image shot while the settings were switching.
- [LPF Effect] is locked to [Off] in the following shooting modes:
 - [Intelligent Auto]
 - [Superior Auto]
 - [Scene Selection]
 - [Sweep Panorama]
 - [Movie]

[160] How to Use | Viewing | Viewing still images

Playing back images

Plays back the recorded images.

1. Press the  (Playback) button to switch to the playback mode.
2. Select the image with the control wheel.

Hint

- The product creates an image database file on a memory card to record and play back images. An image that is not registered in the image database file may not be played back correctly. To play back images shot using other devices, register those images to the image database file using MENU → [Setup] → [Recover Image DB].

[161] How to Use | Viewing | Viewing still images

Playback zoom

Enlarges the image being played back.

1. Display the image you want to enlarge, and then press the  button.
 - Turn the control wheel to adjust the zoom scale.
By rotating the control dial, you can switch to the previous or next image while

keeping the same zoom scale.

- The view will zoom in on the part of the image where the camera focused during shooting. If the focus location information cannot be obtained, the camera will zoom in on the center of the image.

2. Select the portion you want to enlarge by pressing the top/bottom/right/left side of the control wheel.

3. Press the MENU button, or  in the center of the control wheel to exit the playback zoom.

Hint

- You can also enlarge an image being played back using MENU.

Note

- You cannot enlarge movies.

[162] How to Use | Viewing | Viewing still images

Image Index

You can display multiple images at the same time in playback mode.

1. Press the  (Image Index) button while the image is being played back.

To change the number of images to be displayed

MENU →  (Playback) → [Image Index] → desired setting.

Menu item details

9 Images/25 Images

To return to single-image playback

Select the desired image and press  on the center of the control wheel.

To display a desired image quickly

Select the bar on the left of the image index screen using the control wheel, then press the top/bottom side of the control wheel. While the bar is being selected, you can display the calendar screen or folder selection screen by pressing  in the center. In addition, you can switch View Mode by selecting an icon.

Switching the screen display (during playback)

Switches the screen display.



1. Press the DISP (Display Setting) button.
 - The screen display switches in the order “Display Info. → Histogram → No Disp. Info. → Display Info.” each time you press the DISP button.
 - The DISP (Display Setting) settings are applied for the Auto Review display.

Note

- The histogram is not displayed in the following situations:
 - During movie playback
 - During scrolling playback of panoramic images
 - During slideshows
 - During Folder View (MP4)
 - During AVCHD View
 - During XAVC S HD View

Deleting a displayed image

You can delete an image displayed.

1. Display the image you want to delete.
2. Press the  (Delete) button.
3. Select [Delete] using the control wheel, then press  on the center of the control wheel.

Deleting multiple selected images





You can delete multiple selected images.

1. MENU →  (Playback) → [Delete] → desired setting.

Menu item details

Multiple Img.:

Deletes the selected images.

- (1) Select the images to be deleted, then press  on the center of the control wheel. The  mark is displayed in the check box. To cancel the selection, press  again to remove the  mark.
- (2) To delete other images, repeat step (1).
- (3) MENU → [OK] → Press  on the center.

All in this Folder:

Deletes all images in the selected folder.

All with this date:

Deletes all images in the selected date range.

Hint

- Perform [Format] to delete all images, including protected images.



Note

- The menu items that can be selected differ depending on the [View Mode] setting.

[166] How to Use | Viewing | Playing back movies

Playing back movies













Plays back the recorded movies.

1. Press the  (playback) button to switch to playback mode.
2. Select the movie to be played back using the control wheel.
3. To play back movies, press  on the center.

Available operations during movie playback

You can perform slow playback and sound volume adjustment, etc. by pressing the bottom

side of the control wheel.

-  : Playback
-  : Pause
-  : Fast-forward
-  : Fast-rewind
-  : Forward slow playback
-  : Reverse slow playback
-  : Next movie file
-  : Previous movie file
-  : Displays the next frame
-  : Displays the previous frame
-  : Sound volume adjustment
-  : Closes the operation panel



Hint

- “Forward slow playback,” “Reverse slow playback,” “Displays the next frame” and “Displays the previous frame” are available during pause.

[167] How to Use | Viewing | Viewing panoramic images

Playing back panoramic images

The product automatically scrolls a panoramic image from end to end.

1. Press the  (playback) button to switch to playback mode.
2. Select the panoramic image to be played back using the control wheel.
3. Press  on the center to play back the image.



- To pause playback, press  on the center again.
- To return to the display of the entire image, press the MENU button.



Note

- Panoramic images shot using other products may be displayed in a different size from the actual size, or may not scroll correctly.

[168] How to Use | Viewing | Printing

Specify Printing

You can specify in advance on the memory card which still images you want to print out later.





The **DPOF** (print order) icon will appear on the specified images. DPOF refers to “Digital Print Order Format.”

1. MENU →  (Playback) → [Specify Printing] → desired setting.

Menu item details

Multiple Img.:

Selects images to order printing.

- (1) Select an image and press  on the center of the control wheel. The  mark is displayed in the check box. To cancel the selection, press  and delete the  mark.
- (2) Repeat step (1) to print other images.
- (3) MENU → [OK] → Press  on the center.

Cancel All:

Clears all DPOF marks.

Print Setting:

Sets whether to print the date on images registered with DPOF marks.

Note

- You cannot add the DPOF mark to the following files:
 - Movies
 - RAW images

[169] How to Use | Viewing | Using viewing functions

View Mode

Sets the View Mode (image display method).

1. MENU →  (Playback) → [View Mode] → desired setting.

Menu item details

Date View:

Displays the images by date.

Folder View(Still):

Displays only still images.

Folder View(MP4):

Displays only MP4-format movies.

AVCHD View:

Displays only AVCHD-format movies.

XAVC S HD View:

Displays only XAVC S HD-format movies.

[170] How to Use | Viewing | Using viewing functions

Display Rotation

Selects the orientation when playing back recorded still images.

1. MENU →  (Playback) → [Display Rotation] → desired setting.

Menu item details

Auto:

When you rotate the camera, the displayed image rotates automatically detecting the orientation of the camera.

Manual:

A portrait image is displayed as a vertical image. If you have set the image orientation using the [Rotate] function, the image will be displayed accordingly.

Off:

Always displays in landscape orientation.

[171] How to Use | Viewing | Using viewing functions

Slide Show

Automatically plays back images continuously.

1. MENU →  (Playback) → [Slide Show] → desired setting.
2. Select [Enter].

Menu item details

Repeat:

Select [On], in which images are played back in a continuous loop, or [Off], in which the product exits the slideshow when all the images are played back once.

Interval:

Select the display interval for images from among [1 Sec], [3 Sec], [5 Sec], [10 Sec] or [30 Sec].

To quit the slideshow in the middle of playback

Press the MENU button to quit the slideshow. You cannot pause the slideshow.



Hint

- You can activate a slideshow only when [View Mode] is set to [Date View] or [Folder View(Still)].

[172] How to Use | Viewing | Using viewing functions

Rotate

Rotates a recorded still image counter-clockwise.

1. MENU →  (Playback) → [Rotate].
2. Press  on the center of the control wheel.
The image is rotated counter-clockwise. The image rotates as you press  on the center. If you rotate the image once, the image remains rotated even after the product is turned off.

Note

- You cannot rotate the movies.
- You may not be able to rotate images shot using other products.
- When viewing rotated images on a computer, the images may be displayed in their original orientation depending on the software.

Protect





Protects recorded images against accidental erasure. The  mark is displayed on protected images.

1. MENU →  (Playback) → [Protect] → desired setting.

Menu item details

Multiple Img.:

Applies or cancels the protection of the selected multiple images.

- (1) Select the image to be protected, then press  on the center of the control wheel. The  mark is displayed in the check box. To cancel the selection, press  again to remove the  mark.
- (2) To protect other images, repeat step (1).
- (3) MENU → [OK] → Press  on the center.

All in this Folder:

Protects all images in the selected folder.

All with this date:

Protects all images in the selected date range.

Cancel All in this Folder:

Cancels the protection of all images in the selected folder.

Cancel All with this date:

Cancels the protection of all images in the selected date range.

Note

- The menu items that can be selected differ depending on the [View Mode] setting.

4K Still Image PB

Outputs still images in 4K resolution to an HDMI-connected TV that supports 4K.

1. Turn off this product and the TV.

2. Connect the HDMI micro terminal of this product to the HDMI jack of the TV using an HDMI cable (sold separately).

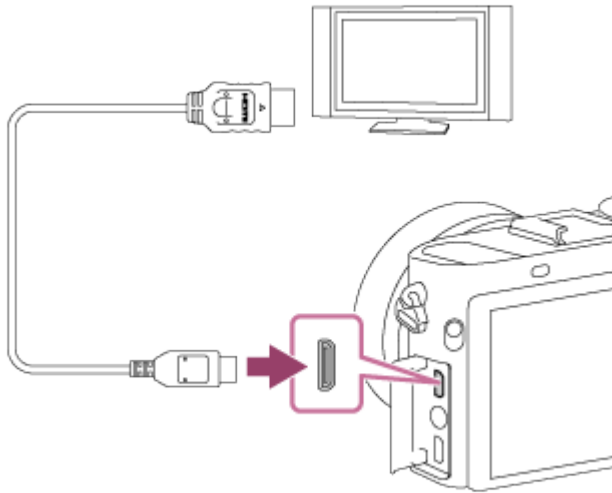

3. Turn on the TV and switch the input.
4. Turn on this product.
5. Play back a still image, then press the bottom of the control wheel.
The still image is output in 4K resolution.
 - You can output still images in 4K resolution by selecting MENU →  (Playback) → [4K Still Image PB] → [OK].

Note

- This menu is only available with 4K-compatible TVs. For details, refer to the operating instructions of the TV.

[175] How to Use | Viewing | Viewing images on a TV

Viewing images on an HD TV

To view images stored on this product using a TV, an HDMI cable (sold separately) and an HD TV equipped with an HDMI jack are required.

1. Turn off both this product and the TV.
2. Connect the HDMI micro terminal of this product to the HDMI jack of the TV using an HDMI cable (sold separately).

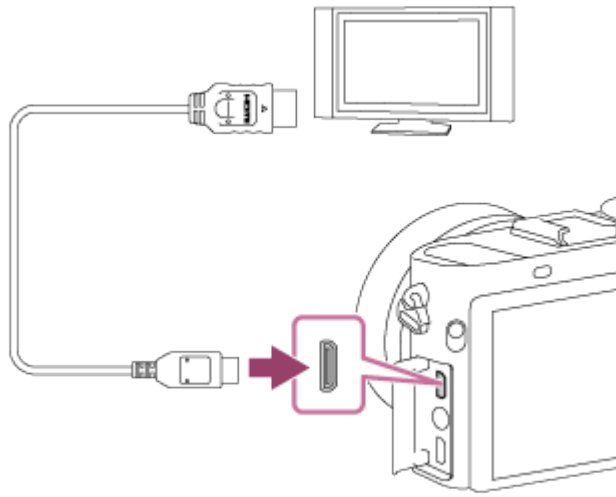

3. Turn on the TV and switch the input.
4. Turn on this product.
Images shot with the product appear on the TV screen.

Hint

- This product is compatible with the PhotoTV HD standard. If you connect Sony PhotoTV HD-compatible devices using an HDMI cable (sold separately), the TV is set to the image quality suitable for viewing still images, and a whole new world of photos can be enjoyed in breathtaking high quality.
- You can connect this product to Sony PhotoTV HD-compatible devices with a USB terminal using the supplied micro USB cable.
- The PhotoTV HD allows for a highly-detailed, photo-like expression of subtle textures and colors.
- For details, refer to the operating instructions supplied with the compatible TV.

Note

- Do not connect this product and another device using the output terminals of both. Doing so may cause a malfunction.
- Some devices may not work properly when connected to this product. For example, they may not output video or audio.
- Use an HDMI cable with the HDMI logo or a genuine Sony cable.
- Use an HDMI cable that is compatible with the HDMI micro terminal of the product and the HDMI jack of the TV.
- If images do not appear on the TV screen properly, select [1080i] or [1080p] using  (Setup) → [HDMI Settings] → [HDMI Resolution] according to the TV to be connected.

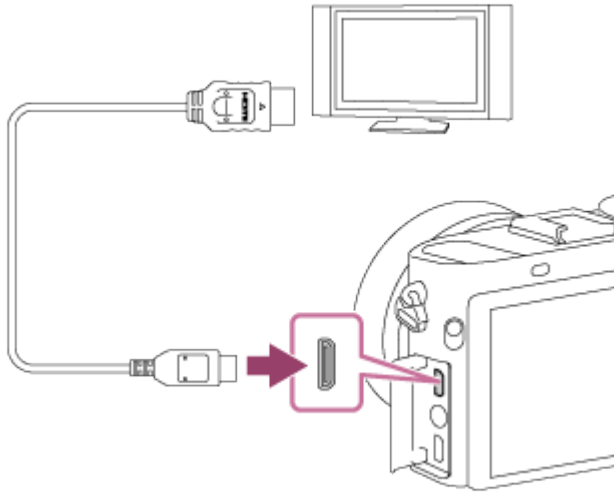

By connecting this product to a TV that supports “BRAVIA” Sync using an HDMI cable (sold separately), you can operate this product's playback functions with the TV remote control.

1. Turn off both this product and the TV.
2. Connect the HDMI micro terminal of the product to the HDMI jack of the TV using an HDMI cable (sold separately).



3. Turn on the TV and switch the input.
4. Turn on this product.
5. MENU →  (Setup) → [HDMI Settings] → [CTRL FOR HDMI] → [On].
6. Press the SYNC MENU button on the TV remote control, and select the desired mode.

Note

- If the product is not in playback mode, press the  (Playback) button.
- Only TVs that support “BRAVIA” Sync can provide SYNC MENU operations. For details, refer to the operating instructions supplied with the TV.
- If the product performs unwanted operations in response to the TV remote control when the product is connected to another manufacturer’s TV using an HDMI connection, select MENU →  (Setup) → [HDMI Settings] → [CTRL FOR HDMI] → [Off].

[177] How to Use | Changing settings | Setup menu

Monitor Brightness

You can adjust the brightness of the screen.

1. MENU →  (Setup) → [Monitor Brightness] → desired setting.

Menu item details

Auto:

Adjusts the brightness automatically.

Manual:

Adjusts the brightness within the range of -2 to +2.

Sunny Weather:

Sets the brightness appropriately for shooting outdoors.

Note

- The [Sunny Weather] setting is too bright for shooting indoors. Set [Monitor Brightness] to [Auto] or [Manual] for indoor shooting.
- Do not cover the light sensor with your hand, etc., when [Monitor Brightness] is set to [Auto] .
- The monitor brightness is locked at [-2] when using Wi-Fi functions.

[178] How to Use | Changing settings | Setup menu

Viewfinder Bright.

When using an electronic viewfinder, this product adjusts the brightness of the electronic viewfinder according to the surrounding environment.

1. MENU →  (Setup) → [Viewfinder Bright.] → desired setting.

Menu item details

Auto:

Adjusts the brightness of the electronic viewfinder automatically.

Manual:

Selects the brightness of the electronic viewfinder from the range -2 to +2.

Note

- When using an external viewfinder (sold separately), the brightness range is from -1 to +1.
 - You cannot use the viewfinder while using Wi-Fi functions. The camera will switch to screen display mode.
-

Finder Color Temp.

Adjusts the color temperature of the electronic viewfinder.

1. MENU →  (Setup) → [Finder Color Temp.] → desired setting.

Menu item details

-2 to +2:

When you select “-,” the viewfinder screen changes to a warmer color, and when you select “+,” it changes to a colder color.

Note

- When using an external viewfinder (sold separately), [Finder Color Temp.] cannot be changed.

Volume Settings

Sets the sound volume for movie playback.

1. MENU →  (Setup) → [Volume Settings] → desired setting.

Adjusting the volume during playback

Press the bottom of the control wheel while playing back movies to display the operation panel, then adjust the volume. You can adjust the volume while listening to the actual sound.

Audio signals

Selects whether the product produces a sound or not.

1. MENU →  (Setup) → [Audio signals] → desired setting.

Menu item details

On:

Sounds are produced for example when the focus is achieved by pressing the shutter button halfway down.

Shutter:

Only the shutter sound is produced.

Off:

Sounds are not produced.

Note

- If [Focus Mode] is set to [Continuous AF], the camera will not beep when it focuses on a subject.

[182] How to Use | Changing settings | Setup menu

Upload Settings(Eye-Fi)

Sets whether to use the upload function when using an Eye-Fi card (commercially available). This item appears when an Eye-Fi card is inserted into the product's memory card slot.

1. MENU →  (Setup) → [Upload Settings] → desired setting.
2. Set your Wi-Fi network or destination on the Eye-Fi card.
For details, refer to the manual supplied with the Eye-Fi card.
3. Insert the Eye-Fi card you have set up into the product, and shoot still images.
Images are transferred to your computer, etc., automatically via the Wi-Fi network.

Menu item details

On:

Enables the upload function.

Off:

Disables the upload function.

Communication status screen display

: Standby. No images are to be sent.



: Upload standby

: Connecting

: Uploading

: Error

Note

- Eye-Fi cards are only sold in certain countries/regions.
- For more information on Eye-Fi cards, please contact the manufacturer or vendor directly.
- Eye-Fi cards can be used only in the countries/regions where they were purchased. Use Eye-Fi cards in accordance with the law of the countries/regions where you purchased the card.
- Eye-Fi cards are equipped with a wireless LAN function. Do not insert an Eye-Fi card into the product in locations in which their use is prohibited, such as on an airplane. When an Eye-Fi card is inserted into the product, set [Upload Settings] to [Off]. When the upload function is set to [Off], the  indicator will be displayed on the product.
- Power save mode will not function during uploading.
- If  (error) is displayed, remove the memory card and reinsert it, or turn the product off and then on again. If the indicator appears again, the Eye-Fi card may be damaged.
- Wireless LAN communication may be influenced by other communication devices. If the communication status is poor, move closer to the access point to be connected.
- This product does not support Eye-Fi “Endless Memory Mode.” Before using an Eye-Fi card, be sure that “Endless Memory Mode” is turned off.

[183] How to Use | Changing settings | Setup menu

Tile Menu

Selects whether to always display the first screen of the menu when you press the MENU button.

1. MENU →  (Setup) → [Tile Menu] → desired setting.

Menu item details

On:

Always displays the first screen of the menu (Tile Menu).

Off:

Deactivates the Tile Menu display.

[184] How to Use | Changing settings | Setup menu

Mode Dial Guide

You can display the description of a shooting mode when you turn the mode dial and change the settings available for that shooting mode.

1. MENU →  (Setup) → [Mode Dial Guide] → desired setting.

Menu item details

On:

Displays the Mode Dial Guide.

Off:

Does not display the Mode Dial Guide.

[185] How to Use | Changing settings | Setup menu

Delete confirm.

You can set whether [Delete] or [Cancel] is selected as the default setting on the delete confirmation screen.

1. MENU →  (Setup) → [Delete confirm.] → desired setting.

Menu item details

"Delete" first:

[Delete] is selected as the default setting.

"Cancel" first:

[Cancel] is selected as the default setting.

[186] How to Use | Changing settings | Setup menu

Display Quality

You can change the display quality.

1. MENU →  (Setup) → [Display Quality] → desired setting.

Menu item details

High:

Displays in high quality.

Standard:

Displays in standard quality.

Note

- When [High] is set, battery consumption will be higher than when [Standard] is set.

[187] How to Use | Changing settings | Setup menu

Pwr Save Start Time

You can set time intervals to automatically switch to power save mode. To return to shooting mode, perform an operation such as pressing the shutter button halfway down.

1. MENU →  (Setup) → [Pwr Save Start Time] → desired setting.

Menu item details

30 Min/5 Min/2 Min/1 Min/10 Sec

Note

- Turn off the product when you do not use it for a long time.
- The power save function is not activated when power is being supplied via USB, when playing back slideshows, when recording movies, or when connected to a computer or TV.

[188] How to Use | Changing settings | Setup menu

NTSC/PAL Selector

Plays back movies recorded with the product on a NTSC/PAL system TV.

1. MENU →  (Setup) → [NTSC/PAL Selector] → [Enter]

Note

- If you insert a memory card that has previously been formatted with the PAL system, a message telling you that you must re-format the card appears. When you record using the NTSC system, re-format the memory card or use another memory card.
- When the NTSC mode is selected, the “Running on NTSC.” message always appears on

the start-up screen each time you turn the product on.

[189] How to Use | Changing settings | Setup menu

Demo Mode

The [Demo Mode] function displays the movies recorded on the memory card automatically (demonstration), when the camera has not been operated for a certain time. Normally select [Off].

1. MENU →  (Setup) → [Demo Mode] → desired setting.

Menu item details

On:

The movie playback demonstration starts automatically if the product is not operated for about one minute. Only protected AVCHD movies are played back.

Set the view mode to [AVCHD View], and protect the movie file with the oldest recorded date and time.

Off:

Does not show the demonstration.

Note

- You can set this item only when the product is powered by the AC Adaptor (supplied).
 - Even if [On] is selected, the product does not start a demonstration if there is no movie file on the memory card.
 - When [On] is selected, the product does not switch to power save mode.
-

[190] How to Use | Changing settings | Setup menu

HDMI Resolution

When you connect the product to a High Definition (HD) TV with HDMI terminals using an HDMI cable (sold separately), you can select HDMI Resolution to output images to the TV.

1. MENU →  (Setup) → [HDMI Settings] → [HDMI Resolution] → desired setting.

Menu item details

Auto:

The product automatically recognizes an HD TV and sets the output resolution.

1080p:

Outputs signals in HD picture quality (1080p).

1080i:

Outputs signals in HD picture quality (1080i).



Note

- If the images are not displayed properly using the [Auto] setting, select either [1080i] or [1080p], based on which TV is to be connected.

[191] How to Use | Changing settings | Setup menu

24p/60p Output (movie) (Only for 1080 60i compatible models)

Set 1080/24p or 1080/60p as the HDMI output format when [ Record Setting] is set to [24p 24M(FX)], [24p 17M(FH)], or [24p 50M].

1. MENU →  (Setup) → [HDMI Settings] → [HDMI Resolution] → [1080p].
2. MENU →  (Setup) → [HDMI Settings] → [ 24p/60p Output] → desired setting.

Menu item details

60p:

Movies are output as 60p.

24p:

Movies are output as 24p.

Note

- Steps 1 and 2 can be set in either order.
- When [ Record Setting] is set to other than the above, this setting is canceled, and HDMI video is output according to the [HDMI Resolution] settings.

[192] How to Use | Changing settings | Setup menu

CTRL FOR HDMI

When connecting this product to a “BRAVIA” Sync-compatible TV using an HDMI cable (sold separately), you can operate this product by aiming the TV remote control at the TV.

1. MENU →  (Setup) → [HDMI Settings] → [CTRL FOR HDMI] → desired setting.

Menu item details

On:

You can operate this product with a TV’s remote control.

Off:

You cannot operate this product with a TV’s remote control.

Note

- [CTRL FOR HDMI] is available only with a “BRAVIA” Sync-compatible TV.

[193] How to Use | Changing settings | Setup menu

HDMI Info. Display

Selects whether to display the shooting information when this product and the TV are connected using an HDMI cable (sold separately).

1. MENU →  (Setup) → [HDMI Settings] → [HDMI Info. Display] → desired setting.

Menu item details

On:

Displays the shooting information on the TV. The recorded image and the shooting information are displayed on the TV, while nothing is displayed on the camera’s monitor.

Off:

Does not display the shooting information on the TV. Only the recorded image is displayed on the TV, while the recorded image and the shooting information are displayed on the camera’s monitor.

[194] How to Use | Changing settings | Setup menu

USB Connection

Selects the appropriate USB connection method for each computer or USB device connected to this product.

1. MENU →  (Setup) → [USB Connection] → desired setting.

Menu item details

Auto:

Establishes a Mass Storage or MTP connection automatically, depending on the computer or other USB devices to be connected. Windows 7 or Windows 8 computers are connected in MTP, and their unique functions are enabled for use.

Mass Storage:

Establishes a Mass Storage connection between this product, a computer, and other USB devices.

MTP:

Establishes an MTP connection between this product, a computer, and other USB devices. Windows 7 or Windows 8 computers are connected in MTP, and their unique functions are enabled for use.

PC Remote:

Uses “Remote Camera Control” to control this product from the computer, including such functions as shooting and storing images on the computer.

Note

- It may take some time to make the connection between this product and a computer when [USB Connection] is set to [Auto].
- If Device Stage* is not displayed with Windows 7 or Windows 8, set [USB Connection] to [Auto].

* Device Stage is a menu screen used to manage connected devices, such as a camera (Function of Windows 7 or Windows 8).

[195] How to Use | Changing settings | Setup menu

USB LUN Setting

Enhances compatibility by limiting of USB connection functions.

1. MENU →  (Setup) → [USB LUN Setting] → desired setting.

Menu item details

Multi:

Normally, use [Multi].

Single:

Set [USB LUN Setting] to [Single] only if you cannot make a connection.

[196] How to Use | Changing settings | Setup menu

USB Power Supply

Sets whether to supply power via the micro USB cable when the product is connected to a computer or an USB device.

1. MENU →  (Setup) → [USB Power Supply] → desired setting.

Menu item details

On:

Power is supplied to the product via a micro USB cable when the product is connected to a computer, etc.

Off:

Power is not supplied to the product via a micro USB cable when the product is connected to a computer, etc. If you use the supplied AC Adaptor, power will be supplied even when [Off] is selected.

Note

- Insert the battery pack into the product to supply power via USB cable.
-

[197] How to Use | Changing settings | Setup menu

Language

Selects the language to be used in the menu items, warnings and messages.

1. MENU →  (Setup) → [ Language] → desired language.
-

[198] How to Use | Changing settings | Setup menu

Date/Time Setup

Sets the date and time again.

1. MENU →  (Setup) → [Date/Time Setup] → desired setting.

Menu item details

Daylight Savings:

Selects Daylight Savings [On]/[Off].

Date/Time:

Sets the date and time.

Date Format:

Selects the date and time display format.

[199] How to Use | Changing settings | Setup menu

Area Setting

Sets the area where you are using the product.

1. MENU →  (Setup) → [Area Setting] → desired area.

[200] How to Use | Changing settings | Setup menu

Copyright Info

You can write copyright information onto the still images.

1. MENU →  (Setup) → [Copyright Info] → desired setting.
2. When you select [Set Photographer] or [Set Copyright], a keyboard appears on the screen. Enter your desired name.

Menu item details

Write Copyright Info:

Sets whether to write copyright information. ([On]/[Off])

- If you select [On], an  icon will appear on the shooting screen.



Set Photographer:

Sets the photographer name.

Set Copyright:

Sets the copyright holder name.

Disp. Copyright Info:

Displays the current copyright information.

Hint

How to use the keyboard

When manual character entry is required, a keyboard is displayed on the screen.



1. Input box

The characters you entered are displayed.

2. Switch character types

Each time you press ● in the center of the control wheel, the character type will switch between alphabet letters, numerals and symbols.

3. Keyboard

Each time you press ● in the center, the characters corresponding to that key will be displayed one-by-one in order.

For example: If you want to enter “abd”

Select the key for “abc” and press ● once to display “a” → select “➡” ((5) Move cursor) and press ● → select the key for “abc” and press ● twice to display “b” → select the key for “def” and press ● once to display “d”.

4. Finalize

Finalizes the entered characters.

5. Move cursor

Moves the cursor in the input box to the right or left.

6. Delete

Deletes the character preceding the cursor.

7. 

Switches the next character to a capital or lowercase letter.

8. 

Enters a space.

- To cancel input, select [Cancel].

Note

- You can only enter alphanumeric characters and symbols for [Set Photographer] and [Set Copyright]. You can enter up to 46 letters.
- A  icon appears during the playback of images with copyright information.
- In order to prevent unauthorized use of [Copyright Info], be sure to clear the [Set Photographer] and [Set Copyright] columns before lending out or handing over your camera.

[201] How to Use | Changing settings | Setup menu

Format

Formats (initializes) the memory card. When you use a memory card with this product for the first time, it is recommended that you format the card using the product for stable performance of the memory card. Note that formatting permanently erases all data on the memory card, and is unrecoverable. Save valuable data on a computer, etc.

1. MENU →  (Setup) → [Format].

Note

- Formatting permanently erases all data including even protected images.

[202] How to Use | Changing settings | Setup menu

File Number

Selects how to assign file numbers to recorded still images and MP4 movies.

1. MENU →  (Setup) → [File Number] → desired setting.

Menu item details

Series:

The product will assign numbers to files sequentially up to “9999” without resetting.

Reset:

The product resets numbers when a file is recorded in a new folder and assigns numbers to files starting with “0001.”

(When the recording folder contains a file, a number one higher than the largest number is assigned.)

[203] How to Use | Changing settings | Setup menu

Select REC Folder

You can change the folder on the memory card where still images and MP4 movies are to be recorded.

1. MENU →  (Setup) → [Select REC Folder] → desired folder.

Note

- You cannot select the folder when [Folder Name] is set to [Date Form].

[204] How to Use | Changing settings | Setup menu

New Folder

Creates a new folder on the memory card for recording still images and MP4 movies. A new folder is created with a folder number one greater than the largest folder number currently used. Images are recorded in the newly created folder. A folder for still images and a folder for MP4 movies that have the same number are created at the same time.

1. MENU →  (Setup) → [New Folder].

Note

- When you insert a memory card that was used with other equipment into this product and

shoot images, a new folder may be automatically created.

- Up to 4,000 images in total can be stored in one folder. When the folder capacity is exceeded, a new folder may be automatically created.

[205] How to Use | Changing settings | Setup menu

Folder Name

Still images are recorded in a folder that is automatically created inside the DCIM folder on the memory card. You can change the way folder names are assigned.

1. MENU →  (Setup) → [Folder Name] → desired setting.

Menu item details

Standard Form:

The folder name form is as follows: folder number + MSDCF.

Example: 100MSDCF

Date Form:

The folder name form is as follows: folder number + Y (the last digit)/MM/DD.

Example: 10050405 (Folder number: 100, date: 04/05/2015)

Note

- You cannot change the [Folder Name] settings for movies.

[206] How to Use | Changing settings | Setup menu

Recover Image DB

If image files were processed on a computer, problems may occur in the image database file. In such cases, the images on the memory card will not be played back on this product. If these problems happen, repair the file using [Recover Image DB].

1. MENU →  (Setup) → [Recover Image DB] → [Enter].

Note

- Use a sufficiently charged battery pack. Low battery power during repairing can cause damage to data.

[207] How to Use | Changing settings | Setup menu

Display Media Info.

Displays the recordable time of movies and the number of recordable still images for the inserted memory card.

1. MENU →  (Setup) → [Display Media Info.].

[208] How to Use | Changing settings | Setup menu

Version

Displays the version of this product's software.

1. MENU →  (Setup) → [Version].

[209] How to Use | Changing settings | Setup menu

Certification Logo (For some models only)

Displays some of the certification logos for this product.

1. MENU →  (Setup) → [Certification Logo].

[210] How to Use | Changing settings | Setup menu

Setting Reset

Resets the product to the default settings. Even if you perform [Setting Reset], the recorded

images are retained.

1. MENU →  (Setup) → [Setting Reset] → desired setting.

Menu item details

Camera Settings Reset:

Initializes the main shooting settings to the default settings.

Initialize:

Initializes all the settings to the default settings.

Note

- Be sure not to eject the battery pack while resetting.
- When you perform [Initialize], downloaded applications on the product may be uninstalled. To use these applications again, re-install them.

[211] How to Use | Using Wi-Fi functions | Connecting this product and a Smartphone

PlayMemories Mobile

To use [Smart Remote Embedded] or [Send to Smartphone], etc., the application PlayMemories Mobile should be installed on your smartphone.

Download and install the application PlayMemories Mobile from your smartphone's application store. If PlayMemories Mobile is already installed on your smartphone, be sure to update it to the latest version.

For details on PlayMemories Mobile, refer to the support page (<http://www.sony.net/pmm/>).

[212] How to Use | Using Wi-Fi functions | Connecting this product and a Smartphone

Connecting an Android smartphone to this product

1. Launch PlayMemories Mobile on your smartphone.
2. Select the model name of this product (DIRECT-xxxx: xxxx).



3. Input the password that is displayed on this product.



The smartphone is connected to the product.

[213] How to Use | Using Wi-Fi functions | Connecting this product and a Smartphone

Connecting the product to an iPhone or iPad

1. Select the model name of this product (DIRECT-xxxx:xxxx) on the Wi-Fi setting screen of your iPhone or iPad.



2. Input the password displayed on this product.



The iPhone or iPad is connected to the product.

3. Confirm that your iPhone or iPad was connected to the “SSID” shown on this product.



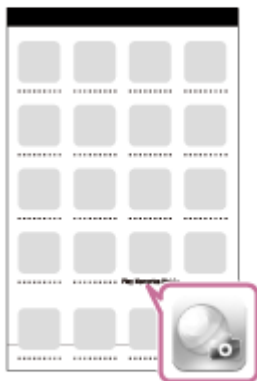

4. Return to the “Home” screen and launch PlayMemories Mobile.



[214] How to Use | Using Wi-Fi functions | Connecting this product and a Smartphone
Calling up an application using [One-touch(NFC)]

You can call up a desired application from the application menu of this product by touching an NFC-enabled Android smartphone to the product. If the application you call up has a

feature that works with the smartphone, the product and the smartphone will be connected via Wi-Fi. To use this function, register the desired application in advance.

1. MENU →  (Wireless) → [One-touch(NFC)] → desired application.
2. Switch this product to shooting mode, then touch an NFC-enabled smartphone to the  (N mark) on the product for 1-2 seconds.
 - PlayMemories Mobile launches on the smartphone, and the application you have registered launches on this product.

Note

- When the product is in playback mode, the registered application will not launch even if you touch the smartphone to the product.
- When you call up an application with one touch, even if that application does not work with a smartphone, PlayMemories Mobile on smartphone will launch. Exit PlayMemories Mobile without performing an operation. If you do not exit PlayMemories Mobile, the smartphone stays in standby connection status.
- [Smart Remote Embedded] is assigned to [One-touch(NFC)] as a default setting.

[215] How to Use | Using Wi-Fi functions | Controlling this product using a Smartphone Smart Remote Embedded

You can use a smartphone as the remote controller for this product, and shoot still images. The application PlayMemories Mobile must be installed on your smartphone.

1. MENU →  (Application) → [Application List] → [Smart Remote Embedded].
2. When the product is ready for the connection, an information screen appears on the product. Connect the smartphone and the product using that information.
 - Connection setting methods differ among smartphones.

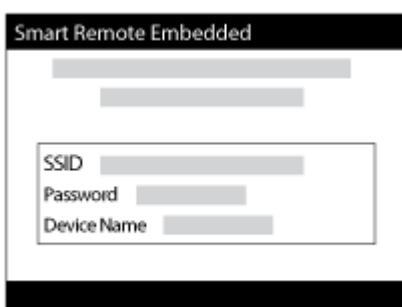

3. Check the composition of the image on the smartphone screen, and then press the

shutter button **(A)** on the smartphone to shoot an image.

- Use button **(B)** to change settings such as [EV], [Self-Timer] and [Review Check].

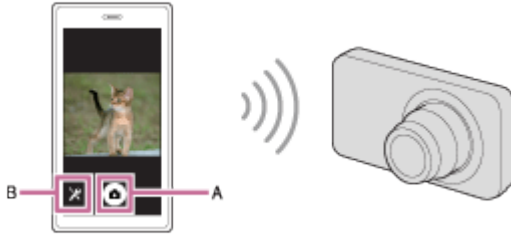

Note

- When you record still images using a smartphone as a remote controller, you cannot use the viewfinder.
- This product shares the connection information for [Smart Remote Embedded] with a device that has permission to connect. If you want to change the device that is permitted to connect to the product, reset the connection information by following these steps. MENU →  (Wireless) → [SSID/PW Reset]. After resetting the connection information, you must register the smartphone again.
- Depending on future version upgrades, the operational procedures or screen displays are subject to change without notice.

[216] How to Use | Using Wi-Fi functions | Controlling this product using a Smartphone

One-touch connection with an NFC-enabled Android smartphone (NFC One-touch remote)

You can connect this product and an NFC-enabled Android smartphone with one touch, without performing a complex setup operation.

1. Activate the NFC function of the smartphone.
2. Switch this product to shooting mode.
 - The NFC function is available only when the  (N mark) is displayed on the screen.
3. Touch the product to the smartphone.

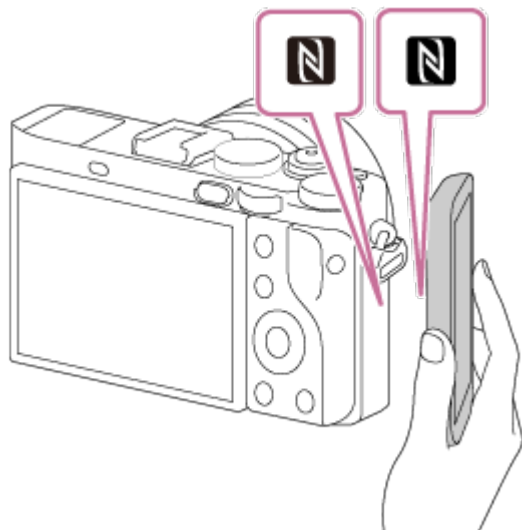

The smartphone and the product are connected, and PlayMemories Mobile launches on the smartphone.

- Touch the smartphone to the product for 1-2 seconds until PlayMemories Mobile launches.

About “NFC”



NFC is a technology that enables short-range wireless communication between various devices, such as mobile phones or IC tags, etc. NFC makes data communication simpler with just a touch on the designated touch-point.

- NFC (Near Field Communication) is an international standard of short-range wireless communication technology.

Note

- If you cannot make a connection, do as the following:
 - Launch PlayMemories Mobile on your smartphone, and then move the smartphone slowly toward the **N** (N mark) of this product.
 - If the smartphone is in a case, remove it.
 - If the product is in a case, remove it.
 - Check whether the NFC function is activated on your smartphone.
- When [Airplane Mode] is set to [On], you cannot connect this product and the smartphone. Set [Airplane Mode] to [Off].
- If this product and the smartphone are connected when the product is in playback mode, the displayed image is sent to the smartphone.

You can transfer still images/movies to a smartphone and view them. The application PlayMemories Mobile must be installed on your smartphone.

1. MENU →  (Wireless) → [Send to Smartphone] → desired setting.
 - If you press the  (Send to Smartphone) button in playback mode, the setting screen for [Send to Smartphone] will appear.
2. If the product is ready for the transfer, the information screen appears on the product. Connect the smartphone and the product using that information.
 - The setting method for connecting the smartphone and the product varies depending on the smartphone.

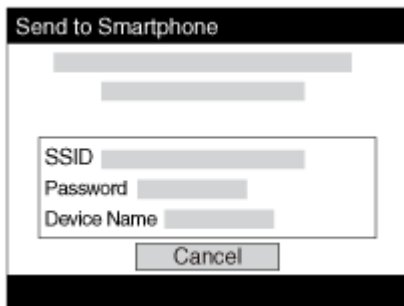

Menu item details

Select on This Device:

Selects an image on the product to be transferred to the smartphone.

(1) Select from among [This Image], [All Images on This Date] or [Multiple Images].

- The options displayed may differ depending on the View Mode selected on the camera.
- (2) If you select [Multiple Images], select the desired images using  on the control wheel, then press MENU → [Enter].

Select on Smartphone:

Displays all images recorded on the product's memory card on the smartphone.

Note

- You can only transfer images that are saved on the camera's memory card.
- You can select an image size to be sent to the smartphone from [Original], [2M] or [VGA]. To change the image size, refer to the following steps.
 - For Android smartphone
Start PlayMemories Mobile, and change the image size by [Settings] → [Copy Image Size].
 - For iPhone/iPad
Select PlayMemories Mobile in the setting menu, and change the image size by [Copy Image Size].
- Some images may not be displayed on the smartphone depending on the recording format.
- RAW images are converted to JPEG format when they are sent.
- You cannot send XAVC S or AVCHD format movies.

- This product shares the connection information for [Send to Smartphone] with a device that has permission to connect. If you want to change the device that is permitted to connect to the product, reset the connection information by following these steps. MENU → [Wireless] → [SSID/PW Reset]. After resetting the connection information, you must register the smartphone again.
- When [Airplane Mode] is set to [On], you cannot connect this product and the smartphone. Set [Airplane Mode] to [Off].

[218] How to Use | Using Wi-Fi functions | Transferring images to a Smartphone

Sending images to an Android smartphone (NFC One-touch Sharing)

With just one touch, you can connect this product and an NFC-enabled Android smartphone, and send an image displayed on the product screen directly to the smartphone. For movies, you can only transfer MP4 movies recorded with [ File Format] set to [MP4].

1. Activate the NFC function of the smartphone.
2. Display a single image on the product.
3. Touch the smartphone to the product.

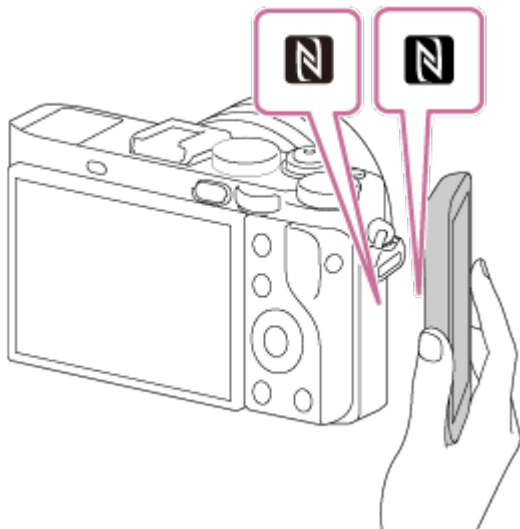

The product and the smartphone are connected, and PlayMemories Mobile automatically launches on the smartphone, and then the displayed image is sent to the smartphone.

- Before you touch the smartphone, cancel the sleep and lock-screen functions of the smartphone.
- The NFC function is available only when the  (N mark) is displayed on the product.

- Touch the smartphone to the product for 1-2 seconds until PlayMemories Mobile launches.
- To transfer two or more images, select MENU →  (Wireless) → [Send to Smartphone] to select images. After the connection enabled screen appears, use NFC to connect the product and the smartphone.

About “NFC”

NFC is a technology that enables short-range wireless communication between various devices, such as mobile phones or IC tags, etc. NFC makes data communication simpler with just a touch on the designated touch-point.

- NFC (Near Field Communication) is an international standard of short-range wireless communication technology.

Note

- You can select an image size to be sent to the smartphone from [Original], [2M], or [VGA].
To change the image size, refer to the following steps.
 - For Android smartphone
Start PlayMemories Mobile, and change the image size by [Settings] → [Copy Image Size].
- RAW images are converted to JPEG format when they are sent.
- If the Image Index is displayed on the product, you cannot transfer images using the NFC function.
- If you cannot make a connection, perform the following:
 - Launch PlayMemories Mobile on your smartphone, and then move the smartphone slowly toward the  (N mark) of this product.
 - If the smartphone is in a case, remove it.
 - If the product is in a case, remove it.
 - Confirm that the NFC function is activated on the smartphone.
- When [Airplane Mode] is set to [On], you cannot connect the product and the smartphone. Set [Airplane Mode] to [Off].
- You cannot send AVCHD format movies.
- You cannot send XAVC S format movies.
- When you save images to a Mac computer using the Wi-Fi function, use “Wireless Auto Import.”

point or wireless broadband router and easily make backup copies using this operation. Before starting this operation, install PlayMemories Home on your computer and register the access point on the product.

1. Start your computer.
2. MENU →  (Wireless) → [Send to Computer].



Note

- Depending on the application settings of your computer, the product will turn off after saving the images to your computer.
- You can transfer images from the product to only one computer at a time.
- If you want to transfer images to another computer, connect the product and the computer via a USB connection and follow the instructions in PlayMemories Home.
- When you save images to the MAC computer using Wi-Fi function, use "Wireless Auto Import."

[220] How to Use | Using Wi-Fi functions | Transferring images to a TV

View on TV

You can view images on a network-enabled TV by transferring them from the product without connecting the product and TV with a cable. For some TVs, you may need to perform operations on the TV. For details, refer to the operating instructions supplied with the TV.

1. MENU →  (Wireless) → [View on TV] → desired device to be connected.
2. When you want to play back images using slideshow, press  on the center of the control wheel.

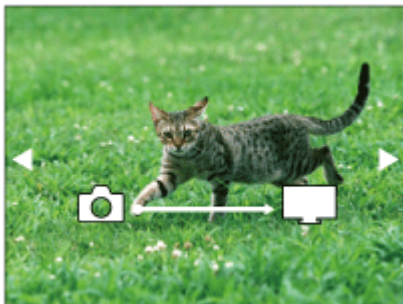

- To display the next/previous image manually, press the right/left side of the control wheel.
- To change the device to be connected, press the bottom side of the control wheel, then select [Device list].

Slideshow settings

You can change the slideshow settings by pressing the bottom side of the control wheel.

Playback Selection:

Selects the group of images to be shown.

Folder View(Still):

Selects from [All] and [All in Folder].

Date View:

Selects from [All] and [All in Date Rng.].

Interval:

Selects from [Short] and [Long].

Effects*:

Select from [On] and [Off].

Playback Image Size:

Select from [HD] and [4K].

*The settings are effective only for BRAVIA TV which is compatible with the functions.

Note

- You can use this function on a TV that supports DLNA renderer.
- You can view images on a Wi-Fi Direct-enabled TV or network-enabled TV (including wired network-enabled TVs).
- If you connect TV and this product and do not use Wi-Fi Direct, you need to register your access point first.
- Displaying the images on the TV may take time.
- Movies cannot be shown on a TV via Wi-Fi. Use an HDMI cable (sold separately).

[221] How to Use | Using Wi-Fi functions | Changing the settings of Wi-Fi functions

Airplane Mode

When you board an airplane, etc., you can temporarily disable all the wireless-related functions including Wi-Fi.

1. MENU →  (Wireless) → [Airplane Mode] → desired setting.

If you set [Airplane Mode] to [On], an airplane mark will be displayed on the screen.

[222] How to Use | Using Wi-Fi functions | Changing the settings of Wi-Fi functions

WPS Push

If your access point has the Wi-Fi Protected Setup (WPS) button, you can register the access point to this product easily by pushing the Wi-Fi Protected Setup (WPS) button.

1. MENU →  (Wireless) → [WPS Push].
2. Press the WPS button on the access point you want to register.

Note

- [WPS Push] works only if the security setting of your access point is set to WPA or WPA2 and your access point supports the Wi-Fi Protected Setup (WPS) button method. If the security setting is set to WEP or your access point does not support the Wi-Fi Protected Setup (WPS) button method, perform [Access Point Set.].
- For details about the available functions and settings of your access point, see the access point operating instructions or contact the administrator of the access point.
- A connection may not be enabled depending on the surrounding conditions, such as the type of wall material or if there is an obstruction or poor wireless signal between the product and access point. If that happens, change the location of the product or move the product closer to the access point.

[223] How to Use | Using Wi-Fi functions | Changing the settings of Wi-Fi functions

Access Point Set.

You can register your access point manually. Before starting the procedure, check the SSID name of the access point, security system, and password. The password may be preset in some devices. For details, see the access point operating instructions, or consult the access point administrator.

1. MENU →  (Wireless) → [Access Point Set.].
2. Select the access point you want to register.

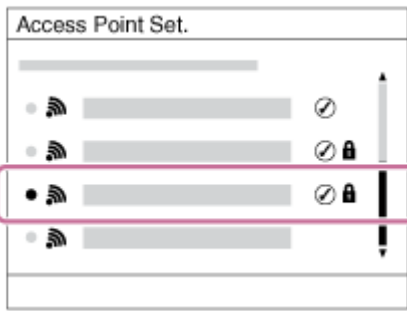

When the desired access point is displayed on the screen: Select the desired access point.

When the desired access point is not displayed on the screen: Select [Manual Setting] and set the access point.

*For the input method, refer to “How to use the keyboard.”

- If you select [Manual Setting], input the SSID name of the access point, then select the security system.

3. Input the password, and select [OK].

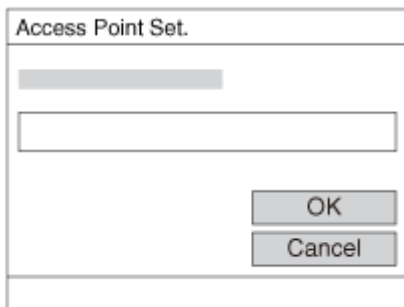

- Access points without the  mark do not require a password.

4. Select [OK].

How to use the keyboard

When manual character entry is required, a keyboard is displayed on the screen.



1. Input box

The characters you entered are displayed.

2. Switch character types

Each time you press ● in the center of the control wheel, the character type will switch between alphabet letters, numerals and symbols.

3. **Keyboard**

Each time you press ● in the center, the characters corresponding to that key will be displayed one-by-one in order.

For example: If you want to enter “abd”

Select the key for “abc” and press ● once to display “a” → select “➡” ((5) Move cursor) and press ● → select the key for “abc” and press ● twice to display “b” → select the key for “def” and press ● once to display “d”.

4. **Finalize**

Finalizes the entered characters.

5. **Move cursor**

Moves the cursor in the input box to the right or left.

6. **Delete**

Deletes the character preceding the cursor.

7. **↑**

Switches the next character to a capital or lowercase letter.

8. **└**

Enters a space.

- To cancel input, select [Cancel].

Other setting items

Depending on the status or the setting method of your access point, you may want to set more items.

WPS PIN:

Displays the PIN code you enter into the connected device.

Priority Connection:

Select [On] or [Off].

IP Address Setting:

Select [Auto] or [Manual].

IP Address:

If you are entering the IP address manually, enter the set address.

Subnet Mask/Default Gateway:

When you set [IP Address Setting] to [Manual], enter the IP address to match your network environment.

Note

- To give the registered access point priority, set [Priority Connection] to [On].

Edit Device Name

You can change the device name under Wi-Fi Direct.

1. MENU →  (Wireless) → [Edit Device Name].
2. Select the input box, then input the device name → [OK].
 - For input method, refer to "[How to use the keyboard.](#)"

Disp MAC Address

Displays the MAC address of this product.

1. MENU →  (Wireless) → [Disp MAC Address].

SSID/PW Reset

This product shares the connection information for [Send to Smartphone] and [Smart Remote Embedded] with a device that has permission to connect. If you want to change the device that is permitted to connect, reset the connection information.

1. MENU →  (Wireless) → [SSID/PW Reset] → [OK].

Note

- If you connect this product to the smartphone after resetting the connection information, you must register the smartphone again.

[227] How to Use | Using Wi-Fi functions | Changing the settings of Wi-Fi functions

Reset Network Set.

Resets all the network settings to default settings.

1. MENU →  (Wireless) → [Reset Network Set.] → [OK].

[228] How to Use | Adding applications to the product | PlayMemories Camera Apps

PlayMemories Camera Apps

You can add the desired functions to this product by connecting to the application download website  (PlayMemories Camera Apps) via the Internet.

- Press MENU →  (Application) → [Introduction] for information about the service and available countries and regions.

[229] How to Use | Adding applications to the product | PlayMemories Camera Apps

Recommended computer environment

For details on the recommended computer environments for downloading an application and adding functions to the product, refer to the following URL:

“PlayMemories Camera Apps” website (<http://www.sony.net/pmca/>)

[230] How to Use | Adding applications to the product | Installing the applications

Opening a service account

You can open a service account, which is required to download applications.

1. Access the application download website.

<http://www.sony.net/pmca/>

2. Follow the instructions on the screen and acquire a service account.
 - Follow the instructions on the screen to download the desired application to the product.

[231] How to Use | Adding applications to the product | Installing the applications

Downloading applications

You can download applications using your computer.

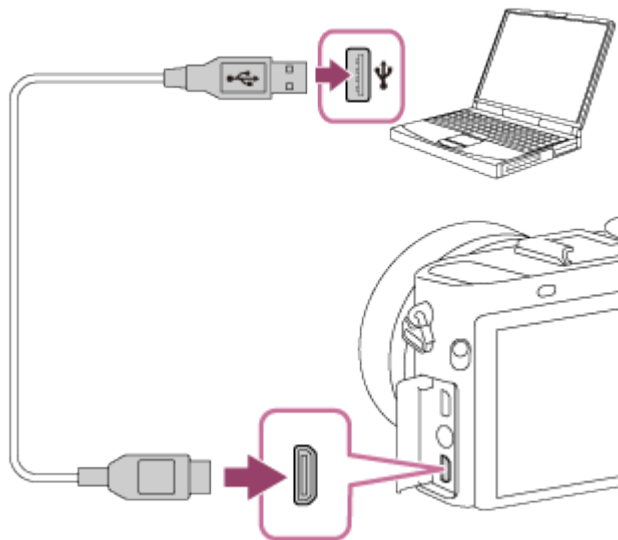

1. Access the application downloading website.
<http://www.sony.net/pmca/>
2. Select the desired application and download the application to the product following the instructions on the screen.
 - Connect the computer and the product using the micro USB cable (supplied), following the instructions on the screen.



[232] How to Use | Adding applications to the product | Installing the applications

Downloading applications directly to the product using the Wi-Fi function

You can download applications using the Wi-Fi function without connecting to a computer. Acquire a service account in advance.

1. MENU →  (Application) → [Application List] →  (PlayMemories Camera Apps), then follow the instructions on the screen to download applications.

Note

- If MENU →  (Wireless) → [Access Point Set.] → access point to be connected → [IP Address Setting] is set to [Manual], change the setting to [Auto].

[233] How to Use | Adding applications to the product | Starting the applications

Launching the downloaded application

Launch an application that has been downloaded from the application download website PlayMemories Camera Apps.

1. MENU →  (Application) → [Application List] → desired application to launch.

Hint

How to launch the applications faster

Assign [Download Appli.] and [Application List] to the custom key. You can launch the applications or display application list only by pressing the custom key during the shooting information screen is displayed.

[234] How to Use | Adding applications to the product | Managing the applications

Uninstalling applications

You can uninstall applications from this product.

1. MENU →  (Application) → [Application List] → [Application Management] → [Manage and Remove].
2. Select the application to be uninstalled.

3. Select  to uninstall the application.

- The uninstalled application can be re-installed. For details, see the application download website.

[235] How to Use | Adding applications to the product | Managing the applications

Changing the order of applications

You can change the order in which added applications are displayed on this product.

1. MENU →  (Application) → [Application List] → [Application Management] → [Sort].
2. Select the application of which you want to change the order.
3. Select the destination.

[236] How to Use | Adding applications to the product | Managing the applications

Confirming the account information of PlayMemories Camera Apps

The account information for the “Sony Entertainment Network” that is registered on the product is displayed.

1. MENU →  (Application) → [Application List] → [Application Management] → [Display Account Information].

[237] How to Use | Using a computer | Recommended computer environment

Recommended computer environment

You can confirm the operating computer environment of the software from the following

URL:

<http://www.sony.net/pcenv/>

[238] How to Use | Using a computer | Using the software

PlayMemories Home

With PlayMemories Home, you can do the following:

- You can import images shot with this product to your computer.
- You can play back the images imported to your computer.
- You can share your images using PlayMemories Online.

Also for Windows, you can do the following:

- You can organize images on the computer on a calendar by shooting date to view them.
 - You can edit and correct images, such as by trimming and resizing.
 - You can create a disc from movies imported to a computer. Blu-ray discs or AVCHD discs can be created from XAVC S-format movies.
 - You can upload images to a network service. (An internet connection is required.)
 - For other details, please refer to the Help of PlayMemories Home.
-

[239] How to Use | Using a computer | Using the software

Installing PlayMemories Home

1. Using your computer's Internet browser, go to the URL below and download PlayMemories Home by following the on-screen instructions.
<http://www.sony.net/pm/>
 - An internet connection is required.
 - For detailed instructions, visit the PlayMemories Home support page.
<http://www.sony.co.jp/pmh-se/>
2. Connect the product to your computer using the micro USB cable (supplied), then turn the product on.
 - New functions may be added to PlayMemories Home. Even if PlayMemories Home has already been installed on your computer, connect this product and your computer again.

- Do not remove the micro USB cable (supplied) from the camera while the camera is in operation or the access screen is displayed. Doing so may damage the data.

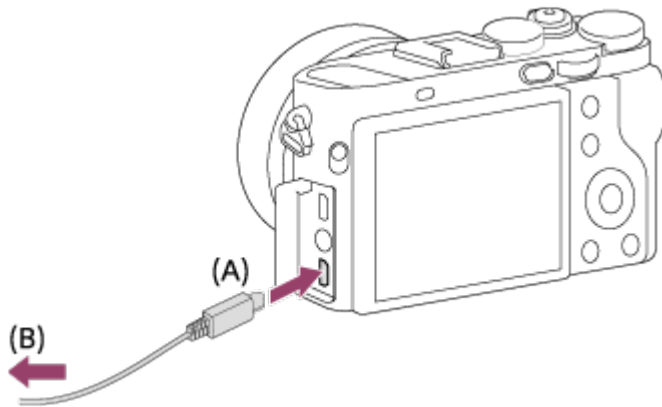

A: To the Multi/Micro USB Terminal

B: To the USB jack of the computer

Note

- Log on as Administrator.
- It may be necessary to restart your computer. When the restart confirmation message appears, restart the computer following the instructions on the screen.
- DirectX may be installed depending on your computer's system environment.

Hint

- For details on PlayMemories Home, refer to the Help of PlayMemories Home or the PlayMemories Home support page (<http://www.sony.co.jp/pmh-se/>) (English only).

[240] How to Use | Using a computer | Using the software

Software for Mac computers

For details on software for Mac computers, access the following URL:

<http://www.sony.co.jp/imsoft/Mac/>

Wireless Auto Import

“Wireless Auto Import” is required if you are using a Mac computer and want to import images to the computer using Wi-Fi function. Download “Wireless Auto Import” from the URL above, and install it on your Mac computer. For details, see Help for “Wireless Auto Import.”

Note

- The software that can be used varies depending on the region.

Image Data Converter

With Image Data Converter, you can do the following:

- You can play back and edit images recorded in RAW format with various corrections, such as tone curve and sharpness.
- You can adjust images with white balance, exposure, and [Creative Style], etc.
- You can save the still images displayed and edited on a computer.
You can either save the still image as RAW format or save it in the general file format.
- You can display and compare the RAW images and JPEG images recorded by this product.
- You can rank images in five grades.
- You can apply color labels.

Installing Image Data Converter

1. Download and install the software by accessing the following URL (English only).
<http://www.sony.co.jp/ids-se/>

Note

- Log on as Administrator.

Accessing Image Data Converter Guide

Windows:

[Start] → [All Programs] → [Image Data Converter] → [Help] → [Image Data Converter].

- For Windows 8, start [Image Data Converter], and select [Help] from the menu bar → [Image Data Converter Guide].

Mac:

Finder → [Applications] → [Image Data Converter] → [Image Data Converter], and select

[Help] from the menu bar → [Image Data Converter Guide].

Hint

- For details on operation, you can also refer to the Image Data Converter support page (English only).

<http://www.sony.co.jp/ids-se/>

[244] How to Use | Using a computer | Using the software

Remote Camera Control

When using Remote Camera Control, the following operations are available on your computer.

- Changing this product's settings and shooting.
- Recording images directly to the computer.
- Performing interval timer shooting.

Use these functions after selecting MENU →  (Setup) → [USB Connection] → [PC Remote]. For details on how to use Remote Camera Control, refer to the Help.

[245] How to Use | Using a computer | Using the software

Installing Remote Camera Control

Download and install the software by accessing the following URL:

Windows:

<http://www.sony.co.jp/imsoft/Win/>

Mac:

<http://www.sony.co.jp/imsoft/Mac/>

[246] How to Use | Using a computer | Using the software

Accessing the Help of Remote Camera Control

Windows:

[Start] → [All Programs] → [Remote Camera Control] → [Remote Camera Control Help].

- For Windows 8, start [Remote Camera Control], and right-click the title bar to select

[Remote Camera Control Help].

Mac:

Finder → [Applications] → [Remote Camera Control], and select [Help] from the menu bar → [Remote Camera Control Help].

[247] How to Use | Using a computer | Connecting this product and a computer

Connecting the product to a computer

1. Insert a sufficiently charged battery pack into the product.
2. Turn on the product and the computer.
3. Check from  (Setup) that [USB Connection] is set to [Mass Storage].
4. Connect the product and your computer using the micro USB cable (supplied) **(A)** .

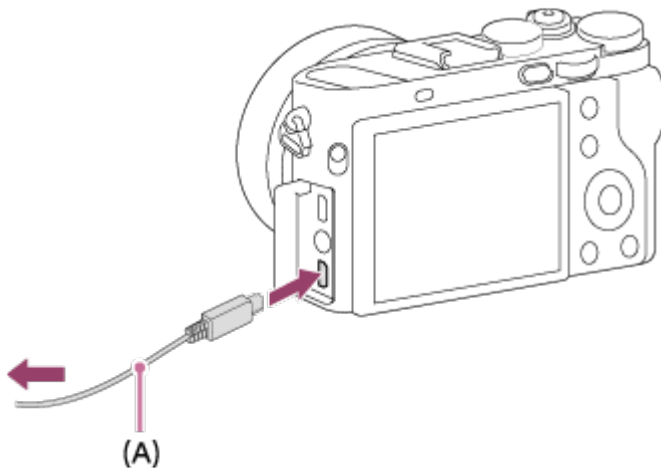

- If you connect the product to your computer using the micro USB cable when [USB Power Supply] is set to [On], power is supplied from your computer. (Default setting: [On])

[248] How to Use | Using a computer | Connecting this product and a computer

Importing images to the computer

PlayMemories Home allows you to easily import images. For details on PlayMemories Home functions, see the Help of PlayMemories Home.

Importing images to the computer without using PlayMemories

Home (For Windows)

When the AutoPlay Wizard appears after making a USB connection between this product and a computer, click [Open folder to view files] → [OK] → [DCIM] or [MP_ROOT]. Then copy the desired images to the computer.

- If Device Stage appears on a Windows 7 or Windows 8 computer, double-click [Browse Files] → media icon → folder in which the images you want to import are stored.

Importing images to the computer without using PlayMemories Home (For Mac)

Connect the product to your Mac computer. Double-click the newly recognized icon on the desktop → the folder in which the image you want to import is stored. Then drag and drop the image file on to the hard disk icon.

Note

- For operations such as importing XAVC S movies or AVCHD movies to the computer, use PlayMemories Home.
- Do not edit or otherwise process AVCHD movie files/folders from the connected computer. Movie files may be damaged or become unplayable. Do not delete or copy AVCHD movies on the memory card from the computer. Sony is not held liable for consequences resulting from such operations via the computer.

[249] How to Use | Using a computer | Connecting this product and a computer

Disconnecting the product from the computer

Disconnects the USB connection between this product and the computer.

Perform the procedures from step 1 to 2 below before performing the following operations:

- Disconnecting the USB cable.
- Removing a memory card.
- Turning off the product.

1. Click  (Safely remove USB Mass Storage Device) on the taskbar.
2. Click the displayed message.

Note

- For Mac computers, drag and drop the icon of the memory card or the drive icon in the “Trash” icon. The product is disconnected from the computer.
- For Windows 7/Windows 8 computers, the disconnect icon may not appear. In that case,

you can skip steps 1 and 2 above.

- Do not remove a micro USB cable from this product while the access lamp is illuminated. The data may be damaged.

[250] How to Use | Using a computer | Creating a movie disc

Selecting a disc to be created

You can create a disc that can be played back on other devices from a movie recorded on this camera.

What devices can play back the disc depends on the disc type. Select a disc type suitable for the playback devices you will be using.

Depending on the movie type, the movie format may be converted when creating a disc.



High-definition image quality (HD) (Blu-ray Disc)

High-definition image quality (HD) movies can be recorded on a Blu-ray Disc, creating a high-definition image quality (HD) disc. A Blu-ray Disc enables you to record longer-duration high-definition image quality (HD) movies than DVD discs.

Writable movie formats: XAVC S, AVCHD, MP4 (AVC)

Players: Blu-ray Disc playback devices (Sony Blu-ray Disc players, PlayStation 3, etc.)



High-definition image quality (HD) (AVCHD recording disc)

High-definition image quality (HD) movies can be recorded on DVD media such as DVD-R discs, creating a high-definition image quality (HD) disc.

Writable movie formats: XAVC S, AVCHD, MP4 (AVC)

Players: AVCHD format playback devices (Sony Blu-ray Disc players, PlayStation 3, etc.)

You cannot play these kinds of discs on ordinary DVD players.



Standard definition image quality (STD)

Standard definition image quality (STD) movies converted from high-definition image quality (HD) movies can be recorded on DVD media such as DVD-R discs, creating a standard image quality (STD) disc.

Writable movie format: AVCHD

Players: Ordinary DVD playback devices (DVD players, computers that can play back DVD)

discs, etc.)

Hint

- You can use the following types of 12 cm discs with PlayMemories Home.
BD-R*/ DVD-R/DVD+R/DVD+R DL: Non-rewritable
BD-RE*/DVD-RW/DVD+RW: Rewritable
- * Additional recording is not possible.
- Always maintain your “PlayStation 3” to use the latest version of the “PlayStation 3” system software.

[251] How to Use | Using a computer | Creating a movie disc

Creating Blu-ray Discs from high-definition image quality movies

You can create Blu-ray Discs that can be played back on Blu-ray Disc playback devices (such as Sony Blu-ray Disc players or the PlayStation 3, etc.).

A. How to create using a computer

With a Windows computer, you can copy movies imported to the computer and create Blu-ray Discs using PlayMemories Home.

Your computer must be able to create Blu-ray Discs.

When you create a Blu-ray Disc for the first time, connect your camera to the computer using a USB cable. The necessary software is automatically added to your computer. (An internet connection is needed.)

For details on how to create a disc using PlayMemories Home, refer to the Help guide for PlayMemories Home.

B. How to create using a device other than a computer

You can also create Blu-ray Discs using a Blu-ray recorder, etc.

For details, refer to the device's operating instructions.

Note

- When creating Blu-ray discs using PlayMemories Home from movies recorded in the XAVC S or MP4 movie formats, the image quality is converted to 1920×1080 (60i/50i) and it is not possible to create discs with the original image quality. To record movies with the original image quality, copy movies to a computer or an external medium.
- To create a Blu-ray Disc from movies recorded in the AVCHD movie format with [ Record Setting] set to [60p 28M(PS)]/[50p 28M(PS)], you need to use a device that is compliant with AVCHD format Ver. 2.0. The created Blu-ray Disc can be played back only on a device that is compliant with AVCHD format Ver. 2.0.

Creating DVD discs (AVCHD recording discs) from high-definition image quality movies

You can create DVD discs (AVCHD recording discs) that can be played back on AVCHD-compatible playback devices (such as Sony Blu-ray Disc players or the PlayStation 3, etc.).

A. How to create using a computer

With a Windows computer, you can copy movies imported to the computer and create DVD discs (AVCHD recording discs) using PlayMemories Home.

Your computer must be able to create DVD discs (AVCHD recording discs).

When you create a DVD disc for the first time, connect your camera to the computer using a USB cable. The necessary software is automatically added to your computer. (An internet connection is needed.)

For details on how to create a disc using PlayMemories Home, refer to the Help guide for PlayMemories Home.

B. How to create using a device other than a computer

You can also create DVD discs (AVCHD recording discs) using a Blu-ray recorder, etc.

For details, refer to the device's operating instructions.

Note

- When creating DVD discs (AVCHD recording discs) using PlayMemories Home from movies recorded in the XAVC S or MP4 movie formats, the image quality is converted to 1920×1080 (60i/50i) and it is not possible to create discs with the original image quality. To record movies with the original image quality, copy movies to a computer or an external medium.
- When creating AVCHD recording discs using PlayMemories Home from movies recorded in the AVCHD movie format with [ Record Setting] set to [60p 28M(PS)]/[50p 28M(PS)], [60i 24M(FX)]/[50i 24M(FX)] or [24p 24M(FX)]/[25p 24M(FX)], the image quality is converted and it is not possible to create discs with the original image quality. Converting the image quality takes time. To record movies with the original image quality, use a Blu-ray Disc.

Creating DVD discs from standard image quality movies

You can create DVD discs that can be played back on ordinary DVD playback devices (DVD players, computers that can play back DVD discs, etc.).

A. How to create using a computer

With a Windows computer, you can copy movies imported to the computer and create DVD disc using PlayMemories Home.

Your computer must be able to create DVD discs.

When you create a DVD disc for the first time, connect your camera to the computer using a USB cable. Install the dedicated add-on software following the on-screen instructions. (An internet connection is needed.)

For details on how to create a disc using PlayMemories Home, refer to the Help for PlayMemories Home.

B. How to create using a device other than a computer

You can also create DVD discs using a Blu-ray recorder, HDD recorder, etc. For details, refer to the device's operating instructions.

[254] How to Use | Precautions/This product | Precautions

Precautions

Backing up memory cards

Data may be corrupted in the following cases. Be sure to back up the data for protection.

- When the memory card is removed, the USB cable is disconnected, or the product is turned off in the middle of a read or write operation.
- When the memory card is used in locations subject to static electricity or electrical noise.

Creating an image database file

If you insert a memory card that does not contain an image database file into the product and turn on the power, the product automatically creates an image database file using some of the memory card's capacity. The process may take a long time and you cannot operate the product until the process is completed.

If a database file error occurs, export all images to your computer using PlayMemories Home, and then format the memory card using this product.

Do not use/store the product in the following places

- In an extremely hot, cold or humid place
In places such as in a car parked in the sun, the camera body may become deformed and this may cause a malfunction.
- Storing under direct sunlight or near a heater

The camera body may become discolored or deformed, and this may cause a malfunction.

- In a location subject to rocking vibration
- Near strong magnetic place
- In sandy or dusty places

Be careful not to let sand or dust get into the product. This may cause the product to malfunction, and in some cases this malfunction cannot be repaired.

On storing

Always attach the lens front cap when you are not using the camera.

Precaution on carrying

Do not carry the camera with the tripod attached. This may cause the tripod socket hole to break.

On operating temperatures

Your product is designed for use under the temperatures between approximately 0°C and 40°C (32 °F and 104 °F). Shooting in extremely cold or hot places that exceed this range is not recommended.

On moisture condensation

- If the product is brought directly from a cold to a warm location, moisture may condense inside or outside the product. This moisture condensation may cause a malfunction of the product.
- To prevent moisture condensation when you bring the product directly from a cold to a warm location, first put it in a plastic bag and seal it to prevent air from entering. Wait for about an hour until the temperature of the product has reached the ambient temperature.
- If moisture condensation occurs, turn off the product and wait about an hour for the moisture to evaporate. Note that if you attempt to shoot with moisture remaining inside the lens, you will be unable to record clear images.

On the functions available with the product

- This camera is compatible with 1080 60p or 1080 50p-format movies. Unlike traditional standard recording modes, which record using an interlacing method, this product records movies using a progressive method. This increases the resolution, and provides a smoother, more realistic image.

Notes for when on board an airplane

- In an airplane, set [Airplane Mode] to [On].

On image data compatibility

This product conforms with DCF (Design rule for Camera File system) universal standard established by JEITA (Japan Electronics and Information Technology Industries Association).

- Playback of images recorded with your product on other equipment and playback of images recorded or edited with other equipment on your product are not guaranteed.

Notes on playing movies on other devices

- Movies recorded by your camera may not be playable properly on other devices. Also, movies recorded by devices other than your camera may not be able to playback on your camera.
- Discs of AVCHD movies recorded by your camera can only be played back on devices supporting AVCHD format.
DVD players and DVD recorders do not support AVCHD format, so they cannot playback AVCHD movie discs.
Also, if a high definition image quality (HD) disc recorded with AVCHD format is inserted in either of DVD players or DVD recorders, the disc may be unable to eject from the device.
- Movies recorded in 1080 60p/1080 50p format can be played back only on 1080 60p/1080 50p supported devices.
- XAVC S movies can be played back only on XAVC S-supported devices.

On the monitor, viewfinder, and lens

- The monitor and viewfinder are manufactured using extremely high-precision technology so over 99.99 % of the pixels are operational for effective use. However, there may be some tiny black points and/or bright points (white, red, blue or green in color) that consistently appear on the monitor and the viewfinder. These points are normal in the manufacturing process and do not affect the images in any way.
- Exposing the monitor or lens to direct sunlight for long periods may cause a malfunction. Exercise caution when placing the product near a window or outdoors.
- Do not press against the monitor. The monitor may be discolored and that may cause a malfunction.
- Images may trail across on the monitor in a cold location. This is not a malfunction.
- If the monitor has drops of water or other liquids on it, wipe it with a soft cloth. If the monitor stays wet, the surface of the monitor may change or deteriorate. This may cause a malfunction.
- Make sure not to bump the lens or subject it to force.
- Do not hold the camera by the monitor or viewfinder.
- When pushing down the viewfinder, be careful not to catch your fingers in the viewfinder.
- Do not force down the viewfinder when the eye piece is pulled out.
- If water, sand, or dust adheres to the viewfinder, it may cause a malfunction.
- Do not expose the camera to sunlight or shoot sunward for a long time. The internal mechanism may be damaged.

- Do not use the camera in areas where strong radio waves or radiation is being emitted. Recording and playback may not function correctly.
- Magnets **(A)** are attached to the camera body and the back of the monitor. Do not insert any magnetically recorded media, such as floppy disks or credit cards between them.

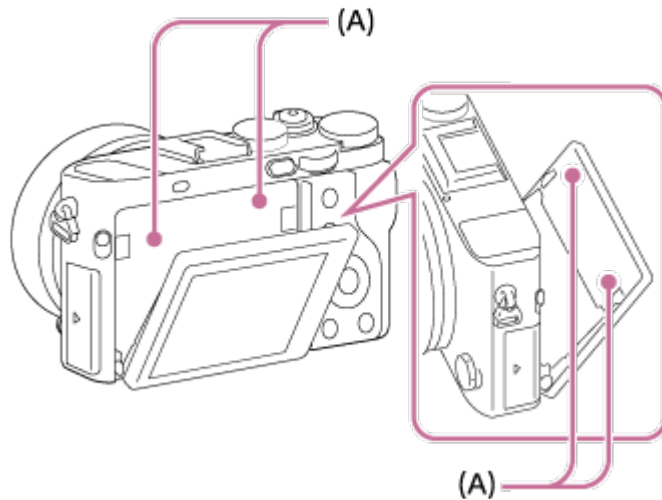

Shooting with the viewfinder

- When looking through the viewfinder, you may experience symptoms such as eye soreness, fatigue, or nausea similar to car-sickness. We recommend that you take periodic breaks when shooting with the viewfinder. Determine the necessary length and frequency of breaks on your own, as these will vary from individual to individual. If unpleasant symptoms occur, stop using the viewfinder until they resolve, and consult your doctor if necessary.

Notes on discarding or transferring this product to others

When discarding or transferring this product to others, make sure to perform the following operation to protect private information.

- Perform [Setting Reset] to reset all the settings.

[255] How to Use | Precautions/This product | Precautions

On the internal rechargeable battery

This camera has an internal rechargeable battery for maintaining the date and time and other settings regardless of whether the power is on or off, or whether the battery pack is charged or discharged. This rechargeable battery is continually charged as long as you are using the product. However, if you use the product for only short periods, it gradually

discharges. If you do not use the product at all for about 3 month(s) it becomes completely discharged. In this case, be sure to charge this rechargeable battery before using the product. However, even if this rechargeable battery is not charged, you can still use the product as long as you do not record the date and time.

Charging method of the internal rechargeable battery

Insert a charged battery pack into the product, or connect the product to a wall outlet (wall socket) using the AC Adaptor (supplied), and leave the product for 24 hours or more with the power off.

[256] How to Use | Precautions/This product | Precautions

Notes on the battery pack

Charging the battery pack

- Charge the battery pack (supplied) before using the product for the first time.
- The charged battery pack will discharge little by little even if you do not use it. Charge the battery pack each time before you use the product so that you do not miss any opportunities to shoot images.
- You can charge the battery pack even if it is not completely discharged. You can use a partially charged battery pack.
- If the charge lamp flashes when the battery pack is not fully charged, remove the battery pack or disconnect the USB cable from the camera and then reinsert it to recharge.
- We recommend charging the battery pack in an ambient temperature of between 10 °C and 30 °C (50 °F and 86 °F). The battery pack may not be effectively charged in temperatures outside this range.
- When you connect this product and a laptop computer that is not connected to a power source, the laptop's battery charge may decrease. Do not charge this product using the laptop computer for too long.
- Do not turn on/restart a computer, wake a computer from sleep mode, or turn off a computer while this product is connected to the computer via USB cable. Doing so may cause a malfunction of this product. Disconnect the product and the computer before performing the above operations.
- We do not guarantee charging if you are using a self-built or modified computer.

Charging time (Full charge)

The charging time is approximately 155 min. using the AC Adaptor (supplied) with the battery charger (supplied), and approximately 150 min. using the AC Adaptor with the camera. The above charging time applies when charging a fully depleted battery pack at a temperature of 25 °C (77 °F). Charging may take longer depending on conditions of use and

circumstances.

Effective use of the battery pack

- Battery performance decreases in low temperature environments. So in cold places, the operational time of the battery pack is shorter. To ensure longer battery pack use, we recommend putting the battery pack in your pocket close to your body to warm it up, and insert it in the product immediately before you start shooting. If there are any metal objects such as keys in your pocket, be careful of causing a short-circuit.
- The battery pack will run down quickly if you use the flash or continuous shooting function frequently, turn the power on/off frequently, or set the monitor very bright.
- We recommend preparing spare battery packs and taking trial shots before taking the actual shots.
- Do not expose the battery pack to water. The battery pack is not water-resistant.
- Do not leave the battery pack in extremely hot places, such as in a car or under direct sunlight.
- If the battery terminal is dirty, you may not be able to turn on the product or the battery pack may not be properly charged. In that case, clean the battery by lightly wiping off any dust using a soft cloth or a cotton swab.

Remaining battery indicator

- The remaining battery indicator appears on the screen.



A: Battery level high

B: Battery exhausted

- It takes about one minute for the correct remaining battery indicator to appear.
- The correct remaining battery indicator may not be displayed under some operating or environmental conditions.
- If the remaining battery time does not appear on the screen, press the DISP (Display Setting) button to display it.

How to store the battery pack

- To maintain the battery pack's function, charge the battery pack and then fully discharge it in the product at least once a year before storing it. Remove the battery pack from the camera and store the battery in a cool, dry place.
- To use the battery pack up, leave the product in slide show playback mode until the power goes off.
- To prevent staining the terminal, short-circuiting, etc., be sure to use a plastic bag to keep away from metal materials when carrying or storing the battery pack.

On battery life

- The battery life is limited. If you use the same battery repeatedly, or use the same battery for a long period, the battery capacity decreases gradually. If the available time of the battery is shortened significantly, it is probably time to replace the battery pack with a new one.
- The battery life varies according to how the battery pack is stored and the operating conditions and environment in which each battery pack is used.

[257] How to Use | Precautions/This product | Precautions

Charging the battery pack

- The supplied AC Adaptor is dedicated to this product. Do not connect with other electronic devices. Doing so may cause a malfunction.
- Make sure to use a genuine Sony AC Adaptor.
- If the product's charge lamp flashes while charging, remove the battery pack being charged, and then insert the same battery pack firmly back into the product. If the charge lamp flashes again, this may indicate a faulty battery or that a battery pack other than the specified type has been inserted. Check that the battery pack is the specified type. If the battery pack is the specified type, remove the battery pack, replace it with a new or different one and check that the newly inserted battery is charging correctly. If the newly inserted battery is charging correctly, the previously inserted battery may be faulty.
- If the charge lamp flashes even if the AC Adaptor is connected to the product and the wall outlet (wall socket), this indicates that charging has stopped temporarily and is on standby. Charging stops and enters standby status automatically when the temperature is outside of the recommended operating temperature. When the temperature returns to the appropriate range, charging resumes and the charge lamp lights up again. We recommend charging the battery pack in an ambient temperature of between 10°C to 30°C (50°F to 86°F).

[258] How to Use | Precautions/This product | Precautions

Notes on memory card

- If you repeatedly shoot and delete images for a long time, fragmentation of data in a file in the memory card may occur, and movie recording may be interrupted in the middle of

shooting. If this happens, save your images to a computer or other storage location, then execute [Format].

- Memory card formatted with a computer is not guaranteed to operate with the product.
- Data read/write speeds differ depending on the combination of the memory card and the equipment used.
- We recommend backing up important data, such as to a hard disk of a computer.
- Do not attach a label on the memory card itself nor on a memory card adaptor.
- Do not touch the terminal section of the memory card with your hand or a metal object.
- Do not strike, bend or drop the memory card.
- Do not disassemble or modify the memory card.
- Do not expose the memory card to water.
- Do not leave the memory card within the reach of small children. They might accidentally swallow it.
- The memory card may be hot just after it has been used for a long time. Be careful when you handle it.
- Do not remove the battery pack or the memory card or turn the camera off while the access lamp is illuminated. This may cause the data on the memory card to become damaged.
- If the memory card is used near areas with strong magnetization, or used in locations subject to static electricity or electrical noise, the data on the memory card may become damaged.
- Do not insert a memory card that does not fit the memory card slot. Doing so will cause a malfunction.
- Do not use or store the memory card under the following conditions:
 - High temperature locations such as in a car parked under the sun
 - Locations exposed to direct sunlight
 - Humid locations or locations with corrosive substances present
- To use a Memory Stick Micro media with this product, be sure to insert the Memory Stick Micro media into an M2 Adaptor as large as Duo size. If you insert a Memory Stick Micro media into the product without an M2 Adaptor as large as Duo size, you might not be able to remove it from the product.
- To use a microSD memory card with this product, be sure to insert the microSD memory card into a dedicated adaptor.
- When inserting a memory card into a memory card adaptor, be sure that the memory card is inserted in the correct direction and then insert it as far as it will go. If the card is not inserted properly, it may result in a malfunction.

Cleaning the lens

- Do not use a cleaning solution containing organic solvents, such as thinner, or benzine.
- When cleaning the lens surface, remove dust with a commercially available blower. In case of dust that sticks to the surface, wipe it off with a soft cloth or tissue paper slightly moistened with lens cleaning solution. Wipe in a spiral pattern from the center to the outside. Do not spray lens cleaning solution directly onto the lens surface.

Cleaning the product surface

Clean the product surface with a soft cloth slightly moistened with water, then wipe the surface with a dry cloth. To prevent damage to the finish or casing:

- Do not expose the product to chemical products such as thinner, benzine, alcohol, disposable cloths, insect repellent, sunscreen or insecticide.
- Do not touch the product with any of the above on your hand.
- Do not leave the product in contact with rubber or vinyl for a long time.

Cleaning the monitor

- If oil from your hand or hand cream, etc., remain on the monitor, the original coating may become easily removable. Wipe oil or hand cream off as soon as possible.
- If you wipe the monitor firmly using tissue paper, etc., the coating may be scratched.
- If the monitor becomes dirty with fingerprints or dust, gently remove the dust from the surface, and then clean the monitor using soft cloth, etc.

[260] How to Use | Precautions/This product | Number of recordable still images and recordable time of movies

Number of still images

The number of still images may vary depending on the shooting conditions and the memory card.

[ Image Size]: [L: 42M]

When [ Aspect Ratio] is set to [3:2]*

Standard

8 GB: 770 images

16 GB: 1550 images

32 GB: 3100 images

64 GB: 6200 images

Fine

8 GB: 520 images

16 GB: 1000 images

32 GB: 2100 images

64 GB: 4200 images

Extra fine

8 GB: 270 images

16 GB: 540 images

32 GB: 1050 images

64 GB: 2150 images

RAW & JPEG (Compressed RAW)

8 GB: 130 images

16 GB: 260 images

32 GB: 520 images

64 GB: 1050 images

RAW (Compressed RAW)

8 GB: 170 images

16 GB: 350 images

32 GB: 700 images

64 GB: 1400 images

RAW & JPEG (Uncompressed RAW)

8 GB: 75 images

16 GB: 150 images

32 GB: 300 images

64 GB: 600 images



RAW (Uncompressed RAW)

8 GB: 88 images

16 GB: 175 images

32 GB: 355 images

64 GB: 710 images

*When the [ Aspect Ratio] is set to other than [3:2], you can record more pictures than shown above. (Except when [ Quality] is set to [RAW].)

Note

- Even if the number of remaining shootable images is greater than 9,999, the “9999” indicator appears.
- When an image shot with other products is played back on this product, the image may not appear in the actual image size.

The table below shows the approximate maximum recording times which can be recorded on the memory card that is formatted with this product. These numbers are the total times of all movie files on the memory card. The recordable time may vary depending on the shooting conditions and the memory card.

The values when [ File Format] is set to [XAVC S HD] and [AVCHD] are based on shooting with [Dual Video REC] set to [Off].

(h (hour), m (minute))

[File Format]: [XAVC S HD]

60p 50M

50p 50M

8 GB: -

16 GB: -

32 GB: -

64 GB: 2 h 35 m

30p 50M

25p 50M

8 GB: -

16 GB: -

32 GB: -

64 GB: 2 h 35 m

24p 50M*

8 GB: -

16 GB: -

32 GB: -

64 GB: 2 h 35 m

120p 50M

100p 50M

8 GB: -

16 GB: -

32 GB: -

64 GB: 2 h 35 m

[File Format]: [AVCHD]

60i 24M(FX)

50i 24M(FX)

8 GB: 40 m

16 GB: 1 h 25 m

32 GB: 3 h

64 GB: 6 h

60i 17M(FH)

50i 17M(FH)

8 GB: 55 m
16 GB: 2 h
32 GB: 4 h 5 m
64 GB: 8 h 15 m

60p 28M(PS)

50p 28M(PS)

8 GB: 35 m
16 GB: 1 h 15 m
32 GB: 2 h 30 m
64 GB: 5 h 5 m

24p 24M(FX)

25p 24M(FX)

8 GB: 40 m
16 GB: 1 h 25 m
32 GB: 3 h
64 GB: 6 h

24p 17M(FH)

25p 17M(FH)

8 GB: 55 m
16 GB: 2 h
32 GB: 4 h 5 m
64 GB: 8 h 15 m

[ File Format]: [MP4]

1920x1080 60p 28M

1920x1080 50p 28M

8 GB: 35 m
16 GB: 1 h 15 m
32 GB: 2 h 35 m
64 GB: 5 h 20 m

1920x1080 30p 16M

1920x1080 25p 16M

8 GB: 1 h
16 GB: 2 h
32 GB: 4 h 10 m
64 GB: 8 h 25 m

1280x720 30p 6M

1280x720 25p 6M

8 GB: 2 h 35 m
16 GB: 5 h 20 m
32 GB: 10 h 55 m
64 GB: 22 h

*Only when [NTSC/PAL Selector] is set to NTSC.

([NTSC/PAL Selector] is only available for models that have AVCHD 50i recording as a default

setting.)

When using the camera's default settings, continuous shooting is possible for approximately 29 minutes (max.) for each shooting at a temperature of approximately 25°C (77°F).

However, the recording time is approximately 5 minutes when shooting movies in XAVC S HD 120p/100p format.

(a product specification limit)

If the file format is set to MP4 (28M), continuous shooting is possible for approximately 20 minutes for each shooting (limited by file size of 4 GB).

Note

- The recordable time of movies varies because the product is equipped with VBR (Variable Bit-Rate), which automatically adjusts image quality depending on the shooting scene. When you record a fast-moving subject, the image is clearer but the recordable time is shorter because more memory is required for recording. The recordable time also varies depending on the shooting conditions, the subject or the image quality/size settings.

Notes on continuous movie recording

- It requires a lot of power to perform high quality movie recording or continuous shooting using the image sensor. Therefore, if you continue to shoot, the temperature inside the camera will rise, especially that of the image sensor. In such cases, the camera turns off automatically since higher temperatures affect the quality of the images or affect the internal mechanism of the camera.
- The duration of time available for movie recording varies with the temperature, the recording format/setting, or condition of the camera before you start recording. If you frequently recompose or shoot images after the power is turned on, the temperature inside the camera will rise and the recording time available will be shorter.
- When  is indicated, stop recording the movie.
- If the camera stops recording due to the temperature, leave it for several minutes with the power turned off. Start recording after the temperature inside the camera drops fully.

[262] How to Use | Precautions/This product | Using this product abroad

Plug adaptor

You can use the AC Adaptor (supplied) in any country or region where the power supply is within 100 V to 240 V AC and 50 Hz/60 Hz.

Note

- Do not use an electronic voltage transformer as doing so may cause a malfunction.

On TV color systems

To view movies shot using this product on a television, the product and television must use the same color television system. Check the TV color system for the country or region where you are using the product.

- **NTSC system:**

Bahama Islands, Bolivia, Canada, Central America, Chile, Colombia, Ecuador, Jamaica, Japan, Korea, Mexico, Peru, Surinam, Taiwan, the Philippines, the U.S.A., Venezuela, etc.

- **PAL system:**

Australia, Austria, Belgium, China, Croatia, Czech Republic, Denmark, Finland, Germany, Holland, Hong Kong, Hungary, Indonesia, Italy, Kuwait, Malaysia, New Zealand, Norway, Poland, Portugal, Rumania, Singapore, Slovak Republic, Spain, Sweden, Switzerland, Thailand, Turkey, United Kingdom, Viet Nam, etc.

- **PAL-M system:**

Brazil

- **PAL-N system:**

Argentina, Paraguay, Uruguay

- **SECAM system:**

Bulgaria, France, Greece, Guiana, Iran, Iraq, Monaco, Russia, Ukraine, etc.

ZEISS lens

The camera is equipped with a ZEISS lens which is capable of reproducing sharp images with excellent contrast. The lens for the camera has been produced under a quality assurance system certified by ZEISS in accordance with the quality standards of ZEISS in Germany.

AVCHD format

The AVCHD format was developed for high-definition digital video cameras when recording

an HD (High-Definition) signal using high-efficiency compression coding technology. The MPEG-4 AVC/H.264 format is used to compress video data, and the Dolby Digital or Linear PCM system is used to compress audio data.

The MPEG-4 AVC/H.264 format is capable of compressing images at higher efficiency than that of the conventional image compressing format.

- As the AVCHD format uses compression coding technology, the picture may be unstable in scenes where the screen, angle of view, or brightness, etc. change drastically, but this is not a malfunction.

[266] How to Use | Precautions/This product | Other information

License

Notes on the License

This product comes with software that are used based on licensing agreements with the owners of that software. Based on requests by the owners of copyright of these software applications, we have an obligation to inform you of the following. Please read the following sections. Licenses (in English) are recorded in the internal memory of your product. Establish a Mass Storage connection between the product and a computer to read licenses in the “PMHOME” - “LICENSE” folder.

THIS PRODUCT IS LICENSED UNDER THE AVC PATENT PORTFOLIO LICENSE FOR THE PERSONAL USE OF A CONSUMER OR OTHER USES IN WHICH IT DOES NOT RECEIVE REMUNERATION TO

(i) ENCODE VIDEO IN COMPLIANCE WITH THE AVC STANDARD (“AVC VIDEO”) AND/OR

(ii) DECODE AVC VIDEO THAT WAS ENCODED BY A CONSUMER ENGAGED IN A PERSONAL ACTIVITY AND/OR WAS OBTAINED FROM A VIDEO PROVIDER LICENSED TO PROVIDE AVC VIDEO.

NO LICENSE IS GRANTED OR SHALL BE IMPLIED FOR ANY OTHER USE. ADDITIONAL INFORMATION MAY BE OBTAINED FROM MPEG LA, L.L.C. SEE

[HTTP://WWW.MPEGLA.COM](http://www.mpegla.com)

On GNU GPL/LGPL applied software

The software that is eligible for the following GNU General Public License (hereinafter referred to as “GPL”) or GNU Lesser General Public License (hereinafter referred to as “LGPL”) are included in the product.

This informs you that you have a right to have access to, modify, and redistribute source code for these software programs under the conditions of the supplied GPL/LGPL.



Source code is provided on the web. Use the following URL to download it.

<http://oss.sony.net/Products/Linux/>

We would prefer you do not contact us about the contents of source code.

[267] How to Use | Precautions/This product | Trademarks

Trademarks

- The following marks are registered trademarks or trademarks of Sony Corporation.
Cyber-shot, Cyber-shot, , Memory Stick, **MEMORY STICK PRO**, Memory Stick PRO, **MEMORY STICK DUO**, Memory Stick Duo, **MEMORY STICK PRO DUO**, Memory Stick PRO Duo, **MEMORY STICK PRO-HG DUO**, Memory Stick PRO-HG Duo, **MEMORY STICK MICRO**, Memory Stick Micro, **MAGIC GATE**, MagicGate, BRAVIA, PhotoTV HD, PlayMemories Online, PlayMemories Online logo, PlayMemories Home, PlayMemories Home logo, PlayMemories Mobile, PlayMemories Mobile logo
PlayMemories Camera Apps, PlayMemories Camera Apps logo
Multi Interface Shoe, Multi Interface Shoe logo
- XAVC S and  are registered trademarks of Sony Corporation.
- Blu-ray Disc™ and Blu-ray™ are trademarks of the Blu-ray Disc Association.
- AVCHD Progressive and AVCHD Progressive logotype are trademarks of Panasonic Corporation and Sony Corporation.
- Dolby and the double-D symbol are trademarks of Dolby Laboratories.
- HDMI, the HDMI logo and High-Definition Multimedia Interface are trademarks or registered trademarks of HDMI Licensing LLC.
- Microsoft, Windows and DirectX are either registered trademarks or trademarks of Microsoft Corporation in the United States and/or other countries.
- Mac is a trademark of Apple Inc.
- iPhone and iPad are trademarks of Apple Inc., registered in the U.S. and other countries.
- SDXC logo is a trademark of SD-3C, LLC.
- Android and Google Play are trademarks or registered trademarks of Google Inc.
- Wi-Fi, the Wi-Fi logo, Wi-Fi Protected Setup are registered trademarks or trademarks of the Wi-Fi Alliance.
- The N Mark is a trademark or registered trademark of NFC Forum, Inc. in the United States and in other countries.
- DLNA and DLNA CERTIFIED are trademarks of Digital Living Network Alliance.

- Eye-Fi is a trademark of Eye-Fi Inc.
- In addition, system and product names used in this manual are, in general, trademarks or registered trademarks of their respective developers or manufacturers. However, the ™ or ® marks may not be specified in all cases in this manual.

[268] Troubleshooting | If you have problems | If you have problems

Troubleshooting

If you experience trouble with the product, try the following solutions.

1. Check the items under “Troubleshooting”, then check the product.
If a message such as “C/E:□□:□□” appears on the screen, refer to the self-diagnosis display.
2. Remove the battery pack, wait for about one minute, re-insert the battery pack, then turn on the power.
3. Initialize the settings.
4. Consult your dealer or local authorized service facility. Additional information on this product and answers to frequently asked questions can be found at our Customer Support Website.
<http://www.sony.net/>

[269] Troubleshooting | Troubleshooting | Battery pack and power

You cannot insert the battery pack into the product.

- Make sure the direction of the battery pack is correct, and insert it until the battery lock lever is locked.
- Make sure that the battery is NP-BX1.

[270] Troubleshooting | Troubleshooting | Battery pack and power

You cannot turn on the product.

-
- After inserting the battery pack into the product, it may take a few moments for the product to power up.
 - Make sure that the battery pack is inserted correctly.
 - The battery pack will discharge by itself even if you do not use it. Charge the battery pack before use.
 - Make sure that the battery is NP-BX1.

[271] Troubleshooting | Troubleshooting | Battery pack and power

The power turns off suddenly.

-
- Depending on the product and battery pack temperature, the product may turn off automatically to protect itself. In this case, a message is displayed on the product screen before the product turns off.

[272] Troubleshooting | Troubleshooting | Battery pack and power

The remaining battery level indicator shows an incorrect level.

-
- This phenomenon occurs when you use the product in an extremely hot or cold location.
 - Battery capacity decreases over time and through repeated use. If decreased usage time between charges becomes significant, it is probably time to replace it with a new one.

[273] Troubleshooting | Troubleshooting | Battery pack and power

The charge lamp on the product/the CHARGE lamp of the battery charger flashes when charging the battery pack.

-
- Make sure that the battery is NP-BX1.
 - Batteries which have not been used for more than a year may have deteriorated.

- This phenomenon occurs when you charge the battery pack in an extremely hot or cold location. The optimum temperature for charging the battery pack is between 10 °C and 30 °C (50 °F and 86 °F).

[274] Troubleshooting | Troubleshooting | Battery pack and power

The battery pack is not charged.

- When the battery pack is not charged (the charge lamp does not light) even if you follow the proper charging procedure, check if the power of the product is turned off, then remove the battery pack and re-insert the same battery pack securely, or disconnect and reconnect the USB cable.

[275] Troubleshooting | Troubleshooting | Battery pack and power

The monitor does not turn on even when the product is turned on.

- [FINDER/MONITOR] has been set to [Viewfinder(Manual)] and the Electronic Viewfinder is popped up. Push down the Electronic Viewfinder or change [FINDER/MONITOR] to [Auto].

[276] Troubleshooting | Troubleshooting | Shooting still images/movies

You cannot record images.

- You are using a memory card with a write-protect switch, and the switch is set to the LOCK position. Set the switch to the record position.
- Check the free capacity of the memory card.
- You cannot record images while charging the flash.
- The [Self-timer] is activated.
- Set [Release w/o Card] to [Enable]. However, without a memory card inserted in the camera, images cannot be recorded.

Recording takes a long time.

- The noise reduction function is processing an image. This is not a malfunction.
- You are shooting in RAW mode. Since RAW data files are large, RAW mode shooting may take time.
- The [Auto HDR] function is processing an image.
- The product is compiling images.

The same image is captured multiple times.

- Set the drive mode to [Single Shooting].

The shutter is released continuously.

- The camera may automatically take multiple shots and perform overlay processing under the following conditions:
 - [ISO] is set to [Multi Frame NR].
 - The shooting mode is set to [Sweep Panorama].
 - The shooting mode is set to [Superior Auto].
 - The shooting mode is set to [Hand-held Twilight] or [Anti Motion Blur] under [Scene Selection].
 - [DRO/Auto HDR] is set to [Auto HDR].

The image is out of focus.

- The subject is too close.
- Press the shutter button halfway down, then shoot images.

- Ambient light is insufficient.
 - [Focus Mode] has been set to [Manual Focus]. Set [Focus Mode] to a setting other than [Manual Focus].
 - The position of the macro switching ring is incorrect. Set the macro switching index to “0,3 m-∞” (normal shooting) or “0,2 m-0,35 m” (macro shooting).
-

[281] Troubleshooting | Troubleshooting | Shooting still images/movies

Zoom does not work.

- You cannot use zoom functions during Sweep Panorama shooting.
 - You cannot use zoom functions in the following situations:
 - When using Smile Shutter function.
 - [ Quality] is set to [RAW] or [RAW & JPEG].
-

[282] Troubleshooting | Troubleshooting | Shooting still images/movies

The flash does not work.

- You cannot use a flash in the following situations:
 - When the following modes are selected in [Scene Selection].
 - [Anti Motion Blur]
 - [Night Scene]
 - [Hand-held Twilight]
 - During Sweep Panorama shooting.
 - During movie recording.
-

[283] Troubleshooting | Troubleshooting | Shooting still images/movies

Fuzzy white circular spots appear on images shot using the flash.

- Particles (dust, pollen, etc.) in the air reflected the flash light and appeared on the image. This is not a malfunction.

[284] Troubleshooting | Troubleshooting | Shooting still images/movies

The close-up shoot function (Macro) does not work.

- The product automatically adjusts the focus. Press and hold the shutter button halfway down. Focus adjustment may take some time when shooting a close subject.
 - The close-up shoot function will not work when the following modes are selected in [Scene Selection]:
 - [Sports Action]
 - The macro switching ring is not in the correct position.
-

[285] Troubleshooting | Troubleshooting | Shooting still images/movies

The recording date and time are not displayed on the screen.

- While shooting, the date and time are not displayed. They are displayed only during playback.
-

[286] Troubleshooting | Troubleshooting | Shooting still images/movies

The date and time are recorded incorrectly.

- Set the correct date and time.
 - The area selected using [Area Setting] differs from the actual area. Select the actual area.
-

[287] Troubleshooting | Troubleshooting | Shooting still images/movies

The aperture value and/or shutter speed flashes.

- The subject is too bright or too dark to shoot using the current aperture value and/or shutter speed settings. Readjust the settings.

[288] Troubleshooting | Troubleshooting | Shooting still images/movies

The image colors are not correct.

- Adjust [White Balance].
 - [Picture Effect] is set. Set [Picture Effect] to [Off].
 - To reset settings to default, perform [Setting Reset].
-

[289] Troubleshooting | Troubleshooting | Shooting still images/movies

Noise appears in the image when you view the screen in a dark place.

- The product is attempting to increase the visibility of the screen by temporarily brightening the monitor under conditions of low illumination. There is no effect on the recorded image.
-

[290] Troubleshooting | Troubleshooting | Shooting still images/movies

The eyes of the subject come out red.

- Set [Red Eye Reduction] to [On].
 - Shoot the subject at a distance closer than the flash range using the flash.
 - Light the room and shoot the subject.
-

[291] Troubleshooting | Troubleshooting | Shooting still images/movies

Dots appear and remain on the screen.

- This is not a malfunction. These dots are not recorded.
-

You cannot shoot images continuously.

- The memory card is full. Delete unnecessary images.
 - The battery level is low. Insert a charged battery pack.
-

The image is not clear in the viewfinder.

- Adjust the diopter scale properly using the diopter-adjustment dial.
-

No images appear on the viewfinder.

- [FINDER/MONITOR] has been set to [Monitor(Manual)]. Change [FINDER/MONITOR] to [Auto] or [Viewfinder(Manual)].
 - Bring your eye close to the viewfinder.
-

No images appear on the monitor.

- If you shoot images at waist height when [FINDER/MONITOR] has been set to [Auto] and the viewfinder is popped up, the monitor will turn off due to the reaction of the eye sensor. Set [FINDER/MONITOR] to [Monitor(Manual)] or push down the viewfinder.
-

[Finder/Monitor Sel.] does not work even though it has

been assigned to a certain key using [Custom Key(Shoot.)] or [Custom Key(PB)].

- [FINDER/MONITOR] is currently set to [Auto]. Set [FINDER/MONITOR] to [Viewfinder(Manual)] or [Monitor(Manual)].
-

[297] Troubleshooting | Troubleshooting | Shooting still images/movies

The image is whitish (Flare)./Blurring of light appears on the image (Ghosting).

- When pointing the lens toward the strong light source, excessive light enters the lens and the image may come out white (flare) or extraneous light (ghost images) may appear on the image, but this is not a malfunction.
Attach the lens hood (sold separately). Set up the composition so that you shoot images while avoiding backlit condition.
-

[298] Troubleshooting | Troubleshooting | Shooting still images/movies

The image is blurred.

- Camera shake is more likely to occur when shooting in a dark location because the shutter speed is slower. The use of a tripod or the flash is recommended.
-

[299] Troubleshooting | Troubleshooting | Shooting still images/movies

The monitor darkens after a short period of time passed.

- If you do not operate the product for a certain period of time, the product switches to the power-save mode. The product exits power-save mode when you perform operations such as pressing the shutter button halfway.

[300] Troubleshooting | Troubleshooting | Shooting still images/movies

The flash takes too long to recharge.

- The flash has been fired in succession in a short period. When the flash has been fired in succession, the recharging process may take longer than usual to avoid overheating of the camera.

[301] Troubleshooting | Troubleshooting | Shooting still images/movies

The control dial or control wheel does not work.

- [Dial / Wheel Lock] is on. Hold down the Fn button until the lock is released, or set the [Dial / Wheel Lock] to [Unlock].

[302] Troubleshooting | Troubleshooting | Shooting still images/movies

Sound is not recorded properly.

- Adjust the [Audio Rec Level].
- If you turn up the [Audio Rec Level] to the highest sound level, there will likely be sound clipping.

[303] Troubleshooting | Troubleshooting | Viewing images

Images cannot be played back.

- Make sure that the memory card is fully inserted into the product.
- The folder/file name has been changed on your computer.
- When an image file has been processed by a computer or when the image file was recorded using a model other than this product, playback on this product is not guaranteed.
- The product is in USB mode. Disconnect the product from the computer.
- Use PlayMemories Home to play back on this product images that are stored on your

computer.

[304] Troubleshooting | Troubleshooting | Viewing images

Displaying images takes a while.

- When an image shot in uncompressed RAW format is enlarged during playback, it takes some time for the image to be displayed.
-

[305] Troubleshooting | Troubleshooting | Viewing images

The date and time are not displayed.

- The screen display is set to display images only. Press DISP (Display Setting) on the control wheel to display the information.
-

[306] Troubleshooting | Troubleshooting | Viewing images

Images are not displayed on the monitor when using a thumb grip (sold separately).

- If you flip the grip toward the opposite side in order to press the  (Playback) button with the viewfinder popped up, the eye sensor may react to it. In this case, push down the viewfinder, or switch the display mode from viewfinder mode to monitor mode by pressing the button assigned [Finder/Monitor Sel.]. [Finder/Monitor Sel.] can be assigned to a button by using [Custom Key(Shoot.)]/[Custom Key(PB)].
-

[307] Troubleshooting | Troubleshooting | Viewing images

The image cannot be deleted.

- Cancel the protection.

[308] Troubleshooting | Troubleshooting | Viewing images

The image was deleted by mistake.

- Once you have deleted an image, you cannot restore it. We recommend that you protect images that you do not want to delete.

[309] Troubleshooting | Troubleshooting | Viewing images

A DPOF mark cannot be put.

- You cannot place DPOF marks on RAW images.

[310] Troubleshooting | Troubleshooting | Wi-Fi

You cannot find the wireless access point to be connected.

- Wireless access points may not be displayed on the product due to signal conditions. Place the product closer to the wireless access point.
- Wireless access points may not be displayed on the product depending on the access point settings. Refer to the instruction manual of the wireless access point.

[311] Troubleshooting | Troubleshooting | Wi-Fi

[WPS Push] does not work.

- [WPS Push] may not work depending on the access point settings. Check the SSID and password of the wireless access point, and perform [Access Point Set.].
-

[Send to Computer] is canceled halfway.

- When the battery remaining level is low, [Send to Computer] may be canceled halfway. Charge the battery pack and try again.
-

You cannot send movies to a smartphone.

- You cannot send XAVC S movies to a smartphone.
 - You cannot send AVCHD movies to a smartphone. Set [ File Format] to [MP4] before recording movies.
-



[Smart Remote Embedded] or [Send to Smartphone] is canceled halfway.

- When the remaining battery level is low, [Smart Remote Embedded] or [Send to Smartphone] may be canceled halfway. Charge the battery pack and try again.
-

The shooting screen for [Smart Remote Embedded] is not displayed smoothly./The connection between this product and the smartphone is disconnected.

- Data communication between this product and the smartphone may fail due to signal conditions. Place this product closer to the smartphone.
-

You cannot use One-Touch connection (NFC).

- Place the  (N mark) on the smartphone and the  (N mark) on the product as close together as possible. If there is no response, move the smartphone a few millimeters or move the smartphone away from this product, wait more than 10 seconds, and then touch them together again.
 - [Airplane Mode] is set to [On]. Set [Airplane Mode] to [Off].
 - Check whether the NFC function is activated on your smartphone. For details, refer to the instruction manual of the smartphone.
 - Do not place any metal objects other than a smartphone near the  (N mark).
 - Do not contact two or more smartphones to this product at the same time.
 - If another NFC-based application is running on your smartphone, terminate that application.
 - Switch to shooting mode before touching the smartphone to the product. The application will not activate if the product is in playback mode.
-

The computer does not recognize this product.

- Set [USB Connection] to [Mass Storage].
 - Check that the power of the camera is turned on.
 - If the battery level is low, insert a charged battery pack.
 - Use the micro USB cable (supplied) to connect the devices.
 - Disconnect the USB cable, and connect it again firmly.
 - Disconnect all equipment other than this product, the keyboard and the mouse from the USB terminals of your computer.
 - Connect this product directly to your computer without passing through a USB hub or other device.
 - If you set [USB Power Supply] to [Off], the computer may be able to recognize this product.
-

You cannot import images.

- Connect this product and your computer correctly making a USB connection.
 - When you shoot images with a memory card formatted by a computer, you may not be able to import the images to a computer. Shoot using a memory card formatted by this product.
-

[319] Troubleshooting | Troubleshooting | Computers

The image and sound are interrupted by noise when viewing a movie on a computer.

- You are playing back the movie directly from the memory card. Import the movie to your computer using PlayMemories Home and play it back.
-

[320] Troubleshooting | Troubleshooting | Computers

Images exported from a computer cannot be viewed on this product.

- Use PlayMemories Home to copy images that are stored on a computer onto a memory card inserted into this product and view them on this product.
-

[321] Troubleshooting | Troubleshooting | Memory cards

Formatted the memory card by mistake.

- All the data on the memory card is deleted by formatting. You cannot restore the data.
-

[322] Troubleshooting | Troubleshooting | Printing

You cannot print images.

- RAW images cannot be printed. To print RAW images, first convert them to JPEG images using Image Data Converter.

[323] Troubleshooting | Troubleshooting | Printing

The color of the image is strange.

- When you print the images recorded in Adobe RGB mode using sRGB printers that are not compatible with Adobe RGB (DCF2.0/Exif2.21), the images are printed at a lower saturation.

[324] Troubleshooting | Troubleshooting | Printing

Images are printed with both edges cut off.

- Depending on your printer, the left, right, top, and bottom edges of the image may be cut off. Especially when you print an image shot with [ Aspect Ratio] set to [16:9], the lateral end of the image may be cut off.
- When printing images using your printer, cancel the trimming or borderless settings of the printer. Consult the printer manufacturer as to whether the printer provides these functions or not.
- When you print images at a shop, ask the shop whether they can print the images without cutting off both edges.

[325] Troubleshooting | Troubleshooting | Printing

You cannot print images with the date.

- If you set [ Write Date] to [On], you can print still images with the date. Note that you cannot delete the date from the image on the camera.
- If you want to print images with the date, use [Print Setting] under [Specify Printing].
- You can print images with the date superimposed if the printer or the software can recognize Exif information. For compatibility with Exif information, consult the manufacturer of the printer or the software.
- Using PlayMemories Home (Windows version only), you can insert a date even into

images that were taken without recording the date.

- When you print images at a shop, images can be printed with the date if you ask them to do so.

[326] [Troubleshooting](#) | [Troubleshooting](#) | [Others](#)

The lens gets fogged.

-
- Moisture condensation has occurred. Turn off the product and leave it for about an hour before using it.

[327] [Troubleshooting](#) | [Troubleshooting](#) | [Others](#)

The product becomes warm when you use it for a long time.

-
- This is not a malfunction. Turn off the product and do not use it for a while.

[328] [Troubleshooting](#) | [Troubleshooting](#) | [Others](#)

The Clock Set screen appears when you turn on the product.

-
- Set the date and time again.
 - The internal rechargeable backup battery has discharged. Insert a charged battery, and set aside for 24 hours or more with the power left off.

[329] [Troubleshooting](#) | [Troubleshooting](#) | [Others](#)

The number of recordable images does not decrease, or decreases two images at a time.

- This is because the compression rate and the image size after compression change depending on the image when you shoot a JPEG image.

[330] Troubleshooting | Troubleshooting | Others

Settings are reset even though resetting operation has not been performed.

- The camera settings may be reset if the battery pack is ejected while the power is on. When ejecting the battery pack, first turn the power off and check that the access lamp is not illuminated before ejecting.

[331] Troubleshooting | Troubleshooting | Others

The product does not work properly.

- Turn off the product. Remove the battery pack and insert it again. If the product is hot, remove the battery pack, and allow it to cool down before trying this corrective procedure.

[332] Troubleshooting | Troubleshooting | Others

“--E-” appears on the screen.

- Remove the memory card, and insert it again. If the problem persists even after performing this procedure, format the memory card.

[333] Troubleshooting | Messages | Messages

Self-diagnosis display

If a code starting with a letter of the alphabet appears, the self-diagnosis function on this product is working. The last two digits (indicated by □□) will differ depending on the state of

this product.

If you cannot solve the problem even after trying the following corrective actions a few times, this product may need repair. Contact your Sony dealer or local authorized Sony service facility.

C:32:□□

- There is trouble with the product's hardware. Turn the power off and on again.

C:13:□□

- This product cannot read or write data on the memory card. Try turning off and on this product again, or taking out and inserting the memory card several times.
- An unformatted memory card is inserted. Format the memory card.
- The inserted memory card cannot be used with this product, or the data is damaged. Insert a new memory card.

E:61:□□

E:62:□□

E:91:□□

- A product malfunction has occurred. Initialize this product, then turn the power on again.

E:94:□□

- There is a malfunction when writing or deleting data. Repair is required. Contact your Sony dealer or local authorized Sony service facility. Be prepared to give all numbers in the error code beginning from the E.

[334] Troubleshooting | Messages | Messages

Warning messages

Set Area/Date/Time.

- Set the area, date and time. If you have not used the product for a long time, charge the internal rechargeable backup battery.

Unable to use memory card. Format?

- The memory card was formatted on a computer and the file format was modified. Select [Enter], and then format the memory card. You can use the memory card again, however, all previous data in the memory card is erased. It may take some time to complete the

format. If the message still appears, change the memory card.

Memory Card Error

- An incompatible memory card is inserted.
- Formatting has failed. Format the memory card again.

Unable to read memory card. Reinsert memory card.

- An incompatible memory card is inserted.
- The memory card is damaged.
- The terminal section of the memory card is dirty.

Memory card locked.

- You are using a memory card with a write-protect switch or a delete-protect switch with the switch set to the LOCK position. Set the switch to the record position.

Cannot open the shutter since the memory card is not inserted.

- No memory card has been inserted.
- To release the shutter without inserting a memory card into the camera, set [Release w/o Card] to [Enable]. In this case, images will not be saved.

This memory card may not be capable of recording and playing normally.

- An incompatible memory card is inserted.

Processing...

- When performing noise reduction, the reduction process takes place. You cannot do any further shooting during this reduction process.

Unable to display.

- Images recorded with other products or images modified with a computer may not be displayed.
- Processing on the computer such as deletion of the image files may cause inconsistencies in the image database files. Repair the image database files.

Unable to print.

- You tried to mark RAW images with a DPOF mark.

Internal temp. high. Allow it to cool.

- The product has become hot because you have been shooting continuously. Turn the power off. Cool the product and wait until the product is ready to shoot again.



- You have been recording images for a long time, the product temperature has risen. Stop recording images until the product cools.

Recording is unavailable in this movie format.

- Set [ File Format] to [MP4].



- The number of images exceeds that for which date management in a database file by the product is possible.



- Unable to register to the database file. Import all the images to a computer and recover the memory card.

Image DataBase File error

- There is something wrong in the Image Database File. Select [Setup] → [Recover Image DB].

System Error

Camera Error. Turn power off then on.

- Remove the battery pack, and then re-insert it. If the message appears frequently, consult your Sony dealer or local authorized Sony service facility.

Unable to magnify.

Unable to rotate image.

- Images recorded with other products may not be enlarged or rotated.

Cannot create more folders.

- A folder in the memory card has the first three digits "999." You cannot create any more folders on this camera.

MACRO (flashing)

- When the macro switching index is midway between "0,3 m-∞" (normal shooting) and "0,2 m-0,35 m" (macro shooting), the MACRO indicator flashes. Set the macro switching index to either "0,3 m-∞" or "0,2 m-0,35 m."

[335] Troubleshooting | Situations this product has difficulty handling | Situations this product has difficulty handling

Situations this product has difficulty handling

The product cannot take full advantage of some features under certain circumstances. When shooting under the following conditions, either recompose the shot or change the

shooting mode, then shoot the images again.

Low light conditions

- Sweep Panorama
- Lock-on AF

Overly bright conditions

- Lock-on AF

Varying levels of brightness

- Lock-on AF

Flickering lights

- Sweep Panorama

Subjects too close to the product

- Sweep Panorama

Subjects with large movements or subjects that move too quickly

- Superior Auto
- Sweep Panorama
- Auto HDR
- Lock-on AF

Subjects too small or too large

- Sweep Panorama
- Lock-on AF

Scenes with little contrast, such as the sky or a sandy beach

- Sweep Panorama
- Superior Auto

Scenes changing constantly, such as a waterfall

- Sweep Panorama
- Superior Auto