



Use this manual if you encounter any problems, or have any questions about your product.  
This Help Guide is also available as a PDF, which can be downloaded [here](#).



### How to tag the location information on the images

You can record the location information on the images. The location information can be acquired via a smartphone.



### Touch Focus

You can select the subject to focus by the touch operation in the still image and movie recording modes.



### DSC-RX10M4 Accessories compatibility information

This website provides the accessories compatibility information. (Another window will open.)

[Names of parts/Icons and indicators](#)

[Identifying parts](#)

## Basic operations

- [Using the control wheel](#) >
- [Using the lens ring](#) >
- [Using MENU items](#) >
- [Using the Fn \(Function\) button](#) >
- [How to use the Quick Navi screen](#) >
- [How to use the keyboard](#) >

## Icons and indicators

- [List of icons on the screen](#) >
- [Indicators on the display panel](#) >
- [Switching the screen display \(while shooting/during playback\)](#) >
- [DISP Button \(Monitor/Finder\)](#) >

## Preparing the camera

### Checking the camera and the supplied items

### Charging the battery pack

- [Inserting/removing the battery pack](#) >
- [Charging the battery pack while it is inserted in the camera](#) >
- [Charging by connecting to a computer](#) >
- [Battery life and number of recordable images](#) >
- [Supplying power from a wall outlet \(wall socket\)](#) >
- [Notes on the battery pack](#) >
- [Notes on charging the battery pack](#) >

### Inserting a memory card (sold separately)

- [Inserting/removing a memory card](#) >
- [Memory cards that can be used](#) >
- [Notes on memory card](#) >

### Attaching the lens hood

### Setting language, date and time

### In-Camera Guide

## Shooting

## Shooting still images

### Focusing

└ Focus Mode >

### Auto focus

└ Focus Area >

└ Phase detection AF >

└ Focus Standard >

└ Adjusting the focus area settings to the camera's orientation (horizontal/vertical) (Sw. V/H AF Area) >

└ AF/MF control >

└ AF w/ shutter (still image) >

└ AF On >

└ Eye AF >

└ Center Lock-on AF >

└ Focus Hold >

└ Registering the current focus area (AF Area Regist.) >

└ Deleting a registered AF Area (Del. Reg. AF Area) >

└ Pre-AF (still image) >

└ AF Illuminator (still image) >

└ AF Area Auto Clear >

└ Disp. cont. AF area >

└ Phase Detect. Area >

### Manual focus

└ Manual Focus >

└ Direct manual focus (DMF) >

└ Focus Magnifier >

└ MF Assist (still image) >

└ Focus Magnif. Time >

└ Initial Focus Mag. (still image) >

└ Peaking Level >

└ Peaking Color >

Focus Ring Rotate >

### Selecting a drive mode (Continuous shooting/Self-timer)

Drive Mode >

Cont. Shooting >

Self-timer >

Self-timer(Cont) >

Cont. Bracket >

Single Bracket >

Indicator during bracket shooting >

WB bracket >

DRO Bracket >

Bracket Settings >

### Using touch functions

Touch Operation >

Touch Focus >

Touch Pad Settings >

### Selecting still image size/image quality

Image Size (still image) >

Aspect Ratio (still image) >

Quality (still image) >

Panorama: Size >

Panorama: Direction >

### Selecting a shooting mode

List of mode dial function >

Intelligent Auto >

Superior Auto >

Switching the auto mode (Auto Mode) >

About Scene Recognition >

Program Auto >

Aperture Priority >

- Shutter Priority >

---

- Manual Exposure >

---

- Bulb shooting >

---

- Sweep Panorama >

---

- Scene Selection >

---

- Recall (Camera Settings1/Camera Settings2) >

---

- Movie: Exposure Mode >

---

- HFR (High Frame Rate): Exposure Mode >

### Controlling the exposure/metering modes

- Exposure Comp. >

---

- Reset EV Comp. >

---

- Exposure Set. Guide >

---

- Metering Mode >

---

- Spot Metering Point >

---

- AE lock >

---

- AEL w/ shutter (still image) >

---

- Exposure Std. Adjust >

---

- Exp.comp.set >

---

- Zebra >

### Correcting brightness and contrast automatically

- D-Range Opt. (DRO) >

---

- Auto HDR >

### Selecting the ISO sensitivity

- ISO >

---

- ISO AUTO Min. SS >

### Using the zoom

- The zoom features available with this product >

---

- Zoom >

---

- Zoom Setting >

---

- About zoom scale >

- Zoom Assist >
- Rng. of Zoom Assist >
- Zoom Speed >
- Zoom Ring Rotate >
- Smart Telecon. >
- Zoom Func. on Ring >

## White balance

- White Balance >
- Priority Set in AWB >
- Capturing a basic white color in [Custom Setup] mode >

## Setting how to process images

- Creative Style >
- Picture Effect >
- Soft Skin Effect (still image) >
- Auto Obj. Framing (still image) >
- Color Space (still image) >

## Shutter settings

- Release w/o Card >
- Shutter Type (still image) >

## Reducing blur

- SteadyShot (still image) >

## Noise reduction

- Long Exposure NR (still image) >
- High ISO NR (still image) >

## Face detection

- Smile/Face Detect. >
- Face Registration (New Registration) >
- Face Registration (Order Exchanging) >
- Face Registration (Delete) >

## Using the flash

Using flash	>
Red Eye Reduction	>
Flash Mode	>
Flash Comp.	>
Wireless flash shooting	>

## Recording movies

### Shooting movies

Movie w/ shutter

Movie recording formats

File Format (movie)

Record Setting (movie)

Shooting super-slow-motion movies (HFR Settings)

Capturing still images while recording movies (Dual Rec)

Quality(Dual Rec)

Img. Size(Dual Rec)

Auto Dual Rec

Proxy Recording

Audio Recording

Audio Level Display

Audio Rec Level

Audio Out Timing

Wind Noise Reduct.

Picture Profile

Gamma Disp. Assist

Auto Slow Shut. (movie)

AF drive speed (movie)

AF Track Sens (movie)

SteadyShot (movie)

TC/UB Settings

TC/UB Disp. Switch

MOVIE Button

Marker Display (movie)

Marker Settings (movie)

4K Output Sel. (movie)

Video Light Mode

## Viewing

### Viewing images

- Playing back still images >
- Enlarging an image being played back (Enlarge Image) >
- Rotating recorded images automatically (Display Rotation) >
- Rotating an image (Rotate) >
- Playing back panoramic images >
- Enlarge Init. Mag. >
- Enlarge Initial Pos. >
- Playing back movies >
- Motion Shot Video >
- Motion Interval ADJ >
- Volume Settings >
- Photo Capture >
- Playing back images on the image index screen (Image Index) >
- Switching between still images and movies (View Mode) >
- Disp Cont Shoot Grp >
- Playing back images using slideshow (Slide Show) >

### Protecting data

- Protecting images (Protect) >

### Designating images for printing (DPOF)

- Specifying images to be printed (Specify Printing) >

### Deleting images

- Deleting a displayed image >
- Deleting multiple selected images (Delete) >



└ Delete confirm. >

## Viewing images on a TV

└ Viewing images on a TV using an HDMI cable >

## Customizing the camera

### Registering frequently used functions

└ Memory (Camera Settings1/Camera Settings2) >

└ Registering shooting settings to a custom key (Reg Cust Shoot Set) >

### Assigning selected functions to the button

└ Custom Key(Shoot.)/Custom Key(PB) >

└ Function Menu Set. >

### Customizing the functions of the ring/dial

└ Lens Ring Setup >

└ Dial / Wheel Lock >

### Customizing MENU (My Menu)

└ Add Item >

└ Sort Item >

└ Delete Item >

└ Delete Page >

└ Delete All >

### Checking images before/after recording

└ Auto Review >

└ Live View Display >

### Monitor/viewfinder settings

└ Grid Line >

└ FINDER/MONITOR >

└ Deactivate Monitor >

└ Monitor Brightness >

└ Viewfinder Bright. >

└ Finder Color Temp. >

└ Display Quality >

Bright Monitoring >

## Memory card settings

Format >

File Number >

Set File Name >

Display Media Info. >

Select REC Folder >

New Folder >

Folder Name >

Recover Image DB >

## Camera settings

Audio signals >

Write Date (still image) >

Tile Menu >

Mode Dial Guide >

Pwr Save Start Time >

NTSC/PAL Selector >

HDMI Settings: HDMI Resolution >

HDMI Settings: 24p/60p Output (movie) (Only for 1080 60i compatible models) >

HDMI Settings: HDMI Info. Display >

HDMI Settings: TC Output (movie) >

HDMI Settings: REC Control (movie) >

HDMI Settings: CTRL FOR HDMI >

USB Connection >

USB LUN Setting >

USB Power Supply >

PC Remote Settings: Still Img. Save Dest. >

PC Remote Settings: RAW+J PC Save Img >

Language >

Date/Time Setup >

- Area Setting >
- Copyright Info >
- Version >
- Demo Mode >

### Initializing the camera

- Setting Reset >

## Using network functions

### Connecting this product and a Smartphone

- PlayMemories Mobile >
- Controlling the camera using an Android smartphone (NFC One-touch remote) >
- Controlling the camera using an Android smartphone (QR code) >
- Controlling the camera using an Android smartphone (SSID) >
- Controlling the camera using an iPhone or iPad (QR code) >
- Controlling the camera using an iPhone or iPad (SSID) >

### Transferring images to a Smartphone

- Snd to Smrtphn Func: Send to Smartphone >
- Snd to Smrtphn Func: Sending Target (proxy movies) >
- Sending images to an Android smartphone (NFC One-touch Sharing) >

### Transferring images to a computer

- Send to Computer >

### Transferring images to a TV

- View on TV >

### Reading location information from a smartphone

- Loc. Info. Link Set. >

### Changing the network settings

- Airplane Mode >
- Wi-Fi Settings: WPS Push >
- Wi-Fi Settings: Access Point Set. >
- Wi-Fi Settings: Disp MAC Address >
- Wi-Fi Settings: SSID/PW Reset >

- [Edit Device Name](#) >
- [Reset Network Set.](#) >

## Using a computer

### Recommended computer environment

### Software for Mac computers

### Importing images for use on a computer

- [PlayMemories Home](#) >
- [Installing PlayMemories Home](#) >
- [Connecting to a computer](#) >
- [Importing images to the computer without using PlayMemories Home](#) >
- [Disconnecting the camera from the computer](#) >

### Developing RAW images (Image Data Converter)

- [Image Data Converter](#) >
- [Installing Image Data Converter](#) >

### Controlling the camera from a computer (Remote Camera Control)

- [Remote Camera Control](#) >
- [Installing Remote Camera Control](#) >

### Creating a movie disc

- [Selecting a disc to be created](#) >
- [Creating Blu-ray Discs from high-definition image quality movies](#) >
- [Creating DVD discs \(AVCHD recording discs\) from high-definition image quality movies](#) >
- [Creating DVD discs from standard image quality movies](#) >

## List of MENU items

### Using MENU items

#### Camera Settings<sup>1</sup>

- [Quality \(still image\)](#) >
- [Image Size \(still image\)](#) >
- [Aspect Ratio \(still image\)](#) >
- [Panorama: Size](#) >
- [Panorama: Direction](#) >

- Long Exposure NR (still image)	>
- High ISO NR (still image)	>
- Color Space (still image)	>
- Switching the auto mode (Auto Mode)	>
- Scene Selection	>
- Drive Mode	>
- Bracket Settings	>
- Recall (Camera Settings1/Camera Settings2)	>
- Memory (Camera Settings1/Camera Settings2)	>
- Registering shooting settings to a custom key (Reg Cust Shoot Set)	>
- Focus Area	>
- Adjusting the focus area settings to the camera's orientation (horizontal/vertical) (Sw. V/H AF Area)	>
- AF Illuminator (still image)	>
- Center Lock-on AF	>
- AF w/ shutter (still image)	>
- Pre-AF (still image)	>
- Registering the current focus area (AF Area Regist.)	>
- Deleting a registered AF Area (Del. Reg. AF Area)	>
- AF Area Auto Clear	>
- Disp. cont. AF area	>
- Phase Detect. Area	>
- Exposure Comp.	>
- Reset EV Comp.	>
- ISO	>
- ISO AUTO Min. SS	>
- Metering Mode	>
- Spot Metering Point	>
- AEL w/ shutter (still image)	>
- Exposure Std. Adjust	>
- Flash Mode	>

- Flash Comp. >
- Exp.comp.set >
- Red Eye Reduction >
- White Balance >
- Priority Set in AWB >
- D-Range Opt. (DRO) >
- Auto HDR >
- Creative Style >
- Picture Effect >
- Picture Profile >
- Soft Skin Effect (still image) >
- Focus Magnifier >
- Focus Magnif. Time >
- Initial Focus Mag. (still image) >
- MF Assist (still image) >
- Peaking Level >
- Peaking Color >
- Focus Ring Rotate >
- Smile/Face Detect. >
- Face Registration (New Registration) >
- Face Registration (Order Exchanging) >
- Face Registration (Delete) >
- Auto Obj. Framing (still image) >

## Camera Settings2

- Movie: Exposure Mode >
- HFR (High Frame Rate): Exposure Mode >
- File Format (movie) >
- Record Setting (movie) >
- Shooting super-slow-motion movies (HFR Settings) >
- Capturing still images while recording movies (Dual Rec) >

- Quality(Dual Rec)	>
- Img. Size(Dual Rec)	>
- Auto Dual Rec	>
- Proxy Recording	>
- AF drive speed (movie)	>
- AF Track Sens (movie)	>
- Auto Slow Shut. (movie)	>
- Audio Recording	>
- Audio Rec Level	>
- Audio Level Display	>
- Audio Out Timing	>
- Wind Noise Reduct.	>
- SteadyShot (movie)	>
- Marker Display (movie)	>
- Marker Settings (movie)	>
- Video Light Mode	>
- Movie w/ shutter	>
- Shutter Type (still image)	>
- Release w/o Card	>
- SteadyShot (still image)	>
- Rng. of Zoom Assist	>
- Zoom Setting	>
- Zoom Speed	>
- Zoom Ring Rotate	>
- Zoom Func. on Ring	>
- DISP Button (Monitor/Finder)	>
- FINDER/MONITOR	>
- Zebra	>
- Grid Line	>
- Exposure Set. Guide	>

- Live View Display >

---

- Auto Review >

---

- Custom Key(Shoot.)/Custom Key(PB) >

---

- Function Menu Set. >

---

- Lens Ring Setup >

---

- MOVIE Button >

---

- Dial / Wheel Lock >

---

- Audio signals >

---

- Write Date (still image) >

## Network

- Snd to Smrtphn Func: Send to Smartphone >

---

- Snd to Smrtphn Func: Sending Target (proxy movies) >

---

- Send to Computer >

---

- View on TV >

---

- Ctrl w/ Smartphone >

---

- Airplane Mode >

---

- Wi-Fi Settings: WPS Push >

---

- Wi-Fi Settings: Access Point Set. >

---

- Wi-Fi Settings: Disp MAC Address >

---

- Wi-Fi Settings: SSID/PW Reset >

---

- Bluetooth Settings >

---

- Loc. Info. Link Set. >

---

- Edit Device Name >

---

- Reset Network Set. >

## Playback

- Deleting multiple selected images (Delete) >

---

- Switching between still images and movies (View Mode) >

---

- Playing back images on the image index screen (Image Index) >

---

- Disp Cont Shoot Grp >

---

- Rotating recorded images automatically (Display Rotation) >



- Playing back images using slideshow (Slide Show) >

---

- Rotating an image (Rotate) >

---

- Enlarging an image being played back (Enlarge Image) >

---

- Enlarge Init. Mag. >

---

- Enlarge Initial Pos. >

---

- Protecting images (Protect) >

---

- Motion Interval ADJ >

---

- Specifying images to be printed (Specify Printing) >

---

- Photo Capture >

## Setup

- Monitor Brightness >

---

- Viewfinder Bright. >

---

- Finder Color Temp. >

---

- Gamma Disp. Assist >

---

- Volume Settings >

---

- Tile Menu >

---

- Mode Dial Guide >

---

- Delete confirm. >

---

- Display Quality >

---

- Pwr Save Start Time >

---

- NTSC/PAL Selector >

---

- Touch Operation >

---

- Touch Pad Settings >

---

- Demo Mode >

---

- TC/UB Settings >

---

- HDMI Settings: HDMI Resolution >

---

- HDMI Settings: 24p/60p Output (movie) (Only for 1080 60i compatible models) >

---

- HDMI Settings: HDMI Info. Display >

---

- HDMI Settings: TC Output (movie) >

---

- HDMI Settings: REC Control (movie) >

- HDMI Settings: CTRL FOR HDMI >

---

- 4K Output Sel. (movie) >

---

- USB Connection >

---

- USB LUN Setting >

---

- USB Power Supply >

---

- PC Remote Settings: Still Img. Save Dest. >

---

- PC Remote Settings: RAW+J PC Save Img >

---

- Language >

---

- Date/Time Setup >

---

- Area Setting >

---

- Copyright Info >

---

- Format >

---

- File Number >

---

- Set File Name >

---

- Select REC Folder >

---

- New Folder >

---

- Folder Name >

---

- Recover Image DB >

---

- Display Media Info. >

---

- Version >

---

- Setting Reset >

### My Menu

- Add Item >

---

- Sort Item >

---

- Delete Item >

---

- Delete Page >

---

- Delete All >

### Precautions/This product

Precautions

On cleaning

[Number of recordable images](#)

---

[Recordable movie times](#)

---

[Using the AC Adaptor/battery charger abroad](#)

---

[AVCHD format](#)

---

[License](#)

---

[Trademarks](#)

---

[If you have problems](#)

---

[Troubleshooting](#)

---

[Self-diagnosis display](#)

---

[Warning messages](#)

---

## Identifying parts

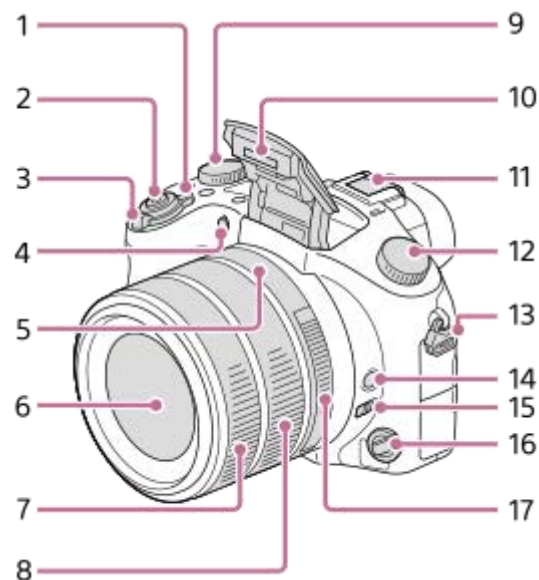

1. ON/OFF (Power) switch
2. Shutter button
3. For shooting: W/T (zoom) lever  
For viewing:  (Index) lever/Playback zoom lever
4. Self-timer lamp/AF illuminator
5. Aperture index
6. Lens
7. Front lens ring
8. Rear lens ring
9. Exposure compensation dial
10. Flash

- Press the  (Flash pop-up) button to use the flash. The flash does not pop up automatically.
- When not using the flash, press it back into the camera body.



### 11. Multi Interface Shoe

- Some accessories may not go in all the way and protrude backward from the Multi interface shoe. However, when the accessory reaches the front end of the shoe, the connection is completed.
- For details on compatible accessories for the multi interface shoe, visit the Sony website, or consult your Sony dealer or local authorized Sony service facility. Accessories for the Accessory Shoe can also be used. Operations with other manufactures' accessories are not guaranteed.

 Multi  
Interface Shoe

 Accessory Shoe

### 12. Mode dial

**AUTO** (Auto Mode/P(Program Auto)/A(Aperture Priority)/S(Shutter Priority)/M(Manual Exposure)/MR(Memory recall)/ (Movie)/ HFR(High Frame Rate)/ (Sweep Panorama)/SCN(Scene Selection)

### 13. Hook for shoulder strap

- Attach both ends of the strap onto the camera.

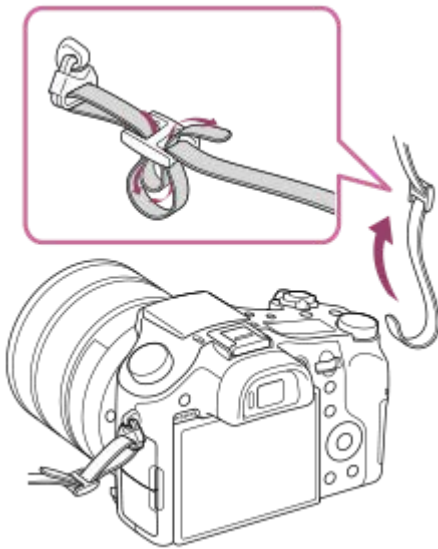

14. Focus hold button
15. Focus range limiter switch
16. Focus mode dial
17. Aperture ring

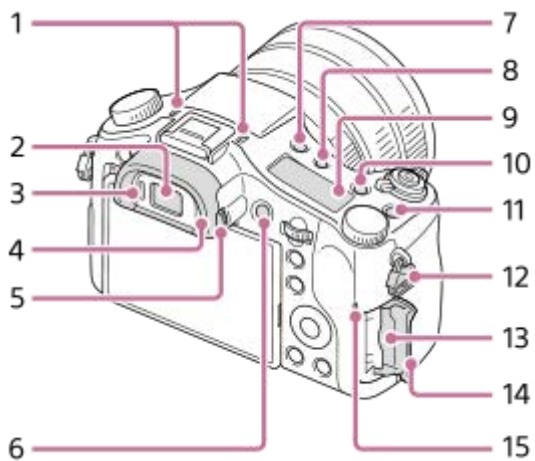

1. Microphone

- Do not cover this part during movie recording. Doing so may cause noise or lower the volume.

2. Viewfinder
3. Eye sensor
4. Eyepiece Cup

**Removing the eyepiece cup**

Grasp the eyepiece cup on the left and right sides to remove it.



5. Diopter-adjustment dial

- Adjust the diopter-adjustment dial to your eyesight until the display appears clearly in the viewfinder. If it is difficult to turn the diopter-adjustment dial, remove the eyepiece cup and then adjust the dial.

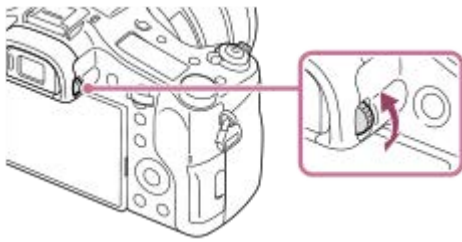

6. MOVIE (Movie) button
7. ⚡ (Flash pop-up) button
8. ☀️ (Display panel illumination) button
9. Display panel
10. C2 button (Custom button 2)
11. C1 button (Custom button 1)
12. Hook for shoulder strap
13. Memory card slot
14. Memory card cover
15. Access lamp

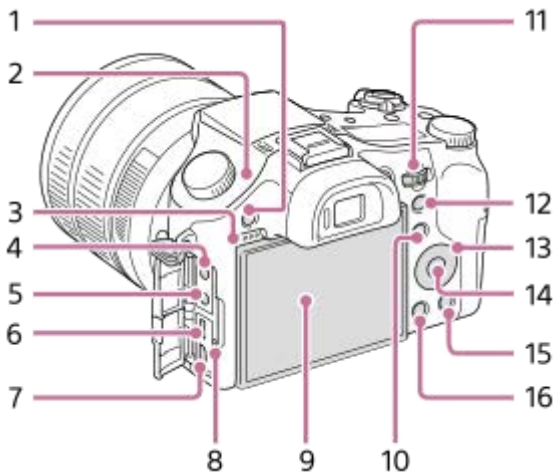

1. MENU button
2. ⊖ Image sensor position mark

- The image sensor is the sensor that converts light into an electric signal. The ⊖ mark shows the location of the image sensor. When you measure the exact distance between the camera and the subject, refer to the position of the horizontal line.

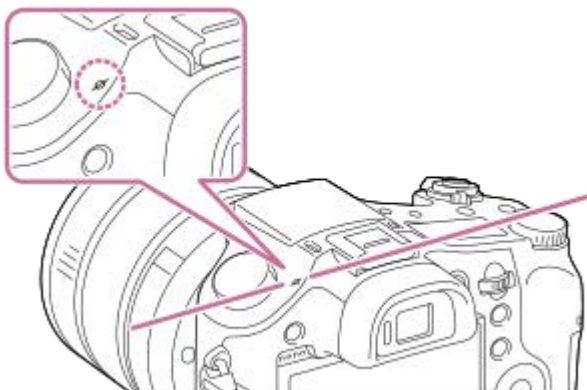

- If the subject is closer than the minimum shooting distance of the lens, the focus cannot be confirmed. Make sure you put enough distance between the subject and the camera.

3. Speaker
4. 🎧 (Microphone) jack

- When an external microphone is connected, the built-in microphone turns off automatically. When the external microphone is a plugin-power type, the power of the microphone is supplied by the camera.

5.  (Headphones) jack

6. Multi/Micro USB Terminal

- This terminal supports Micro USB-compatible devices.
- For details on compatible accessories for the Multi/Micro USB Terminal, visit the Sony website, or consult your Sony dealer or local authorized Sony service facility.

7. HDMI micro jack

8. Charge lamp

9. Monitor (For touch operation: Touch panel/Touch pad)

- You can adjust the monitor to an easily viewable angle and shoot from any position.

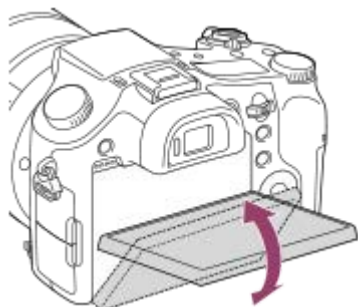

- You may not be able to adjust the monitor angle depending on the type of a tripod you use. In such a case, release the tripod screw once to adjust the monitor angle.

10. For shooting: Fn (Function) button

For viewing:  (Send to Smartphone) button

- You can display the screen for [Send to Smartphone] by pressing this button.

11. Control dial

- You can quickly adjust the settings for each shooting mode.

12. For shooting: AEL button

For viewing:  (Playback zoom) button

13. Control wheel

14. Center button

15. For shooting: **C3** button (Custom button 3)

For viewing:  (Delete) button

16.  (Playback) button

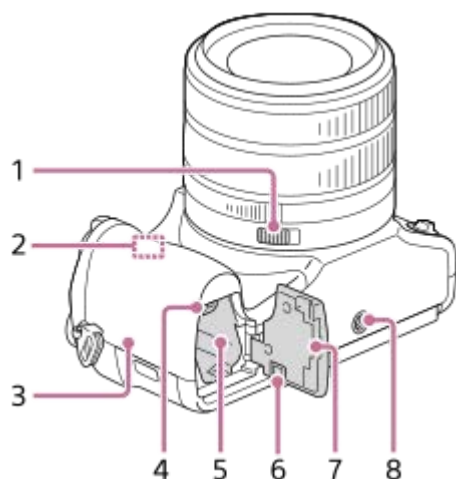

1. Aperture Click Switch

2. Wi-Fi/Bluetooth antenna (built-in)

3. **N** (N mark)

- This mark indicates the touch point for connecting the camera and an NFC-enabled Smartphone.

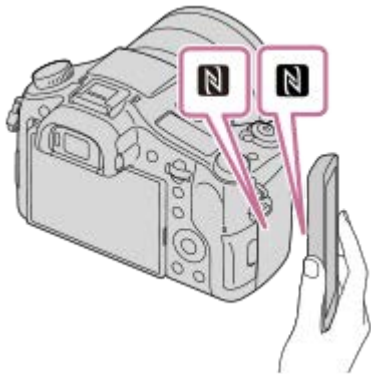

- NFC (Near Field Communication) is an international standard of the short-range wireless communication technology.

4. Battery lock lever

5. Battery insertion slot

6. Connection plate cover

- Use this when using an AC-PW20 AC Adaptor (sold separately). Insert the connection plate into the battery compartment, and then pass the cord through the connection plate cover as shown below.

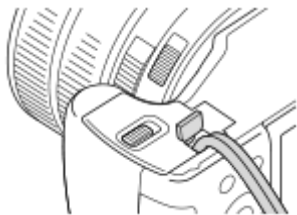

- Make sure that the cord is not pinched when you close the cover.

7. Battery cover

8. Tripod socket hole

- Use a tripod with a screw less than 5.5 mm (7/32 inches) long. Otherwise, you cannot firmly secure the camera, and damage to the camera may occur.



## Using the control wheel

---

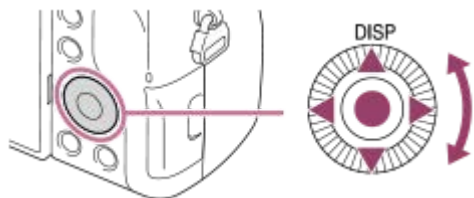

- You can select setting items by turning or pressing the top/bottom/left/right side of the control wheel. Your selection is determined when you press the center of the control wheel.
  - The DISP (Display Setting) is assigned to the top side of the control wheel. In addition, you can assign selected functions to the left/right/bottom side and the center of the control wheel, and to the rotation of the control wheel.
  - During playback, you can display the next/previous image by pressing the right/left side of the control wheel or by turning the control wheel.
- 

### Related Topic

- [Focus Standard](#)
- [Custom Key\(Shoot.\)/Custom Key\(PB\)](#)

Digital Still Camera  
DSC-RX10M4

## Using the lens ring

---

By turning the front lens ring **(A)** and rear lens ring **(B)**, you can use the zoom and focus functions more intuitively. You can also switch the assignment of the zoom and focus functions to the front lens ring or the rear lens ring using [Lens Ring Setup].

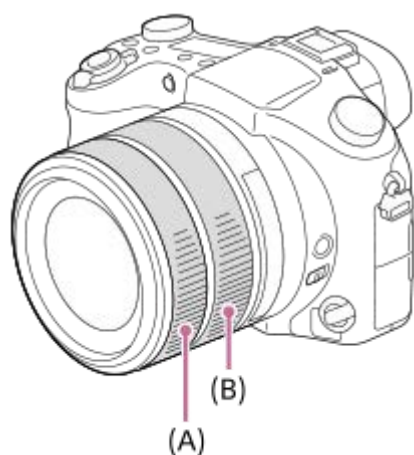

Icons and function names are displayed on the screen as follows.

Ex.

 **ZOOM** : Adjust the zoom by turning the rear lens ring **(B)**.

 **FOCUS** : Adjust the focus by turning the front lens ring **(A)**, and adjust the zoom by turning the rear lens ring **(B)**.

---

### Related Topic

- [Lens Ring Setup](#)

## Using MENU items

You can change settings related to all the camera operations including shooting, playback, and operating method. You can also execute camera functions from the MENU.

- 1 Press the MENU button to display the menu screen.

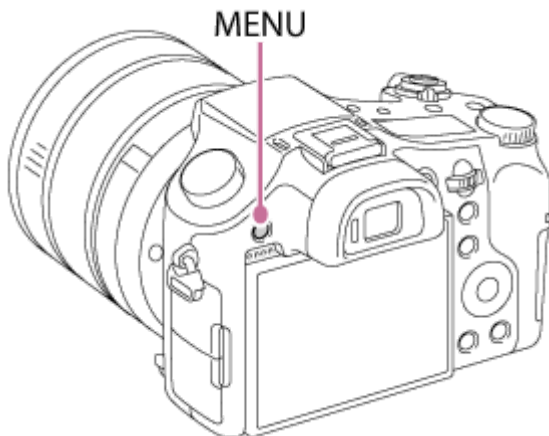

- 2 Select the desired setting you want to adjust using the top/bottom/left/right sides of the control wheel or by turning the control wheel, and then press the center of the control wheel.
  - Select an icon at the top of the screen (A) and press the left/right side of the control wheel to move to another MENU item.
  - You can go back to the previous screen by pressing the MENU button (B).

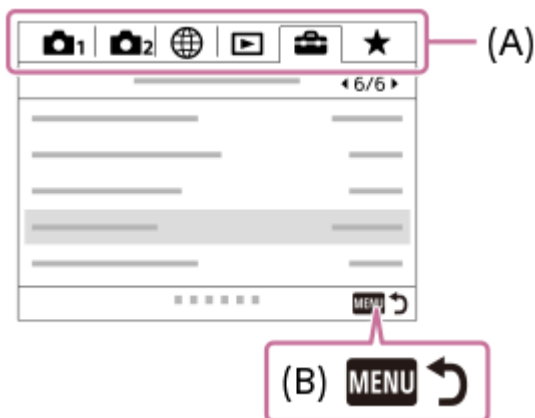

- 3 Select the desired setting value, and press the center to confirm your selection.

### Related Topic

- [Tile Menu](#)



## Using the Fn (Function) button

You can register frequently used functions to the Fn (Function) button and recall them while shooting. Up to 12 frequently used functions can be registered to the Fn (Function) button.

- 1 Press the DISP on the control wheel repeatedly to display a screen mode other than [For viewfinder], and then press the Fn (Function) button.

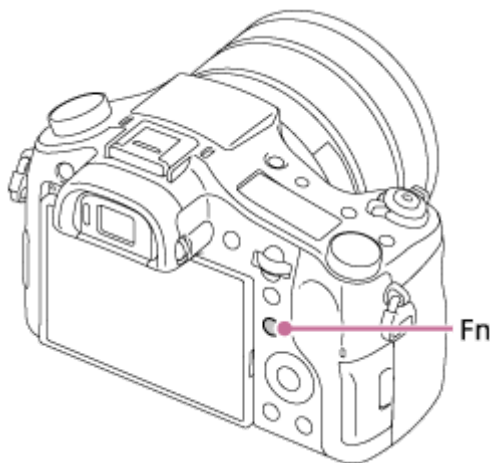

- 2 Select the desired function by pressing the top/bottom/left/right side of the control wheel.

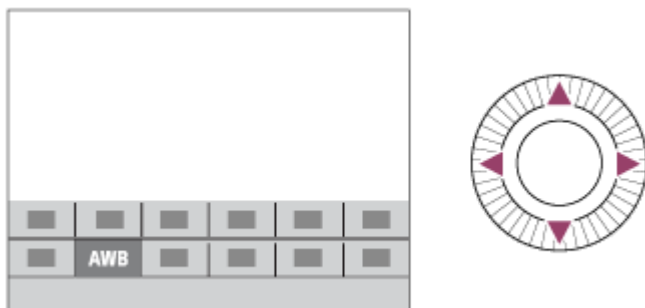

- 3 Select the desired setting by turning the control wheel, and press the center of the control wheel.

- Some functions can be fine-tuned using the control dial.

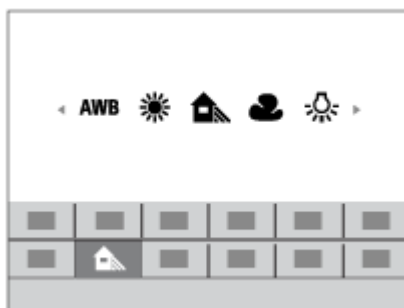

**To adjust settings from the dedicated setting screens**

Select the desired function in step 2, then press the center of the control wheel. The dedicated setting screen for the function will appear. Follow the operating guide **(A)** to adjust settings.

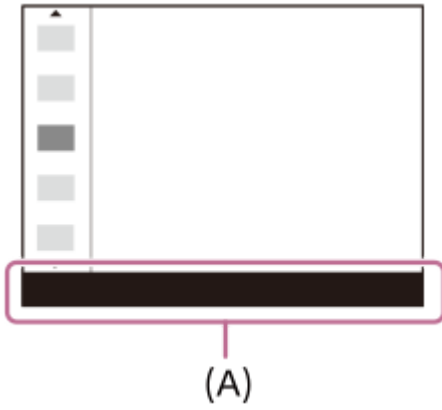



---

#### Related Topic

- [Function Menu Set.](#)

## How to use the Quick Navi screen

The Quick Navi screen is a function optimized for shooting with the viewfinder, that lets you control settings directly.

- 1 MENU →  (Camera Settings2) → [DISP Button] → [Monitor].
- 2 Place a  mark on [For viewfinder] and then select [Enter].
- 3 Press the DISP on the control wheel to set the screen mode to [For viewfinder].
- 4 Press the Fn button to switch to the Quick Navi screen.
  - The displayed contents and their positions in the illustrations are just guidelines, and may differ from the actual displays.

### Auto mode/Scene Selection mode



### P/A/S/M/Sweep Panorama mode



- 5 Select the desired function by pressing the top/bottom/left/right side of the control wheel.
- 6 Turn the control wheel to select the desired setting.
  - Some functions can be fine-tuned using the control dial.

### To adjust settings from the dedicated setting screens

Select the desired function in step 5, then press the center of the control wheel. The dedicated setting screen for the function will appear. Follow the operating guide (A) to adjust settings.

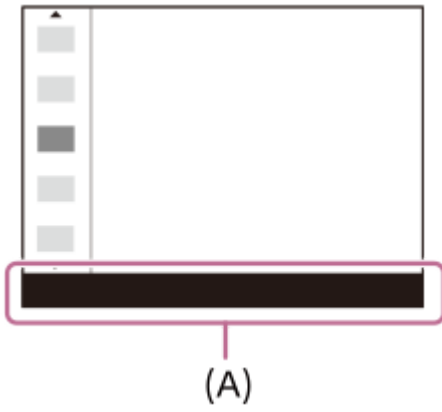

### Note

- Items that are gray on the Quick Navi screen are not adjustable.
- When using [Creative Style], [Picture Profile], etc., some of the setup tasks can only be accomplished on a dedicated screen.

---

### Related Topic

- [Switching the screen display \(while shooting/during playback\)](#)



## How to use the keyboard

When manual character entry is required, a keyboard is displayed on the screen.



Move the cursor on desired key using the control wheel, then press the center to enter.

### 1. Input box

The characters you entered are displayed.

### 2. Switch character types

Each time you press this key, the character type will switch between alphabet letters, numerals and symbols.

### 3. Keyboard

Each time you press this key, the characters corresponding to that key will be displayed one-by-one in order.

#### **For example: If you want to enter “abd”**

Press the key for “abc” once to display “a” → select “”((5) Move cursor) and press the key for “abc” twice to display “b” → press the key for “def” once to display “d.”

### 4. Finalize

Finalizes the entered characters.

### 5. Move cursor

Moves the cursor in the input box to the right or left.

### 6. Delete

Deletes the character preceding the cursor.

### 7.

Switches the next character to a capital or lowercase letter.

### 8.

Enters a space.

- To cancel input, select [Cancel].

## List of icons on the screen

The displayed contents and their positions shown below are just a guideline, and may differ from the actual display.

### Monitor mode

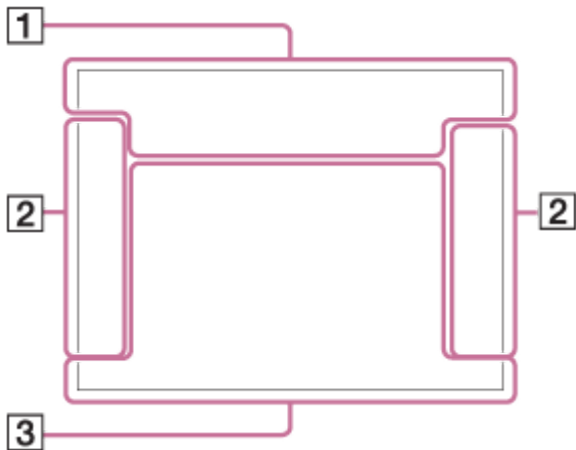

### Viewfinder mode

In Auto Mode or Scene Selection mode

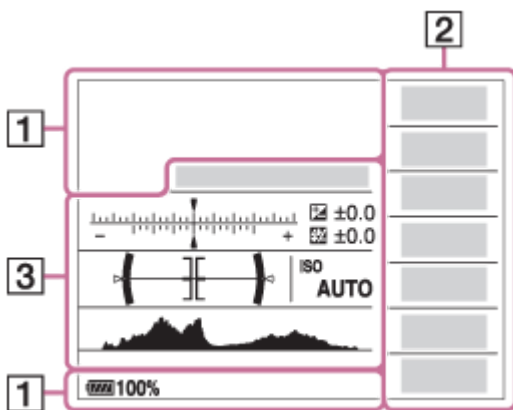

P/A/S/M/Sweep Panorama mode

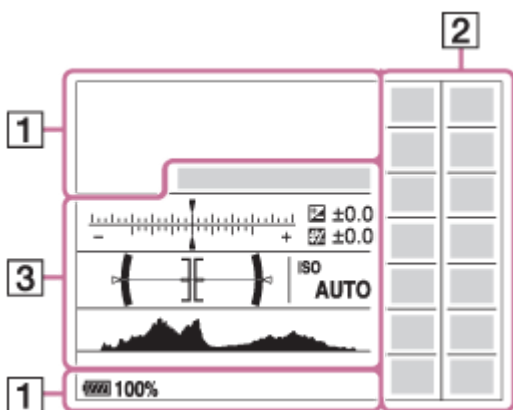

### For playback

## Basic information display



## Histogram display

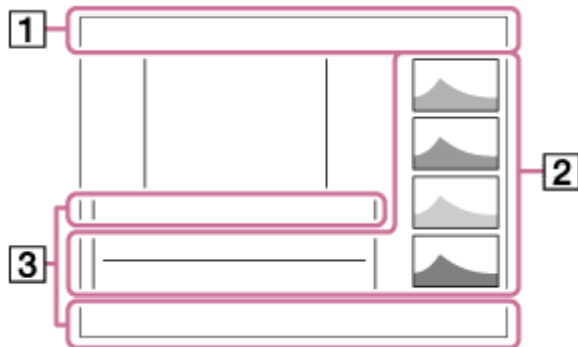

1. P P\* A S M

Shoot Mode

Memory recall

Scene Recognition icons

Scene Selection

NO CARD

Memory card status

100

Remaining number of recordable images

Aspect ratio of still images

20M / 18M / 17M / 13M / 10M / 7.5M / 6.5M / 5.0M / 4.2M / 3.7M / VGA

WIDE STD

Image size of still images

RAW RAW+J X.FINE FINE STD

Image quality of still images

120p 100p 60p 50p 60i 50i 30p 25p 24p

Frame rate of movies

Record setting of movies

Bluetooth connection available/Bluetooth connection unavailable

Connected to smartphone/Not connected to smartphone

100%

Remaining battery

Remaining battery warning



USB power supply



Flash charge in progress



AF Illuminator



Setting Effect OFF



NFC is activated



Airplane Mode



Overlay icon



No audio recording of movies

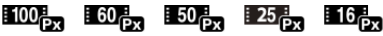

**Px** Proxy Recording



Wind Noise Reduct.



SteadyShot Off/On, Camera shake warning



Obtaining location information/Location information cannot be obtained



Overheating warning

**x2.0**

Smart teleconverter



Database file full/Database file error



Smart Zoom/ Clear Image Zoom/Digital Zoom



View Mode

**100-0003**

Folder number-File number



Protect

**XAVC S 4K XAVC S HD AVCHD**

File format of movies

**DPOF**

DPOF set



PC Remote



Bright Monitoring



Copyright information writing on

**240fps 250fps 480fps 500fps 960fps 1000fps**

Frame rate for HFR shooting



**HFR** REC Timing

Assist Assist  
5-Log2 5-Log3

Gamma Disp. Assist



Auto object framing image



Writing data/Number of images left to write

**CAPTURE**

Capturing still image



Unable to shoot Still images



Auto Dual Rec



Focus Cancel



Lock-on AF OFF

**Spot Focus**

Performing Spot Focus

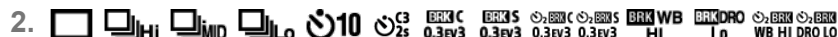

Drive Mode



Flash Mode/Red Eye Reduction



Flash Comp.



Focus Mode



Focus Area



Metering Mode

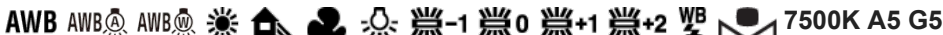

White Balance (Auto, Preset, Custom, Color temperature, Color filter)



D-Range Optimizer/Auto HDR



Creative Style/Contrast, saturation, and sharpness



Smile/Face Detect.

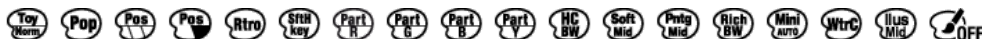

Picture Effect



Copyright information exists for image



Smile detection sensitivity indicator



Picture Profile

PEAK PEAK PEAK PEAK  
HI MID LO OFF

Peaking

3. ● Lock-on AF

Guide display for Center button Lock-on AF

● Select Focus Point On/Off

Guide display for setting Focus Area

● Focus Cancel

Guide display for setting Focus Cancel

▼▼▼  
-4 3 2 1 0 1 2+  
Bracket indicator



Exposure compensation/Metered Manual

**STBY**

Movie recording standby

**REC 1:00:12**

Actual movie recording time (hours: minutes: seconds)



Lens ring function



Control wheel function



Control dial function



Focus



Focus range limiter

**1/250**

Shutter speed

**F3.5**

Aperture Value

**ISO400**

**ISO AUTO**

ISO sensitivity



Exposure Setting Guide



AE lock



Shutter speed indicator



Aperture indicator



Histogram



Location information

**90°44'55"N**

**233°44'55"W**

Latitude/longitude information

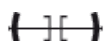

Digital level gauge

CH1   
CH2 

Audio level

**D-R OFF DRO HDR HDR !**

DRO/Auto HDR image warning



Picture Effect error

**2017-1-1**

**10:37AM**

Date of recording

**3/7**

File number/Number of images in the view mode



 REC Control



Spot metering area

**C:32:00**

Self-diagnosis display

**00:00:00:00**

Time code (hour:minute:second:frame)

**00 00 00 00**

User Bit

## Indicators on the display panel

You can set the shutter speed and aperture, exposure compensation, flash compensation, ISO, white balance, drive mode, etc., using the display panel on top of the camera.



### Shutter speed/Aperture

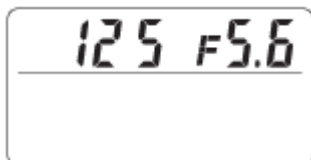

### Exposure compensation/Flash compensation

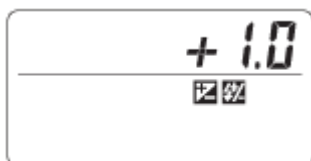

### ISO sensitivity

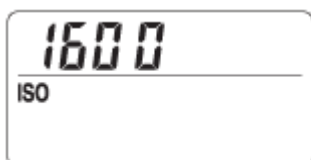

### White Balance

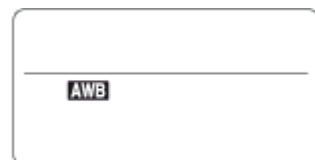

### Drive Mode



### Remaining battery





### Remaining number of recordable images\*



\* Even if the number of recordable images is higher than 9,999 images, "9999" will appear on the display panel.

### To turn on the display panel backlight

Press the  (Display panel illumination) button (A) on top of the camera. If you press the button again, the display panel backlight will turn off.

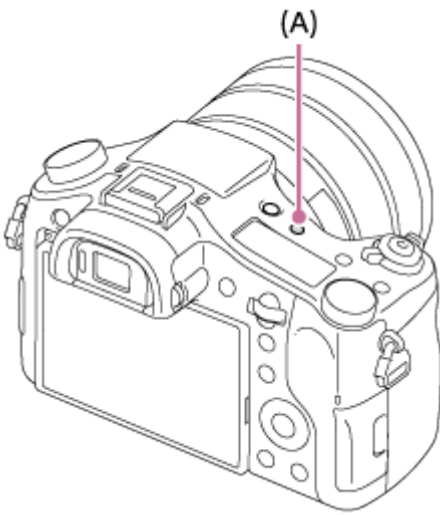

## Switching the screen display (while shooting/during playback)

You can change the display contents on the screen.

### 1 Press the DISP (Display Setting) button.

- To switch the information displayed on the viewfinder, press the DISP button while looking into the viewfinder.
- Each time you press the DISP button, the screen display changes.
- The displayed contents and their position are just a guideline, and may differ from the actual display.

#### During shooting (Monitor)

Display All Info. → No Disp. Info. → Histogram → Level → For viewfinder → Display All Info.

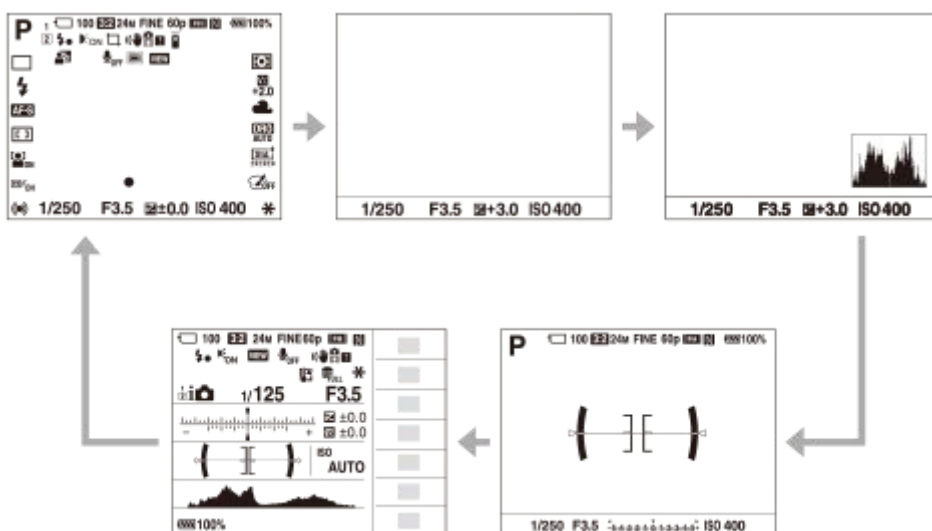

#### During shooting (Viewfinder)

Level → No Disp. Info. → Histogram → Level



#### During playback (Monitor/Viewfinder)

Display Info. → Histogram → No Disp. Info. → Display Info.

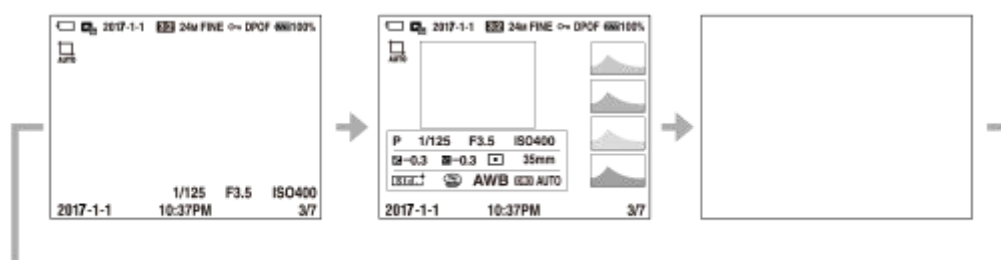

- If the image has an overexposed or underexposed area, the corresponding section will blink on the histogram display (overexposed/underexposed warning).
- The settings for playback are also applied in [Auto Review].

## Histogram display

A histogram shows the luminance distribution, displaying how many pixels there are by luminance. It shows darker toward the left and brighter toward the right.

The histogram changes depending on the exposure compensation.

A peak at the right or left end of the histogram indicates that the image has an overexposed or underexposed area, respectively. You cannot correct such defects using a computer after shooting. Perform exposure compensation before shooting as necessary.



(A): Pixel count  
(B): Brightness

### Note

- The viewfinder display and the monitor display for shooting can be set separately. Look through the viewfinder to set the display settings for the viewfinder.
- [Histogram] is not displayed during panorama shooting.
- The information in the histogram display does not indicate the final photograph. It is information about image displayed on the screen. The final result depends on the aperture value, etc.
- The histogram display is extremely different between shooting and playback in the following cases:
  - When the flash is used
  - When shooting a low luminance subject such as a night scene
- In movie mode, [For viewfinder] cannot be displayed.

### Hint

- The following are not displayed in the default settings.
  - Graphic Display
  - Display All Info. (when using the viewfinder)

To change the display modes that are switched when you press the DISP button, select MENU → 2 (Camera Settings2) → [DISP Button] and change the setting.

- DISP Button (Monitor/Finder)

4-725-901-11(2) Copyright 2017 Sony Corporation

Digital Still Camera  
DSC-RX10M4

## DISP Button (Monitor/Finder)

Allows you to set the screen display modes that can be selected using DISP (Display Setting) in shooting mode.

1 MENU →  2 (Camera Settings2) → [DISP Button] → [Monitor] or [Finder] → desired setting → [Enter].

The items marked with  are available.

### Menu item details

#### Graphic Display :

Shows basic shooting information. Graphically shows the shutter speed and aperture value.

#### Display All Info. :

Shows recording information.

#### No Disp. Info. :

Does not show recording information.

#### Histogram :

Displays the luminance distribution graphically.

#### Level :

Indicates whether the product is level in both the front-back **(A)** and horizontal **(B)** directions. When the product is level in both directions, the indicator turns to green.

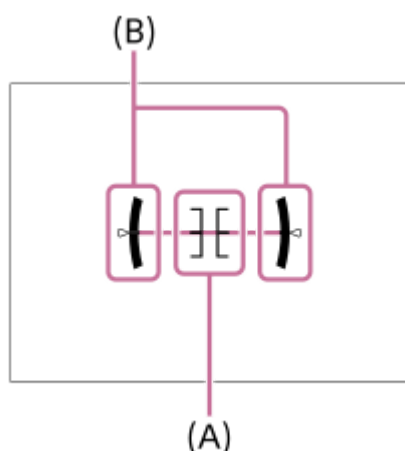

#### For viewfinder\*:

Displays information suited for shooting with the viewfinder.

\* This screen mode is available only in the setting for [Monitor].

#### Note

- If you tilt the product forward or backward by a large degree, the level error will be great.
- The product may have a margin of error of almost  $\pm 1^\circ$  even when the inclination is corrected by the level.

### Related Topic

- [Switching the screen display \(while shooting/during playback\)](#)



Digital Still Camera  
DSC-RX10M4

## Checking the camera and the supplied items

---

The number in parentheses indicates the number of pieces.

- Camera (1)
- Power cord (mains lead) (1)\* (supplied in some countries/regions)

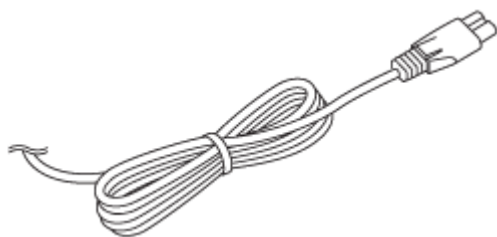

- Rechargeable Battery Pack NP-FW50 (1)

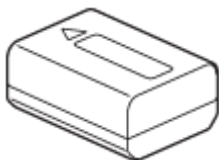

- Micro USB cable (1)

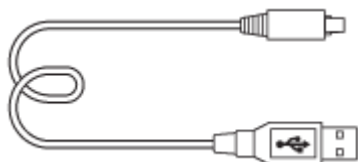

- AC Adaptor (1)  
The shape of the AC Adaptor may differ depending on the country/region.

- Shoulder Strap (1)

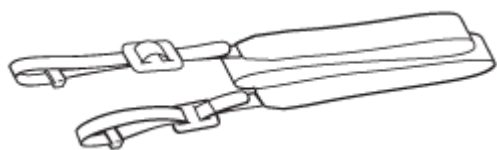

- Lens cap (1)



- Lens Hood (1)



- Eyepiece Cup (1) (attached on the camera)
- Shoe Cap (1) (attached on the camera)
- Instruction Manual (1)
- Reference Guide (1)
- Wi-Fi Connection/One-touch (NFC) Guide (1)

4-725-901-11(2) Copyright 2017 Sony Corporation



## Inserting/removing the battery pack

- 1 Open the battery cover.

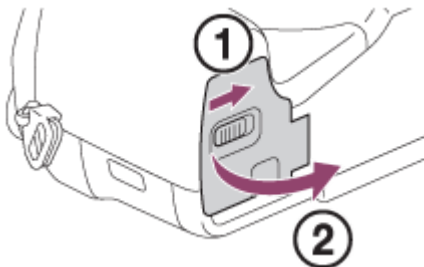

- 2 Insert the battery pack while pressing the lock lever (A) with the tip of the battery until the battery locks into place.

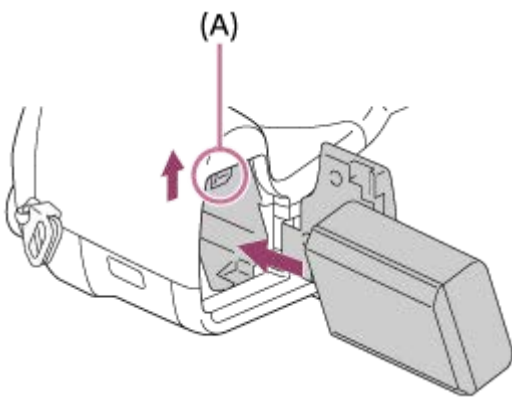

- 3 Close the cover.

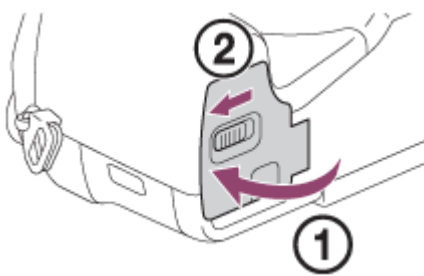

### To remove the battery pack

Make sure that the access lamp is not lit, and turn off the camera. Then, slide the lock lever (A) and remove the battery pack.

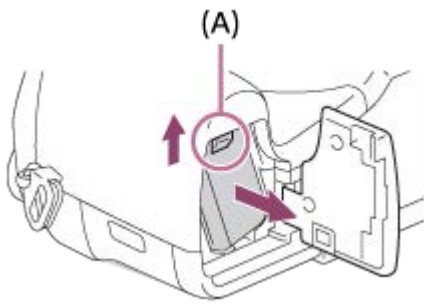

4-725-901-11(2) Copyright 2017 Sony Corporation

## Charging the battery pack while it is inserted in the camera

- 1 Turn the power off.
- 2 Connect the camera with the battery pack inserted to the AC Adaptor (supplied) using the micro USB cable (supplied), and connect the AC Adaptor to the wall outlet (wall socket).

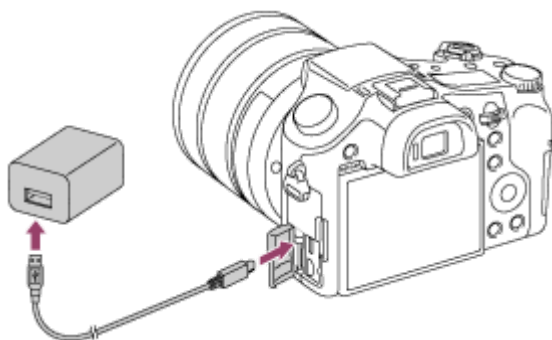

### Charge lamp on the camera (orange)

Lit: Charging

Off: Charging finished

Flashing: Charging error or charging paused temporarily because the camera is not within the proper temperature range

- Charging time (Full charge): The charging time is approximately 150 min.
- The above charging time applies when charging a fully depleted battery pack at a temperature of 25 °C (77 °F). Charging may take longer depending on conditions of use and circumstances.
- The charge lamp turns off when charging is completed.
- If the charge lamp lights up and then immediately turns off, the battery pack is fully charged.

### Note

- If the charge lamp flashes when the battery pack is not fully charged, remove the battery pack or disconnect the USB cable from the camera and then re-insert it to recharge.
- If the charge lamp on the camera flashes when the AC Adaptor is connected to the wall outlet (wall socket), this indicates that charging is temporarily stopped because the temperature is outside the recommended range. When the temperature gets back within the appropriate range, the charging resumes. We recommend charging the battery pack at an ambient temperature of between 10°C to 30°C (50°F to 86°F).
- Use a nearby wall outlet (wall socket) when using the AC Adaptor/Battery Charger. If any malfunction occurs, disconnect the plug from the wall outlet (wall socket) immediately to disconnect from the power source.  
If you use the product with a charge lamp, note that the product is not disconnected from the power source even when the lamp turns off.
- If you turn on the camera, power will be supplied from the wall outlet (wall socket) and you will be able to operate the camera. However, the battery pack will not be charged.
- When you use a completely new battery pack or a battery pack that has not been used for a long time, the charge lamp may flash quickly when the battery is charged. If this happens, remove the battery pack or disconnect the USB cable from the camera and then re-insert it to recharge.
- Do not continuously or repeatedly charge the battery pack without using it if it is already fully charged or close to fully charged. Doing so may cause a deterioration in battery performance.

- When charging is finished, disconnect the AC Adaptor from the wall outlet (wall socket).
- Be sure to use only genuine Sony brand battery packs, micro USB cables (supplied) and AC Adaptors (supplied).

---

---

### Related Topic

- [Notes on the battery pack](#)
- [Notes on charging the battery pack](#)
- [Using the AC Adaptor/battery charger abroad](#)

4-725-901-11(2) Copyright 2017 Sony Corporation

## Charging by connecting to a computer

The battery pack can be charged by connecting the camera to a computer using a micro USB cable.

- 1 Turn off the product, and connect to the USB terminal of the computer.

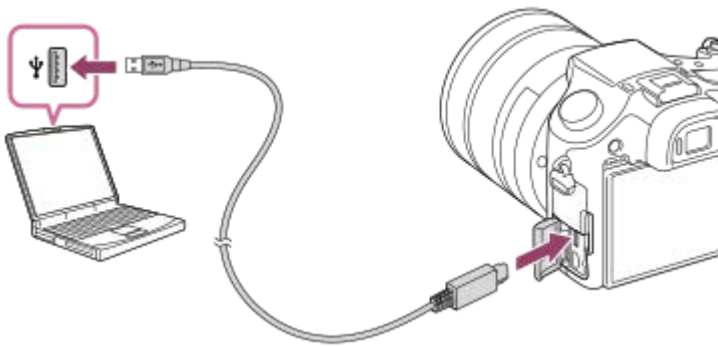

### Note

- If the product is connected to a laptop computer that is not connected to a power source, the laptop battery level decreases. Do not leave the product connected to a laptop computer for an extended period of time.
- Do not turn on/off or restart the computer, or wake the computer from sleep mode when a USB connection has been established between the computer and the camera. Doing so may cause a malfunction. Before turning on/off or restarting the computer, or waking the computer from sleep mode, disconnect the camera from the computer.
- Proper operation cannot be guaranteed on all types of computers.
- Charging cannot be guaranteed with a custom-built computer, modified computer, or a computer connected through a USB hub.
- The camera may not operate correctly when other USB devices are used at the same time.

### Related Topic

- [Notes on the battery pack](#)
- [Notes on charging the battery pack](#)

## Battery life and number of recordable images

		Battery life	Number of images
Shooting (still images)	Screen mode	-	Approx. 400
	Viewfinder mode	-	Approx. 370
Actual shooting (movies)	Screen mode	Approx. 75 min.	-
	Viewfinder mode	Approx. 75 min.	-
Continuous shooting (movies)	Screen mode	Approx. 135 min.	-
	Viewfinder mode	Approx. 135 min.	-

### Note

- The above estimates for battery life and number of recordable images apply when the battery pack has been fully charged. The battery life and number of images may decrease depending on the conditions of use.
- The battery life and number of recordable images are estimates based on shooting with the default settings under the following conditions:
  - Using the battery pack at an ambient temperature of 25°C (77°F).
  - Using a Sony SDXC memory card (U3) (sold separately)
- The numbers for “Shooting (still images)” are based on the CIPA standard and shooting under the following conditions: (CIPA: Camera & Imaging Products Association)
  - One picture is taken every 30 seconds.
  - The power is turned on and off once every ten times.
  - The flash strobos once for every two pictures.
  - The zoom is switched alternately between the W and T ends.
- The number of minutes for movie shooting is based on the CIPA standard and shooting under the following conditions:
  - The image quality is set to XAVC S HD 60p 50M /50p 50M.
  - Actual shooting (movies): Battery life based on repeated shooting, zooming, shooting stand-by, turning on/off, etc.
  - Continuous shooting (movies): Battery life based on non-stop shooting until the limit (29 minutes) has been reached, and then continued by pressing the MOVIE (Movie) button again. Other functions, such as zooming, are not operated.

Digital Still Camera  
DSC-RX10M4

## Supplying power from a wall outlet (wall socket)

Use the supplied AC adaptor to shoot and play back images while power is supplied from a wall outlet (wall socket). This conserves the camera's battery power.

- 1 **Insert the battery pack into the camera.**
- 2 **Connect the camera to the wall outlet (wall socket) with a micro USB cable (supplied) and an AC adaptor (supplied).**

### Note

- The camera will not activate if there is no remaining battery. Insert a sufficiently charged battery pack into the camera.
- If you use the camera while power is being supplied from a wall outlet (wall socket), make sure that the icon (  ) is displayed on the monitor.
- Do not remove the battery pack while power is supplied from a wall outlet (wall socket). If you remove the battery pack, the camera will be turned off.
- Do not remove the battery pack while the access lamp is lit. The data in the memory card may be damaged.
- As long as the power is on, the battery pack will not be charged even if the camera is connected to the AC Adaptor.
- Under certain conditions, power may be supplied from the battery pack supplementarily even if you are using the AC adaptor.
- Do not remove the Micro USB cable while power is supplied from a wall outlet (wall socket). Before you remove the Micro USB cable, turn off the camera.
- Depending on the camera and battery temperature, the continuous recording time may be shortened while power is supplied from a wall outlet (wall socket).
- When using a mobile charger as a power source, confirm that it is fully charged before use. Also, be careful of the remaining power on the mobile charger during use.

## Notes on the battery pack

### Notes on using the battery pack

- Be sure to use only battery packs specified for this product.
- The correct remaining battery indicator may not be displayed under some operating or environmental conditions.
- Do not expose the battery pack to water. The battery pack is not water-resistant.
- Do not leave the battery pack in extremely hot places, such as in a car or under direct sunlight.

### Charging the battery pack

- Charge the battery pack (supplied) before using the product for the first time.
- The charged battery pack will discharge little by little even if you do not use it. Charge the battery pack each time before you use the product so that you do not miss any opportunities to shoot images.
- Do not charge battery packs except battery packs specified for this product. Doing so can result in leaks, overheating, explosions, electric shocks, burns, or injuries.
- If the charge lamp flashes when the battery pack is not fully charged, remove the battery pack or disconnect the USB cable from the camera and then reinsert it to recharge.
- We recommend charging the battery pack in an ambient temperature of between 10 °C and 30 °C (50 °F and 86 °F). The battery pack may not be effectively charged in temperatures outside this range.
- When you connect this product and a laptop computer that is not connected to a power source, the laptop's battery charge may decrease. Do not charge this product using the laptop computer for too long.
- Do not turn on/restart a computer, wake a computer from sleep mode, or turn off a computer while this product is connected to the computer via USB cable. Doing so may cause a malfunction of this product. Disconnect the product and the computer before performing the above operations.
- We do not guarantee charging if you are using a self-built or modified computer.
- When charging is finished, disconnect the AC Adaptor from the wall outlet (wall socket) or disconnect the USB cable from the camera. Not doing so may result in a shorter battery life.

### Remaining battery indicator

- The remaining battery indicator appears on the screen.



- A:** Battery level high  
**B:** Battery exhausted

- It takes about one minute for the correct remaining battery indicator to appear.
- The correct remaining battery indicator may not be displayed under some operating or environmental conditions.
- If the remaining battery indicator does not appear on the screen, press the DISP (Display Setting) button to display it.

### Charging time (Full charge)

The charging time is approximately 150 minutes using the AC adaptor (supplied).

The above charging time applies when charging a fully depleted battery pack at a temperature of 25 °C (77 °F). Charging may take longer depending on conditions of use and circumstances.

### Effective use of the battery pack



- Battery performance decreases in low temperature environments. So in cold places, the operational time of the battery pack is shorter. To ensure longer battery pack use, we recommend putting the battery pack in your pocket close to your body to warm it up, and insert it in the product immediately before you start shooting. If there are any metal objects such as keys in your pocket, be careful of causing a short-circuit.
- The battery pack will run down quickly if you use the flash or continuous shooting function frequently, turn the power on/off frequently, or set the monitor very bright.
- We recommend preparing spare battery packs and taking trial shots before taking the actual shots.
- If the battery terminal is dirty, you may not be able to turn on the product or the battery pack may not be properly charged. In that case, clean the battery by lightly wiping off any dust using a soft cloth or a cotton swab.

## **How to store the battery pack**

To maintain the battery pack's function, charge the battery pack and then fully discharge it in the camera at least once a year before storing it. Store the battery in a cool, dry place after removing it from the camera.

## **On battery life**

- The battery life is limited. If you use the same battery repeatedly, or use the same battery for a long period, the battery capacity decreases gradually. If the available time of the battery is shortened significantly, it is probably time to replace the battery pack with a new one.
- The battery life varies according to how the battery pack is stored and the operating conditions and environment in which each battery pack is used.

## Notes on charging the battery pack

---

- The supplied AC Adaptor is dedicated to this product. Do not connect with other electronic devices. Doing so may cause a malfunction.
- Make sure to use a genuine Sony AC Adaptor.
- If the product's charge lamp flashes while charging, remove the battery pack being charged, and then insert the same battery pack firmly back into the product. If the charge lamp flashes again, this may indicate a faulty battery or that a battery pack other than the specified type has been inserted. Check that the battery pack is the specified type. If the battery pack is the specified type, remove the battery pack, replace it with a new or different one and check that the newly inserted battery is charging correctly. If the newly inserted battery is charging correctly, the previously inserted battery may be faulty.
- If the charge lamp flashes even if the AC Adaptor is connected to the product and the wall outlet (wall socket), this indicates that charging has stopped temporarily and is on standby. Charging stops and enters standby status automatically when the temperature is outside of the recommended operating temperature. When the temperature returns to the appropriate range, charging resumes and the charge lamp lights up again. We recommend charging the battery pack in an ambient temperature of between 10°C to 30°C (50°F to 86°F).

## Inserting/removing a memory card

Explains how to insert a memory card (sold separately) to the product.

### 1 Open the memory card cover.

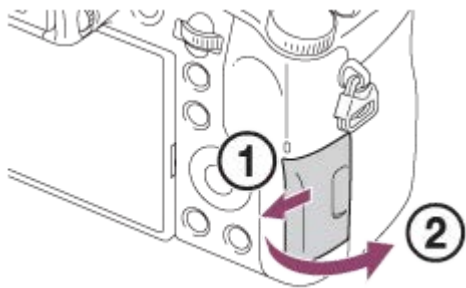

### 2 Insert the memory card.

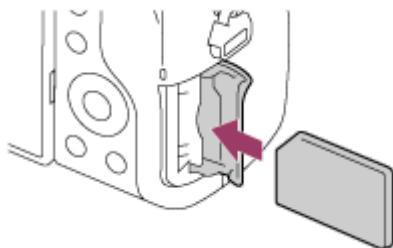

- With the notched corner facing in the direction illustrated, insert the memory card until it clicks into place. Insert the memory card correctly. Not doing so may cause a malfunction.

### 3 Close the cover.

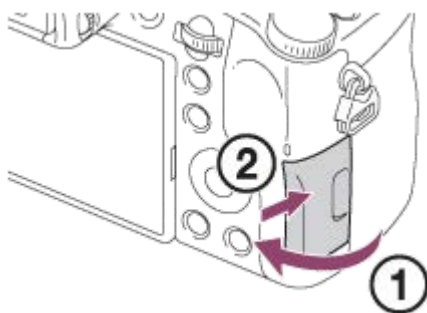

#### Hint

- When you use a memory card with the camera for the first time, it is recommended that you format the card on the camera for more stable performance of the memory card.

### To remove the memory card

Open the memory card cover and make sure that the access lamp **(A)** is not lit, then push in the memory card lightly once to remove it.

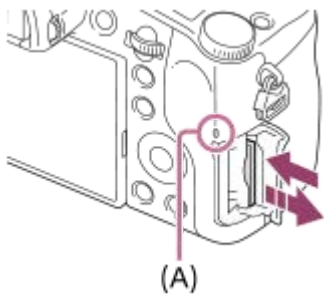

---

### Related Topic

- [Memory cards that can be used](#)
- [Notes on memory card](#)
- [Format](#)

4-725-901-11(2) Copyright 2017 Sony Corporation

Digital Still Camera  
DSC-RX10M4

## Memory cards that can be used

When using microSD memory cards or Memory Stick Micro media with this camera, be sure to use the appropriate adaptor.

### SD memory cards

Recording format		Supported memory card
Still image		SD/SDHC/SDXC card
AVCHD		SD/SDHC/SDXC card (Class 4 or faster, or U1 or faster)
XAVC S	4K 60Mbps* HD 50Mbps or lower* HD 60Mbps	SDHC/SDXC card (Class 10, or U1 or faster)
	4K 100Mbps* HD 100Mbps	SDHC/SDXC card (U3)
	High Frame Rate*	SDHC/SDXC card (Class 10, or U1 or faster)

\* Including when recording proxy movies at the same time

### Memory Stick media

Recording format		Supported memory card
Still image		Memory Stick PRO Duo/ Memory Stick PRO-HG Duo
AVCHD		Memory Stick PRO Duo (Mark 2)/ Memory Stick PRO-HG Duo
XAVC S	4K 60Mbps* HD 50Mbps or lower* HD 60Mbps	Memory Stick PRO-HG Duo
	4K 100Mbps* HD 100Mbps	—
	High Frame Rate*	Memory Stick PRO-HG Duo

\* Including when recording proxy movies at the same time

#### Note

- When an SDHC memory card is used to record an XAVC S movie over extended periods of time, the recorded movies will be divided into files 4 GB in size. The divided files can be handled as a single file by importing them to a computer using PlayMemories Home.
- Fully charge the battery pack before attempting to recover the database files on the memory card.

### Related Topic

- [Notes on memory card](#)

- Number of recordable images
- Recordable movie times

4-725-901-11(2) Copyright 2017 Sony Corporation

## Notes on memory card

---

- If you repeatedly shoot and delete images for a long time, fragmentation of data in a file in the memory card may occur, and movie recording may be interrupted in the middle of shooting. If this happens, save your images to a computer or other storage location, then execute [Format] using this camera.
- Do not remove the battery pack or the memory card, disconnect the USB cable, or turn the camera off while the access lamp is lit up. This may cause the data on the memory card to become damaged.
- Be sure to back up the data for protection.
- Not all memory cards are guaranteed to operate correctly.
- Images recorded on an SDXC memory card cannot be imported to or played on computers or AV devices that are not compatible with exFAT when connected using a micro USB cable. Make sure that the device is compatible with exFAT before connecting it to the camera.  
If you connect your camera to an incompatible device, you may be prompted to format the card. Never format the card in response to this prompt, as doing so will erase all data on the card.  
(exFAT is the file system used on SDXC memory cards.)
- Do not expose the memory card to water.
- Do not strike, bend or drop the memory card.
- Do not use or store the memory card under the following conditions:
  - High temperature locations such as in a car parked under the sun
  - Locations exposed to direct sunlight
  - Humid locations or locations with corrosive substances present
- If the memory card is used near areas with strong magnetization, or used in locations subject to static electricity or electrical noise, the data on the memory card may become damaged.
- Do not touch the terminal section of the memory card with your hand or a metal object.
- Do not leave the memory card within the reach of small children. They might accidentally swallow it.
- Do not disassemble or modify the memory card.
- The memory card may be hot just after it has been used for a long time. Be careful when you handle it.
- Memory card formatted with a computer is not guaranteed to operate with the product. Format the memory card using this product.
- Data read/write speeds differ depending on the combination of the memory card and the equipment used.
- Do not press down hard when writing in the memo space on the memory card.
- Do not attach a label on the memory card itself nor on a memory card adaptor.
- If the write-protect switch or delete-protect switch of a memory card is set to the LOCK position, you cannot record or delete images. In this case, set the switch to the record position.
- To use a Memory Stick Micro media or microSD memory card with this product:
  - Be sure to insert the memory card into a dedicated adaptor. If you insert a memory card into the product without a memory card adaptor, you might not be able to remove it from the product.
  - When inserting a memory card into a memory card adaptor, be sure that the memory card is inserted in the correct direction and then insert it as far as it will go. If the card is not inserted properly, it may result in a malfunction.
- About Memory Stick PRO Duo media and Memory Stick PRO-HG Duo media:
  - This Memory Stick is equipped with MagicGate function. MagicGate is copyright protection technology that uses encryption technology.  
Data recording/playback that requires MagicGate functions cannot be performed with this product.
  - High-speed data transfer using a parallel interface is supported.

## Attaching the lens hood

We recommend that you use the lens hood to prevent light outside the shooting frame from affecting the image.

- 1 Match the shape of the lens hood mounting part and lens head, and turn the lens hood clockwise until it clicks.

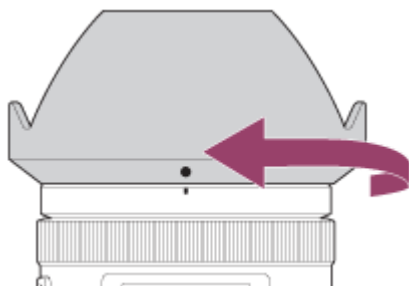

### Note

- Attach the lens hood properly. Otherwise, the lens hood may not have any effect or may be partially reflected in the image.
- When the lens hood is attached properly, the lens hood index (red line) matches the red index mark on the hood.
- Remove the lens hood when using the flash as the lens hood blocks the flash light and may appear as a shadow on the image.
- To store the lens hood after shooting, attach the lens hood to the lens backward.



## Setting language, date and time

The setting screen for language, date and time is displayed automatically when you turn on this product for the first time, initialize this product or when the internal rechargeable backup battery has discharged.

- 1 Turn on the camera.**

The language setting screen will appear and then setting screen for date and time will appear.
- 2 Select your language, and then press the center of the control wheel.**
- 3 Check that [Enter] is selected on the screen, then press the center.**
- 4 Select your desired geographic location, and then press the center.**
- 5 Select a setting item using the top/bottom side of the control wheel or by turning the control wheel, then press the center.**
- 6 Set [Daylight Savings], [Date/Time], and [Date Format] using the top/bottom/left/right sides, then press the center.**
  - Midnight is indicated as 12:00 AM, and noon as 12:00 PM when you set [Date/Time].
  - Change the values using the top/bottom when you set [Date/Time].
- 7 Repeat Steps 5 and 6 to set other items, then select [Enter] and press the center.**

### On maintaining the date and time

This camera has an internal rechargeable battery for maintaining the date and time and other settings regardless of whether the power is on or off, or whether the battery pack is charged or discharged.

To charge the internal rechargeable backup battery, insert a charged battery pack into the camera, and leave the product for 24 hours or more with the power off.

If the clock resets every time the battery pack is charged, the internal rechargeable backup battery may be worn out. Consult your service facility.

#### Hint

- To set the date and time or geographic location again after the date and time setting is finished, select MENU →  (Setup) → [Date/Time Setup] or [Area Setting].

#### Note

- If the date and time setting is canceled halfway, the setting screen for the date and time appears every time you turn on the camera.

---

### Related Topic

- Date/Time Setup
- Area Setting
- Using the control wheel

4-725-901-11(2) Copyright 2017 Sony Corporation

## In-Camera Guide

---

The [In-Camera Guide] displays descriptions of MENU items, Fn (Function) items, and settings. Assign the [In-Camera Guide] function to the desired key in advance using [Custom Key(Shoot.)].

- 1 MENU →  2 (Camera Settings2) → [Custom Key(Shoot.)] → desired key, then assign the [In-Camera Guide] function to the key.**
  - The [In-Camera Guide] function cannot be assigned to some keys.
- 2 Select the MENU or Fn item of which you want to see descriptions, then press the button to which the [In-Camera Guide] function is assigned.**

The descriptions of the item are displayed.

---

### Related Topic

- [Custom Key\(Shoot.\)/Custom Key\(PB\)](#)

## Shooting still images

- 1 Select the desired shooting mode by turning the mode dial.

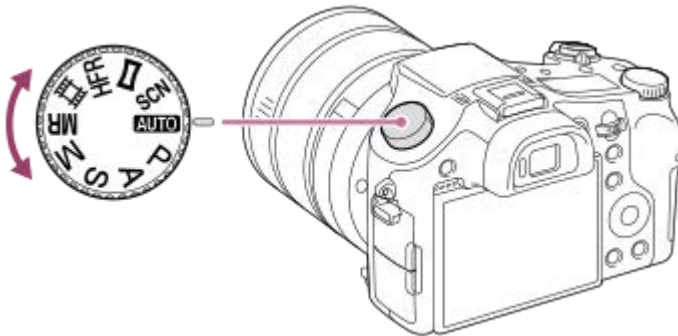

- 2 Adjust the monitor angle, and hold the camera. Or look through the viewfinder and hold the camera.
- 3 Enlarge images with the W/T (zoom) lever when shooting.
- 4 Press the shutter button halfway down to focus.

When the image is in focus, a beep sounds and the indicator (such as ●) lights up.

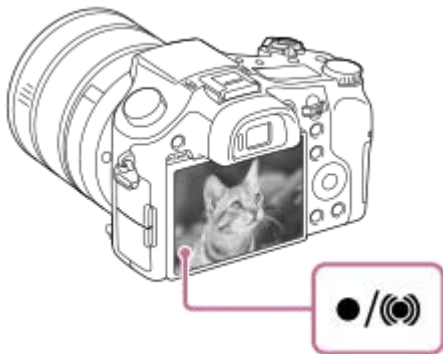

- The shortest shooting distance from the front of the lens is approximately 3 cm (0.10 ft.) at the wide-angle end, approximately 72 cm (2.36 ft.) at the telephoto end, and approximately 140 cm (4.59 ft.) at a focal length of around 250 mm (35 mm-equivalent).

- 5 Press the shutter button fully down.

### To shoot images with the focus locked on the desired subject (Focus-lock)

Shoots images with the focus locked on the desired subject in auto focus mode.

1. Turn the focus mode dial to select S (Single-shot AF) or A (Automatic AF).
2. Place the subject within the AF area and press the shutter button halfway down.



The focus is locked.

- If it is difficult to focus on the desired subject, set [Focus Area] to [Center] or [Flexible Spot].

3. Keep pressing the shutter button halfway down, and place the subject back in the original position to re-compose the shot.



4. Press the shutter button down fully to take the picture.

#### Hint

- When the product cannot focus automatically, the focus indicator flashes and the beep does not sound. Either re-compose the shot or change the focus setting. In [Continuous AF] mode,  lights up and the beep indicating that the focus has been achieved does not sound.

#### Note

- When the subject is moving, you cannot lock the focus even if [Focus Mode] has been set to [Automatic AF].

---

#### Related Topic

- [List of mode dial function](#)
- [Zoom](#)
- [Playing back still images](#)
- [Auto Review](#)
- [Focus Mode](#)
- [Focus Area](#)

Digital Still Camera  
DSC-RX10M4

## Focus Mode

Selects the focus method to suit the movement of the subject.

- 1 Turn the focus mode dial (A) and select the desired mode.

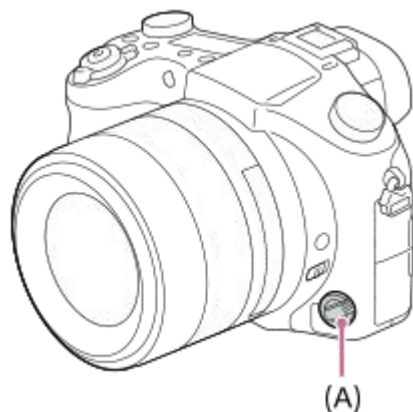

### Setting details

#### **S (Single-shot AF):**

The product locks the focus once focusing is complete. Use this when the subject is motionless.

#### **A (Automatic AF):**

[Single-shot AF] and [Continuous AF] are switched according to the movement of the subject. When the shutter button is pressed halfway down, the product locks the focus when it determines that the subject is motionless, or continues to focus when the subject is in motion. During continuous shooting, the product automatically shoots with Continuous AF from the second shot.

#### **C (Continuous AF):**

The product continues to focus while the shutter button is pressed and held halfway down. Use this when the subject is in motion. In [Continuous AF] mode, there is no beep when the camera focuses.

#### **DMF (DMF):**

You can make fine adjustments manually after performing auto focusing, letting you focus on a subject more quickly than when using the manual focus from the beginning. This is convenient in situations such as macro shooting.

#### **MF (Manual Focus):**

Adjusts the focus manually. If you cannot focus on the intended subject using auto focus, use manual focus.

- Rotate the front lens ring to adjust the focus manually in the direct manual focus mode or manual focus mode.

### Focus indicator



(lit):

The subject is in focus and the focus is locked.



(flashing):

The subject is not in focus.



(lit):

The subject is in focus. The focus will be adjusted continuously according to the movements of the subject.

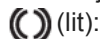

(lit):

Focusing is in progress.

### Focus range limiter

When the focus range limiter switch is set to "∞-3m," the camera focuses on subjects more than 3 m away in telephoto shooting (shooting with a 35 mm-equivalent focal length of 150 mm or longer). This function allows the camera to focus

more quickly on distant subjects by keeping it from focusing on subjects at close distances in telephoto shooting. An icon indicating the status of the focus range limiter is displayed on the monitor.

**FULL** : The focus range limiter is not applied. The camera focuses anywhere within entire shooting distance.

**LIMIT** : The focus range limiter is applied. The camera focuses within a limited range from approximately 3 m to infinity.

- When the focus range limiter switch is set to "∞-3m" in non-telephoto shooting (shooting with a 35 mm-equivalent focal length of less than 150 mm), **FULL** appears, and the camera focuses anywhere within entire shooting distance.

### Subjects on which it is difficult to focus using auto focus

- Dark and distant subjects
- Subjects with poor contrast
- Subjects seen through glass
- Fast-moving subjects
- Reflective light or shiny surfaces
- Flashing light
- Back-lit subjects
- Continuously repetitive patterns, such as the facades of buildings
- Subjects in the focusing area with different focal distances

#### Hint

- In [Continuous AF] mode, you can lock the focus by pressing and holding the focus hold button.
- When you set the focus to infinity in the manual focus mode or the direct manual focus mode, make sure that the focus is on a sufficiently distant subject by checking the monitor or the viewfinder.

#### Note

- Even if the focus mode dial is set to S, A, or DMF, the focus mode will switch to [Continuous AF] when shooting movies or when the mode dial is set to **HFR**.
- Depending on the usage conditions, even if the focus range limiter switch is set to "∞ - 3 m," the shortest shooting distance may be slightly smaller or greater than 3 m.

---

### Related Topic

- [Direct manual focus \(DMF\)](#)
- [Manual Focus](#)
- [MF Assist \(still image\)](#)

Digital Still Camera  
DSC-RX10M4

## Focus Area

Selects the focusing area. Use this function when it is difficult to focus properly in the auto focus mode.

1 MENU →  (Camera Settings1) → [Focus Area] → desired setting.

### Menu item details

#### Wide :

Focuses on a subject covering the whole range of the screen automatically. When you press the shutter button halfway down in the still image shooting mode, a green frame is displayed around the area that is in focus.

#### Center :

Focuses automatically on a subject in the center of the image. Use together with the focus-lock function to create the composition you want.

#### Flexible Spot :

Allows you to move the focusing frame to a desired point on the screen and focus on an extremely small subject in a narrow area.

On the Flexible Spot shooting screen, you can change the size of the focusing frame by turning the control wheel.

#### Expand Flexible Spot :

If the product cannot focus on a single selected point, it uses focus points around the flexible spot as a secondary priority area for focusing.



#### Lock-on AF :

When the shutter button is pressed and held halfway down, the product tracks the subject within the selected autofocus area. This setting is available only when the focus mode is set to [Continuous AF]. Point the cursor at [Lock-on AF] on the [Focus Area] setting screen, and then select the desired area to start tracking using the left/right sides of the control wheel. You can also move the tracking start area to the desired point by designating the area as a flexible spot or expand flexible spot. On the Flexible Spot shooting screen, you can change the size of the focusing frame by turning the control wheel.

### To move the focus area

- When [Focus Area] is set to [Flexible Spot] or [Expand Flexible Spot], if pressing the button to which [Focus Standard] is assigned, you can shoot while moving the focusing frame using the top/bottom/left/right sides of the control wheel. To change the shooting settings using the control wheel, press the button to which [Focus Standard] is assigned.
- You can move the focusing frame quickly by touching and dragging it on the monitor. Set [Touch Operation] to other than [Off] beforehand.

#### Note

- [Focus Area] is locked to [Wide] in the following situations:
  - [Intelligent Auto]
  - [Superior Auto]
  - [Scene Selection]
  - During Smile Shutter mode
  - The mode dial is set to  (Movie) and [Auto Dual Rec] is set to [On].
- The focus area may not light up during continuous shooting or when the shutter button is pressed all the way down at once.
- When the mode dial is set to  (Movie) or during movie shooting, [Lock-on AF] cannot be selected as the [Focus Area].
- You cannot perform functions assigned to the control wheel or the custom button 3 while moving the focusing frame.



---

---

## Related Topic

- [Touch Operation](#)
- [Adjusting the focus area settings to the camera's orientation \(horizontal/vertical\) \(Sw. V/H AF Area\)](#)
- [Registering the current focus area \(AF Area Regist.\)](#)

4-725-901-11(2) Copyright 2017 Sony Corporation



Digital Still Camera  
DSC-RX10M4

## Phase detection AF

---

When there are phase detection AF points within the auto focus area, the product uses the combined autofocus of the phase detection AF and contrast AF.

### Note

- When the F-value is greater than F8, you cannot use the Phase Detection AF. Only Contrast AF is available.
- When [  File Format] is set to [XAVC S HD] and [  Record Setting] is set to [120p]/[100p], Phase Detection AF cannot be used. Only Contrast AF is available.

## Focus Standard

---

If you assign [Focus Standard] to the desired custom key, you can recall useful functions such as moving the focusing frame quickly, etc., depending on the focus area settings.

- 1 MENU →  2 (Camera Settings2) → [Custom Key(Shoot.)] → desired button, then assign the [Focus Standard] function to the button.
- 2 Press the key to which [Focus Standard] is assigned.
  - What you can do by pressing the key varies depending on the settings for [Focus Area] and [Center Lock-on AF].

### When [Focus Area] is set to [Flexible Spot] or [Expand Flexible Spot]:

Pressing the key moves the position of the focusing frame using the top/bottom/left/right sides of the control wheel.

### When [Focus Area] is set to [Wide] or [Center]:

- When [Center Lock-on AF] is set to [On], [Center Lock-on AF] is activated by pressing the key. The camera detects the subject positioned in the center of the screen and starts tracking by pressing the center of the control wheel. If you press the key while the subject is being tracked, tracking will be canceled.

#### Note

- You cannot set the [Focus Standard] function to [Left Button], [Right Button] or [Down Button].

---



### Related Topic

- [Custom Key\(Shoot.\)](#)/[Custom Key\(PB\)](#)
- [Focus Area](#)
- [Center Lock-on AF](#)

Digital Still Camera  
DSC-RX10M4

## Adjusting the focus area settings to the camera's orientation (horizontal/vertical) (Sw. V/H AF Area)

You can set whether to switch the [Focus Area] and the position of the focusing frame according to the orientation of the camera (horizontal/vertical). This function is useful when shooting scenes for which you have to change the camera position frequently, such as portraits or sports scenes.

1 MENU →  (Camera Settings1) → [ Sw. V/H AF Area] → desired setting.

### Menu item details

#### Off:

Does not switch the [Focus Area] and the position of the focusing frame according to the orientation of the camera (horizontal/vertical).

#### AF Point Only:

Switches the position of the focusing frame according to the orientation of the camera (horizontal/vertical). The [Focus Area] is fixed.

#### AF Point + AF Area:

Switches both the [Focus Area] and the position of the focusing frame according to the orientation of the camera (horizontal/vertical).



### An example when [AF Point + AF Area] is selected



- (A) Vertical: [Flexible Spot] (Upper left corner)  
 (B) Horizontal:[Flexible Spot] (Upper right corner)  
 (C) Vertical:[Center]

- Three camera orientations are detected: horizontal, vertical with the side of the shutter button facing up, and vertical with the side of the shutter button facing down.

### Note

- If the setting for [ Sw. V/H AF Area] is changed, the focus settings for each camera orientation will not be retained.
- The [Focus Area] and the position of the focusing frame will not change even when [ Sw. V/H AF Area] is set to [AF Point + AF Area] or [AF Point Only] in the following situations:
  - When the shooting mode is set to [Intelligent Auto], [Superior Auto], [Movie], or [High Frame Rate]
  - While the shutter button is pressed halfway down
  - During movie shooting
  - While using the digital zoom function
  - While the auto-focusing is activated
  - During continuous shooting
  - During the countdown for the self-timer
  - When [Focus Magnifier] is activated

- When you shoot images right after the power is turned on and the camera is vertical, the first shot is taken with the horizontal focus setting or with the last focus setting.
- The orientation of the camera cannot be detected when the lens is facing up or down.

---

---

### Related Topic

- [Focus Area](#)

4-725-901-11(2) Copyright 2017 Sony Corporation

Digital Still Camera  
DSC-RX10M4

## AF/MF control

---

You can easily switch the focusing mode from auto to manual and vice versa while shooting without changing your holding position.

- 1 MENU →  2 (Camera Settings2) → [Custom Key(Shoot.)] → desired button → [AF/MF Control Hold] or [AF/MF Ctrl Toggle].

### Menu item details

#### AF/MF Control Hold :

Switches the focusing mode while the button is held down.

#### AF/MF Ctrl Toggle :

Switches the focusing mode until the button is pressed again.

#### Note

- You cannot set the [AF/MF Control Hold] function to [Left Button], [Right Button] or [Down Button] of the control wheel.

---

### Related Topic



- [Custom Key\(Shoot.\)/Custom Key\(PB\)](#)

Digital Still Camera  
DSC-RX10M4

## AF w/ shutter (still image)

---

Selects whether to focus automatically when you press the shutter button halfway down. Select [Off] to adjust the focus and the exposure separately.

1 MENU →  (Camera Settings1) → [ AF w/ shutter] → desired setting.

### Menu item details

**On:**

The auto focus operates when you press the shutter button halfway down.

**Off:**

The auto focus does not operate even if you press the shutter button halfway down.

---

### Related Topic

- [AF On](#)
- [Pre-AF \(still image\)](#)
- [Focus Magnifier](#)



Digital Still Camera  
DSC-RX10M4

## AF On

You can focus without pressing the shutter button halfway down. The settings for the focus mode dial will be applied.

- 1 MENU →  2 (Camera Settings2) → [Custom Key(Shoot.)] → desired key, then assign the [AF On] function to the key.
- 2 Press the key to which you have assigned the [AF On] function while auto-focus shooting.

### Hint

- Set [ AF w/ shutter] to [Off] when you do not want to perform auto focusing using the shutter button.
- Set [ AF w/ shutter] and [ Pre-AF] to [Off] to focus at a specific shooting distance predicting the position of the subject.

### Related Topic

- [Custom Key\(Shoot.\)/Custom Key\(PB\)](#)
- [AF w/ shutter \(still image\)](#)
- [Pre-AF \(still image\)](#)



## Eye AF

The camera focuses on the subject's eyes while you keep the button pressed.

- 1 **MENU** →  **2 (Camera Settings2)** → **[Custom Key(Shoot.)]** → **desired key**, then assign the **[Eye AF]** function to the key.
- 2 **Point the camera at a person's face, and press the button to which you have assigned the [Eye AF] function.**
- 3 **Press the shutter button while pressing the button.**

### Hint

- When the camera focuses on the eyes, a detection frame is displayed over the eyes. If the focus mode is set to [Single-shot AF], the frame will disappear after a period of time.

### Note

- If the camera cannot detect a person's face, you cannot use [Eye AF].
- Depending on the circumstances, you cannot use [Eye AF] such as when [Focus Mode] is set to [Manual Focus].
- The [Eye AF] function may not function very well in the following situations:
  - When the person is wearing sunglasses.
  - When the front hair covers the person's eyes.
  - In low-light or back-lit conditions.
  - When the eyes are closed.
  - When the person is in the shade.
  - When the person is out of focus.
  - When the person is moving too much.
- If the person is moving too much, the detection frame may not display correctly over their eyes.
- When the mode dial is set to  (Movie) or **HFR**, or during movie recording, [Eye AF] is unavailable.

### Related Topic

- [Custom Key\(Shoot.\)](#)/[Custom Key\(PB\)](#)
- [Smile/Face Detect.](#)

Digital Still Camera  
DSC-RX10M4

## Center Lock-on AF

When you press the center of the control wheel, the camera detects the subject positioned in the center of the screen and continues to track the subject.

1 MENU →  (Camera Settings1) → [Center Lock-on AF] → [On].

2 Align the target frame (A) over the subject and press the center of the control wheel.

- Press the center again to stop tracking.

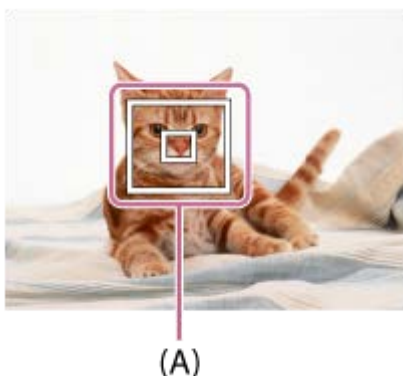



3 Press the shutter button fully down to shoot the image.

### Hint

- If you assign the [Focus Standard] function to the key of your choice, you can activate [Center Lock-on AF] or detect a subject again by pressing the key when [Focus Area] is set to [Wide] or [Center].
- You can select the subject to be tracked by touch operation when shooting using the monitor. Set [Touch Operation] to other than [Off].

### Note

- The [Center Lock-on AF] function may not function very well in the following situations:
  - The subject is moving too quickly.
  - The subject is too small, or too large.
  - The contrast between the subject and the background is poor.
  - It is dark.
  - The ambient light changes.
- Lock-on AF does not work in the following situations:
  - [Sweep Panorama]
  - When [Scene Selection] is set to [Hand-held Twilight] or [Anti Motion Blur].
  - When [Smart Telecon.] is being used.
  - When shooting in Manual Focus mode.
  - When using the digital zoom
  - When the shooting mode is set to Movie, and [ SteadyShot] is set to [Intelligent Active].
  - When shooting movies with [ Record Setting] set to [120p]/[100p]
  - During High Frame Rate shooting

---

---

## Related Topic

- [Focus Standard](#)

4-725-901-11(2) Copyright 2017 Sony Corporation

Digital Still Camera  
DSC-RX10M4

## Focus Hold

---

Locks the focus while the key to which the Focus Hold function has been assigned is pressed.

- 1 MENU →  2 (Camera Settings2) → [Custom Key(Shoot.)] → assign the [Focus Hold] function to the key of your choice.
  - 2 Focus and press the key to which the [Focus Hold] function has been assigned.
  - 3 Press the shutter button while holding down the key.
- 

### Related Topic

- [Custom Key\(Shoot.\)/Custom Key\(PB\)](#)

## Registering the current focus area (AF Area Regist.)

You can move the focusing frame to a preassigned position temporarily using a custom key. This function is useful when shooting scenes in which the subject's movements are predictable; for example, sports scenes. With this function, you can switch the focus area quickly according to the situation.

### How to register focus area

1. MENU →  1 (Camera Settings1) → [ AF Area Regist.] → [On].
2. Set the focus area to the desired position and then hold down the Fn (Function) button.



### How to call up the registered focus area

1. MENU →  2 (Camera Settings2) → [Custom Key(Shoot.)] → desired key, then select [Regist. AF Area hold].
2. Set the camera to the shooting mode, hold down the key to which [Regist. AF Area hold] has been assigned and then press the shutter button to shoot images.

#### Hint

- When a focusing frame is registered using [ AF Area Regist.], the registered focusing frame flashes on the monitor.
- If you assign [Regist AF Area toggle] to a custom key, you can use the registered focusing frame without holding down the key.
- If [Reg. AF Area+AF On] is assigned to a custom key, auto focusing using the registered focusing frame is performed when the key is pressed.

#### Note

- A focus area cannot be registered in the following situations:
  - The mode dial is set to either (Movie) or **HFR**
  - While [Touch Focus] is being performed
  - While using the digital zoom function
  - While [Lock-on AF] is being performed
  - While focusing
  - While performing focus lock
- You cannot assign [Regist. AF Area hold] to [Left Button], [Right Button], or [Down Button].
- You cannot call up the registered focus area in the following situations:
  - The mode dial is set to either **AUTO** (Auto Mode),  (Movie) or **HFR**
- When [ AF Area Regist.] is set to [On], the [Dial / Wheel Lock] setting is locked to [Unlock].

### Related Topic

- [Focus Area](#)
- [Custom Key\(Shoot.\)/Custom Key\(PB\)](#)

Digital Still Camera  
DSC-RX10M4

## Deleting a registered AF Area (Del. Reg. AF Area)

---

Deletes the focusing frame position that was registered using [ AF Area Regist.].

① MENU →  (Camera Settings1) → [ Del. Reg. AF Area].

---

### Related Topic

- [Registering the current focus area \(AF Area Regist.\)](#)

Digital Still Camera  
DSC-RX10M4

## Pre-AF (still image)

---

The product automatically adjusts focus before you press the shutter button halfway down.

**1** MENU →  (Camera Settings1) → [ Pre-AF] → **desired setting.**

### Menu item details

**On:**

Adjusts focus before you press the shutter button halfway down.



**Off:**

Does not adjust focus before you press the shutter button halfway down.

Digital Still Camera  
DSC-RX10M4

## AF Illuminator (still image)

The AF illuminator supplies fill light to focus more easily on a subject in dark surroundings. In the time between pressing the shutter button halfway down and locking the focus, the red AF illuminator lights up to allow the camera to focus easily.

1 MENU →  1 (Camera Settings1) → [ AF Illuminator] → desired setting.

### Menu item details



#### Auto:

The AF illuminator lights up automatically in dark surroundings.

#### Off:

Does not use the AF illuminator.

#### Note

- You cannot use [ AF Illuminator] in the following situations:
  - In movie mode
  - Sweep Panorama
  - When [Focus Mode] is set to [Continuous AF] or [Automatic AF] and the subject is moving (when the focus indicator  or  lights up).
  - When [Focus Magnifier] is activated.
  - When [Scene Selection] is set to the following modes:
    - [Landscape]
    - [Sports Action]
    - [Night Scene]
- If the Multi Interface Shoe is equipped with a flash with an AF illuminator function, when the flash is turned on, the AF illuminator will turn on as well.
- The AF illuminator emits a very bright light. Although there is no health hazard, do not look directly into the AF illuminator at close range.



Digital Still Camera  
DSC-RX10M4

## AF Area Auto Clear

---

Sets whether the focus area should be displayed all the time or should disappear automatically shortly after focus is achieved.

**1** MENU →  1 (Camera Settings1) → [AF Area Auto Clear] → desired setting.

### Menu item details

**On:**

The focus area disappears automatically shortly after focus is achieved.

**Off:**

The focus area is displayed all the time.

Digital Still Camera  
DSC-RX10M4

## Disp. cont. AF area

---

You can set whether or not to display the area that is in focus when [Focus Area] is set to [Wide], in [Continuous AF] mode.

1 MENU →  (Camera Settings1) → [Disp. cont. AF area] → desired setting.

### Menu item details

**On:**

Displays the focus area that is in focus.

**Off:**

Does not display the focus area that is in focus.

**Note**

- When [Focus Area] is set to one of the following, the focusing frames in the area that is in focus turn green:
  - [Center]
  - [Flexible Spot]
  - [Expand Flexible Spot]

Digital Still Camera  
DSC-RX10M4

## Phase Detect. Area

---

Sets whether or not to display the Phase Detection AF area.

1 MENU →  1 (Camera Settings1) → [Phase Detect. Area] → desired setting.

### Menu item details



#### On:

Displays the Phase Detection AF area.

#### Off:

Does not display the Phase Detection AF area.

#### Note

- When the F-value is larger than F8, Phase Detection AF cannot be used. Only Contrast AF is available.
- When [ File Format] is set to [XAVC S HD] and [ Record Setting] is set to [120p]/[100p], Phase Detection AF cannot be used. Only Contrast AF is available.
- When recording movies, the Phase Detection AF area will not be displayed.

## Manual Focus

When it is difficult to focus properly in the autofocus mode, you can adjust the focus manually.

- 1 Turn the focus mode dial (A) to select MF.

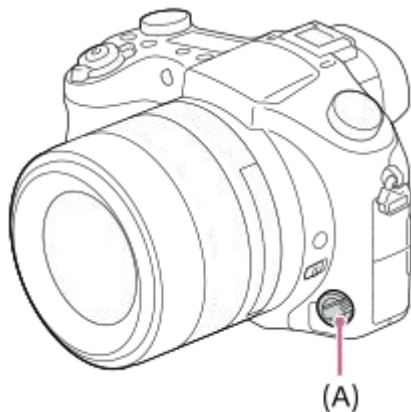

- 2 Rotate the front lens ring to achieve sharp focus.



- When you rotate the front lens ring, the focus distance is displayed on the screen.

- 3 Press the shutter button fully down to shoot an image.

### Hint

- You can assign the focus function to the rear lens ring by selecting MENU →  2 (Camera Settings2) → [Lens Ring Setup].

### Note

- When you use the viewfinder, adjust the diopter level to obtain the correct focus on the viewfinder.
- If you re-select the [Focus Mode], any focus distance that you set manually will be canceled.

### Related Topic

- [Focus Magnifier](#)

- Peaking Level
- MF Assist (still image)
- Lens Ring Setup

4-725-901-11(2) Copyright 2017 Sony Corporation

## Direct manual focus (DMF)

You can make fine adjustments manually after performing auto focusing, letting you focus on a subject more quickly than when using the manual focus from the beginning. This is convenient in situations such as macro shooting.

- 1 Turn the focus mode dial (A) and select DMF.

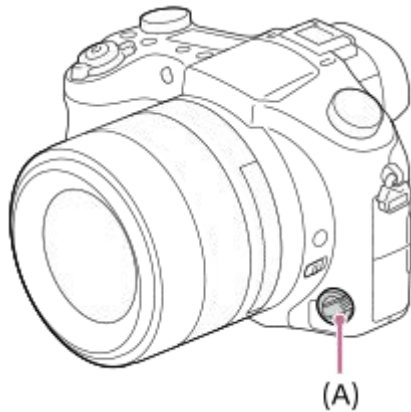

- 2 Press the shutter button halfway down to focus automatically.

- 3 Keep the shutter button pressed halfway down, and then rotate the front lens ring to achieve a sharper focus.



- When you rotate the front lens ring, the focus distance is displayed on the screen.

- 4 Press the shutter button fully down to shoot an image.

### Hint

- You can assign the focus function to the rear lens ring by selecting MENU →  2 (Camera Settings2) → [Lens Ring Setup].

### Related Topic





- [Peaking Level](#)



## Focus Magnifier

You can check the focus by enlarging the image before shooting.

Unlike with [ MF Assist], you can magnify the image without operating the lens ring.

- 1 **MENU** →  (Camera Settings1) → [**Focus Magnifier**].
- 2 **Press the center of the control wheel to enlarge the image and select the area you want to enlarge using top/bottom/left/right side of the control wheel.**
  - Each time you press the center, the magnification scale will change.
  - You can set the initial magnification by selecting MENU →  (Camera Settings1) → [ Initial Focus Mag.].
- 3 **Confirm the focus.**
  - Press the  (Delete) button to bring the magnified position into the center of an image.
  - When the focus mode is [Manual Focus], you can adjust the focus while an image is magnified. The [Focus Magnifier] function will be canceled when the shutter button is pressed halfway.
  - You can set how long the image is to be shown magnified by selecting MENU →  (Camera Settings1) → [Focus Magnif. Time].
- 4 **Press the shutter button fully down to shoot the image.**

### To use the focus magnifier function by touch operation

You can magnify the image and adjust the focus by touching the monitor. Set [Touch Operation] to other than [Off] beforehand. When the focus mode is [Manual Focus], you can perform [Focus Magnifier] by double-tapping the area to focus on while shooting with the monitor.

While shooting with the viewfinder, a frame is displayed in the center of the monitor by double-tapping and you can move the frame by dragging it. The image is magnified by pressing the center of the control wheel.

#### Hint

- While using the focus magnifier function, you can move the magnified area by dragging it on the touch panel.
- To exit the focus magnifier function, double-tap the monitor again. You can also exit the focus magnifier function by pressing the shutter button halfway down.

#### Related Topic

- [MF Assist \(still image\)](#)
- [Focus Magnif. Time](#)
- [Initial Focus Mag. \(still image\)](#)
- [Custom Key\(Shoot.\)/Custom Key\(PB\)](#)
- [Touch Operation](#)





Digital Still Camera  
DSC-RX10M4

## MF Assist (still image)

Enlarges the image on the screen automatically to make manual focusing easier. This works in Manual Focus or Direct Manual Focus shooting.

- 1 MENU →  1 (Camera Settings1) → [ MF Assist] → [On].
- 2 Turn the lens ring to which the focus function has been assigned to adjust the focus.
  - The image is enlarged. You can magnify images further by pressing the center of the control wheel.

### Hint

- You can set how long the image is to be shown magnified by selecting MENU →  1 (Camera Settings1) → [Focus Magnif. Time].

### Note

- You cannot use [ MF Assist] when shooting movies. Use the [Focus Magnifier] function instead.

### Related Topic

- [Manual Focus](#)
- [Direct manual focus \(DMF\)](#)
- [Focus Magnif. Time](#)

Digital Still Camera  
DSC-RX10M4

## Focus Magnif. Time

---

Set the duration for which an image is to be magnified using the [ MF Assist] or [Focus Magnifier] function.

**1** MENU →  1 (Camera Settings1) → [Focus Magnif. Time] → desired setting.

### Menu item details

**2 Sec:**

Magnifies the images for 2 seconds.

**5 Sec:**

Magnifies the images for 5 seconds.

**No Limit:**

Magnifies the images until you press the shutter button.

---

### Related Topic



- [Focus Magnifier](#)
- [MF Assist \(still image\)](#)

Digital Still Camera  
DSC-RX10M4

## Initial Focus Mag. (still image)

---

Sets the initial magnification scale when using [Focus Magnifier]. Select a setting that will help you frame your shot.

**1** MENU →  1 (Camera Settings1) → [ Initial Focus Mag.] → **desired setting.**

### Menu item details

**x1.0:**

Displays the image with the same magnification as the shooting screen.

**x5.3:**

Displays a 5.3-times enlarged image.

---

### Related Topic

- [Focus Magnifier](#)

## Peaking Level

---

Enhances the outline of in-focus ranges using a specific color in Manual Focus or Direct Manual Focus shooting.

**1** MENU →  (Camera Settings1) → [Peaking Level] → desired setting.

### Menu item details

**High:**

Sets the peaking level to high.

**Mid:**

Sets the peaking level to middle.

**Low:**

Sets the peaking level to low.

**Off:**

Does not use the peaking function.

**Note**

- Since the product recognizes sharp areas as in focus, the effect of peaking differs, depending on the subject.
- The outline of in-focus ranges is not enhanced on devices connected via HDMI.

---

### Related Topic

- [Manual Focus](#)
- [Direct manual focus \(DMF\)](#)
- [Peaking Color](#)

Digital Still Camera  
DSC-RX10M4

## Peaking Color

---

Sets the color used for the peaking function in Manual Focus or Direct Manual Focus shooting.

**1** MENU →  1 (Camera Settings1) → [Peaking Color] → desired setting.

### Menu item details

**Red:**

Enhances outlines in red.

**Yellow:**

Enhances outlines in yellow.

**White:**

Enhances outlines in white.

---

### Related Topic

- [Manual Focus](#)
- [Direct manual focus \(DMF\)](#)
- [Peaking Level](#)

Digital Still Camera  
DSC-RX10M4

## Focus Ring Rotate

---

Assigns longer-distance and shorter-distance focus to the rotational directions of the lens ring to which the focus function has been assigned.

1 MENU →  (Camera Settings1) → [Focus Ring Rotate] → desired setting.

### Menu item details

Left  /Right  :

Assigns longer-distance focus to counterclockwise rotation and shorter-distance focus to clockwise rotation.

Right  /Left  :

Assigns longer-distance focus to clockwise rotation and shorter-distance focus to counterclockwise rotation.

---

### Related Topic

- [Lens Ring Setup](#)

Digital Still Camera  
DSC-RX10M4

## Drive Mode

Select the appropriate mode for the subject, such as single shooting, continuous shooting or bracketing shooting.

1 MENU →  (Camera Settings1) → [Drive Mode] → desired setting.

2 Select the desired mode using the right/left side of the control wheel.

### Menu item details

#### Single Shooting:

Normal shooting mode.

#### Cont. Shooting:

Shoots images continuously while you press and hold down the shutter button.

#### Self-timer:

Shoots an image using the self-timer after a designated number of seconds have elapsed since the shutter button was pressed.

#### Self-timer(Cont):

Shoots a designated number of images using the self-timer after a designated number of seconds have elapsed since the shutter button was pressed.

#### BRK C Cont. Bracket:

Shoots images while holding the shutter button down, each with different degrees of exposure.

#### BRK S Single Bracket:

Shoots a specified number of images, one by one, each with a different degrees of exposure.

#### BRK WB WB bracket:

Shoots a total of three images, each with different color tones according to the selected settings for white balance, color temperature and color filter.

#### BRK DRO DRO Bracket:

Shoots a total of three images, each at a different degree of D-Range Optimizer.

#### Note

- When the shooting mode is set to [Scene Selection] and [Sports Action] is selected, [Single Shooting] cannot be performed.

### Related Topic

- [Cont. Shooting](#)
- [Self-timer](#)
- [Self-timer\(Cont\)](#)
- [Cont. Bracket](#)
- [Single Bracket](#)
- [WB bracket](#)
- [DRO Bracket](#)





## Cont. Shooting

Shoots images continuously while you press and hold down the shutter button.

- 1 MENU →  1 (Camera Settings1) → [Drive Mode] → [Cont. Shooting].
- 2 Select the desired mode using the right/left side of the control wheel.

### Menu item details

 Continuous Shooting: Hi /  Continuous Shooting: Mid /  Continuous Shooting: Lo

	 Shutter Type	
	Mechanical Shut.	Auto/Electronic Shut.
Continuous Shooting: Hi	–	24 images per second at maximum*
Continuous Shooting: Mid	10 images per second at maximum*	10 images per second at maximum*
Continuous Shooting: Lo	3.5 images per second at maximum	3.5 images per second at maximum

\* When the F-value is greater than F8, the focus is locked to the setting in the first shot.

#### Hint

- To continuously adjust the focus and exposure during continuous shooting, set as follows:
  - [Focus Mode]: [Continuous AF]
  - [ AEL w/ shutter]: [Off] or [Auto]

#### Note

- Continuous shooting is unavailable in the following situations:
  - The shooting mode is set to [Sweep Panorama].
  - The shooting mode is set to [Scene Selection] and a scene other than [Sports Action] is selected.
  - [Picture Effect] is set to one of the following: [Soft Focus] [HDR Painting] [Rich-tone Mono.] [Miniature] [Watercolor] [Illustration]
  - [DRO/Auto HDR] is set to [Auto HDR].
  - [ISO] is set to [Multi Frame NR].
  - [Smile Shutter] is being used.
- When [ Shutter Type] is set to [Mechanical Shut.], the continuous shooting speed cannot be set to [Continuous Shooting: Hi].

### Related Topic

- [Focus Mode](#)
- [AEL w/ shutter \(still image\)](#)
- [Shutter Type \(still image\)](#)



Digital Still Camera  
DSC-RX10M4

## Self-timer

Shoots an image using the self-timer after a designated number of seconds have elapsed since the shutter button was pressed. Use the 5-second/10-second self-timer when you are going to be in the picture, and use the 2-second self-timer to reduce camera-shake caused by pressing the shutter button.

1 MENU →  1 (Camera Settings1) → [Drive Mode] → [Self-timer].

2 Select the desired mode using the right/left side of the control wheel.

3 Adjust the focus and shoot the image.

The self-timer lamp flashes, a beep sounds, and a picture is taken after the designated number of seconds have elapsed.

### Menu item details



The mode determines the number of seconds until a picture is taken after the shutter button is pressed.

 10 Self-timer: 10 Sec

 5 Self-timer: 5 Sec

 2 Self-timer: 2 Sec

#### Hint

- Press the shutter button again to stop the count of the self-timer.
- Select MENU →  1 (Camera Settings1) → [Drive Mode] → [Single Shooting] to cancel the self-timer.
- Set [Audio signals] to [Off] to mute the beep sound during self-timer counting.
- To use the self-timer in bracket mode, select bracket mode under drive mode, then select MENU →  1 (Camera Settings1) → [Bracket Settings] → [Selftimer during Brkt].

#### Note

- The self-timer is unavailable in the following situations:
  - The shooting mode is set to [Sweep Panorama].
  - [Sports Action] under [Scene Selection]
  - [Smile Shutter]

### Related Topic

- [Audio signals](#)

## Self-timer(Cont)

Shoots a designated number of images using the self-timer after a designated number of seconds have elapsed since the shutter button was pressed. You can choose the best from multiple shots.

1 MENU →  1 (Camera Settings1) → [Drive Mode] → [Self-timer(Cont)].

2 Select the desired mode using the right/left side of the control wheel.

3 Adjust the focus and shoot the image.

The self-timer lamp flashes, a beep sounds, and pictures are taken after the designated number of seconds has elapsed. The designated number of pictures are taken continuously.

### Menu item details

For example, three images are shot when 10 seconds have elapsed after the shutter button is pressed when [Self-timer(Cont.): 10 Sec. 3 Img.] is selected.

 Self-timer(Cont.): 10 Sec. 3 Img.

 Self-timer(Cont.): 10 Sec. 5 Img.

 Self-timer(Cont.): 5 Sec. 3 Img.

 Self-timer(Cont.): 5 Sec. 5 Img.

 Self-timer(Cont.): 2 Sec. 3 Img.

 Self-timer(Cont.): 2 Sec. 5 Img.

#### Hint

- Press the shutter button again to stop the count of the self-timer.
- Select MENU →  1 (Camera Settings1) → [Drive Mode] → [Single Shooting] to cancel the self-timer.

Digital Still Camera  
DSC-RX10M4

## Cont. Bracket

Shoots multiple images while automatically shifting the exposure from base to darker and then to lighter. You can select an image that suits your purpose after recording.

- 1 MENU →  (Camera Settings1) → [Drive Mode] → [Cont. Bracket].
- 2 Select the desired mode using the right/left side of the control wheel.
- 3 Adjust the focus and shoot the image.
  - The base exposure is set at the first shot.
  - Keep pressing and holding the shutter button until bracket shooting is finished.

### Menu item details

For example, the camera shoots a total of three images continuously with an exposure value shifted by plus or minus 0.3 EV when [Cont. Bracket: 0.3EV 3 Image] is selected.

#### Note

- The last shot is shown on the auto review.
- When [ISO AUTO] is selected in [Manual Exposure] mode, the exposure is changed by adjusting the ISO value. If a setting other than [ISO AUTO] is selected, the exposure is changed by adjusting the shutter speed.
- When the exposure is compensated, the exposure is shifted based on the compensated value.
- Bracket shooting is unavailable in the following shooting modes:
  - [Intelligent Auto]
  - [Superior Auto]
  - [Scene Selection]
  - [Sweep Panorama]
- When the flash is used, the product performs flash bracket shooting, which shifts the amount of flash light even if [Cont. Bracket] is selected. Press the shutter button for each image.

### Related Topic

- [Bracket Settings](#)
- [Indicator during bracket shooting](#)

Digital Still Camera  
DSC-RX10M4

## Single Bracket

Shoots multiple images while automatically shifting the exposure from base to darker and then to lighter. You can select the image that suits your purpose after recording.

Since a single picture is taken each time you press the shutter button, you can adjust the focus or the composition for each shot.

- 1 MENU →  1 (Camera Settings1) → [Drive Mode] → [Single Bracket].
- 2 Select the desired mode using the right/left side of the control wheel.
- 3 Adjust the focus and shoot the image.
  - Press the shutter button for each image.

### Menu item details

For example, when [Single Bracket: 0.3EV 3 Image] is selected, three images are shot one at a time with the exposure value shifted up and down in increments of 0.3 EV.

#### Note

- When [ISO AUTO] is selected in [Manual Exposure] mode, the exposure is changed by adjusting the ISO value. If a setting other than [ISO AUTO] is selected, the exposure is changed by adjusting the shutter speed.
- When the exposure is compensated, the exposure is shifted based on the compensated value.
- Bracket shooting is unavailable in the following shooting modes:
  - [Intelligent Auto]
  - [Superior Auto]
  - [Scene Selection]
  - [Sweep Panorama]

### Related Topic

- [Bracket Settings](#)
- [Indicator during bracket shooting](#)

## Indicator during bracket shooting

### Viewfinder

Ambient light\* bracketing

3 images shifted by 0.3 EV steps

Exposure compensation  $\pm 0.0$  EV

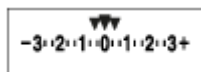

### Monitor (Display All Info. or Histogram)

Ambient light\* bracketing

3 images shifted by 0.3 EV steps

Exposure compensation  $\pm 0.0$  EV



Flash bracketing

3 images shifted by 0.7 EV steps

Flash compensation -1.0 EV

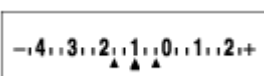

### Monitor (For viewfinder)

Ambient light\* bracketing (upper indicator)

3 images shifted by 0.3 EV steps

Exposure compensation  $\pm 0.0$  EV

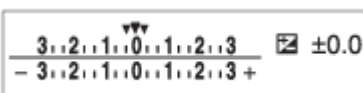

Flash bracketing (lower indicator)

3 images shifted by 0.7 EV steps

Flash compensation -1.0 EV

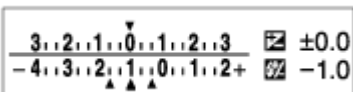

\* Ambient light: A generic term for non-flash light including natural light, electric bulb and fluorescent lighting. Whereas the flash light blinks for a moment, ambient light is constant, so this kind of light is called "ambient light."

### Note

- During bracket shooting, guides equal to the number of images to be shot are displayed over/under the bracket indicator.
- When you start single bracket shooting, the guides will disappear one by one as the camera records images.





Digital Still Camera  
DSC-RX10M4

## WB bracket

---

Shoots a total of three images, each with different color tones according to the selected settings for white balance, color temperature and color filter.

- 1 MENU →  1 (Camera Settings1) → [Drive Mode] → [WB bracket].
- 2 Select the desired mode using the right/left side of the control wheel.
- 3 Adjust the focus and shoot the image.

### Menu item details

#### White Balance Bracket: Lo:

Records a series of three images with small changes in the white balance (within the range of 10MK<sup>-1</sup>\*).

#### White Balance Bracket: Hi:

Records a series of three images with large changes in the white balance (within the range of 20MK<sup>-1</sup>\*).

\* MK<sup>-1</sup> is the unit that indicates the capability of color temperature conversion filters and indicates the same value as "mired."

#### Note

- The last shot is shown on the auto review.

---

### Related Topic

- [Bracket Settings](#)

Digital Still Camera  
DSC-RX10M4

## DRO Bracket

---

You can record a total of three images, each at a different degree of D-Range Optimizer value.

- 1 MENU →  1 (Camera Settings1) → [Drive Mode] → [DRO Bracket].
- 2 Select the desired mode using the right/left side of the control wheel.
- 3 Adjust the focus and shoot the image.

### Menu item details

#### DRO Bracket: Lo:

Records a series of three images with small changes in the D-Range Optimizer value (Lv 1, Lv 2, and Lv 3).

#### DRO Bracket: Hi:

Records a series of three images with large changes in the D-Range Optimizer value (Lv 1, Lv 3, and Lv 5).

#### Note

- The last shot is shown on the auto review.

---

### Related Topic

- [Bracket Settings](#)

Digital Still Camera  
DSC-RX10M4

## Bracket Settings

---

You can set the self-timer in bracket shooting mode, and the shooting order for exposure bracketing and white balance bracketing.

1 MENU →  1 (Camera Settings1) → [Drive Mode] → select bracket shooting mode.

2 MENU →  1 (Camera Settings1) → [Bracket Settings] → desired setting.

### Menu item details

#### Selftimer during Brkt:

Sets whether to use the self-timer during bracket shooting. Also sets the number of seconds until the shutter is released if using the self-timer.

(OFF/2 Sec/5 Sec/10 Sec)

#### Bracket order:

Sets the order of exposure bracketing and white balance bracketing.

(0→-→+/-→0→+)

---

### Related Topic

- [Cont. Bracket](#)
- [Single Bracket](#)
- [WB bracket](#)
- [DRO Bracket](#)

Digital Still Camera  
DSC-RX10M4

## Touch Operation

---

Sets whether or not to activate touch operations on the monitor.

Touch operations when shooting with the monitor are referred to as "touch panel operations," and touch operations when shooting with the viewfinder are referred to as "touch pad operations."

1 MENU →  (Setup) → [Touch Operation] → desired setting.

### Menu item details

**Touch Panel+Pad:**

Activates both the touch panel operations when shooting with the monitor and touch pad operations when shooting with the viewfinder.

**Touch Panel Only:**

Activates only the touch panel operations when shooting with the monitor.

**Touch Pad Only:**

Activates only the touch pad operations when shooting with the viewfinder.

**Off:**

Deactivates all touch operations.

---

### Related Topic

- [Touch Focus](#)
- [Touch Pad Settings](#)

## Touch Focus

You can select a subject on which to focus using touch operations in the still image and movie recording modes.

- 1 MENU →  (Setup) → [Touch Operation] → Desired setting other than [Off].

### Specifying the position where you want to focus in the still image mode

You can focus on the desired position by touching the monitor.

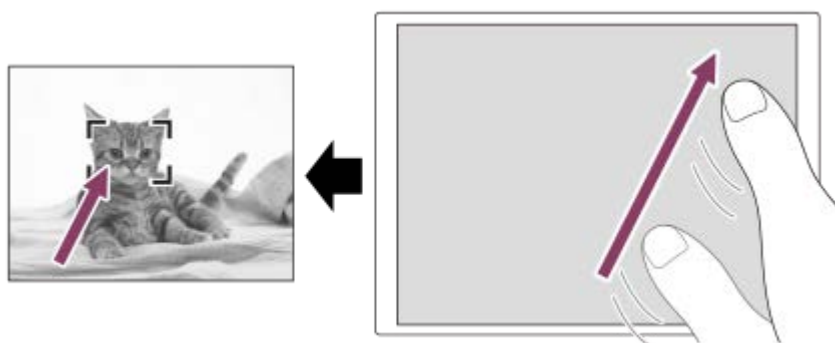

1. Select a [Focus Area] other than [Flexible Spot] or [Expand Flexible Spot].
2. MENU →  1 (Camera Settings1) → [Center Lock-on AF] → [Off].
3. Touch the monitor.
  - When shooting with the monitor, touch the subject to focus.
  - When shooting with the viewfinder, you can move the position of the focus by touching and dragging on the monitor while looking through the viewfinder.



- When the shutter button is pressed halfway down, the camera focuses on the focusing frame. Press the shutter button all the way down to shoot images.
- To cancel focusing with touch operations, touch  or press the center of the control wheel if shooting with the monitor, and press the center of the control wheel if shooting with the viewfinder.

### Specifying the position where you want to focus in the movie recording mode (spot focus)

The camera will focus on the touched subject. Spot focus is not available when shooting with the viewfinder.

1. Select a [Focus Area] other than [Flexible Spot] or [Expand Flexible Spot].
2. MENU →  1 (Camera Settings1) → [Center Lock-on AF] → [Off].
3. Touch the subject on which you want to focus before or during recording.
  - When you touch the subject, the focus mode temporarily switches to manual focus and the focus can be adjusted using the front lens ring.
  - To cancel spot focus, touch  or press the center of the control wheel.

#### Hint

- In addition to the touch focus function, touch operations such as the following are also available.
  - When [Focus Area] is set to [Flexible Spot] or [Expand Flexible Spot], the focusing frame can be moved using touch operations.
  - When the [Focus Mode] is set to [Manual Focus], the focus magnifier can be used by double-tapping the monitor.

#### Note

- The touch focus function is not available in the following situations:
  - When the shooting mode is set to [Sweep Panorama].
  - When [Focus Mode] is set to [Manual Focus].
  - When using the digital zoom

---

---

### Related Topic

- [Touch Operation](#)

4-725-901-11(2) Copyright 2017 Sony Corporation

## Touch Pad Settings

You can adjust settings related to touch pad operations during viewfinder shooting.

1 MENU →  (Setup) → [Touch Pad Settings] → desired setting.

### Menu item details

#### Operation in V Orient.:

Sets whether to enable touch pad operations during vertically oriented viewfinder shooting. You can prevent erroneous operations during vertically oriented shooting caused by your nose, etc. touching the monitor.

#### Touch Pos. Mode:

Sets whether to move the focusing frame to the position touched on the screen ([Absolute Position]), or move the focusing frame to the desired position based on the direction of dragging and the amount of movement ([Relative Position]).

#### Operation Area:

Sets the area to be used for touch pad operations. Restricting the operational area can prevent erroneous operations caused by your nose, etc. touching the monitor.

### About Touch Positioning Mode

Selecting [Absolute Position] lets you move the focusing frame to a distant position more quickly because you can directly specify the position of the focusing frame with touch operations.

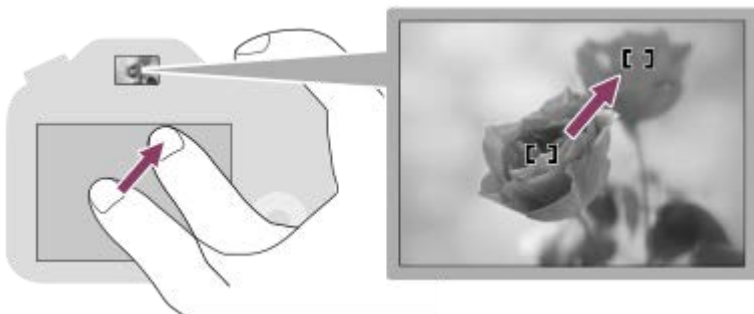

Selecting [Relative Position] lets you operate the touch pad from wherever is easiest, without having to move your finger over a wide area.

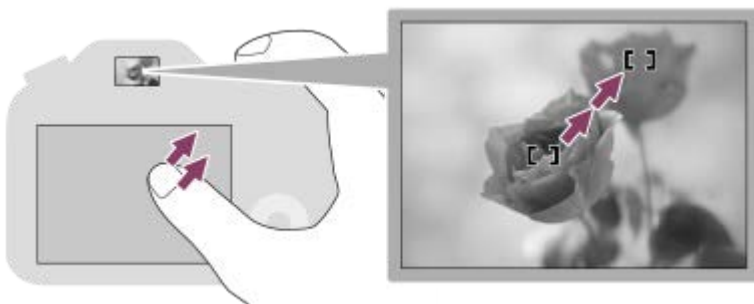

#### Hint

- In touch pad operations when [Touch Pos. Mode] is set to [Absolute Position], the area set in [Operation Area] is treated as the entire screen.

---

---

## Related Topic

- [Touch Operation](#)



4-725-901-11(2) Copyright 2017 Sony Corporation



Digital Still Camera  
DSC-RX10M4

## Image Size (still image)

The larger the image size, the more detail will be reproduced when the image is printed on large-format paper. The smaller the image size, the more images can be recorded.

1 MENU →  (Camera Settings1) → [ Image Size] → desired setting.

### Menu item details

[  Aspect Ratio] is set to [3:2]	
L: 20M	5472×3648 pixels
M: 10M	3888×2592 pixels
S: 5.0M	2736×1824 pixels

[  Aspect Ratio] is set to [4:3]	
L: 18M	4864×3648 pixels
M: 10M	3648×2736 pixels
S: 5.0M	2592×1944 pixels
VGA	640×480 pixels

[  Aspect Ratio] is set to [16:9]	
L: 17M	5472×3080 pixels
M: 7.5M	3648×2056 pixels
S: 4.2M	2720×1528 pixels

[  Aspect Ratio] is set to [1:1]	
L: 13M	3648×3648 pixels
M: 6.5M	2544×2544 pixels
S: 3.7M	1920×1920 pixels

#### Note

- When [ Quality] is set to [RAW] or [RAW & JPEG], the image size for RAW images corresponds to "L."

### Related Topic



- Aspect Ratio (still image)

4-725-901-11(2) Copyright 2017 Sony Corporation

Digital Still Camera  
DSC-RX10M4

## Aspect Ratio (still image)

---

① MENU →  1 (Camera Settings1) → [ Aspect Ratio] → desired setting.

### Menu item details

**3:2:**

Same aspect ratio as 35 mm plate film

**4:3:**

An aspect ratio suitable for viewing on a TV that does not support high definition

**16:9:**

An aspect ratio suitable for viewing on a TV that supports high definition

**1:1:**

The horizontal and vertical ratio is equal.

Digital Still Camera  
DSC-RX10M4

## Quality (still image)

1 MENU →  (Camera Settings1) → [ Quality] → desired setting.

### Menu item details

#### RAW:

File format: RAW (records in the compressed RAW format)

Digital processing is not performed on this file format. Select this format to process images on a computer for professional purposes.

- The image size is fixed to the maximum size. The image size is not displayed on the screen.

#### RAW & JPEG:

File format: RAW (records in the compressed RAW format) + JPEG

A RAW image and a JPEG image are created at the same time. This is suitable when you need 2 image files, a JPEG for viewing, and a RAW for editing. The JPEG image quality is set to [Fine].

#### Extra fine:

File format: JPEG

The image is compressed in the JPEG format and recorded using a higher quality than with [Fine].

#### Fine:

File format: JPEG

The image is compressed in the JPEG format when recorded.

#### Standard:

File format: JPEG

The image is compressed in the JPEG format when recorded. Since the compression rate of [Standard] is higher than that of [Fine], the file size of [Standard] is smaller than that of [Fine]. This will allow more files to be recorded on one memory card, but the image quality will be lower.

### About RAW images

- To open a RAW image file recorded with this camera, the software Image Data Converter is needed. With Image Data Converter, you can open a RAW image file, then convert it into a popular image format such as JPEG or TIFF, or readjust the white balance, saturation or contrast of the image.
- You cannot apply [Auto HDR] or [Picture Effect] functions with RAW images.

#### Note

- If you do not intend to edit the images on your computer, we recommend that you record in JPEG format.
- You cannot add DPOF (print order) registration marks to RAW images.

Digital Still Camera  
DSC-RX10M4

## Panorama: Size

---

Sets the image size when shooting panoramic images. The image size varies depending on the [Panorama: Direction] setting.

1 MENU →  (Camera Settings1) → [Panorama: Size] → desired setting.

### Menu item details

When [Panorama: Direction] is set to [Up] or [Down]

**Standard:** 3872×2160

**Wide:** 5536×2160

When [Panorama: Direction] is set to [Left] or [Right]

**Standard:** 8192×1856

**Wide:** 12416×1856

---

### Related Topic

- [Sweep Panorama](#)
- [Panorama: Direction](#)

Digital Still Camera  
DSC-RX10M4

## Panorama: Direction

---

Sets the direction to pan the camera when shooting panoramic images.

**1** MENU →  1 (Camera Settings1) → [Panorama: Direction] → desired setting.

### Menu item details

**Right:**

Pan the camera from the left to the right.

**Left:**

Pan the camera from the right to the left.

**Up:**

Pan the camera from the bottom to the top.

**Down:**

Pan the camera from the top to the bottom.

---

### Related Topic

- [Sweep Panorama](#)

Digital Still Camera  
DSC-RX10M4

## List of mode dial function

You can switch the shooting mode according to the subject or purpose of shooting.

- 1 Turn the mode dial to select the desired shooting mode.

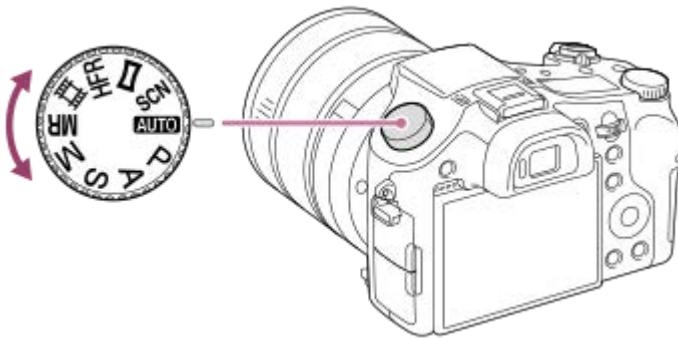

### Available functions

#### **AUTO** (Auto Mode):

Allows you to shoot still images of any subject under any condition with good results by setting the values determined appropriate by the product.

#### **P (Program Auto):**

Allows you to shoot with the exposure adjusted automatically (both the shutter speed and the aperture value (F value)). Also you can select various settings using the menu.

#### **A (Aperture Priority):**

Allows you to adjust the aperture and shoot when you want to blur the background, etc.

#### **S (Shutter Priority):**

Allows you to shoot fast-moving subjects etc., by manually adjusting the shutter speed.

#### **M (Manual Exposure):**

Allows you to shoot still images with the desired exposure by adjusting the exposure (both the shutter speed and the aperture value (F value)).

#### **MR (Memory recall):**

Allows you to shoot an image after recalling often-used modes or numeric settings registered in advance.

#### **Movie:**

Allows you to set an exposure mode and shoot movies.

#### **HFR (High Frame Rate):**

Allows you to shoot movies with a higher frame rate than the recording format so that you can record smooth super-slow-motion movies.

#### **Sweep Panorama:**

Allows you to shoot a panoramic image by compositing the images.

#### **SCN (Scene Selection):**

Allows you to shoot with preset settings according to the scene.

### Related Topic

- [Intelligent Auto](#)
- [Superior Auto](#)
- [Program Auto](#)
- [Aperture Priority](#)

- Shutter Priority
- Manual Exposure
- Recall (Camera Settings1/Camera Settings2)
- Movie: Exposure Mode
- Shooting super-slow-motion movies (HFR Settings)
- HFR (High Frame Rate): Exposure Mode
- Sweep Panorama
- Scene Selection

4-725-901-11(2) Copyright 2017 Sony Corporation



## Intelligent Auto

---

The camera shoots with automatic scene recognition.

- 1 Set the mode dial to **AUTO** (Auto Mode).
- 2 MENU →  (Camera Settings1) → [Auto Mode] → [Intelligent Auto].
- 3 Point the camera at the subject.

When the camera recognized the scene, the icon for the recognized scene appears on the screen.



- 4 Adjust the focus and shoot the image.

### Note

- The product will not recognize the scene when you shoot images with zoom functions other than optical zoom.
- The product may not properly recognize the scene under certain shooting conditions.
- For [Intelligent Auto] mode, most of the functions are set automatically, and you cannot adjust the settings on your own.

---

### Related Topic

- [Switching the auto mode \(Auto Mode\)](#)
- [About Scene Recognition](#)
- [Mode Dial Guide](#)

Digital Still Camera  
DSC-RX10M4

## Superior Auto

The camera shoots with automatic scene recognition. This mode takes clear images of dark or backlit scenes.

For low-lit or backlit scenes, if necessary the camera may shoot multiple images and create a composite image, etc., to record higher quality images than in Intelligent Auto mode.

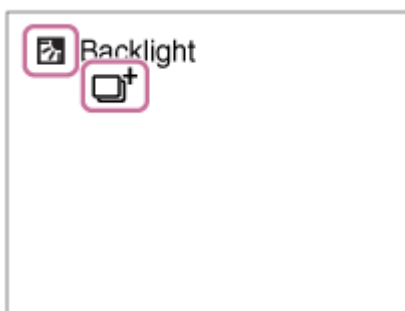

- 1 Set the mode dial to **AUTO** (Auto Mode).
- 2 MENU →  1 (Camera Settings1) → [Auto Mode] → [Superior Auto].
- 3 Point the camera to the subject.

When the camera recognizes a scene, scene recognition icon appears on the screen. If necessary,  (overlay icon) may appear.



- 4 Adjust the focus and shoot the image.

### Note

- When the product is used to create composite images, the recording process takes longer than usual. In this case, the  (overlay icon) is displayed and the shutter sound is heard multiple times, but only one image is recorded.
- When the  (overlay icon) is displayed, be sure not to move the camera before the multiple shots are recorded.
- The product will not recognize the scene when you use zoom functions other than optical zoom.
- The product may not properly recognize a scene under some shooting conditions.
- When [  Quality ] is set to [RAW] or [RAW & JPEG], the product cannot create a composite image.
- For [Superior Auto] mode, most of the functions are set automatically, and you cannot adjust the settings on your own.

### Related Topic

- [Switching the auto mode \(Auto Mode\)](#)
- [Mode Dial Guide](#)
- [About Scene Recognition](#)



Digital Still Camera  
DSC-RX10M4

## Switching the auto mode (Auto Mode)

This camera is equipped with the following two automatic shooting modes: [Intelligent Auto] and [Superior Auto]. You can switch the auto mode to shoot according to the subject and your preferences.

- 1 Set the mode dial to **AUTO**.
- 2 MENU →  1 (Camera Settings1) → [Auto Mode] → desired setting.

### Menu item details



#### Intelligent Auto:

Allows you to shoot with automatic scene recognition.

#### Superior Auto:

Allows you to shoot with automatic scene recognition. This mode takes clear images of dark or backlit scenes.

#### Note

- In [Superior Auto] mode, the recording process takes longer, since the product creates a composite image. In this case, the  (overlay icon) is displayed and the shutter sound is heard multiple times, but only one image is recorded.
- In [Superior Auto] mode and when the  (overlay icon) is displayed, be sure not to move the camera before the multiple shots are recorded.
- For [Intelligent Auto] and [Superior Auto] mode, most of the functions are set automatically, and you cannot adjust the settings on your own.

### Related Topic

- [Intelligent Auto](#)
- [Superior Auto](#)

Digital Still Camera  
DSC-RX10M4

## About Scene Recognition











---

Scene Recognition operates in [Intelligent Auto] mode and [Superior Auto] mode.

This function allows the product to automatically recognize the shooting conditions and shoot the image.



### Scene Recognition

When the product recognizes certain scenes, the following icons and guides are displayed on the first line:

-  (Portrait)
-  (Infant)
-  (Night Portrait)
-  (Night Scene)
-  (Backlight Portrait)
-  (Backlight)
-  (Landscape)
-  (Macro)
-  (Spotlight)
-  (Low Light)

When the product recognizes certain conditions, the following icons are displayed on the second line:

-  (Tripod)
-  (Walk)\*
-  (Move)
-  (Move (Bright))
-  (Move (Dark))

\* The condition  (Walk) is recognized only when [ SteadyShot] is set to [Active] or [Intelligent Active].

#### Note

- When [Smile/Face Detect.] is set to [Off], the [Portrait], [Backlight Portrait], [Night Portrait] and [Infant] scenes are not recognized.

---

#### Related Topic

- [Intelligent Auto](#)
- [Superior Auto](#)

Digital Still Camera  
DSC-RX10M4

## Program Auto

---

Allows you to shoot with the exposure adjusted automatically (both the shutter speed and the aperture value).

You can set shooting functions such as [ISO].

- 1 **Set the mode dial to P (Program Auto).**
- 2 **Set the shooting functions to your desired settings.**
- 3 **Adjust the focus and shoot the subject.**

## Program Shift

When you are not using a flash, you can change the shutter speed and aperture (F-value) combination without changing the appropriate exposure set by the camera.

Turn the control dial to select the aperture value and shutter speed combination.

- "P" on the screen changes to "P\*" when you turn the control dial.
- To cancel program shift, set the shooting mode to other than [Program Auto], or turn off the camera.

### Note

- According to the brightness of the environment, the program shift may not be used.
- Set the shooting mode to another one than "P" or turn off the power to cancel the setting you made.
- When the brightness changes, the aperture (F-value) and shutter speed also change while maintaining the shift amount.

## Aperture Priority

You can shoot by adjusting the aperture and changing the range in focus, or by defocusing the background.

- 1 Set the mode dial to A (Aperture Priority).
- 2 Select the desired value by rotating the aperture ring (A).

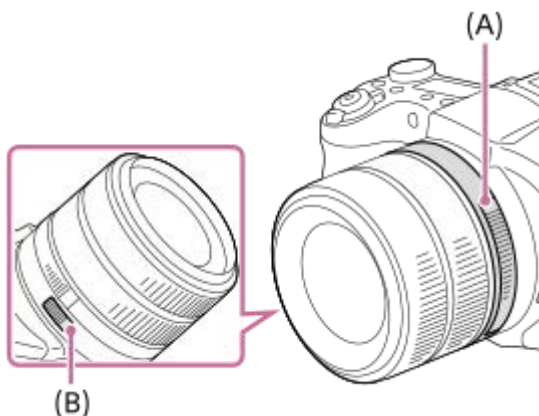

- Smaller F-value: The subject is in focus, but objects in front of and beyond the subject are blurred.  
Larger F-value: The subject and its foreground and background are all in focus.
- If the aperture value you have set is not suitable for appropriate exposure, the shutter speed on the shooting screen will blink. If this happens, change the aperture value.

- 3 Adjust the focus and shoot the subject.

The shutter speed is automatically adjusted to obtain proper exposure.

### About the aperture ring

The maximum aperture depends on the focal length of the lens. You cannot open the aperture wider than the maximum even if you set a smaller F-value using the aperture ring. You can confirm the correct F-value on the display panel of the monitor.

#### Hint

- You can change the click texture of the aperture ring using the Aperture Click Switch (B). When shooting still images, set the Aperture Click Switch to "ON," and for movies, set it to "OFF."

#### Note

- The brightness of the image on the screen may differ from the actual image being shot.
- We recommend that you set the aperture value to between F2.4 and F8 if you want to shoot images with high resolution.

Digital Still Camera  
DSC-RX10M4

## Shutter Priority

You can express the movement of a moving subject in various ways by adjusting the shutter speed, for example, at the instant of the movement with high speed shutter, or as a trailing image with low speed shutter.

**1 Set the mode dial to S (Shutter Priority).**

**2 Select the desired value by turning the control dial.**

- If proper exposure cannot be obtained after setup, the aperture value on the shooting screen blinks. If this happens, change the shutter speed.



**3 Adjust the focus and shoot the subject.**

The aperture is automatically adjusted to obtain proper exposure.

### Hint

- Use a tripod to prevent camera-shake when you have selected a slow shutter speed.
- When you shoot indoor sports scenes, set the ISO sensitivity to a higher value.

### Note

- The SteadyShot warning indicator does not appear in shutter speed priority mode.
- When [ Long Exposure NR] is set to [On] and the shutter speed is 1/3 second(s) or longer with a [ Shutter Type] other than [Electronic Shut.] is set, noise reduction after shooting is performed for the same amount of time that the shutter was open. However, you cannot shoot any more while noise reduction is in progress.
- The brightness of the image on the screen may differ from the actual image being shot.

### Related Topic

- [Long Exposure NR \(still image\)](#)



## Manual Exposure

You can shoot with the desired exposure setting by adjusting both the shutter speed and aperture.

**1 Set the mode dial to M (Manual Exposure).**

**2 Select the desired aperture value by turning the aperture ring.  
Select the desired shutter speed by turning the control dial.**

- You can also set [ISO] to [ISO AUTO] in manual exposure mode. The ISO value automatically changes to achieve the appropriate exposure using the aperture value and shutter speed you have set.
- When [ISO] is set to [ISO AUTO], the ISO value indicator will blink if the value you have set is not suitable for appropriate exposure. If this happens, change the shutter speed or aperture value.
- When [ISO] is set to other than [ISO AUTO], use MM (Metered Manual)\* to check the exposure value.

**Toward +:** Images become brighter.

**Toward -:** Images become darker.

**0:** Appropriate exposure analyzed by the product.

\* Indicates under/over for appropriate exposure. It is displayed using a numerical value on the monitor and with a metering indicator on the viewfinder.

**3 Adjust the focus and shoot the subject.**

### Hint

- You can change the shutter speed and aperture (F-value) combination without changing the set exposure value by rotating the aperture ring while pressing the AEL button. (Manual shift)

### Note

- The Metered Manual indicator does not appear when [ISO] is set to [ISO AUTO].
- When the amount of ambient light exceeds the metering range of the Metered Manual, the Metered Manual indicator flashes.
- The SteadyShot warning indicator does not appear in manual exposure mode.
- The brightness of the image on the screen may differ from the actual image being shot.

Digital Still Camera  
DSC-RX10M4

## Bulb shooting

You can shoot a trailing image of the movement of a subject with long exposure. Bulb shooting is suitable for shooting trails from stars or fireworks, etc.

- 1 **Set the mode dial to M (Manual Exposure).**
- 2 **Turn the control dial clockwise until [BULB] is indicated.**
- 3 **Select the aperture value (F-value) using the aperture ring.**
- 4 **Press the shutter button halfway down to focus.**
- 5 **Press and hold the shutter button for the duration of the shooting.**

As long as the shutter button is pressed, the shutter remains open.

### Hint

- When shooting fireworks, etc., focus at infinity in manual focus mode.
- In order to perform bulb shooting without causing the image quality to deteriorate, we recommend that you start shooting while the camera is cool.
- Images shot in [BULB] mode tend to be blurry. We recommend that you use a tripod and a remote commander (sold separately) that has a shutter button lock function. Use a remote commander supporting connection via multi/micro USB jack.

### Note

- The longer the exposure time, the more noise will be visible on the image.
- After shooting, noise reduction will be done for the same amount of time that the shutter was open. However, you cannot shoot any more while noise reduction is in progress.
- You cannot set the shutter speed to [BULB] in the following situations:
  - [Smile Shutter]
  - [Auto HDR]
  - [Picture Effect] is set to [HDR Painting] or [Rich-tone Mono.].
  - [Multi Frame NR]
  - When [Drive Mode] is set to the following:
    - [Cont. Shooting]
    - [Self-timer(Cont)]
    - [Cont. Bracket]
  - [ Shutter Type] is set to [Electronic Shut.].

If you use the above functions when the shutter speed is set to [BULB], the shutter speed is temporarily set to 30 seconds.

### Related Topic

- [Manual Exposure](#)



Digital Still Camera  
DSC-RX10M4

## Sweep Panorama

Allows you to create a single panoramic image from multiple images shot while panning the camera.



- 1 Set the mode dial to  (Sweep Panorama).
- 2 Point the camera at the subject.
- 3 While pressing the shutter button halfway down, aim the camera at one end of the desired panoramic composition.
  - You can change the shooting direction prior to shooting using the control dial.

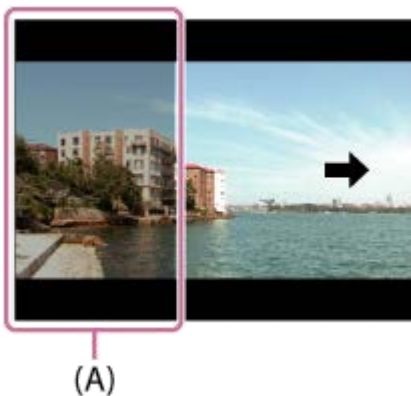

(A) This part will not be shot.



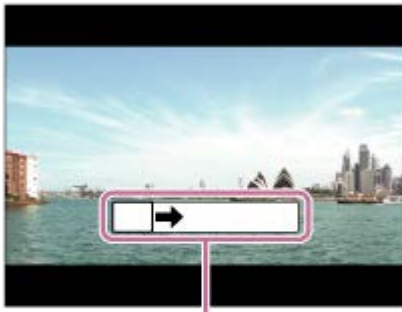

- 4 Press the shutter button fully down.
- 5 Pan the camera to the end of the guide in the direction of the arrow on the monitor.



(B)

(B) Guidance bar

### Note

- If the entire angle of the panoramic shot is not achieved within the set time, a gray area occurs in the composite image. If this happens, move the product faster to record the full panoramic image.
- When [Wide] is selected for [Panorama: Size], the entire angle of the panoramic shot may not be achieved within the given time. If this happens, try shooting after changing [Panorama: Size] to [Standard].
- Since several images are stitched together, the stitched part may not be recorded smoothly in some cases.
- The images may be blurred in dark scenes.
- When a light source such as a fluorescent light flickers, the brightness and color of a stitched image may not be consistent.
- When the whole angle of panoramic shooting and the AE/AF locked angle are very different in brightness and focus, the shooting may not be successful. If this happens, change AE/AF locked angle and shoot again.
- The following situations are not suited for shooting Sweep Panorama:
  - Moving subjects.
  - Subjects that are too close to the product.
  - Subjects with continuously similar patterns, such as the sky, beach, or a lawn.
  - Subjects with constant change such as waves or water falls.
  - Subjects with brightness widely different from its surroundings such as the sun or a light bulb.
- The Sweep Panorama shooting may be interrupted in the following situations:
  - When the camera is panned too fast or too slow.
  - When the camera shakes too much.
- Continuous shooting is performed during shooting Sweep Panorama and the shutter sound keeps beeping until shooting is finished.
- The following functions are not available with Sweep Panorama:
  - Smile/Face Detect.
  -  Auto Obj. Framing
  - DRO/Auto HDR
  - Picture Effect
  - Picture Profile
  -  Soft Skin Effect
  -  Long Exposure NR
  -  High ISO NR
  - Lock-on AF
  - Zoom
  - Drive Mode
  - Bright Monitoring
- The values of the settings for some functions are fixed with Sweep Panorama, as follows:
  - [ISO] is fixed to [ISO AUTO].
  - [Focus Area] is fixed to [Wide].
  - [Flash Mode] is fixed to [Flash Off].

---

---

**Related Topic**

- [Panorama: Size](#)
- [Panorama: Direction](#)

4-725-901-11(2) Copyright 2017 Sony Corporation

Digital Still Camera  
DSC-RX10M4

## Scene Selection

---

Allows you to shoot with preset settings according to the scene.

- 1 Set the mode dial to SCN (Scene Selection).
- 2 Turn the control dial to select the desired setting.

### Menu item details

#### **Portrait:**

Blurs background and sharpens the subject. Accentuates the skin tones softly.



#### **Sports Action:**

Shoots a moving subject at a fast shutter speed so that the subject looks as if it is standing still. The product shoots images continuously while the shutter button is pressed.



#### **Macro:**

Shoots close-ups of the subjects, such as flowers, insects, food, or small items.



#### **Landscape:**

Shoots the entire range of a scenery in sharp focus with vivid colors.



#### **Sunset:**

Shoots the red of the sunset beautifully.



### 🌙 Night Scene:

Shoots night scenes without losing the dark atmosphere.



### 👋 Hand-held Twilight:

Shoots night scenes with less noise and blur without using a tripod. A burst of shots are taken, and image processing is applied to reduce subject blur, camera-shake, and noise.



### 👤🌙 Night Portrait:

Shoots night scene portraits using the flash.

The flash does not pop up automatically. Pop up the flash manually before shooting.



### 👤👤 Anti Motion Blur:

Allows you to shoot indoor shots without using the flash and reduces subject blur. The product shoots burst images and combines them to create the image, reducing subject blur and noise.



#### Note

- Under the following settings, the shutter speed is slower, so use of a tripod is recommended to prevent the image from blurring:
  - [Night Scene]
  - [Night Portrait]
- In the [Hand-held Twilight] or [Anti Motion Blur] mode, the shutter clicks 4 times and an image is recorded.
- If you select [Hand-held Twilight] or [Anti Motion Blur] with [RAW] or [RAW & JPEG], the image quality becomes [Fine] temporarily.
- Reducing blur is less effective even in [Hand-held Twilight] or [Anti Motion Blur] when shooting the following subjects:
  - Subjects with erratic movement.
  - Subjects that are too close to the product.
  - Subjects with continuously similar patterns, such as the sky, a beach, or a lawn.
  - Subjects with constant change such as waves or water falls.



- In the case of [Hand-held Twilight] or [Anti Motion Blur], block noise may occur when using a light source that flickers, such as fluorescent lighting.
- The minimum distance that you can come close to a subject does not change even if you select [Macro]. For the minimum in-focus range, refer to the minimum distance of the lens attached to the product.

#### Hint

- To change the scene, rotate the control dial on the shooting screen and select a new scene.

---



#### Related Topic



- [Using flash](#)

4-725-901-11(2) Copyright 2017 Sony Corporation

Digital Still Camera  
DSC-RX10M4

## Recall (Camera Settings1/Camera Settings2)



Allows you to shoot an image after recalling often-used modes or camera settings registered with [1/2 Memory] in advance.

- 1 Set the mode dial to MR (Memory recall).
- 2 Press the left/right side of the control wheel or turn the control wheel to select the desired number, then press the center of the control wheel.
  - You can also recall registered modes or settings by selecting MENU → 1 (Camera Settings1) → [1/2 Recall].

### Hint

- To recall settings registered to the memory card, set the mode dial to MR (Memory recall), then select the desired number by pressing the left/right side of the control wheel.
- Settings registered to a memory card using another camera of the same model name can be recalled with this camera.

### Note

- If you set [1/2 Recall] after completing the shooting settings, the registered settings are given priority and the original settings may become invalid. Check the indicators on the screen before shooting.



### Related Topic

- [Memory \(Camera Settings1/Camera Settings2\)](#)

Digital Still Camera  
DSC-RX10M4

## Movie: Exposure Mode

You can set the exposure mode for movie shooting.

- 1 Set the mode dial to  (Movie).
- 2 MENU →  2 (Camera Settings2) → [ Exposure Mode] → desired setting.
- 3 Press the MOVIE (movie) button to start recording.
  - Press the MOVIE button again to stop recording.

### Menu item details

#### Program Auto:

Allows you to shoot with the exposure adjusted automatically (both the shutter speed and the aperture value).

#### Aperture Priority:

Allows you to shoot after adjusting the aperture value manually.

#### Shutter Priority:

Allows you to shoot after adjusting the shutter speed manually.

#### Manual Exposure:

Allows you to shoot after adjusting the exposure (both the shutter speed and the aperture value) manually.

#### Note

- When you adjust the aperture using the aperture ring while recording a movie, set the Aperture Click Switch to “OFF.” If you change the aperture value while shooting a movie with the Aperture Click Switch set to “ON,” the sound of the aperture ring will be recorded.

Digital Still Camera  
DSC-RX10M4

## HFR (High Frame Rate): Exposure Mode

---

You can select the exposure mode for HFR shooting based on the subject and effect you want.

- 1 Set the mode dial to **HFR** (High Frame Rate).
- 2 MENU →  2 (Camera Settings2) → [**HFR** Exposure Mode] → desired setting.

### Menu item details

#### **HFR** Program Auto:

Allows you to shoot with the exposure adjusted automatically (both the shutter speed and the aperture value).

#### **HFR** Aperture Priority:

Allows you to shoot after adjusting the aperture value manually.

#### **HFR** Shutter Priority:

Allows you to shoot after adjusting the shutter speed manually.

#### **HFR** Manual Exposure:

Allows you to shoot after adjusting the exposure (both the shutter speed and the aperture value) manually.

---

### Related Topic

- [Shooting super-slow-motion movies \(HFR Settings\)](#)

## Exposure Comp.

Normally, exposure is set automatically (auto exposure). Based on the exposure value set by auto exposure, you can make the entire image brighter or darker if you adjust [Exposure Comp.] to the plus side or minus side, respectively (exposure compensation).

### 1 Turn the exposure compensation dial (A).

**+ (over) side:**

Images become brighter.

**- (under) side:**

Images become darker.

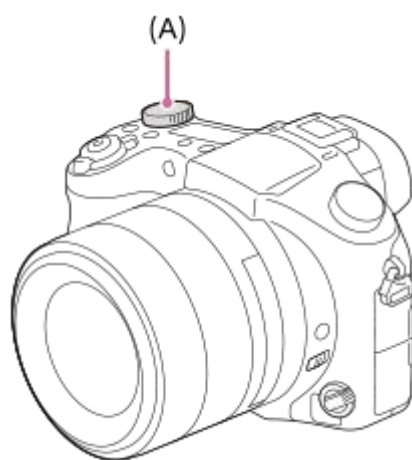

- You can adjust the exposure compensation value within the range of -3.0 EV to +3.0 EV.
- You can confirm the exposure compensation value that you set on the shooting screen.

**Monitor**

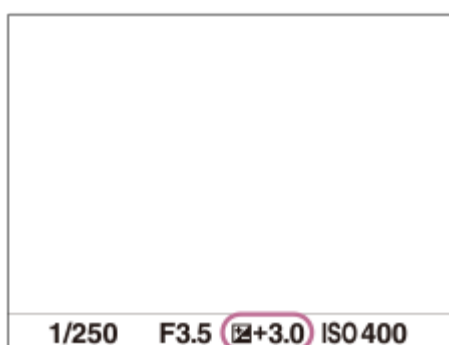

**Viewfinder**

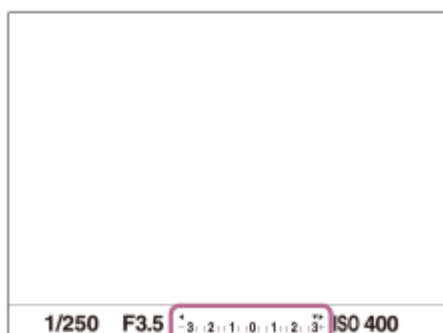

## To set the exposure compensation value using the MENU

You can adjust the exposure compensation value within a range of -3.0 EV to +3.0 EV when the exposure compensation dial is set to "0."

MENU →  1 (Camera Settings1) → [Exposure Comp.] → desired setting.

### Note

- You cannot perform the exposure compensation in the following shooting modes:
  - [Intelligent Auto]
  - [Superior Auto]
  - [Scene Selection]
- When using [Manual Exposure], you can perform the exposure compensation only when [ISO] is set to [ISO AUTO].
- The settings of the exposure compensation dial will be prioritized over [Exposure Comp.] in MENU.
- You can adjust the exposure compensation value within the range of -2.0 EV to +2.0 EV for movies.
- If you shoot a subject in extremely bright or dark conditions, or when you use the flash, you may not be able to get a satisfactory effect.
- When you set the exposure compensation dial to "0" from a setting other than "0," the exposure value switches to "0" regardless of the [Exposure Comp.] setting.

---

### Related Topic

- [Exp.comp.set](#)
- [Cont. Bracket](#)
- [Single Bracket](#)
- [Zebra](#)

Digital Still Camera  
DSC-RX10M4

## Reset EV Comp.

---

Sets whether to maintain the exposure value set using [Exposure Comp.] when you turn off the power when the exposure compensation dial position is set to “0.”

**1** MENU →  1 (Camera Settings1) → [Reset EV Comp.] → desired setting.

### Menu item details

**Maintain:**

Maintains the settings.

**Reset:**

Resets the settings.

Digital Still Camera  
DSC-RX10M4

## Exposure Set. Guide

---

You can set whether to display a guide when you change the exposure.

**1** MENU →  2 (Camera Settings2) → [Exposure Set. Guide] → desired setting.

### Menu item details

**Off:**

Does not display the guide.

**On:**

Displays the guide.

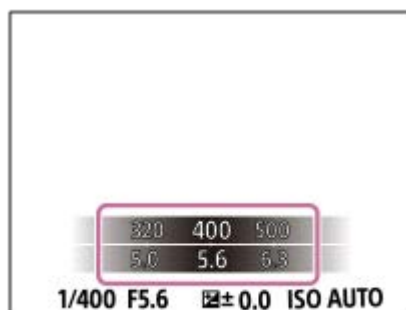



Digital Still Camera  
DSC-RX10M4

## Metering Mode

Selects the metering mode that sets which part of the screen to measure for determining the exposure.

1 MENU →  (Camera Settings1) → [Metering Mode] → desired setting.

### Menu item details

#### Multi:

Measures light on each area after dividing the total area into multiple areas and determines the proper exposure of the entire screen (Multi-pattern metering).

#### Center:

Measures the average brightness of the entire screen, while emphasizing the central area of the screen (Center-weighted metering).

#### Spot:

Measures only the central area (Spot metering). This mode is suitable for measuring light on a specified part of the entire screen. The size of the metering circle can be selected from [Spot: Standard] and [Spot: Large]. The position of the metering circle depends on the setting for [Spot Metering Point].

#### Entire Screen Avg.:

Measures the average brightness of the entire screen. The exposure will be stable even if the composition or the position of the subject changes.

#### Highlight:

Measures the brightness while emphasizing the highlighted area on the screen. This mode is suitable for shooting the subject while avoiding overexposure.

### Hint

- When [Spot] is selected and [Focus Area] is set to either [Flexible Spot] or [Expand Flexible Spot] while [Spot Metering Point] is set to [Focus Point Link], the spot metering point can be coordinated with the focus area.
- When [Metering Mode] is set to [Highlight] and the [D-Range Opt.] or [Auto HDR] function is activated, the brightness and the contrast will be corrected automatically by dividing the image into small areas and analyzing the contrast of light and shadow. Make settings based on the shooting circumstances.

### Note

- [Metering Mode] is locked to [Multi] in the following shooting modes:
  - [Intelligent Auto]
  - [Superior Auto]
  - [Scene Selection]
  - Other zoom functions than the optical zoom
- In [Highlight] mode, the subject may be dark if a brighter part exists on the screen.

### Related Topic

- [AE lock](#)
- [Spot Metering Point](#)
- [D-Range Opt. \(DRO\)](#)
- [Auto HDR](#)



Digital Still Camera  
DSC-RX10M4

## Spot Metering Point

---

Sets whether to coordinate the spot metering position with the focus area when [Focus Area] is set to [Flexible Spot] or [Expand Flexible Spot].

1 MENU →  (Camera Settings1) → [Spot Metering Point] → desired setting.

### Menu item details

#### Center:

The spot metering position does not coordinate with the focus area, but always meters brightness at the center.

#### Focus Point Link:

The spot metering position coordinates with the focus area.

#### Note

- When [Focus Area] is set to other than [Flexible Spot] or [Expand Flexible Spot], the spot metering position is locked to the center.
- When [Focus Area] is set to [Lock-on AF: Flexible Spot] or [Lock-on AF:Expand Flexible Spot], the spot metering position coordinates to the Lock-on AF start position, but does not coordinate with the tracking of the subject.

---

### Related Topic

- [Focus Area](#)
- [Metering Mode](#)

## AE lock

When the contrast between the subject and background is high, such as when shooting a backlit subject or a subject near a window, meter the light at a spot where the subject appears to have the appropriate brightness and lock the exposure before shooting. To reduce the brightness of the subject, meter the light at a spot brighter than the subject and lock the exposure of the entire screen. To make the subject brighter, meter the light at a spot darker than the subject and lock the exposure of the entire screen.

**1 Adjust the focus on the spot at which the exposure is adjusted.**

**2 Press the AEL button.**



The exposure is locked, and **\*** (AE lock) is displayed.



**3 Keep pressing the AEL button and focus on the subject again, then shoot the picture.**

- Keep holding the AEL button down while taking a shot if you want to continue shooting with the fixed exposure. Release the button to reset the exposure.

### Hint

- If you select the MENU →  2 (Camera Settings2) → [Custom Key(Shoot.)] → [AEL Button] → [AEL toggle], you can lock the exposure without holding down the button.

### Note



- [ AEL hold] and [ AEL toggle] are not available when using zoom functions other than optical zoom.

Digital Still Camera  
DSC-RX10M4

## AEL w/ shutter (still image)

---

Sets whether to fix the exposure when you press the shutter button halfway down.  
Select [Off] to adjust the focus and the exposure separately.

1 MENU →  (Camera Settings1) → [ AEL w/ shutter] → desired setting.

### Menu item details

#### Auto:

Fixes the exposure after adjusting the focus automatically when you press the shutter button halfway down with the focus mode dial turned to "S (Single-shot AF)." When focus mode is set to "A (Automatic AF)" and the product determines that the subject is moving, or you shoot burst images, the fixed exposure is cancelled.

#### On:

Fixes the exposure when you press the shutter button halfway down.

#### Off:

Does not fix the exposure when you press the shutter button halfway down. Use this mode when you want to adjust focus and exposure separately.

The product keeps adjusting the exposure while shooting in [Cont. Shooting] mode.

#### Note

- Operation using the AEL button is prioritized over the [ AEL w/ shutter] settings.

Digital Still Camera  
DSC-RX10M4

## Exposure Std. Adjust

Adjusts this camera's standard for the correct exposure value for each metering mode.

- 1 MENU →  1 (Camera Settings1) → [Exposure Std. Adjust] → desired metering mode.
- 2 Select the desired value as the metering standard.
  - You can set a value from -1 EV to +1 EV in 1/6 EV increments.

## Metering Mode

The set standard value will be applied when you select the corresponding metering mode in MENU →  1 (Camera Settings1) → [Metering Mode].

 Multi/  Center/  Spot/  Entire Screen Avg./  Highlight

### Note

- The exposure compensation will not be affected when [Exposure Std. Adjust] is changed.
- The exposure value will be locked according to the value set for [  Spot] during using spot AEL.
- The standard value for M.M (Metered Manual) will be changed according to the value set in [Exposure Std. Adjust].
- The value set in [Exposure Std. Adjust] is recorded in Exif data separately from the exposure compensation value. The amount of exposure standard value will not be added to the exposure compensation value.
- If you set [Exposure Std. Adjust] during bracketing shooting, the number of shots for the bracketing will be reset.

## Related Topic

- [Metering Mode](#)

Digital Still Camera  
DSC-RX10M4

## Exp.comp.set

---

Sets whether to apply the exposure compensation value to control both flash light and ambient light, or just ambient light.

**1** MENU →  (Camera Settings1) → [Exp.comp.set] → **desired setting.**

### Menu item details

**Ambient&flash:**

Applies the exposure compensation value to control both flash light and ambient light.

**Ambient only:**

Applies the exposure compensation value to control ambient light only.

---

### Related Topic

- [Flash Comp.](#)

Digital Still Camera  
DSC-RX10M4

## Zebra

The zebra pattern will appear over part of an image if the brightness level of that part meets the IRE level that you set. Use this zebra pattern as a guide to adjust the brightness.

**1** MENU →  2 (Camera Settings2) → [Zebra] → desired setting.

### Menu item details

#### Off:

Does not display the zebra pattern.

#### 70/75/80/85/90/95/100/100+/Custom1/Custom2:

Adjusts the brightness level.

#### Hint

- You can register values to check the correct exposure or overexposure as well as the brightness level for [Zebra]. The settings for correct exposure confirmation and overexposure confirmation are registered to [Custom1] and [Custom2] respectively in the default settings.
- To check the correct exposure, set a standard value and the range for the brightness level. The zebra pattern will appear on areas that fall within the range you set.
- To check the overexposure, set a minimum value for the brightness level. The zebra pattern will appear over areas with a brightness level equal to or higher than the value you set.

#### Note

- The zebra pattern is not displayed on devices connected via HDMI.



Digital Still Camera  
DSC-RX10M4

## D-Range Opt. (DRO)

By dividing the image into small areas, the product analyzes the contrast of light and shadow between the subject and the background, and creates an image with the optimal brightness and gradation.

- 1 MENU →  (Camera Settings1) → [DRO/Auto HDR] → [D-Range Opt.].
- 2 Select the desired setting using the left/right sides of the control wheel.

### Menu item details

#### D-Range Optimizer: Auto:

Corrects the brightness automatically.

#### D-Range Optimizer: Lv1 — D-Range Optimizer: Lv5:

Optimizes the gradation of a recorded image for each divided area. Select the optimization level from Lv1 (weak) to Lv5 (strong).

#### Note

- In the following situations, [D-Range Opt.] is fixed to [Off]:
  - The shooting mode is set to [Sweep Panorama].
  - Multi Frame NR
  - When [Picture Effect] is set to other than [Off]
  - When [Picture Profile] is set to other than [Off]
- [DRO/Auto HDR] is fixed to [Off] when the following modes are selected in [Scene Selection].
  - [Sunset]
  - [Night Scene]
  - [Night Portrait]
  - [Hand-held Twilight]
  - [Anti Motion Blur]

The setting is fixed to [D-Range Optimizer: Auto] when [Scene Selection] modes other than the above modes are selected.
- When [ Record Setting] is set to [120p 100M], [100p 100M], [120p 60M], or [100p 60M], [DRO/Auto HDR] switches to [Off].
- When shooting with [D-Range Opt.], the image may be noisy. Select the proper level by checking the recorded image, especially when you enhance the effect.

Digital Still Camera  
DSC-RX10M4

## Auto HDR

Shoots three images using different exposures and combines the images with correct exposure, the bright parts of an underexposed image, and the dark parts of an overexposed image to create images with a greater range of gradation (High Dynamic Range). One image with proper exposure and one overlaid image are recorded.

1 MENU →  1 (Camera Settings1) → [DRO/Auto HDR] → [Auto HDR].

2 Select the desired setting using the left/right sides of the control wheel.

### Menu item details

 **Auto HDR: Exposure Diff. Auto:**

Corrects the brightness automatically.

 **Auto HDR: Exposure Diff. 1.0EV — Auto HDR: Exposure Diff. 6.0EV:**



Sets the exposure difference, based on the contrast of the subject. Select the optimization level from 1.0EV (weak) to 6.0EV (strong).

For example, if you set the exposure value to 2.0 EV, three images will be composed with the following exposure levels: -1.0 EV, correct exposure and +1.0 EV.

#### Hint

- The shutter is released three times for one shot. Be careful about the following:
  - Use this function when the subject is motionless or does not flash light.
  - Do not change the composition before shooting.

#### Note

- This function is not available when the [ Quality] is [RAW] or [RAW & JPEG].
- [Auto HDR] is not available in the following shooting modes:
  - [Intelligent Auto]
  - [Superior Auto]
  - [Sweep Panorama]
  - [Scene Selection]
- [Auto HDR] is not available in the following situations:
  - When [Multi Frame NR] is selected.
  - When [Picture Effect] is set to other than [Off].
  - When [Picture Profile] is set to other than [Off].
- You cannot start the next shot until the capture process is completed after you shoot.
- You may not obtain the desired effect depending on the luminance difference of a subject and the shooting conditions.
- When the flash is used, this function has little effect.
- When the contrast of the scene is low or when product shake or subject blur occurs, you may not obtain good HDR images.   will be displayed over the recorded image to inform you when the camera detects image blurring. Change the composition or re-shoot the image carefully to avoid image blur, as needed.

## ISO

Sensitivity to light is expressed by the ISO number (recommended exposure index). The larger the number, the higher the sensitivity.

1 MENU →  (Camera Settings1) → [ISO] → desired setting.

### Menu item details

#### Multi Frame NR:

Combines continuous shots to create an image with less noise. Press the right side to display the setting screen, then select a desired value using the top/bottom sides of the control wheel.

Select the desired ISO number from ISO AUTO or ISO 100 – ISO 25600.

#### ISO AUTO:

Sets the ISO sensitivity automatically.

#### ISO 64 – ISO 12800:

Sets the ISO sensitivity manually. Selecting a larger number increases the ISO sensitivity.

#### Hint

- You can change the range of ISO sensitivity that is set automatically in [ISO AUTO] mode. Select [ISO AUTO] and press the right side of the control wheel, and set the desired values for [ISO AUTO Maximum] and [ISO AUTO Minimum].
- The values are also applied when shooting in [ISO AUTO] mode under [Multi Frame NR].
- You can set the effect level for noise reduction by selecting [NR Effect] under [Multi Frame NR].

#### Note

- When [Quality] is set to [RAW] or [RAW & JPEG], [Multi Frame NR] cannot be selected.
- When [Multi Frame NR] is selected, the flash, [D-Range Opt.], or [Auto HDR] cannot be used.
- When [Picture Profile] is set to other than [Off], [Multi Frame NR] cannot be selected.
- When [Picture Effect] is set to other than [Off], [Multi Frame NR] cannot be selected.
- [ISO AUTO] is selected when using the following functions:
  - [Intelligent Auto]
  - [Superior Auto]
  - [Scene Selection]
  - [Sweep Panorama]
- When the ISO sensitivity is set to a value lower than ISO 100, the range for recordable subject brightness (dynamic range) may decrease.
- The higher the ISO value, the more noise will appear on the images.
- The available ISO settings will differ depending on whether you are shooting still images, shooting movies, or using HFR.
- When shooting movies, ISO values between 100 and 12800 are available. If the ISO value is set to a value smaller than 100, the setting is automatically switched to 100. When you finish recording the movie, the ISO value returns to the original setting.
- When you use [Multi Frame NR], it takes some time for the product to perform the overlay processing of images.
- When you select [ISO AUTO] with the shooting mode set to [P], [A], [S] or [M], the ISO sensitivity will be automatically adjusted within the set range.



Digital Still Camera  
DSC-RX10M4

## ISO AUTO Min. SS

If you select [ISO AUTO] or [ISO AUTO] under [Multi Frame NR] when the shooting mode is P (Program Auto) or A (Aperture Priority), you can set the shutter speed at which the ISO sensitivity starts changing.

This function is effective for shooting moving subjects. You can minimize subject blurring while also preventing camera shake.

1 MENU →  1 (Camera Settings1) → [ISO AUTO Min. SS] → desired setting.

### Menu item details

#### **FASTER (Faster)/FAST (Fast):**

The ISO sensitivity will start to change at shutter speeds faster than [Standard], so you can prevent camera shake and subject blurring.

#### **STD (Standard):**

The camera automatically sets the shutter speed based on the focal length of the lens.

#### **SLOW (Slow)/SLOWER (Slower):**

The ISO sensitivity will start to change at shutter speeds slower than [Standard], so you can shoot images with less noise.



#### **1/32000 — 30":**

The ISO sensitivity starts to change at the shutter speed you have set.

#### Hint

- The difference in shutter speed at which ISO sensitivity starts to change between [Faster], [Fast], [Standard], [Slow], and [Slower] is 1 EV.

#### Note

- If the exposure is insufficient even when the ISO sensitivity is set to [ISO AUTO Maximum] in [ISO AUTO], in order to shoot with an appropriate exposure, the shutter speed will be slower than the speed set in [ISO AUTO Min. SS].
- In the following situations, the shutter speed may not function as set:
  - When the maximum shutter speed has changed based on the aperture or the [ Shutter Type] setting.
  - When using the flash to shoot bright scenes with the [ Shutter Type] set to [Electronic Shut.]. (The maximum shutter speed is limited to the flash-syncing speed of 1/100 second.)
  - When using the flash to shoot dark scenes with the [Flash Mode] set to [Fill-flash] or [Wireless]. (The minimum shutter speed is limited to the speed automatically determined by the camera.)

### Related Topic

- [Program Auto](#)
- [Aperture Priority](#)
- [ISO](#)

Digital Still Camera  
DSC-RX10M4

## The zoom features available with this product

The zoom feature of the product provides a higher magnification zoom by combining various zoom features. The icon displayed on the screen changes, according to the selected zoom feature.

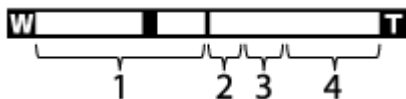

### 1. Optical zoom range

Images are magnified within the optical zoom range of this product.

### 2. Smart Zoom range ( )

Zoom images without causing the original quality to deteriorate by partially cropping an image (only when the image size is [M], [S] or [VGA]).





### 3. Clear Image Zoom range ( )

Zoom images using an image process with less deterioration. When you set [Zoom Setting] to [On:ClearImage Zoom] or [On:Digital Zoom], you can use this zoom function.

### 4. Digital Zoom range ( )

You can magnify images using an image process. When you set [Zoom Setting] to [On:Digital Zoom], you can use this zoom function.

#### Note

- The default setting for the [Zoom Setting] is [Optical zoom only].
- The default setting for the [ Image Size] is [L]. To use the smart zoom, change [ Image Size] to [M], [S] or [VGA].
- Zooming is not available when shooting panoramic images.
- Zoom functions other than the optical zoom are not available when shooting in the following situations:
  - [ Quality] is set to [RAW] or [RAW & JPEG].
  - [ Record Setting] is set to [120p]/[100p].
  - The mode dial is set to **HFR** (High Frame Rate).
  - The smart teleconverter function is assigned to one of the custom keys.
- You cannot use the Smart Zoom function with movies.
- Zooming is not available when the screen is set to HFR (High Frame Rate) shooting.
- When you use a zoom function other than the optical zoom, [Metering Mode] is fixed to [Multi].
- When using a zoom function other than the optical zoom, the following functions are not available:
  - Smile/Face Detect.
  - Lock-on AF
  -  Auto Obj. Framing

#### Related Topic

- [Zoom](#)
- [Zoom Setting](#)
- [About zoom scale](#)
- [Zoom Speed](#)



Digital Still Camera  
DSC-RX10M4

## Zoom



---

Enlarge images using the rear lens ring or the W/T (zoom) lever when shooting.

### 1 Enlarge images using the rear lens ring or the W/T (zoom) lever.

- Turn the rear lens ring to the right to zoom in and to the left to zoom out.
- Move the W/T (zoom) lever to the T side to zoom in and to the W side to zoom out.

#### Hint

- When you select other than [Optical zoom only] for [Zoom Setting], you can exceed the zoom range of the optical zoom to zoom images.
- You can assign the zoom function to the front lens ring by selecting MENU →  2 (Camera Settings2) → [Lens Ring Setup].
- You can assign the zoom in (T) and zoom out (W) functions to either rotational direction of the lens ring to which the zoom function has been assigned by selecting MENU →  2 (Camera Settings2) → [Zoom Ring Rotate].

---

#### Related Topic

- [Zoom Setting](#)
- [The zoom features available with this product](#)
- [Zoom Speed](#)
- [Zoom Func. on Ring](#)
- [Lens Ring Setup](#)
- [Zoom Ring Rotate](#)



Digital Still Camera  
DSC-RX10M4

## Zoom Setting

---

You can select the zoom setting of the product.

**1** MENU →  2 (Camera Settings2) → [Zoom Setting] → desired setting.

### Menu item details

#### Optical zoom only:

Limits the zoom range to the optical zoom. You can use the Smart Zoom function if you set [  Image Size] to [M], [S] or [VGA].

#### On:ClearImage Zoom:

Select this setting to use Clear Image Zoom. Even if the zoom range exceeds the optical zoom, the product magnifies images within the range in which image quality does not deteriorate significantly.

#### On:Digital Zoom:

When the zoom range of the Clear Image Zoom is exceeded, the product magnifies images to the largest scale. However, the image quality will deteriorate.

#### Note

- Set [Optical zoom only] if you want to magnify images within the range in which image quality does not deteriorate.

---

### Related Topic

- [The zoom features available with this product](#)
- [About zoom scale](#)
- [Zoom Speed](#)

Digital Still Camera  
DSC-RX10M4

## About zoom scale

The zoom scale that is used in combination with the zoom of the lens changes according to the selected image size.

When [ Aspect Ratio] is [3:2]

 Image Size	Zoom Setting		
	Optical zoom only (smart zoom)	On:ClearImage Zoom	On:Digital Zoom
L: 20M	-	Approx. 2.0×	Approx. 4.0×
M: 10M	Approx. 1.4×	Approx. 2.8×	Approx. 5.6×
S: 5.0M	Approx. 2.0×	Approx. 4.0×	Approx. 8.0×

### Related Topic

- [Zoom](#)
- [The zoom features available with this product](#)
- [Zoom Setting](#)
- [Image Size \(still image\)](#)

## Zoom Assist

Zooms out temporarily and displays wider area when shooting a subject at the telephoto end (T end) of the zoom range. Quickly locates subjects you have lost track of and makes it easier to compose your shot. Be sure to assign the [Zoom Assist] function to a key using [Custom Key(Shoot.)] in advance.

### 1 Hold down the key to which you have assigned [Zoom Assist].

The zoom scale will become lower and the shooting screen display will zoom out. The angle of view before the key was pressed is displayed as a frame (A: zoom assist frame).

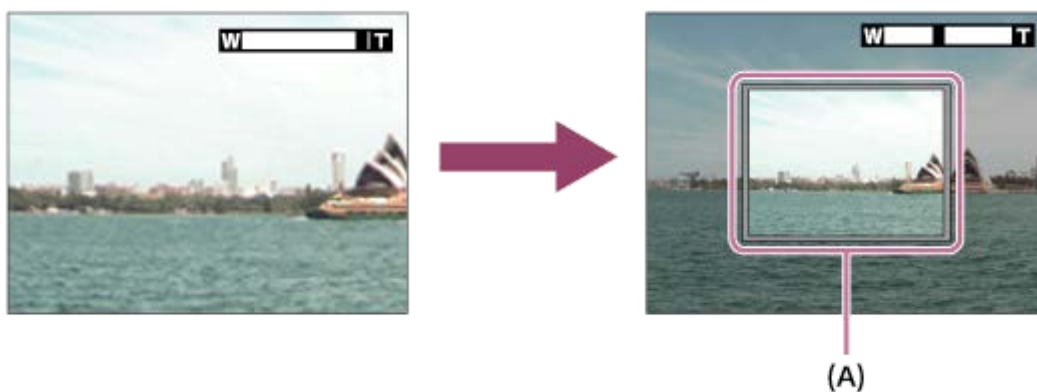

### 2 Compose your shot so that the subject fits inside the zoom assist frame, and release the key.

The previous zoom scale is restored and the area inside the zoom assist frame is displayed full-screen.

#### Hint

- You can change the size of the zoom assist frame by using the standard zoom function while pressing the key to which [Zoom Assist] has been assigned. After you release the key, the zoom scale changes to the new size of the zoom assist frame.
- You can change how much to zoom out by selecting MENU →  2 (Camera Settings2) → [Rng. of Zoom Assist].

#### Note

- If you press the shutter button all the way down while pressing the key, the previous zoom scale will not be restored and shooting will be performed with the angle of view set during zoom assist.
- When you use the [Zoom Assist] function during movie shooting, the captured area is not displayed inside the zoom assist frame but on the screen. In addition, the zoom sound may be recorded.

#### Related Topic

- [Custom Key\(Shoot.\)/Custom Key\(PB\)](#)
- [Rng. of Zoom Assist](#)

Digital Still Camera  
DSC-RX10M4

## Rng. of Zoom Assist

---

Selects how much to zoom out with the [Zoom Assist] function.

**1** MENU →  **2** (Camera Settings2) → [Rng. of Zoom Assist] → desired setting.

### Menu item details

**S:**

Zooms out a small amount.

**M:**

Zooms out a medium amount.

**L:**

Zooms out a large amount.

---

### Related Topic

- [Zoom Assist](#)

Digital Still Camera  
DSC-RX10M4

## Zoom Speed

---

Sets the zoom speed of the camera's zoom lever.

1 MENU →  2 (Camera Settings2) → [Zoom Speed] → desired setting.

### Menu item details

#### Normal:

Sets the zoom speed of the zoom lever to normal.

#### Fast:

Sets the zoom speed of the zoom lever to fast.

#### Hint

- The [Zoom Speed] settings are also used when you are zooming with a remote controller (sold separately) connected to the camera.

#### Note

- Selecting [Fast] increases the likelihood that the zoom sound will be recorded.

---

### Related Topic

- [Zoom](#)
- [The zoom features available with this product](#)
- [Zoom Setting](#)

Digital Still Camera  
DSC-RX10M4

## Zoom Ring Rotate

---

Assigns zoom in (T) or zoom out (W) functions to the rotational directions of the lens ring to which the zoom function has been assigned.

1 MENU →  2 (Camera Settings2) → [Zoom Ring Rotate] → desired setting.

### Menu item details

#### Left(W)/Right(T):

Assigns zoom out (W) function to left-handed rotation and zoom-in (T) function to right-handed rotation.

#### Right(W)/Left(T):

Assigns zoom in (T) function to left-handed rotation and zoom-out (W) function to right-handed rotation.

---

### Related Topic

- [Lens Ring Setup](#)

Digital Still Camera  
DSC-RX10M4

## Smart Telecon.

---

Smart Teleconverter magnifies and trims the center of the image, then records it.

**1** MENU →  **2** (Camera Settings2) → [Custom Key(Shoot.)] → assign the [Smart Telecon.] function to the desired key.

**2** Magnify an image by pressing the key to which you have assigned [Smart Telecon.].

The settings change each time you press the key.

---

### Related Topic

- [Custom Key\(Shoot.\)/Custom Key\(PB\)](#)

Digital Still Camera  
DSC-RX10M4

## Zoom Func. on Ring

---

Sets the zoom functions when using the lens ring to change zoom scales.

1 MENU →  2 (Camera Settings2) → [Zoom Func. on Ring] → desired setting.

### Menu item details

**Standard:**

Zooms in/out smoothly when you operate the zoom by turning the lens ring.

**Quick:**

Zooms in/out to an angle of view corresponding to how far the lens ring has been rotated.

**Step:**

Zooms in/out at certain angle steps when you operate the zoom by turning the lens ring.

**Note**

- In the following situations, the zoom function activates as if [Zoom Func. on Ring] is set to [Standard], even if it is set to [Step].
  - When using the W/T (zoom) lever to change the zoom scale.
  - When recording movies.
  - When using zoom functions other than the optical zoom.
- Selecting [Quick] increases the likelihood that the zoom sound will be recorded.







Digital Still Camera  
DSC-RX10M4

## White Balance

Corrects the tone effect of the ambient light condition to record a neutral white subject in white. Use this function when the color tones of the image did not come out as you expected, or when you want to change the color tones on purpose for photographic expression.

1 MENU →  1 (Camera Settings1) → [White Balance] → desired setting.

### Menu item details

**AWB**  **AWB**  **Auto** /  **Daylight** /  **Shade** /  **Cloudy** /  **Incandescent** /  **-1 Fluor.: Warm White** /  **0 Fluor.: Cool White** /  **+1 Fluor.: Day White** /  **+2 Fluor.: Daylight** /  **Flash**: When you select a light source that illuminates the subject, the product adjusts the color tones to suit to the selected light source (preset white balance). When you select [Auto], the product automatically detects the light source and adjusts the color tones.

 **C.Temp./Filter**:

Adjusts the color tones depending on the light source. Achieves the effect of CC (Color Compensation) filters for photography.

 **Custom 1/Custom 2/Custom 3**:



Uses the white balance setting saved in [Custom Setup].

 **SET Custom Setup**:

Memorizes the basic white color under the light conditions for the shooting environment.

Select a memorized custom white balance number.

### Hint

- You can display the fine adjustment screen and perform fine adjustments of the color tones as required by pressing the right side of the control wheel.
- If the color tones do not come out as you expected in the selected settings, perform [WB bracket] shooting.
- **AWB**  or **AWB**  is displayed only when [Priority Set in AWB] is set to [Ambience] or [White].

### Note

- [White Balance] is fixed to [Auto] in the following shooting modes:
  - [Intelligent Auto]
  - [Superior Auto]
  - [Scene Selection]
- If you use a mercury lamp or a sodium lamp as a light source, the accurate white balance will not be obtained because of the characteristics of the light. It is recommended to shoot images using a flash or select [Custom Setup].

### Related Topic

- [Capturing a basic white color in \[Custom Setup\] mode](#)
- [Priority Set in AWB](#)
- [WB bracket](#)

Digital Still Camera  
DSC-RX10M4

## Priority Set in AWB

---

Selects which tone to prioritize when shooting under lighting conditions such as incandescent light when [White Balance] is set to [Auto].

1 MENU →  1 (Camera Settings1) → [Priority Set in AWB] → desired setting.

### Menu item details

AWB  
STD **Standard:**

Shoots with standard auto white balance. The camera automatically adjusts the color tones.

AWB  
Ambi **Ambience:**

Prioritizes the color tone of the light source. This is suitable when you want to produce a warm atmosphere.

AWB  
White **White:**

Prioritizes a reproduction of white color when the color temperature of the light source is low.

---

### Related Topic

- [White Balance](#)

## Capturing a basic white color in [Custom Setup] mode

In a scene where the ambient light consists of multiple types of light sources, it is recommended to use the custom white balance in order to accurately reproduce the whiteness. You can register 3 settings.

**1** MENU →  1 (Camera Settings1) → [White Balance] → [Custom Setup].

**2** Hold the product so that the white area fully covers the circle located in the center of the screen, and then press the center of the control wheel.

After the shutter sound beeps, the calibrated values (Color Temperature and Color Filter) are displayed.

**3** Select a registration number using the left/right sides of the control wheel, and then press the center.

The monitor returns to the recording information display while retaining the memorized custom white balance setting.

- The registered custom white balance setting will remain memorized until overwritten by the another setting.

### Note

- The message [Custom WB Error] indicates that the value is in the unexpected range, for example when the subject is too vivid. You can register the setting at this point, but it is recommended that you set the white balance again. When an error value is set, the indicator  turns orange on the recording information display. The indicator will be displayed in white when the set value is in the expected range.
- If you use a flash when capturing a shot, the custom white balance will be registered with the flash light. Shoot images with a flash when recalling a setting registered with the flash.

## Creative Style

Allows you to set the desired image processing and finely adjust contrast, saturation and sharpness for each image style. You can adjust exposure (shutter speed and aperture) as you like with this function, unlike with [Scene Selection], where the product adjusts the exposure.

- 1 MENU → 1 (Camera Settings1) → [Creative Style].
- 2 Select the desired style or [Style Box] using the top/bottom sides of the control wheel.
- 3 To adjust (Contrast), (Saturation) and (Sharpness), select the desired item using the right/left sides, and then select the value using the top/bottom sides.

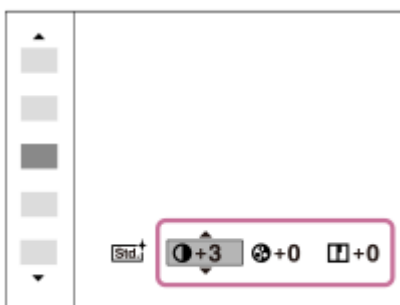

- 4 When selecting [Style Box], move to the right side using the right side of the control wheel, and then select the desired style.

- You can call up the same style with slightly different settings.

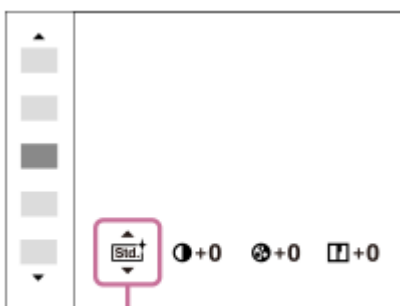

(A)

(A): Displayed only when Style Box is selected

### Menu item details

#### Standard:

For shooting various scenes with rich gradation and beautiful colors.

#### Vivid:

The saturation and contrast are heightened for shooting striking images of colorful scenes and subjects such as flowers, spring greenery, blue sky, or ocean views.

### **Neutral:**

The saturation and sharpness are lowered for shooting images in subdued tones. This is also suitable for capturing image material to be modified with a computer.

### **Clear:**

For shooting images in clear tones with limpid colors in highlight, suitable for capturing radiant light.

### **Deep:**

For shooting images with deep and dense colors, suitable for capturing the solid presence of the subject.

### **Light:**

For shooting images with bright and simple colors, suitable for capturing a refreshingly light ambience.

### **Portrait:**

For capturing skin in a soft tone, ideally suited for shooting portraits.

### **Landscape:**

The saturation, contrast, and sharpness are heightened for shooting vivid and crisp scenery. Distant landscapes also stand out more.

### **Sunset:**

For shooting the beautiful red of the setting sun.

### **Night Scene:**

The contrast is lowered for reproducing night scenes.

### **Autumn leaves:**

For shooting autumn scenes, vividly highlighting the reds and yellows of changing leaves.

### **Black & White:**

For shooting images in black and white monotone.

### **Sepia:**

For shooting images in sepia monotone.

### **Registering preferred settings (Style Box):**

Select the six style box (the boxes with numbers on the left side ()) to register preferred settings. Then select the desired settings using the right button.

You can call up the same style with slightly different settings.

## To set [Contrast], [Saturation] and [Sharpness]

[Contrast], [Saturation], and [Sharpness] can be adjusted for each image style preset such as [Standard] and [Landscape], and for each [Style Box] to which you can register preferred settings.

Select an item to be set by pressing the right/left sides of the control wheel, then set the value using the top/bottom sides of the control wheel.

### **Contrast:**

The higher the value selected, the more the difference of light and shadow is accentuated, and the bigger the effect on the image.

### **Saturation:**

The higher the value selected, the more vivid the color. When a lower value is selected, the color of the image is restrained and subdued.

### **Sharpness:**

Adjusts the sharpness. The higher the value selected, the more the contours are accentuated, and the lower the value selected, the more the contours are softened.

#### Note

- [Creative Style] is fixed to [Standard] in the following situations:
  - [Intelligent Auto]
  - [Superior Auto]
  - [Scene Selection]
  - [Picture Effect] is set to other than [Off].
  - [Picture Profile] is set to other than [Off].
- When this function is set to [Black & White] or [Sepia], [Saturation] cannot be adjusted.



Digital Still Camera  
DSC-RX10M4

## Picture Effect

Select the desired effect filter to achieve more impressive and artistic images.

1 MENU →  (Camera Settings1) → [Picture Effect] → desired setting.

### Menu item details



**Off:**

Disables the [Picture Effect] function.



**Toy Camera:**

Creates a soft image with shaded corners and reduced sharpness.



**Pop Color:**

Creates a vivid look by emphasizing color tones.



**Posterization:**

Creates a high contrast, abstract look by heavily emphasizing primary colors, or in black and white.



**Retro Photo:**

Creates the look of an aged photo with sepia color tones and faded contrast.



**Soft High-key:**

Creates an image with the indicated atmosphere: bright, transparent, ethereal, tender, soft.



**Partial Color:**

Creates an image which retains a specific color, but converts others to black and white.



**High Contrast Mono.:**

Creates a high-contrast image in black and white.



**Soft Focus:**

Creates an image filled with a soft lighting effect.



**HDR Painting:**

Creates the look of a painting, enhancing the colors and details.



**Rich-tone Mono.:**

Creates an image in black and white with rich gradation and reproduction of details.



**Miniature:**

Creates an image which enhances the subject vividly, with the background defocused considerably. This effect may often be found in pictures of miniature models.



**Watercolor:**

Creates an image with ink bleed and blurring effects as if painted using watercolors.



**Illustration:**

Creates an illustration-like image by emphasizing the outlines.

### Hint

- You can perform detailed settings for some items using the left/right sides of the control wheel.

### Note

- When you use a zoom function other than the optical zoom, setting the zoom scale larger makes [Toy Camera] less effective.
- When [Partial Color] is selected, images may not retain the selected color, depending on the subject or shooting conditions.
- You cannot check the following effects on the shooting screen, because the product processes the image after the shot. Also, you cannot shoot another image until image processing is finished. You cannot use these effects with movies.
  - [Soft Focus]

- [HDR Painting]
  - [Rich-tone Mono.]
  - [Miniature]
  - [Watercolor]
  - [Illustration]
- In the case of [HDR Painting] and [Rich-tone Mono.], the shutter is released three times for one shot. Be careful about the following:
    - Use this function when the subject is motionless or does not flash light.
    - Do not change the composition during shooting.

When the contrast of the scene is low or when significant camera-shake or subject blur has occurred, you may not be able to obtain good HDR images. If the product detects such a situation,  appear on the recorded image to inform you of this situation. Change the composition or re-shoot the image carefully to avoid image blur, as needed.



- This function is not available in the following shooting modes:
  - [Intelligent Auto]
  - [Superior Auto]
  - [Scene Selection]
  - [Sweep Panorama]
- When [ Quality] is set to [RAW] or [RAW & JPEG], this function is not available.



Digital Still Camera  
DSC-RX10M4

## Soft Skin Effect (still image)

Sets the effect used for shooting the skin smoothly in the Face Detection function.

1 MENU →  1 (Camera Settings1) → [ Soft Skin Effect] → desired setting.

### Menu item details

 Off:

Does not use the [ Soft Skin Effect] function.





 On:

Uses the [ Soft Skin Effect].

### Hint

- When [ Soft Skin Effect] is set to [On], you can select the effect level. Select the effect level by pressing the right/left side of the control wheel.

### Note

- [ Soft Skin Effect] is not available when [ Quality] is [RAW].
- [ Soft Skin Effect] is not available for RAW images when the [ Quality] is [RAW & JPEG].

Digital Still Camera  
DSC-RX10M4

## Auto Obj. Framing (still image)

When this product detects and shoots faces, macro shooting subjects or subjects that are tracked by [Lock-on AF], the product automatically trims the image into an appropriate composition, and then saves it. Both the original and the trimmed images are saved. The trimmed image is recorded in the same size as the original image size.

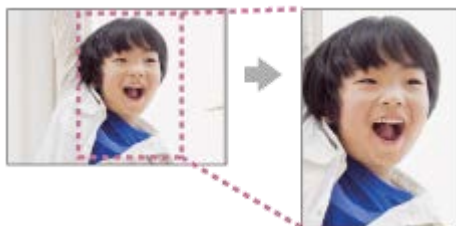

1 MENU → 1 (Camera Settings1) → [ Auto Obj. Framing] → desired setting.

### Menu item details

#### Off:

Does not trim images.

#### Auto:

Automatically trims images into an appropriate composition.



#### Note

- [ Auto Obj. Framing] is not available when the shooting mode is set to [Sweep Panorama], [Movie], or [High Frame Rate], or when [Scene Selection] is set to [Hand-held Twilight], [Sports Action], or [Anti Motion Blur].
- The trimmed image may not be the best possible composition, depending on the shooting conditions.
- [ Auto Obj. Framing] cannot be set when [ Quality] is set to [RAW] or [RAW & JPEG].
- [ Auto Obj. Framing] is not available in the following situations.
  - [Drive Mode] is set to [Cont. Shooting], [Self-timer(Cont)], [Cont. Bracket], [Single Bracket], [WB bracket], or [DRO Bracket].
  - The ISO sensitivity is set to [Multi Frame NR].
  - [DRO/Auto HDR] is set to [Auto HDR].
  - Other zoom functions than the optical zoom
  - When shooting in Manual Focus mode
  - [Picture Effect] is set to [Soft Focus], [HDR Painting], [Rich-tone Mono.], [Miniature], [Watercolor], or [Illustration].

Digital Still Camera  
DSC-RX10M4

## Color Space (still image)

The way colors are represented using combinations of numbers or the range of color reproduction is called “color space.” You can change the color space depending on the purpose of the image.

1 MENU →  (Camera Settings1) → [ Color Space] → desired setting.

### Menu item details

#### sRGB:

This is the standard color space of the digital camera. Use [sRGB] in normal shooting, such as when you intend to print out the images without any modification.

#### AdobeRGB:

This color space has a wide range of color reproduction. When a large part of the subject is vivid green or red, Adobe RGB is effective. The file name of the recorded image starts with “\_.”

#### Note

- [AdobeRGB] is for applications or printers that support color management and DCF2.0 option color space. Images may not be printed or viewed in the correct colors if you use applications or printers that do not support Adobe RGB.
- When displaying images that were recorded with [AdobeRGB] on non-Adobe RGB-compliant devices, the images will be displayed with low saturation.

Digital Still Camera  
DSC-RX10M4

## Release w/o Card

---

Sets whether the shutter can be released when no memory card has been inserted.

**1** MENU →  2 (Camera Settings2) → [Release w/o Card] → desired setting.

### Menu item details

**Enable:**

Releases the shutter even if no memory card has been inserted.

**Disable:**

Does not release the shutter when no memory card has been inserted.



**Note**

- When no memory card has been inserted, the images shot will not be saved.
- The default setting is [Enable]. It is recommended that you select [Disable] prior to actual shooting.

Digital Still Camera  
DSC-RX10M4

## Shutter Type (still image)

You can set whether to shoot with a mechanical shutter or an electronic shutter.

1 MENU →  2 (Camera Settings2) → [ Shutter Type] → desired setting.

### Menu item details

#### Auto:

The shutter type is automatically switched based on the shooting conditions and shutter speed.



#### Mechanical Shut.:

Shoot with the mechanical shutter only.





#### Electronic Shut.:

Shoot with the electronic shutter only.

#### Hint

- In the following situations, set the [ Shutter Type] to [Auto] or [Electronic Shut.].
  - When shooting with a high-speed shutter in a bright environment such as outside in bright sunlight, the beach, or snowy mountains.
  - When you want to increase the speed of continuous shooting.
- In the following situations, set the [ Shutter Type] to [Auto] or [Mechanical Shut.].
  - When you want to use the flash with a shutter speed faster than 1/100 second.
  - When you are concerned about distortion in the image due to the movement of the subject or the movement of the camera.

#### Note

- When shooting with the electronic shutter, there may be distortion in the image due to the movement of the subject or the camera itself.
- During shooting with the electronic shutter, band-like light-and-dark shading may appear when shooting under flickering light such as fluorescent light or instantaneous light (such as the flash of another camera).
- In rare cases, the shutter sound may be produced when the power is turned off even if the [ Shutter Type] is set to [Electronic Shut.]. However, this is not a malfunction.
- In the following situations, the mechanical shutter will be activated even if the [ Shutter Type] is set to [Electronic Shut.].
  - When capturing a basic white color in [Custom Setup] for [White Balance]
  - [Face Registration]
- The following functions are unavailable when the [ Shutter Type] is set to [Electronic Shut.].
  -  Long Exposure NR
  - Bulb shooting
- When using an external flash, the highest shutter speed you can set is 1/4000 seconds. However, because this shutter speed uses the electronic shutter, a belt-like contrast may be recorded on the image. If this occurs, set the [ Shutter Type] to [Mechanical Shut.].

### Related Topic

- [Using flash](#)





Digital Still Camera  
DSC-RX10M4

## SteadyShot (still image)

---

Sets whether or not to use the SteadyShot function.

**1** MENU →  2 (Camera Settings2) → [ SteadyShot] → **desired setting.**

### Menu item details

**On:**

Uses [ SteadyShot].

**Off:**



Does not use [ SteadyShot].

We recommend that you set the camera to [Off] when using a tripod.

Digital Still Camera  
DSC-RX10M4

## Long Exposure NR (still image)

When you set the shutter speed to 1/3 second(s) or longer (long exposure shooting), noise reduction is turned on for the duration that the shutter is open. With the function turned on, the grainy noise typical of long exposures is reduced.

1 MENU →  (Camera Settings1) → [ Long Exposure NR] → desired setting.

### Menu item details





#### On:

Activates noise reduction for the same duration that the shutter is open. When noise reduction is in progress, a message appears and you cannot take another picture. Select this to prioritize the image quality.

#### Off:

Does not activate noise reduction. Select this to prioritize the timing of shooting.

#### Note



- [ Long Exposure NR] is not available when [ Shutter Type] is set to [Electronic Shut.].
- Noise reduction may not be activated even if [ Long Exposure NR] is set to [On] in the following situations:
  - The shooting mode is set to [Sweep Panorama].
  - [Drive Mode] is set to [Cont. Shooting] or [Cont. Bracket].
  - The shooting mode is set to [Scene Selection] and [Sports Action], [Hand-held Twilight] or [Anti Motion Blur] is selected.
  - The ISO sensitivity is set to [Multi Frame NR].
- [ Long Exposure NR] cannot be set to [Off] in the following shooting modes:
  - [Intelligent Auto]
  - [Superior Auto]
  - [Scene Selection]
- Depending on the shooting conditions, the camera may not perform noise reduction, even if the shutter speed is 1/3 second(s) or longer.



Digital Still Camera  
DSC-RX10M4

## High ISO NR (still image)

When shooting with high ISO sensitivity, the product reduces noise that becomes more noticeable when the product sensitivity is high.

1 MENU →  1 (Camera Settings1) → [ High ISO NR] → desired setting.

### Menu item details

**Normal:**

Activates high ISO noise reduction normally.





**Low:**

Activates high ISO noise reduction moderately.

**Off:**

Does not activate high ISO noise reduction. Select this to prioritize the timing of shooting.

**Note**

- [ High ISO NR] is not available in the following shooting modes:
  - [Intelligent Auto]
  - [Superior Auto]
  - [Scene Selection]
  - [Sweep Panorama]
- When [ Quality] is set to [RAW], this function is not available.
- [ High ISO NR] does not work for RAW images when the [ Quality] is [RAW & JPEG].

Digital Still Camera  
DSC-RX10M4

## Smile/Face Detect.

Detects the faces of your subjects and adjusts the focus, exposure, flash settings and performs image processing automatically.

1 MENU →  (Camera Settings1) → [Smile/Face Detect.] → desired setting.

### Menu item details

#### Off:

Does not use the [Face Detection] function.

#### On (Regist. Faces):

Detects the registered face with higher priority using [Face Registration].

#### On:

Detects a face without giving higher priority to the registered face.

#### Smile Shutter:

Automatically detects and shoots a smile.

### Face Detection frame

- When the product detects a face, the gray face detection frame appears. When the product determines that autofocus is enabled, the face detection frame turns white. When a person's eyes are in focus and [Focus Mode] is set to [Single-shot AF], a green focus frame appears around the eyes for a certain period of time.
- In case you have registered the priority order for each face using [Face Registration], the product automatically selects the first prioritized face and the face detection frame over that face turns white. The face detection frames of other registered faces turn reddish-purple.



### Tips for capturing smiles more effectively

- Do not cover the eyes with front hair and keep the eyes narrowed.
- Do not obscure the face by a hat, masks, sunglasses, etc.
- Try to orient the face in front of the product and be as level as possible.
- Give a clear smile with an open mouth. The smile is easier to be detected when the teeth are shown.
- If you press the shutter button during Smile Shutter, the product shoots the image. After shooting, the product returns to Smile Shutter mode.

#### Hint

- When the [Smile/Face Detect.] is set to [Smile Shutter], you can select the Smile Detection Sensitivity from [On: Slight Smile], [On: Normal Smile] and [On: Big Smile].

#### Note

- You cannot use the Face Detection function with the following functions:

- Other zoom functions than the optical zoom
  - [Sweep Panorama]
  - [Picture Effect] is set to [Posterization].
  - When using the [Focus Magnifier] function.
  - [Scene Selection] is set to [Landscape], [Night Scene], [Sunset].
  - Movie shooting with [  Record Setting] set to [120p]/[100p].
  - During High Frame Rate shooting
- 
- Up to 8 faces of your subjects can be detected.
  - The product may not detect faces at all or may accidentally detect other objects as faces in some conditions.
  - If the product cannot detect a smile, adjust the Smile Detection Sensitivity.
  - If you track a face using [Lock-on AF] while executing Smile Shutter function, Smile Detection is performed only for that face.

## Face Registration (New Registration)

---

If you register faces in advance, the product can detect the registered face as a priority when [Smile/Face Detect.] is set to [On (Regist. Faces)].

- 1 MENU →  (Camera Settings1) → [Face Registration] → [New Registration].
- 2 Align the guide frame with the face to be registered, and press the shutter button.
- 3 When a confirmation message appears, select [Enter].

### Note

- Up to eight faces can be registered.
- Shoot the face from the front in a brightly lit place. The face may not be registered correctly if it is obscured by a hat, a mask, sunglasses, etc.

---

### Related Topic

- [Smile/Face Detect.](#)

Digital Still Camera  
DSC-RX10M4

## Face Registration (Order Exchanging)

---

When multiple faces are registered to be given priority, the face registered first will be given priority. You can change the priority order.

- 1 MENU →  1 (Camera Settings1) → [Face Registration] → [Order Exchanging].
- 2 Select a face to change the order of priority.
- 3 Select the destination.

---

### Related Topic

- [Smile/Face Detect.](#)

Digital Still Camera  
DSC-RX10M4

## Face Registration (Delete)

---

Deletes a registered face.

**1** MENU →  (Camera Settings1) → [Face Registration] → [Delete].

If you select [Delete All], you can delete all registered faces.

### Note

- Even if you execute [Delete], the data for registered face will remain in the product. To delete the data for registered faces from the product, select [Delete All].

## Using flash

In dark environments, use the flash to light up the subject while shooting. Also use the flash to prevent camera-shake.

### 1 Press the ⚡ (Flash pop-up) button to pop up the flash.

- The flash does not pop up automatically.

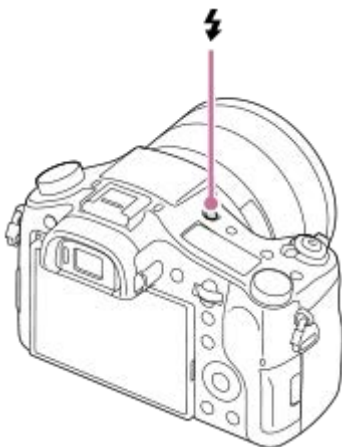

### 2 Press the shutter button fully down.

- The available flash modes depend on the shooting mode and function.

## When you do not use the flash

When not using the flash, press it back into the camera body.

### Note

- The light of the flash may be blocked if the lens hood is attached and the lower part of a recorded image may be shaded. Remove the lens hood.
- If you fire the flash before the flash unit pops up entirely, it may cause malfunction.
- You cannot use the flash when recording movies. (You can use an LED light when using a flash (sold separately) with an LED light.)
- When an external flash (sold separately) is attached to the Multi Interface Shoe, the state of the external flash has priority over the flash setting of this product. You cannot use the internal flash of this product.
- Before attaching/removing an accessory such as a flash to/from the Multi Interface Shoe, turn off the product first. When attaching an accessory, make sure that the accessory is fixed securely to the product.
- Do not use the Multi Interface Shoe with a commercially available flash that applies voltage of 250 V or more or has the reverse polarity of the camera. Doing so may cause a malfunction.
- When shooting with the flash and the zoom is set to W, the shadow of the lens may appear on the screen, depending on the shooting conditions. If this happens, shoot away from the subject or set the zoom to T and shoot with the flash again.
- When shooting with an external flash, light and dark stripes may appear on the image if the shutter speed is set to faster than 1/4000 seconds. If this occurs, Sony recommends shooting in the manual flash mode and setting the flash level to 1/2 or higher.
- For details on compatible accessories for the Multi Interface Shoe, visit the Sony website, or consult your Sony dealer or local authorized Sony service facility.

---

---

---

### Related Topic

- [Flash Mode](#)
- [Wireless flash shooting](#)

4-725-901-11(2) Copyright 2017 Sony Corporation



Digital Still Camera  
DSC-RX10M4

## Red Eye Reduction

---

When using the flash, it is fired two or more times before shooting to reduce the red-eye phenomenon.

**1** MENU →  (Camera Settings1) → [Red Eye Reduction] → desired setting.

### Menu item details

**On:**

The flash is always fired to reduce the red-eye phenomenon.

**Off:**

Does not use Red Eye Reduction.

**Note**

- Red Eye Reduction may not produce the desired effects. It depends on individual differences and conditions, such as distance to the subject, or whether the subject looks at the pre-strobe or not.

Digital Still Camera  
DSC-RX10M4

## Flash Mode

---

You can set the flash mode.

1 MENU →  1 (Camera Settings1) → [Flash Mode] → desired setting.

### Menu item details

#### Flash Off:

The flash does not operate.

#### Autoflash:

The flash works in dark environments or when shooting towards bright light.

#### Fill-flash:

The flash works every time you trigger the shutter.

#### Slow Sync.:

The flash works every time you trigger the shutter. Slow sync shooting allows you to shoot a clear image of both the subject and the background by slowing the shutter speed.

#### Rear Sync.:

The flash works right before the exposure is completed every time you trigger the shutter. Rear sync shooting allows you to shoot a natural image of the trail of a moving subject such as a moving car or a walking person.

#### Wireless:

Using a wireless flash creates a shading effect that gives the subject a more 3D appearance than when using the camera's flash.

This mode is effective when you attach a remote control-compatible external flash (sold separately) to the product, and shoot with a wireless flash (sold separately), placed away from the product.

#### Note

- The default setting depends on the shooting mode.
- Some [Flash Mode] settings are not available, depending on the shooting mode.
- The [Wireless] setting cannot be used with the camera's built-in flash.

---

### Related Topic

- [Using flash](#)
- [Wireless flash shooting](#)

Digital Still Camera  
DSC-RX10M4

## Flash Comp.

Adjusts the amount of flash light in a range of  $-3.0$  EV to  $+3.0$  EV. Flash compensation changes the amount of flash light only. Exposure compensation changes the amount of flash light along with the change of the shutter speed and aperture.

1 MENU →  1 (Camera Settings1) → [Flash Comp.] → desired setting.

- Selecting higher values (+ side) makes the flash level higher, and lower values (- side) makes the flash level lower.

### Note

- [Flash Comp.] does not work when the shooting mode is set to the following modes:
  - [Intelligent Auto]
  - [Superior Auto]
  - [Sweep Panorama]
  - [Scene Selection]
- The higher flash effect (+ side) may not be visible due to the limited amount of flash light available, if the subject is outside the maximum range of the flash. If the subject is very close, the lower flash effect (- side) may not be visible.

### Related Topic

- [Using flash](#)

Digital Still Camera  
DSC-RX10M4

## Wireless flash shooting

There are two methods for wireless flash shooting: light-signal flash shooting that uses the light of the flash attached to the camera as a signal light, and radio-signal flash shooting that uses wireless communication. To perform radio-signal flash shooting, use a compatible flash or the Wireless Radio Commander (sold separately). For details on how to set each method, refer to the instruction manual of the flash or the Wireless Radio Commander.

- 1 Remove the shoe cap from the camera, and then attach the flash or the Wireless Radio Commander.**
  - When performing wireless flash shooting with a flash attached, set the attached flash as the controller.
- 2 MENU →  1 (Camera Settings1) → [Flash Mode] → [Wireless].**
- 3 Set up an off-camera flash that is set to wireless mode, or that is attached to the Wireless Radio Receiver (sold separately).**
  - Press the AEL button on the camera to perform a test flashing.

### Setting of the AEL button

We recommend that you set MENU →  2 (Camera Settings2) → [Custom Key(Shoot.)] → [AEL Button] to [AEL hold] when performing wireless flash shooting.

#### Note

- The off-camera flash may emit light after receiving a light signal from a flash used as the controller of another camera. If this occurs, change the channel of your flash. For details on how to change the channel, refer to the instruction manual for the flash.
- For the flash that is compatible with wireless flash shooting, visit the Sony website, or consult your Sony dealer or local authorized Sony service facility.

Digital Still Camera  
DSC-RX10M4

## Shooting movies

You can record movies by pressing the MOVIE (Movie) button.

### 1 Press the MOVIE button to start recording.

- Since the [MOVIE Button] is set to [Always] in the default setting, movie recording can be started from any shooting mode.

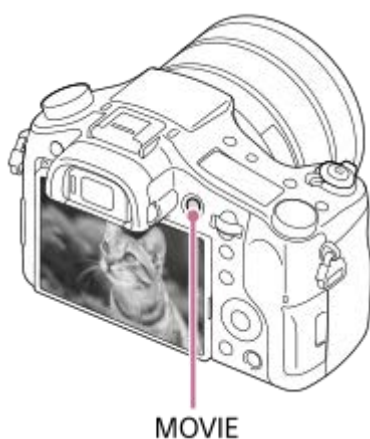



### 2 Press the MOVIE button again to stop recording.

#### Hint

- You can assign the start/stop movie recording function to a preferred key. MENU → (Camera Settings2) → [Custom Key(Shoot.)] → set the function to the preferred key.
- When you want to specify the area to be focused on, set the area using [Focus Area].
- To keep the focus on a face, arrange the composition so that the focusing frame and face detection frame overlap, or set the [Focus Area] to [Wide].
- To adjust the shutter speed and aperture value to the desired settings, set the shooting mode to (Movie) and select the desired exposure mode.
- The following settings for still image shooting are applied to the movie shooting:
  - White Balance
  - Creative Style
  - Metering Mode
  - Smile/Face Detect.
  - D-Range Opt.
- You can change the settings for ISO sensitivity, exposure compensation, and focus area while shooting movies.
- While shooting movies, the recorded image can be output without the shooting information display by setting [HDMI Info. Display] to [Off].

#### Note

- The sound of the lens and the product in operation may be recorded during movie recording. The sound of the zoom is particularly likely to be recorded during movie recording if [Zoom Speed] is set to [Fast] or [Zoom Func. on Ring] is set to [Quick]. You can turn the sound off by selecting MENU → (Camera Settings2) → [Audio Recording] → [Off].

- When shooting, the sound of the shoulder strap hooks (triangular hook) could be recorded, depending on the situation used.
- The temperature of the camera tends to rise when shooting movies continuously, and you may feel that the camera is warm. This is not a malfunction. Also, [Internal temp. high. Allow it to cool.] may appear. In such cases, turn the camera off and wait until the camera is ready to shoot again.
- If the  icon appears, the temperature of the camera has risen.
- For the continuous shooting time of a movie recording, refer to “Recordable movie times.” When movie recording is finished, you can restart recording by pressing the MOVIE button again. Recording may stop to protect the product, depending on the temperature of the product or the battery.
- When the mode dial is set to  (Movie) or when shooting movies, you cannot select [Lock-on AF] for [Focus Area].
- In [Program Auto] mode when shooting movies, the aperture value and the shutter speed will be set automatically and cannot be changed. For that reason, the shutter speed may become fast in a bright environment, and the motion of the subject may not record smoothly. By changing the exposure mode and adjusting the aperture value and the shutter speed, the motion of the subject can be recorded smoothly.
- In movie shooting mode, ISO sensitivity can be selected from ISO 100 to ISO 12800. If the ISO value is set to a value smaller than ISO 100, the setting is automatically switched to ISO 100. When you finish recording the movie, the ISO value returns to the original setting.
- When ISO sensitivity is set to [Multi Frame NR], [ISO AUTO] will be set temporarily.
- In movie shooting mode, the following settings cannot be set in [Picture Effect]. When a movie recording starts, [Off] will be set temporarily.
  - Soft Focus
  - HDR Painting
  - Rich-tone Mono.
  - Miniature
  - Watercolor
  - Illustration
- If you point the camera at an extremely strong light source while shooting a movie at low ISO sensitivity, the highlighted area in the image may be recorded as a black area.
- If the display mode of the monitor is set to [For viewfinder], the display mode will switch to [Display All Info.] when movie shooting starts.
- Use PlayMemories Home when importing XAVC S movies and AVCHD movies to a computer.

---

## Related Topic

- [MOVIE Button](#)
- [Movie w/ shutter](#)
- [File Format \(movie\)](#)
- [Recordable movie times](#)
- [Custom Key\(Shoot.\)/Custom Key\(PB\)](#)
- [Focus Area](#)

Digital Still Camera  
DSC-RX10M4

## Movie w/ shutter

---

You can start or stop recording movies by pressing the shutter button, which is bigger and easier to press than the MOVIE (Movie) button.

1 MENU →  2 (Camera Settings2) → [Movie w/ shutter] → desired setting.

### Menu item details

**On:**  
Enables movie recording using the shutter button when the shooting mode is set to [Movie] or during High Frame Rate shooting.

**Off:**  
Disables movie recording using the shutter button.

#### Hint

- When [Movie w/ shutter] is set to [On], you can still start or stop recording movies using the MOVIE button.
- When [Movie w/ shutter] is set to [On], you can use the shutter button to start or stop recording movies on an external recording/playback device using [ REC Control].

---

### Related Topic

- [Shooting movies](#)

Digital Still Camera  
DSC-RX10M4

## Movie recording formats

---

The following movie recording formats are available with this camera.

### What is XAVC S?

Records movies in high definition such as 4K by converting them into MP4 movies using the MPEG-4 AVC/H.264 codec. MPEG-4 AVC/H.264 is capable of compressing images with higher efficiency. You can record high-quality images while reducing the amount of data.

### XAVC S/AVCHD recording format

#### XAVC S 4K:

Bit-rate: Approx. 100 Mbps or approx. 60 Mbps

Records movies in 4K resolution (3840×2160).

#### XAVC S HD:

Bit-rate: Approx. 100 Mbps, approx. 60 Mbps, approx. 50 Mbps, approx. 25 Mbps, or approx. 16 Mbps

Records movies in crisper quality than AVCHD with larger amounts of data.

#### AVCHD:

Bit-rate: Approx. 24 Mbps (maximum) or approx. 17 Mbps (average)

The AVCHD format has a high degree of compatibility with storage devices other than computers.

- Bit rate is the amount of data processed within a given period of time.

---

### Related Topic



- [File Format \(movie\)](#)
- [Record Setting \(movie\)](#)
- [AVCHD format](#)



Digital Still Camera  
DSC-RX10M4

## File Format (movie)



Selects the movie file format.

1 MENU →  2 (Camera Settings2) → [ File Format] → desired setting.

### Menu item details

 File Format	Characteristics	
XAVC S 4K	Records movies in 4K resolution (3840×2160).	You can save movies on a computer using the PlayMemories Home software.
XAVC S HD	Records movies in crisper quality than AVCHD with larger amounts of data.	You can save movies on a computer using the PlayMemories Home software.
AVCHD	The AVCHD format has a high degree of compatibility with storage devices other than computers.	You can save movies on a computer or create a disc that supports this format using the PlayMemories Home software.



#### Note

- When [ File Format] is set to [AVCHD], the file size of movies is limited to approx. 2 GB. If the movie file size reaches approx. 2 GB during recording, a new movie file will be created automatically.
- If you set [ File Format] to [XAVC S 4K] and shoot movies while the camera is connected to an HDMI device, images will not be displayed on the monitor.

Digital Still Camera  
DSC-RX10M4

## Record Setting (movie)

Selects the frame rate and bit-rate for movie recording.

1 MENU →  2 (Camera Settings2) → [ Record Setting] → desired setting.

- The higher the bit-rate, the higher the image quality.

### Menu item details

When [ File Format] is set to [XAVC S 4K]

 Record Setting	Bit-rate	Description
30p 100M/25p 100M	Approx. 100 Mbps	Records movies in 3840×2160 (30p/25p).
30p 60M/25p 60M	Approx. 60 Mbps	Records movies in 3840×2160 (30p/25p).
24p 100M*	Approx. 100 Mbps	Records movies in 3840×2160 (24p).
24p 60M*	Approx. 60 Mbps	Records movies in 3840×2160 (24p).

\* Only when [NTSC/PAL Selector] is set to NTSC

When [ File Format] is set to [XAVC S HD]

 Record Setting	Bit-rate	Description
60p 50M/50p 50M	Approx. 50 Mbps	Records movies in 1920×1080 (60p/50p).
60p 25M/50p 25M	Approx. 25 Mbps	Records movies in 1920×1080 (60p/50p).
30p 50M/25p 50M	Approx. 50 Mbps	Records movies in 1920×1080 (30p/25p).
30p 16M/25p 16M	Approx. 16 Mbps	Records movies in 1920×1080 (30p/25p).
24p 50M*	Approx. 50 Mbps	Records movies in 1920×1080 (24p).
120p 100M/100p 100M	Approx. 100 Mbps	Records high-speed movies in 1920×1080 (120p/100p). You can record movies in 120 fps or 100 fps. <ul style="list-style-type: none"> <li>• You can create smoother slow-motion movies by using compatible editing devices.</li> </ul>

 Record Setting	Bit-rate	Description
120p 60M/100p 60M	Approx. 60 Mbps	Records high-speed movies in 1920×1080 (120p/100p). You can record movies in 120 fps or 100 fps. <ul style="list-style-type: none"> <li>You can create smoother slow-motion movies by using compatible editing devices.</li> </ul>

\* Only when [NTSC/PAL Selector] is set to NTSC

### When [ File Format] is set to [AVCHD]

 Record Setting	Bit-rate	Description
60i 24M(FX)/50i 24M(FX)	24 Mbps at maximum	Records movies in 1920×1080 (60i/50i).
60i 17M(FH)/50i 17M(FH)	Approx. 17 Mbps on average	Records movies in 1920×1080 (60i/50i).

#### Note

- Movies recorded with the [60i 24M(FX)]/[50i 24M(FX)] as the [ Record Setting] are converted by PlayMemories Home in order to create an AVCHD recording disc. You cannot create a disc in the original image quality. This conversion can take a long time. If you want to keep the original image quality, store your movies on a Blu-ray Disc.
- [120p]/[100p] cannot be selected for the following settings.
  - [Intelligent Auto]
  - [Superior Auto]
  - [Scene Selection]

#### Related Topic

- [Shooting super-slow-motion movies \(HFR Settings\)](#)

## Shooting super-slow-motion movies (HFR Settings)

By shooting with a higher frame rate than the recording format, you can record a smooth super-slow-motion movie.

### 1 Set the mode dial to **HFR** (High Frame Rate).

The shooting setting screen will be displayed.

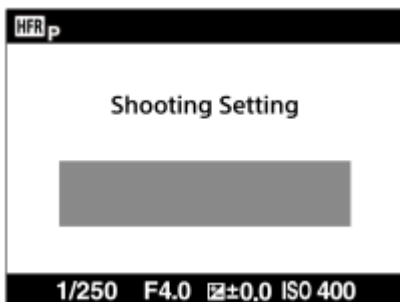

### 2 MENU → (Camera Settings2) → [**HFR** HFR Settings] and select the desired settings for [**HFR** Record Setting], [**HFR** Frame Rate], [**HFR** Priority Setting], and [**HFR** REC Timing].

- You can adjust the desired exposure mode by selecting MENU →  (Camera Settings2) → [**HFR** Exposure Mode].

### 3 Point the camera at the subject and adjust settings such as the focus.

- You can also change other settings, such as focus mode, ISO sensitivity, etc.

### 4 Press the center of the control wheel.

The shooting standby screen will be displayed.

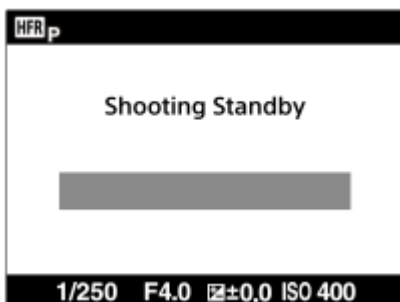

- During shooting standby, [Shooting Standby] is displayed in the center of the screen. You cannot adjust the exposure, adjust the focus, operate the zoom, etc. while [Shooting Standby] is displayed. If you want to change the shooting settings, press the center of the control wheel again to return to the shooting setting screen.

### 5 Press the **MOVIE** (Movie) button.

**When [**HFR** REC Timing] is set to [Start Trigger]:**

Movie capturing (shooting) starts. When the MOVIE button is pressed again, or when the recordable duration of time has elapsed, movie capturing ends and the camera starts to record the captured movie to the memory card.

**When [**HFR** REC Timing] is set to [End Trigger] or [End Trigger Half]:**

Movie capturing ends and the camera starts to record the captured movie to the memory card.

## Menu item details

### **HFR** Record Setting :

Selects the frame rate of the movie from [60p 50M]/[50p 50M], [30p 50M]/[25p 50M], and [24p 50M\*].

\* Only when [NTSC/PAL Selector] is set to NTSC.

### **HFR** Frame Rate :

Selects the shooting frame rate from [240fps]/[250fps], [480fps]/[500fps], and [960fps]/[1000fps].

### **HFR** Priority Setting :

Select from [Quality Priority] which prioritizes the image quality and [Shoot Time Priority] which prioritizes the duration of time of the movie.

### **HFR** REC Timing :

Selects whether to record for a set amount of time after you press the MOVIE button ([Start Trigger]), or for a set amount of time until you press the MOVIE button ([End Trigger]/[End Trigger Half]).

## Frame rate

In super-slow-motion movie shooting, the camera shoots at a faster shutter speed than the number of shooting frames per second. For example, when [**HFR** Frame Rate] is set to [960fps], the shutter speed per frame will be faster than approx. 1/1000 second in order to shoot 960 frames per second. To maintain this shutter speed, sufficient ambient light is necessary during shooting. If the ambient light is insufficient, the ISO sensitivity will become higher, resulting in more noise.

## Shortest shooting distance

- The image becomes out of focus when the subject is too close, such as during macro shooting. Shoot from the shortest shooting distance (from the front of the lens, approximately 3 cm (0.10 ft.) at the wide-angle end, approximately 72 cm (2.36 ft.) at the telephoto end, and approximately 140 cm (4.59 ft.) at a 35 mm-equivalent focal length of around 250 mm) or further.

## Timing of recording

Depending on the [**HFR** REC Timing] setting, the relationship between when you press the MOVIE button and the recorded section of the movie is as shown below.

### **[Start Trigger]**

Movie capturing (shooting) starts when the MOVIE button is pressed. When the MOVIE button is pressed again, or when the recordable duration of time has elapsed, movie capturing ends and the camera starts to record the captured movie to the memory card.

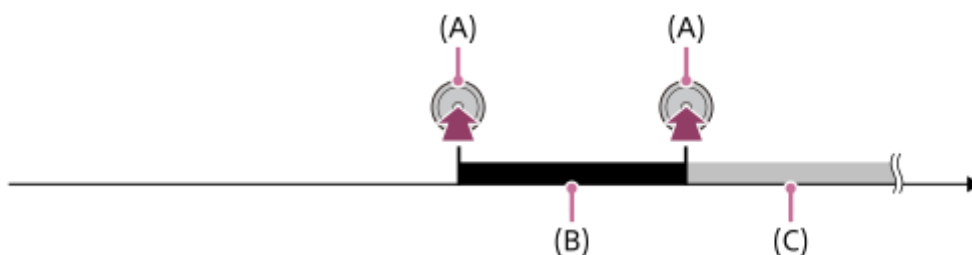

(A): The point when the MOVIE button is pressed

(B): Recorded section

(C): Recording to memory card in progress (You cannot start the next session of shooting.)

### **[End Trigger]/[End Trigger Half]**

Buffering (temporarily capturing a movie on the camera) starts once the shooting standby screen is displayed. When the captured data fills the buffering capacity, old data is overwritten sequentially. When you press the MOVIE button, the camera starts to record a movie of the set duration calculated retroactively from that point on the memory card.

- With [End Trigger], a movie of the maximum possible duration is recorded. With [End Trigger Half], a movie of half the maximum possible duration is recorded. With [End Trigger Half], the time it takes to record to the memory card is also shorter than with [End Trigger].

## End Trigger

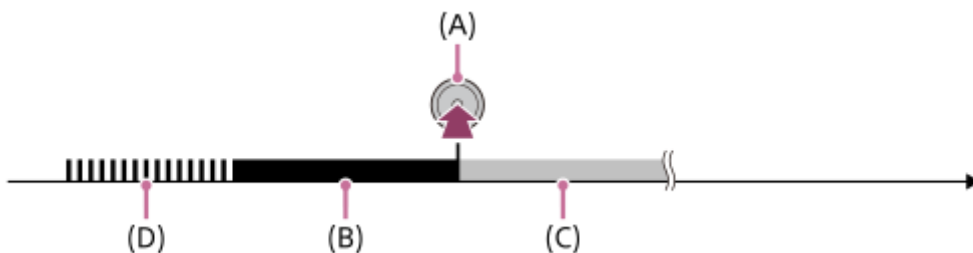

## End Trigger Half

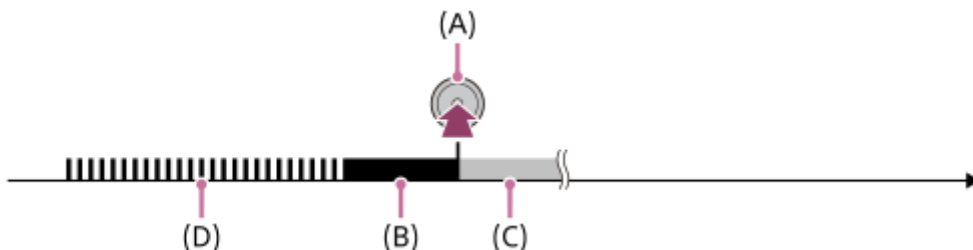

(A): The point when the MOVIE button is pressed

(B): Recorded section

(C): Recording to memory card in progress (You cannot start the next session of shooting.)

(D): Buffering in progress

## To redo shooting

You can cancel recording by selecting [Cancel] on the screen. However, the movie recorded up to the point you cancelled will be saved.

## Playback speed

The playback speed will vary as below depending on the assigned [**HFR** Frame Rate] and [**HFR** Record Setting].

<b>HFR</b> Frame Rate	<b>HFR</b> Record Setting		
	24p 50M*	30p 50M/25p 50M	60p 50M/50p 50M
240fps/250fps	10 times slower	8 times slower/10 times slower	4 times slower/5 times slower
480fps/500fps	20 times slower	16 times slower/20 times slower	8 times slower/10 times slower
960fps/1000fps	40 times slower	32 times slower/40 times slower	16 times slower/20 times slower

\* Only when [NTSC/PAL Selector] is set to NTSC.

## [**HFR** Priority Setting] and shooting duration

<b>HFR</b> Priority Setting	<b>HFR</b> Frame Rate	Effective pixel number read out from image sensor	Shooting duration
Quality Priority	240fps/250fps	1824×1026	Approx. 4 seconds
	480fps/500fps	1824×616	Approx. 3 seconds
	960fps/1000fps	1244×420	
Shoot Time Priority	240fps/250fps	1824×616	Approx. 7 seconds
	480fps/500fps	1292×436	Approx. 7 seconds/Approx. 6 seconds

HFR Priority Setting	HFR Frame Rate	Effective pixel number read out from image sensor	Shooting duration
	960fps/1000fps	912×308	Approx. 6 seconds

## Playback time

For example, if you shoot for approx. 4 seconds with [**HFR** Record Setting] set to [24p 50M]\*, [**HFR** Frame Rate] set to [960fps], and [**HFR** Priority Setting] set to [Shoot Time Priority], the playback speed will be 40 times slower and the playback time will be approx. 160 seconds (approx. 2 minutes and 40 seconds).

### Note

- Sound will not be recorded.
- The movie will be recorded in XAVC S HD format.
- It may take time for recording to finish after you press the MOVIE button. Wait until the screen switches to the shooting standby screen to start the next shooting.

## Related Topic

- [Movie recording formats](#)
- [Memory cards that can be used](#)
- [HFR \(High Frame Rate\): Exposure Mode](#)

## Capturing still images while recording movies (Dual Rec)

You can capture still images while recording movies without stopping recording. Use Dual Rec when you want to record both movies and still images at the same time.

- 1 Press the **MOVIE** button to start recording the movie.



- 2 Press the shutter button to capture a still image.

- If you press the shutter button halfway down, the remaining number of still images you can shoot will be displayed on the screen.
- While shooting still images, the message [CAPTURE] is displayed on the screen.

- 3 Press the **MOVIE** button again to finish recording the movie.

### Hint

- The image size or image quality of the still images can be selected from MENU →  2 (Camera Settings2) → [Img. Size(Dual Rec)]/[Quality(Dual Rec)].

### Note

- Dual Rec may be unavailable depending on the recording setting or mode setting.
- When [Px Proxy Recording] is set to [On], Dual Rec is unavailable.
- Depending on the memory card you use, it may take a while to record a still image.
- The shutter button sound may be recorded.
- You cannot use the flash while using Dual Rec.

### Related Topic

- [Quality\(Dual Rec\)](#)
- [Img. Size\(Dual Rec\)](#)
- [Auto Dual Rec](#)



- Shooting still images
- Shooting movies

4-725-901-11(2) Copyright 2017 Sony Corporation

Digital Still Camera  
DSC-RX10M4

## Quality(Dual Rec)

---

Selects the quality of still images to be shot while recording movies.

**1** MENU →  2 (Camera Settings2) → [Quality(Dual Rec)] → desired setting.

### Menu item details

Extra fine/Fine/Standard

Digital Still Camera  
DSC-RX10M4

## Img. Size(Dual Rec)

---

Selects the size of still images to be shot while recording movies.

**1** MENU →  **2** (Camera Settings2) → [Img. Size(Dual Rec)] → desired setting.



### Menu item details

L: 17M/M: 7.5M/S: 4.2M

Digital Still Camera  
DSC-RX10M4

## Auto Dual Rec

Sets whether or not to automatically shoot still images when shooting movies. Shoots when impressive compositions, including people, are detected. This function may also record versions of the automatically shot images that have been trimmed into optimal compositions. When a trimmed image is recorded, both the image before trimming and the trimmed image will be recorded.

- 1 MENU →  2 (Camera Settings2) → [Auto Dual Rec] → desired setting.
- 2 Press the **MOVIE** button to start movie recording.
  - Still images will be shot automatically. While capturing a still image, the message [CAPTURE] is displayed on the monitor.
- 3 Press the **MOVIE** button again to finish movie recording.
  - To view the movies and still images recorded, press the  (Playback) button.

### Menu item details

#### Off:

Auto Dual Rec is not performed.

#### On: Shoot. Frequency Low/On: Shoot. Frequency Standard/On: Shoot. Frequency High:

Auto Dual Rec is performed with the specified shooting frequency.

- The positions, orientation, expressions of faces are detected in order to shoot still images with the impressive compositions.

#### Hint

- If you want to change the size or quality of still images, use MENU →  2 (Camera Settings2) → [Img. Size(Dual Rec)]/[Quality(Dual Rec)].
- Even when [Auto Dual Rec] is set to On, you can record still images by pressing the shutter button.

#### Note

- Depending on the recording conditions, still images may not be shot with the optimal timing.



### Related Topic

- [Capturing still images while recording movies \(Dual Rec\)](#)
- [Auto Obj. Framing \(still image\)](#)

Digital Still Camera  
DSC-RX10M4

## Proxy Recording

Sets whether to simultaneously record low-bit-rate proxy movies when recording XAVC S movies. Since proxy movies are small in file size, they are suitable for transferring to smartphones or uploading to websites.

1 MENU →  2 (Camera Settings2) → [ Proxy Recording] → desired setting.

### Menu item details

#### On :

Proxy movies are simultaneously recorded.





#### Off :

Proxy movies are not recorded.

#### Hint

- Proxy movies are recorded in the XAVC S HD format (1280×720) at 9 Mbps. The frame rate of the proxy movie is the same as that of the original movie.
- Proxy movies are not displayed on the playback screen (single-image playback screen or image index screen).  is displayed over movies for which a proxy movie was simultaneously recorded.

#### Note

- Proxy movies cannot be played back on this camera.
- Proxy recording is not available in the following situations.
  - When [ File Format] is set to [AVCHD]
  - When [ File Format] is set to [XAVC S HD] and [ Record Setting] is set to [120p]/[100p]
  - When [ SteadyShot] is set to [Intelligent Active]
- Deleting/protecting movies that have proxy movies removes/protects both the original and proxy movies. You cannot delete/protect only original movies or proxy movies.
- Movies cannot be edited on this camera.

### Related Topic

- [Snd to Smrtphn Func: Sending Target \(proxy movies\)](#)
- [Movie recording formats](#)
- [Playing back images on the image index screen \(Image Index\)](#)
- [Memory cards that can be used](#)

Digital Still Camera  
DSC-RX10M4

## Audio Recording

---

Sets whether to record sounds when shooting movies. Select [Off] to avoid recording the sounds of the lens and the camera operating.

**1** MENU →  **2** (Camera Settings2) → [Audio Recording] → desired setting.

### Menu item details

**On:**

Records sound (stereo).

**Off:**

Does not record sound.

Digital Still Camera  
DSC-RX10M4

## Audio Level Display

---

Sets whether to display the audio level on the screen.

1 MENU →  2 (Camera Settings2) → [Audio Level Display] → desired setting.

### Menu item details

**On:**

Displays the audio level.

**Off:**

Does not display the audio level.

**Note**

- The audio level is not displayed in the following situations:
  - When [Audio Recording] is set to [Off].
  - When DISP (Display Setting) is set to [No Disp. Info.].
  - During High Frame Rate shooting
- The audio level is also displayed while shooting stand-by in movie recording mode.

Digital Still Camera  
DSC-RX10M4

## Audio Rec Level

---

You can adjust the audio recording level while checking the level meter.

- 1 MENU →  2 (Camera Settings2) → [Audio Rec Level].
- 2 Select the desired level using the right/left sides of the control wheel.

### Menu item details

+:

Turns up the audio recording level.

-:

Turns down the audio recording level.

**Reset:**

Resets the audio recording level to the default setting.

#### Hint

- When you record audio movies with loud volumes, set [Audio Rec Level] to a lower sound level. Doing so enables you to record more realistic audio. When you record audio movies with lower volumes, set [Audio Rec Level] to a greater sound level to make the sound easier to hear.

#### Note

- Regardless of the [Audio Rec Level] settings, the limiter always operates.
- [Audio Rec Level] is available only when the shooting mode is set to movie mode.
- [Audio Rec Level] is unavailable during High Frame Rate shooting.
- The [Audio Rec Level] settings are applied for both the internal microphone and the  (microphone) terminal input.



Digital Still Camera  
DSC-RX10M4

## Audio Out Timing

---

You can set echo cancellation during audio monitoring and prevent undesirable deviations between video and audio during HDMI output.

**1** MENU →  **2** (Camera Settings2) → [Audio Out Timing] → desired setting.

### Menu item details

**Live:**

Outputs audio without delay. Select this setting when audio deviation is a problem during audio monitoring.

**Lip Sync:**

Outputs audio and video in sync. Select this setting to prevent undesirable deviations between video and audio.

Digital Still Camera  
DSC-RX10M4

## Wind Noise Reduct.

---

Sets whether or not to reduce wind noise by cutting the low-range sound of the input audio from the built-in microphone.

**1** MENU →  2 (Camera Settings2) → [Wind Noise Reduct.] → desired setting.

### Menu item details

**On:**

Reduces wind noise.

**Off:**

Does not reduce wind noise.

**Note**

- Setting this item to [On] where wind is not blowing sufficiently hard may cause normal sound to be recorded with too low volume.
- When an external microphone (sold separately) is used, [Wind Noise Reduct.] does not function.

Digital Still Camera  
DSC-RX10M4

## Picture Profile

Allows you to change the settings for the color, gradation, etc. For details on "Picture Profile," refer to <http://helpguide.sony.net/di/pp/v1/en/index.html>.

### Customizing the picture profile

You can customize the picture quality by adjusting picture profile items such as [Gamma] and [Detail]. When setting these parameters, connect the camera to a TV or monitor, and adjust them while observing the picture on the screen.

- 1 MENU →  1 (Camera Settings1) → [Picture Profile] → the profile you want to change.
- 2 Move to the item index screen by pressing the right side of the control wheel.
- 3 Select the item to change using the top/bottom sides of the control wheel.
- 4 Select the desired value using the top/bottom sides of the control wheel and press in the center.

### Using the preset of the picture profile

The default settings [PP1] through [PP9] for movies have been set in advance in the camera based on various shooting conditions.

MENU →  1 (Camera Settings1) → [Picture Profile] → desired setting.

#### PP1:

Example setting using [Movie] gamma

#### PP2:

Example setting using [Still] gamma

#### PP3:

Example setting of natural color tone using the [ITU709] gamma

#### PP4:

Example setting of a color tone faithful to the ITU709 standard

#### PP5:

Example setting using [Cine1] gamma

#### PP6:

Example setting using [Cine2] gamma

#### PP7:

Example setting using [S-Log2] gamma

#### PP8:

Example setting using the [S-Log3] gamma and the [S-Gamut3.Cine] under [Color Mode].

#### PP9:

Example setting using the [S-Log3] gamma and the [S-Gamut3] under [Color Mode].

### Items of the picture profile

#### Black Level

Sets the black level. (-15 to +15)

#### Gamma

Selects a gamma curve.

Movie: Standard gamma curve for movies

Still: Standard gamma curve for still images

Cine1: Softens the contrast in dark parts and emphasizes gradation in bright parts to produce a relaxed color movie. (equivalent to HG4609G33)

Cine2: Similar to [Cine1] but optimized for editing with up to 100% video signal. (equivalent to HG4600G30)

ITU709: Gamma curve that corresponds to ITU709.

ITU709(800%): Gamma curve for confirming scenes on the assumption of shooting using [S-Log2] or [S-Log3].

S-Log2: Gamma curve for [S-Log2]. This setting is based on the assumption that the picture will be processed after shooting.

S-Log3: Gamma curve for [S-Log3] with more similar features to film. This setting is based on the assumption that the picture will be processed after shooting.

### Black Gamma

Corrects gamma in low intensity areas.

Range: Selects the correcting range. (Wide / Middle / Narrow)

Level: Sets the correcting level. (-7 (maximum black compression) to +7 (maximum black stretch))

### Knee

Sets knee point and slope for video signal compression to prevent over-exposure by limiting signals in high intensity areas of the subject to the dynamic range of your camera.

When [Still], [Cine1], [Cine2], [ITU709(800%)], [S-Log2], or [S-Log3] is selected in [Gamma], [Knee] becomes unavailable if [Mode] is set to [Auto]. To use the functions in [Knee], set [Mode] to [Manual].

Mode: Selects auto/manual settings.

- Auto: The knee point and slope are set automatically.
- Manual: The knee point and slope are set manually.

Auto Set: Settings when [Auto] is selected for [Mode].

- Max Point: Sets the maximum point of the knee point. (90% to 100%)
- Sensitivity: Sets the sensitivity. (High / Mid / Low)

Manual Set: Settings when [Manual] is selected for [Mode].

- Point: Sets the knee point. (75% to 105%)
- Slope: Sets the knee slope. (-5 (gentle) to +5 (steep))

### Color Mode

Sets type and level of colors.

Movie: Suitable colors when [Gamma] is set to [Movie].

Still: Suitable colors when [Gamma] is set to [Still].

Cinema: Suitable colors when [Gamma] is set to [Cine1].

Pro: Similar color tones to the standard image quality of Sony professional cameras (when combined with ITU709 gamma)

ITU709 Matrix: Colors corresponding to ITU709 standard (when combined with ITU709 gamma)

Black & White: Sets the saturation to zero for shooting in black and white.

S-Gamut: Setting based on the assumption that the pictures will be processed after shooting. Used when [Gamma] is set to [S-Log2].

S-Gamut3.Cine: Setting based on the assumption that the pictures will be processed after shooting. Used when [Gamma] is set to [S-Log3]. This setting allows you to shoot in a color space that can easily be converted for digital cinema.

S-Gamut3: Setting based on the assumption that the pictures will be processed after shooting. Used when [Gamma] is set to [S-Log3]. This setting allows you to shoot in a wide color space.

### Saturation

Sets the color saturation. (-32 to +32)

## Color Phase

Sets the color phase. (-7 to +7)

## Color Depth

Sets the color depth for each color phase. This function is more effective for chromatic colors and less effective for achromatic colors. The color looks deeper as you increase the setting value towards the positive side, and lighter as you decrease the value towards the negative side. This function is effective even if you set [Color Mode] to [Black & White].

[R] -7 (light red) to +7 (deep red)

[G] -7 (light green) to +7 (deep green)

[B] -7 (light blue) to +7 (deep blue)

[C] -7 (light cyan) to +7 (deep cyan)

[M] -7 (light magenta) to +7 (deep magenta)

[Y] -7 (light yellow) to +7 (deep yellow)

## Detail

Sets items for [Detail].

Level: Sets the [Detail] level. (-7 to +7)

Adjust: The following parameters can be selected manually.

- Mode: Selects auto/manual setting. (Auto (automatic optimization) / Manual (The details are set manually.))
- V/H Balance: Sets the vertical (V) and horizontal (H) balance of DETAIL. (-2 (off to the vertical (V) side) to +2 (off to the horizontal (H) side))
- B/W Balance: Selects the balance of the lower DETAIL (B) and the upper DETAIL (W). (Type1 (off to the lower DETAIL (B) side) to Type5 (off to the upper DETAIL (W) side))
- Limit: Sets the limit level of [Detail]. (0 (Low limit level: likely to be limited) to 7 (High limit level: unlikely to be limited))
- Crisping: Sets the crisping level. (0 (shallow crisping level) to 7 (deep crisping level))
- Hi-Light Detail: Sets the [Detail] level in the high intensity areas. (0 to 4)

## To copy the settings to another picture profile number

You can copy the settings of the picture profile to another picture profile number.

MENU →  1 (Camera Settings1) → [Picture Profile] → [Copy].

## To Reset the picture profile to the default setting

You can reset the picture profile to the default setting. You cannot reset all picture profile settings at once.

MENU →  1 (Camera Settings1) → [Picture Profile] → [Reset].

### Note

- Since the parameters are shared for movie and still images, adjust the value when you change the shooting mode.
- If you print RAW images with shooting settings, the following settings are not reflected:
  - Black Level
  - Black Gamma
  - Knee
  - Color Depth
- When the  Record Setting] is [120p 100M]/[100p 100M] or [120p 60M]/[100p 60M], [Black Gamma] is fixed at “0” and cannot be adjusted.
- If you change [Gamma], the available ISO value range changes.
- When using S-Log2 or S-Log3 gamma, the noise becomes more noticeable compared to when using other gammas. If the noise still is significant even after processing pictures, it may be improved by shooting with a brighter setting. However, the dynamic range becomes narrower accordingly when you shoot with a brighter setting. We recommend checking the picture in advance by test shooting when using S-Log2 or S-Log3.
- Setting [ITU709(800%)], [S-Log2] or [S-Log3] may cause an error in the white balance custom setup. In this case, perform custom setup with a gamma other than [ITU709(800%)], [S-Log2], or [S-Log3] first, and then reselect [ITU709(800%)], [S-Log2], or [S-Log3] gamma.
- Setting [ITU709(800%)], [S-Log2] or [S-Log3] disables the [Black Level] setting.
- If you set [Slope] to +5 in [Manual Set], [Knee] is set to [Off].

- S-Gamut, S-Gamut3.Cine, and S-Gamut3 are color spaces exclusive to Sony. However, this camera's S-Gamut setting does not support the whole S-Gamut color space; it is a setting to achieve a color reproduction equivalent to S-Gamut.

---

---

### Related Topic

- [Gamma Disp. Assist](#)

4-725-901-11(2) Copyright 2017 Sony Corporation

Digital Still Camera  
DSC-RX10M4

## Gamma Disp. Assist

Movies with S-Log gamma are assumed to be processed after shooting in order to make use of the wide dynamic range. They are therefore displayed in low contrast during shooting and may be difficult to monitor, using [Gamma Disp. Assist], contrast equivalent to that of normal gamma can be reproduced. In addition, [Gamma Disp. Assist] can also be applied when playing back movies on the camera's monitor/viewfinder.

- 1 MENU →  (Setup) → [Gamma Disp. Assist].
- 2 Select the desired setting using the top/bottom sides of the control wheel.

### Menu item details

Assist  
OFF **Off:**

Does not apply [Gamma Disp. Assist].

Assist  
AUTO **Auto:**

Displays movies with an [S-Log2→709(800%)] effect when the gamma set in [Picture Profile] is [S-Log2], and with an [S-Log3→709(800%)] effect when the gamma is set to [S-Log3].

Assist  
S-Log2 **S-Log2→709(800%):**

Displays movies with an S-Log2 gamma reproducing contrast equivalent to ITU709 (800%).

Assist  
S-Log3 **S-Log3→709(800%):**

Displays movies with an S-Log3 gamma reproducing contrast equivalent to ITU709 (800%).

#### Note

- When [Gamma Disp. Assist] is set to [Auto] during playback, the picture is displayed based on the current gamma setting in [Picture Profile] instead of auto-detecting the gamma value of the movie.
- [Gamma Disp. Assist] is not applied to movies when displayed on a TV or monitor connected to the camera.



### Related Topic

- [Picture Profile](#)

Digital Still Camera  
DSC-RX10M4

## Auto Slow Shut. (movie)

Sets whether or not to adjust the shutter speed automatically when recording movies if the subject is dark.

1 MENU →  2 (Camera Settings2) → [ Auto Slow Shut.] → desired setting.

### Menu item details



#### On:

Uses Auto Slow Shutter. The shutter speed automatically slows when recording in dark locations. You can reduce noise in the movie by using a slow shutter speed when recording in dark locations.

#### Off:

Does not use Auto Slow Shutter. The recorded movie will be darker than when [On] is selected, but you can record movies with smoother motion and less object blur.

#### Note

- [ Auto Slow Shut.] does not function in the following situations:
  - During High Frame Rate shooting
  -  S (Shutter Priority)
  -  M (Manual Exposure)
  - When [ISO] is set to other than [ISO AUTO]





Digital Still Camera  
DSC-RX10M4

## AF drive speed (movie)

---

You can switch focusing speed when using autofocus in movie mode.

1 MENU →  2 (Camera Settings2) →  AF drive speed] → desired setting.

### Menu item details

**Fast:**

Sets the AF drive speed to fast. This mode is suitable for shooting active scenes, such as sports.

**Normal:**

Sets the AF drive speed to normal.

**Slow:**

Sets the AF drive speed to slow. With this mode, the focus switches smoothly when the subject to be focused is changed.

**Note**



- When [ Record Setting] is set to [120p]/[100p], [ AF drive speed] cannot be used.

Digital Still Camera  
DSC-RX10M4

## AF Track Sens (movie)

---

You can set the AF sensitivity in movie mode.

1 MENU →  2 (Camera Settings2) →  AF Track Sens] → desired setting.

### Menu item details

#### Responsive:

Sets the AF sensitivity to high. This mode is useful when recording movies in which the subject is moving quickly.

#### Standard:



Sets the AF sensitivity to normal. This mode is useful when there are obstacles in front of the subject or in crowded places.



#### Note

- When  Record Setting] is set to [120p]/[100p],  AF Track Sens] cannot be used.

Digital Still Camera  
DSC-RX10M4

## SteadyShot (movie)

Sets [  SteadyShot] effect when shooting movies. If you set the [  SteadyShot] effect to [Off] when using a tripod (sold separately), a natural image is produced.

1 MENU →  2 (Camera Settings2) → [  SteadyShot] → desired setting.

### Menu item details

#### Intelligent Active:

Provides a more powerful SteadyShot effect than [Active].

#### Active:

Provides a more powerful SteadyShot effect.



#### Standard:

Reduces camera shake under stable movie shooting conditions.

#### Off:

Does not use [  SteadyShot].

#### Note

- If you change the setting for [  SteadyShot], the angle of view will change.
- [Intelligent Active] and [Active] cannot be selected when [  File Format] is set to [XAVC S 4K].

Digital Still Camera  
DSC-RX10M4

## TC/UB Settings

The time code (TC) and the user bit (UB) information can be recorded as data attached to movies.

- 1 MENU →  (Setup) → [TC/UB Settings] → setting value you want to change.

### Menu item details

#### TC/UB Disp. Setting:

Sets the display for the counter, time code, and user bit.

#### TC Preset:

Sets the time code.

#### UB Preset:

Sets the user bit.

#### TC Format:

Sets the recording method for the time code. (Only when [NTSC/PAL Selector] is set to NTSC.)

#### TC Run:

Sets the count up format for the time code.

#### TC Make:

Sets the recording format for the time code on the recording medium.



#### UB Time Rec:

Sets whether or not to record the time as a user bit.

### How to set the time code (TC Preset)

1. MENU →  (Setup) → [TC/UB Settings] → [TC Preset].
2. Turn the control wheel and select the first two digits.
  - The time code can be set between the following range.  
When [60i] is selected: 00:00:00:00 to 23:59:59:29
  - \* When [24p] is selected, you can select the last two digits of the time code in multiples of four from 0 to 23 frames.  
When [50i] is selected: 00:00:00:00 to 23:59:59:24
3. Set the other digits following the same procedure as in step 2, then press in the center of the control wheel.



### How to reset the time code

1. MENU →  (Setup) → [TC/UB Settings] → [TC Preset].
  2. Press the  (Delete) button to reset the time code (00:00:00:00).
- You can also reset the time code (00:00:00:00) using the RMT-VP1K remote commander (sold separately).

### How to set the user bit (UB Preset)

1. MENU →  (Setup) → [TC/UB Settings] → [UB Preset].
2. Turn the control wheel and select the first two digits.
3. Set the other digits following the same procedure as in step 2, then press in the center of the control wheel.

### How to reset the user bit

1. MENU →  (Setup) → [TC/UB Settings] → [UB Preset].
2. Press the  (Delete) button to reset the user bit (00 00 00 00).

### How to select the recording method for the time code (TC Format<sup>\*1</sup>)

1. MENU →  (Setup) → [TC/UB Settings] → [TC Format].

**DF:**

Records the time code in Drop Frame<sup>\*2</sup> format.

**NDF:**

Records the time code in Non-Drop Frame format.

\*1 Only when [NTSC/PAL Selector] is set to NTSC.

\*2 The time code is based on 30 frames per second. However, a gap between the actual time and the time code will occur during extended periods of recording as the frame frequency of the NTSC image signal is approximately 29.97 frames per second. Drop frame corrects this gap to make the time code and actual time equal. In drop frame, the first 2 frame numbers are removed every minute except for every tenth minute. The time code without this correction is called non-drop frame.

- The setting is fixed to [NDF] when recording in 4K/24p or 1080/24p.

**How to select the count up format for the time code (TC Run)**

1. MENU →  (Setup) → [TC/UB Settings] → [TC Run].

**Rec Run:**

Sets the stepping mode for the time code to advance only while recording. The time code is recorded sequentially from the last time code of the previous recording.

**Free Run:**

Sets the stepping mode for the time code to advance anytime, regardless of the camera operation.

- The time code may not be recorded sequentially in the following situations even when the time code advances in [Rec Run] mode.
  - When the recording format is changed.
  - When the recording medium is removed.

**How to select how the time code is recorded (TC Make)**

1. MENU →  (Setup) → [TC/UB Settings] → [TC Make].

**Preset:**

Records the newly set time code on the recording medium.

**Regenerate:**

Reads the last time code for the previous recording from the recording medium and records the new time code consecutively from the last time code. The time code advances in [Rec Run] mode regardless of the [TC Run] setting.

Digital Still Camera  
DSC-RX10M4

## TC/UB Disp. Switch

---

Allows you to display the time code (TC) and user bit (UB) of a movie by pressing the key to which [TC/UB Disp. Switch] function has been assigned.

- 1 MENU →  2 (Camera Settings2) → [Custom Key(Shoot.)]/[Custom Key(PB)] → assign the [TC/UB Disp. Switch] function to the desired key.
- 2 Press the key to which [TC/UB Disp. Switch] is assigned.
  - Each time you press the key, the monitor display will switch from the movie recording time counter → time code (TC) → user bit (UB), in that order.

Digital Still Camera  
DSC-RX10M4

## MOVIE Button

---

Sets whether or not to activate the MOVIE (Movie) button.

**1** MENU →  2 (Camera Settings2) → [MOVIE Button] → desired setting.

### Menu item details

**Always:**

Starts movie recording when you press the MOVIE button in any mode. (except when the mode dial is set to **HFR** (High Frame Rate).)



**Movie Mode Only:**

Starts movie recording when you press the MOVIE button only if the shooting mode is set to [ Movie] mode.

## Marker Display (movie)

---

Sets whether or not to display markers set using [  Marker Settings] on the monitor or the viewfinder while shooting movies.

1 MENU →  (Camera Settings2) → [  Marker Display] → desired setting.

### Menu item details

**On:**

Markers are displayed. The markers are not recorded.

**Off:**

No marker is displayed.

**Note**

- The markers are displayed when the mode dial is set to  ( Movie) or when shooting movies.
- You cannot display markers when using [Focus Magnifier].
- The markers are displayed on the monitor or viewfinder. (You cannot output the markers.)

---

### Related Topic

- [Marker Settings \(movie\)](#)





Digital Still Camera  
DSC-RX10M4

## Marker Settings (movie)

---

Sets the markers to be displayed while shooting movies.

1 MENU →  2 (Camera Settings2) → [ Marker Settings] → desired setting.

### Menu item details

**Center:**

Sets whether or not to display the center marker in the center of the shooting screen.

[Off]/[On]

**Aspect:**

Sets the aspect marker display.

[Off]/[4:3]/[13:9]/[14:9]/[15:9]/[1.66:1]/[1.85:1]/[2.35:1]

**Safety Zone:**

Sets the safety zone display. This becomes the standard range that can be received by a general household TV.

[Off]/[80%]/[90%]

**Guideframe:**

Sets whether or not to display the guide frame. You can verify whether the subject is level or perpendicular to the ground.

[Off]/[On]



**Hint**

- You can display several markers at the same time.
- Place the subject on the cross point of the [Guideframe] to make a balanced composition.

Digital Still Camera  
DSC-RX10M4

## 4K Output Sel. (movie)

You can set how to record movies and perform HDMI output when your camera is connected to 4K-compatible external recording/playback devices, etc.

- 1 Turn the mode dial to  (movie).
- 2 Connect the camera to the desired device via an HDMI cable.
- 3 MENU →  (Setup) → [ 4K Output Sel.] → desired setting.

### Menu item details

#### Memory Card+HDMI:

Simultaneously outputs to the external recording/playback device and records on the camera's memory card.

#### HDMI Only(30p):

Outputs a 4K movie in 30p to the external recording/playback device without recording on the camera's memory card.

#### HDMI Only(24p):

Outputs a 4K movie in 24p to the external recording/playback device without recording on the camera's memory card.

#### HDMI Only(25p)\*:

Outputs a 4K movie in 25p to the external recording/playback device without recording on the camera's memory card.

\* Only when [NTSC/PAL Selector] is set to PAL.

### Note

- This item can be set only when the camera is in movie mode and connected to a 4K-compatible device.
- When [HDMI Only(30p)], [HDMI Only(24p)] or [HDMI Only(25p)] is set, [HDMI Info. Display] will temporarily be set to [Off].
- When [HDMI Only(30p)], [HDMI Only(24p)] or [HDMI Only(25p)] is set, the counter does not move forward (the actual recording time is not counted) while the movie is being recorded on an external recording/playback device.
- When [ File Format] is set to [XAVC S 4K] and the camera is connected via HDMI, the following functions are not available.
  - [Smile/Face Detect.]
  - [Center Lock-on AF]

### Related Topic

- [HDMI Settings: REC Control \(movie\)](#)
- [File Format \(movie\)](#)
- [Record Setting \(movie\)](#)
- [HDMI Settings: HDMI Info. Display](#)

Digital Still Camera  
DSC-RX10M4

## Video Light Mode

---

Sets the illumination setting for the HVL-LBPC LED light (sold separately).

**1** MENU →  2 (Camera Settings2) → [Video Light Mode] → desired setting.

### Menu item details

**Power Link:**

The video light turns on/off in sync with the ON/OFF operation of this camera.

**REC Link:**

The video light turns on/off in sync with movie recording start/stop.

**REC Link&STBY:**

The video light turns on when movie recording starts and dims when not recording (STBY).

**Auto:**

The video light automatically turns on when it is dark.

## Playing back still images

---

Plays back the recorded images.

- 1 Press the  (Playback) button to switch to the playback mode.
- 2 Select the image with the control wheel.
  - Continuously shot images are displayed as one group. To play back the images in the group, press the center of the control wheel.

### Hint

- The product creates an image database file on a memory card to record and play back images. An image that is not registered in the image database file may not be played back correctly. To play back images shot using other devices, register those images to the image database file using MENU →  (Setup) → [Recover Image DB].
- If you play back the images right after continuous shooting, the monitor may display an icon indicating that data is being written/the number of images left to write. During writing, some functions are not available.
- You can also enlarge an image by double-tapping the monitor. In addition, you can drag and move the magnified position on the monitor. Set [Touch Operation] to other than [Off] beforehand.

---

### Related Topic



- [Recover Image DB](#)

## Enlarging an image being played back (Enlarge Image)

Enlarges the image being played back. Use this function to check the focus of the image, etc.

- 1 Display the image you want to enlarge, and slide the W/T (zoom) lever to the T side.**
  - Slide the W/T (zoom) lever to the W side to adjust the zoom scale.
  - By rotating the control dial, you can switch to the previous or next image while keeping the same zoom scale.
  - The view will zoom in on the part of the image where the camera focused during shooting. If the focus location information cannot be obtained, the camera will zoom in on the center of the image.
- 2 Select the portion you want to enlarge by pressing the top/bottom/right/left sides of the control wheel.**
- 3 Press the MENU button or the center of the control wheel to exit the playback zoom.**

### Hint

- You can also enlarge an image being played back using MENU.
- You can change the initial magnification and initial position of enlarged images by selecting MENU →  (Playback) → [ Enlarge Init. Mag.] or [ Enlarge Initial Pos.].
- You can also enlarge an image by double-tapping the monitor. In addition, you can drag and move the magnified position on the monitor. Set [Touch Operation] to other than [Off] beforehand.

### Note

- You cannot enlarge movies.

### Related Topic

- [Touch Operation](#)
- [Enlarge Init. Mag.](#)
- [Enlarge Initial Pos.](#)

Digital Still Camera  
DSC-RX10M4

## Rotating recorded images automatically (Display Rotation)

---

Selects the orientation when playing back recorded images.

**1** MENU →  (Playback) → [Display Rotation] → desired setting.

### Menu item details

**Auto:**

When you rotate the camera, the displayed image rotates automatically by detecting the orientation of the camera.

**Manual:**

Images shot vertically are displayed vertically. If you have set the image orientation using the [Rotate] function, the image will be displayed accordingly.

**Off:**

Images are always displayed horizontally.

---

### Related Topic

- [Rotating an image \(Rotate\)](#)

Digital Still Camera  
DSC-RX10M4

## Rotating an image (Rotate)

---

Rotates a recorded still image counter-clockwise.

**1** Display the image to be rotated, then select **MENU** →  (Playback) → **[Rotate]**.

**2** Press the center of the control wheel.

The image is rotated counter-clockwise. The image rotates as you press the center.

If you rotate the image once, the image remains rotated even after the product is turned off.

### Note

- You cannot rotate the movies.
- You may not be able to rotate images shot using other products.
- When viewing rotated images on a computer, the images may be displayed in their original orientation depending on the software.

## Playing back panoramic images

The product automatically scrolls a panoramic image from end to end.

- 1 Press the  (Playback) button to switch to playback mode.
- 2 Select the panoramic image to be played back using the control wheel and press the center to start playback.



- To pause playback, press the center again.
- To scroll panoramic images manually, press the top/bottom/right/left during pause.
- To return to the display of the entire image, press the MENU button.

### Note

- Panoramic images shot using other products may be displayed in a different size from the actual size, or may not scroll correctly.



Digital Still Camera  
DSC-RX10M4

## Enlarge Init. Mag.

---

Sets the initial magnification scale when playing back enlarged images.

1 MENU →  (Playback) → [ Enlarge Init. Mag.] → **desired setting.**

### Menu item details

#### Standard. Mag.:

Displays an image with the standard magnification.

#### Previous Mag.:

Displays an image with the previous magnification. The previous magnification is stored even after exiting the playback zoom mode.

---

### Related Topic

- [Enlarging an image being played back \(Enlarge Image\)](#)
- [Enlarge Initial Pos.](#)

Digital Still Camera  
DSC-RX10M4

## Enlarge Initial Pos.

---

Sets the initial position when enlarging an image in playback.

**1** MENU →  (Playback) → [ Enlarge Initial Pos.] → desired setting.

### Menu item details

**Focused Position:**

Enlarges the image from the point of focus during shooting.

**Center:**

Enlarges the image from the center of the screen.

---

### Related Topic

- [Enlarging an image being played back \(Enlarge Image\)](#)
- [Enlarge Init. Mag.](#)

Digital Still Camera  
DSC-RX10M4















## Playing back movies

Plays back the recorded movies.

- 1 Press the  (playback) button to switch to playback mode.
- 2 Select the movie to be played back using the control wheel and press the center of the control wheel to start playback.

### Available operations during movie playback

You can perform slow playback and sound volume adjustment, etc. by pressing the down side of the control wheel.

-  : Playback
-  : Pause
-  : Fast-forward
-  : Fast-rewind
-  : Forward slow playback
-  : Reverse slow playback
-  : Next movie file
-  : Previous movie file
-  : Displays the next frame
-  : Displays the previous frame
-  : Motion Shot Video (Shows the tracking of a subject in motion.)
-  : Photo Capture
-  : Sound volume adjustment
-  : Closes the operation panel

#### Hint

- “Forward slow playback,” “Reverse slow playback,” “Displays the next frame” and “Displays the previous frame” are available during pause.
- Movie files recorded using other products may not be able to be playable on this camera.

#### Related Topic

- [Switching between still images and movies \(View Mode\)](#)
- [Motion Shot Video](#)



Digital Still Camera  
DSC-RX10M4

## Motion Shot Video

---

You can see the tracking of the subject's motion in high-speed, like a stroboscopic image.

**1** Press the bottom side of the control wheel during movie playback, then select .

- To exit [Motion Shot Video] playback, select .
- If you fail to make the trail, you can adjust the interval of the image tracking using .

### Hint

- You can also change the interval of the image tracking using MENU →  (Playback) → [Motion Interval ADJ].

### Note

- You cannot save the images made with [Motion Shot Video] as a movie file.
- If the motion of the subject is too slow or the subject does not move enough, the product may fail to create the image.

---

### Related Topic

- [Motion Interval ADJ](#)

Digital Still Camera  
DSC-RX10M4

## Motion Interval ADJ

---

You can adjust the interval of the tracking of the subject's motion.

**1** MENU →  (Playback) → [Motion Interval ADJ] → **desired setting.**

---

### Related Topic

- [Motion Shot Video](#)

Digital Still Camera  
DSC-RX10M4

## Volume Settings

---

Sets the sound volume for movie playback.

**1** MENU →  (Setup) → [Volume Settings] → desired setting.

### Adjusting the volume during playback



Press the bottom side of the control wheel while playing back movies to display the operation panel, then adjust the volume. You can adjust the volume while listening to the actual sound.

Digital Still Camera  
DSC-RX10M4

## Photo Capture

---

Captures a chosen scene in a movie to save as a still image. First shoot a movie, then pause the movie during playback to capture decisive moments that tend to be missed when shooting still images, and save them as still images.

- 1 **Display the movie that you want to capture as a still image.**
  - 2 **MENU →  (Playback) → [Photo Capture].**
  - 3 **Play back the movie and pause it.**
  - 4 **Find the desired scene using forward slow playback, reverse slow playback, displays the next frame, and displays the previous frame, and then stop the movie.**
  - 5 **Press  (Photo Capture) to capture the chosen scene.**  
The scene is saved as a still image.
- 

### Related Topic

- [Shooting movies](#)
- [Playing back movies](#)

Digital Still Camera  
DSC-RX10M4

## Playing back images on the image index screen (Image Index)

---

You can display multiple images at the same time in playback mode.

- 1 Slide the W/T (zoom) lever to the W side while the image is being played back.
- 2 Select the image by pressing the top/bottom/right/left sides of the control wheel or turning the control wheel.

### To change the number of images to be displayed

MENU →  (Playback) → [Image Index] → desired setting.

#### Menu item details

9 Images/25 Images

### To return to single-image playback

Select the desired image and press the center of the control wheel.

### To display a desired image quickly

Select the bar on the left of the image index screen using the control wheel, then press the top/bottom sides of the control wheel. While the bar is being selected, you can display the calendar screen or folder selection screen by pressing the center. In addition, you can switch View Mode by selecting an icon.

---

#### Related Topic

- [Switching between still images and movies \(View Mode\)](#)



Digital Still Camera  
DSC-RX10M4

## Switching between still images and movies (View Mode)

---

Sets the View Mode (image display method).

1 MENU →  (Playback) → [View Mode] → desired setting.

### Menu item details

 **Date View:**

Displays the images by date.

 **Folder View(Still):**

Displays only still images.

 **AVCHD AVCHD View:**

Displays only AVCHD-format movies.

 **XAVC S HD View:**

Displays only XAVC S HD-format movies.

 **XAVC S 4K View:**

Displays only XAVC S 4K-format movies.

Digital Still Camera  
DSC-RX10M4

## Disp Cont Shoot Grp

Sets whether to display continuously shot images as a group.

1 MENU →  (Playback) → [Disp Cont Shoot Grp] → desired setting.

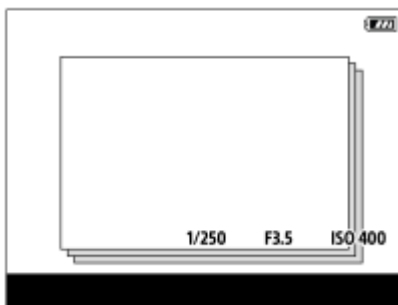

### Menu item details

#### On :

Displays continuously shot images as a group.

#### Off :

Does not display continuously shot images as a group.

#### Hint

- Images shot with [Drive Mode] set to [Cont. Shooting] are grouped. One sequence of images shot continuously by holding down the shutter button during continuous shooting becomes one group.
- On the image index screen,  is displayed over the continuous shooting group.

#### Note

- Images can be grouped and displayed only when [View Mode] is set to [Date View]. When it is not set to [Date View], images cannot be grouped and displayed, even if [Disp Cont Shoot Grp] is set to [On].
- If you delete the continuous shooting group, all the images in the group will be deleted.

### Related Topic

- [Cont. Shooting](#)

## Playing back images using slideshow (Slide Show)

---

Automatically plays back images continuously.

1 MENU →  (Playback) → [Slide Show] → desired setting.

2 Select [Enter].

### Menu item details

#### Repeat:

Select [On], in which images are played back in a continuous loop, or [Off], in which the product exits the slideshow when all the images are played back once.

#### Interval:

Select the display interval for images from among [1 Sec], [3 Sec], [5 Sec], [10 Sec] or [30 Sec].

### To quit the slideshow in the middle of playback

Press the MENU button to quit the slideshow. You cannot pause the slideshow.

#### Hint

- During playback, you can display the next/previous image by pressing the right/left side of the control wheel.
- You can activate a slideshow only when [View Mode] is set to [Date View] or [Folder View(Still)].

## Protecting images (Protect)



Protects recorded images against accidental erasure. The  mark is displayed on protected images.

1 MENU →  (Playback) → [Protect] → desired setting.

### Menu item details

#### Multiple Img.:

Applies or cancels the protection of the selected multiple images.

(1) Select the image to be protected, then press the center of the control wheel. The  mark is displayed in the check box. To cancel the selection, press the center again to remove the  mark.

(2) To protect other images, repeat step (1).

(3) MENU → [OK].

#### All in this Folder:

Protects all images in the selected folder.

#### All with this date:

Protects all images in the selected date range.

#### Cancel All in this Folder:

Cancels the protection of all images in the selected folder.

#### Cancel All with this date:

Cancels the protection of all images in the selected date range.

#### All in Cont. Shoot Grp:

Protects all the images in the selected continuous shooting group.

#### Cancel All in Cnt Sht Grp:

Cancels the protection of all the images in the selected continuous shooting group.

#### Hint

- If you select a continuous shooting group in [Multiple Img.], all the images in the group will be protected. To select and protect particular images within the group, execute [Multiple Img.] while displaying the images within the group.

#### Note

- The menu items that can be selected vary according to the [View Mode] setting and the selected content.

## Specifying images to be printed (Specify Printing)



You can specify in advance on the memory card which still images you want to print out later. The **DPOF** (print order) icon will appear on the specified images. DPOF refers to “Digital Print Order Format.” DPOF setting will be retained after the image is printed. We recommend that you cancel this setting after printing.

1 MENU →  (Playback) → [Specify Printing] → desired setting.

### Menu item details

#### Multiple Img.:

Selects images to order printing.

(1) Select an image and press the center of the control wheel. The  mark is displayed in the check box. To cancel the selection, press the center again and delete the  mark.

(2) Repeat step (1) to print other images. To select all the images from a certain date or in a certain folder, select the check box for the date or folder.

(3) MENU → [OK].

#### Cancel All:

Clears all DPOF marks.

#### Print Setting:

Sets whether to print the date on images registered with DPOF marks.

- The position or size of the date (inside or outside of the image) may differ depending on the printer.

#### Note

- You cannot add the DPOF mark to the following files:
  - RAW images
- The number of copies cannot be specified.
- Some printers do not support the date print function.

Digital Still Camera  
DSC-RX10M4

## Deleting a displayed image

---

You can delete an image displayed. Once you have deleted an image, you cannot restore it. Confirm the image to be deleted beforehand.

- 1 Display the image you want to delete.
- 2 Press the  (Delete) button.
- 3 Select [Delete] using the control wheel.

### Note

- The protected images cannot be deleted.

---

### Related Topic

- [Deleting multiple selected images \(Delete\)](#)

## Deleting multiple selected images (Delete)



You can delete multiple selected images. Once you have deleted an image, you cannot restore it. Confirm the image to be deleted beforehand.

- 1 MENU →  (Playback) → [Delete] → desired setting.

### Menu item details

#### Multiple Img.:

Deletes the selected images.

(1) Select the images to be deleted, then press the center of the control wheel. The  mark is displayed in the check box. To cancel the selection, press the center again to remove the  mark.

(2) To delete other images, repeat step (1).

(3) MENU → [OK].

#### All in this Folder:

Deletes all images in the selected folder.

#### All with this date:

Deletes all images in the selected date range.

#### All Other Than This Img.:

Deletes all images in the continuous shooting group except the selection.

#### All in Cont. Shoot Grp:

Deletes all images in the selected continuous shooting group.

#### Hint

- Perform [Format] to delete all images, including protected images.
- To display the desired folder or date, select the desired folder or date during playback by performing the following procedure:  
 (Image Index) button → select the bar on the left using the control wheel → select the desired folder or date using the top/bottom sides of the control wheel.
- If you select a continuous shooting group in [Multiple Img.], all the images in the group will be deleted. To select and delete particular images within the group, execute [Multiple Img.] while displaying the images within the group.

#### Note

- The protected images cannot be deleted.
- The menu items that can be selected vary according to the [View Mode] setting and the selected content.

### Related Topic

- [Deleting a displayed image](#)
- [Format](#)

Digital Still Camera  
DSC-RX10M4

## Delete confirm.

---

You can set whether [Delete] or [Cancel] is selected as a default on the delete confirmation screen.

**1** MENU →  (Setup) → [Delete confirm.] → desired setting.

### Menu item details

**"Delete" first:**

[Delete] is selected as the default setting.

**"Cancel" first:**

[Cancel] is selected as the default setting.



Digital Still Camera  
DSC-RX10M4

## Viewing images on a TV using an HDMI cable

To view images stored on this product using a TV, an HDMI cable (sold separately) and an HD TV equipped with an HDMI jack are required.

- 1 Turn off both this product and the TV.
- 2 Connect the HDMI micro terminal of this product to the HDMI jack of the TV using an HDMI cable (sold separately).

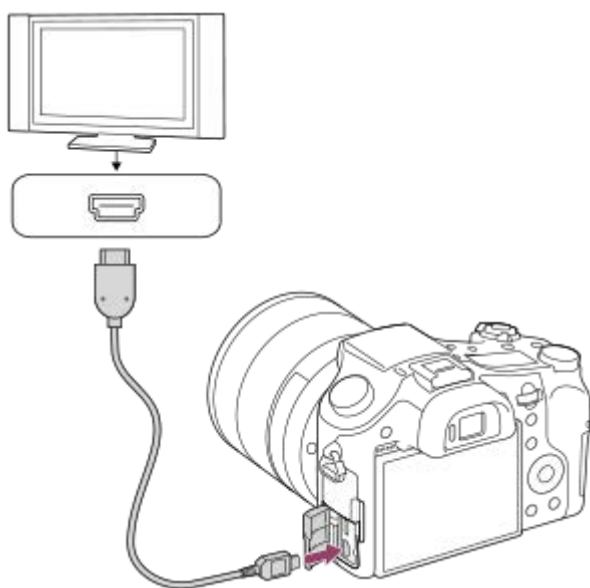



- 3 Turn on the TV and switch the input.
- 4 Turn on this product.  
Images shot with the product appear on the TV screen.
- 5 Select an image using the right/left sides of the control wheel.

- The monitor of this camera is not lit up on the playback screen.
- If the playback screen is not displayed, press the  (Playback) button.

### “BRAVIA” Sync

By connecting this product to a TV that supports “BRAVIA” Sync using an HDMI cable (sold separately), you can operate this product’s playback functions with the TV remote control.





1. After performing the steps above to connect this camera to a TV, select MENU →  (Setup) → [HDMI Settings] → [CTRL FOR HDMI] → [On].
2. Press the SYNC MENU button on the TV remote control, and select the desired mode.
  - If you connect this camera to a TV using an HDMI cable, available menu items are limited.
  - Only TVs that support “BRAVIA” Sync can provide SYNC MENU operations. For details, refer to the operating instructions supplied with the TV.

- If the product performs unwanted operations in response to the TV remote control when the product is connected to another manufacturer's TV using an HDMI connection, select MENU →  (Setup) → [HDMI Settings] → [CTRL FOR HDMI] → [Off].

### Hint

- This product is compatible with the PhotoTV HD standard. If you connect Sony PhotoTV HD-compatible devices using an HDMI cable (sold separately), the TV is set to the image quality suitable for viewing still images, and a whole new world of photos can be enjoyed in breathtaking high quality.
- You can connect this product to Sony PhotoTV HD-compatible devices with a USB terminal using the supplied micro USB cable.
- The PhotoTV HD allows for a highly-detailed, photo-like expression of subtle textures and colors.
- For details, refer to the operating instructions supplied with the compatible TV.



### Note

- Do not connect this product and another device using the output terminals of both. Doing so may cause a malfunction.
- Some devices may not work properly when connected to this product. For example, they may not output video or audio.
- Use an HDMI cable with the HDMI logo or a genuine Sony cable.
- Use an HDMI cable that is compatible with the HDMI micro terminal of the product and the HDMI jack of the TV.
- When [ TC Output] is set to [On], the image may not be output properly to the TV or recording device. In such cases, set [ TC Output] to [Off].
- If images do not appear on the TV screen properly, select MENU →  (Setup) → [HDMI Settings] → [HDMI Resolution] → [2160p/1080p], [1080p] or [1080i] according to the TV to be connected.
- During HDMI output, when you switch the movie from 4K to HD image quality or vice-versa, or change the movie to a different frame rate, the screen may become dark. This is not a malfunction.
- If you set [ File Format] to [XAVC S 4K] and shoot movies while the camera is connected to an HDMI device, images will not be displayed on the monitor.

Digital Still Camera  
DSC-RX10M4

## Memory (Camera Settings1/Camera Settings2)

Allows you to register up to 3 often-used modes or product settings to the product and up to 4 (M1 through M4) to the memory card. You can recall the settings using just the mode dial.

- 1 Set the product to the setting you want to register.
- 2 MENU →  1 (Camera Settings1) → [ 1 /  2 Memory] → desired number.
- 3 Press the center of the control wheel to confirm.

### Items that can be registered

- You can register various functions for shooting. The items that can actually be registered are displayed on the menu of the camera.
- Shutter speed
- Optical zoom scale

### To change registered settings

Change the setting to the desired one and re-register the setting to the same mode number.

#### Note



- M1 through M4 can be selected only when a memory card is inserted into the product.
- Program Shift cannot be registered.
- For some functions, the position of the dial and the setting actually used for shooting may not match. If this happens, shoot images by referring to the information displayed on the monitor.

### Related Topic

- [Recall \(Camera Settings1/Camera Settings2\)](#)

## Registering shooting settings to a custom key (Reg Cust Shoot Set)

You can register shooting settings (such as exposure, focus setting, drive mode, etc.) to a custom key in advance and temporarily recall them while holding down the key. Simply press the custom key to switch the settings quickly and release the key to go back to the original settings. This function is useful when recording active scenes such as sports.

- 1 **MENU** →  **1 (Camera Settings1)** → **[Reg Cust Shoot Set]** → **Select a registration number from [Recall Custom hold 1] to [Recall Custom hold 3].**  
 The setting screen for the selected number will be displayed.
- 2 **Using the top/bottom/left/right side of the control wheel, select the check boxes for the functions that you want to recall with one of the registration numbers and press the center to check each box.**  
 A  mark will be displayed in the boxes for the functions.
  - To cancel a selection, press the center again.
- 3 **Select the function that you want to adjust using the top/bottom/left/right side of the control wheel, and press the center to adjust the function to the desired setting.**
  - Select [Import Current Setting] to register the current settings of the camera to the registration number that you chose.
- 4 **Select [Register].**

### Items that can be registered

- You can register various functions for shooting. The items that can actually be registered are displayed on the menu of the camera.
- Exposure
- Focus setting
- Drive mode (other than self-timer)

### To recall registered settings

1. **MENU** →  **2 (Camera Settings2)** → **[Custom Key(Shoot.)]** → Select the desired key and then select one of the registration numbers from [Recall Custom hold 1] to [Recall Custom hold 3].
2. On the shooting screen, press the shutter button while holding down the key to which you assigned one of the registration numbers.  
 The registered settings are activated while you are holding down the custom key.

#### Hint

- You can change the settings for [Reg Cust Shoot Set] after assigning one of the registration numbers to the custom key using [Custom Key(Shoot.)].

#### Note

- The registration numbers [Recall Custom hold 1] through [Recall Custom hold 3] are available only when the shooting mode is set to P/A/S/M.
- Depending on the status of the camera when registered settings are recalled, the registered settings may not take effect.

---

---

## Related Topic

- [Custom Key\(Shoot.\)/Custom Key\(PB\)](#)

4-725-901-11(2) Copyright 2017 Sony Corporation

Digital Still Camera  
DSC-RX10M4

## Custom Key(Shoot.)/Custom Key(PB)

You can assign a desired function to a desired key.

Some functions are available only when they are assigned to a custom key. For example, if you assign [Eye AF] to [Center Button] for [Custom Key(Shoot.)], you can easily recall [Eye AF] simply by pressing the center of the control wheel while shooting.

- 1 MENU →  2 (Camera Settings2) → [Custom Key(Shoot.)] or [Custom Key(PB)].
- 2 Select the key to which you want to assign the function on the selection screen, and press the center of the control wheel.
  - The keys that can be assigned functions are different for [Custom Key(Shoot.)] and [Custom Key(PB)].
  - You can assign the desired functions to the following keys.

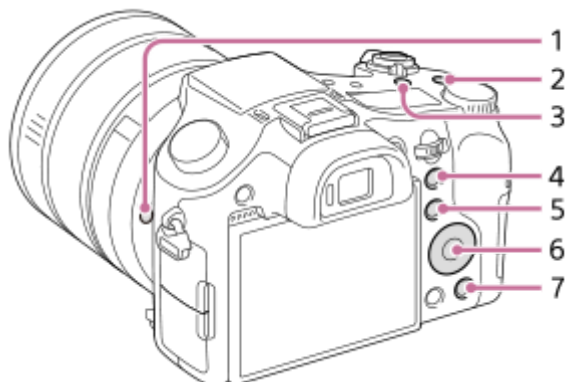

1. Focus Hold Button
2. Custom Button 1
3. Custom Button 2
4. AEL Button
5. Fn/  Button
6. Control Wheel/Center Button/Down Button/Left Button/Right Button
7. Custom Button 3

- 3 Select the function to be assigned.
  - The functions that can be assigned differ depending on the keys.

### Related Topic

- [Focus Standard](#)

Digital Still Camera  
DSC-RX10M4

## Function Menu Set.

---

You can assign the functions to be called up when you press the Fn (Function) button.

**1** MENU →  2 (Camera Settings2) → [Function Menu Set.] → set a function to the desired location.

- The functions that can be assigned are displayed on the setup item selection screen.

Digital Still Camera  
DSC-RX10M4

## Lens Ring Setup

You can zoom and focus more intuitively using the two lens rings (front and rear). Assigns the focus function or the zoom function to the front lens ring and rear lens ring.

1 MENU →  (Camera Settings2) → [Lens Ring Setup] → desired setting.

### Menu item details



 **Focus**  **Zoom:**

Assigns the focus function to the front lens ring and the zoom function to the rear lens ring.

 **Zoom**  **Focus:**

Assigns the zoom function to the front lens ring and the focus function to the rear lens ring.

#### Hint

- You can change which operation is associated with either rotational direction of the lens ring by selecting MENU →  (Camera Settings1) → [Focus Ring Rotate] or MENU →  (Camera Settings2) → [Zoom Ring Rotate].
- You can change the zoom function assigned to the lens ring by selecting MENU →  (Camera Settings2) → [Zoom Func. on Ring].

### Related Topic

- [Focus Ring Rotate](#)
- [Zoom Ring Rotate](#)
- [Zoom Func. on Ring](#)



Digital Still Camera  
DSC-RX10M4

## Dial / Wheel Lock

---

You can set whether the dial and wheel will be locked by pressing and holding the Fn (Function) button.

1 MENU →  2 (Camera Settings2) → [Dial / Wheel Lock] → desired setting.

### Menu item details

**Lock:**

Locks the control dial and control wheel.

**Unlock:**

Does not lock the control dial or control wheel even if you press and hold the Fn (Function) button.

**Hint**

- You can release the lock by holding the Fn (Function) button down again.

**Note**

- When [ AF Area Regist.] is set to [On], [Dial / Wheel Lock] is fixed to [Unlock].

## Add Item

---

You can register the desired menu items to ★ (My Menu) under MENU.

- 1 MENU → ★ (My Menu) → [Add Item].
- 2 Select an item that you want to add to ★ (My Menu) using the top/bottom/left/right sides of the control wheel.
- 3 Select a destination using the top/bottom/left/right sides of the control wheel.

### Hint

- You can add up to 30 items to ★ (My Menu).

### Note

- You cannot add the following items to ★ (My Menu).
  - Any item under MENU →  (Playback)
  - [View on TV]

---

### Related Topic

- [Sort Item](#)
- [Delete Item](#)
- [Using MENU items](#)

Digital Still Camera  
DSC-RX10M4

## Sort Item

---

You can rearrange the menu items added to ★ (My Menu) under MENU.

- 1 MENU → ★ (My Menu) → [Sort Item].
  - 2 Select an item that you want to move using the top/bottom/left/right sides of the control wheel.
  - 3 Select a destination using the top/bottom/left/right sides of the control wheel.
- 

### Related Topic

- [Add Item](#)

Digital Still Camera  
DSC-RX10M4

## Delete Item

---

You can delete menu items added to ★ (My Menu) of MENU.

1 MENU → ★ (My Menu) → [Delete Item].

2 Select an item that you want to delete using the top/bottom/left/right sides of the control wheel, and then press the center to delete the selected item.

### Hint

- To delete all the items on a page, select MENU → ★ (My Menu) → [Delete Page].
- You can delete all the items added to ★ (My Menu) by selecting MENU → ★ (My Menu) → [Delete All].

---

### Related Topic

- [Delete Page](#)
- [Delete All](#)
- [Add Item](#)

Digital Still Camera  
DSC-RX10M4

## Delete Page

---

You can delete all the menu items added to a page under ★ (My Menu) in MENU.

**1** MENU → ★ (My Menu) → [Delete Page].

**2** Select a page that you want to delete using the left/right sides of the control wheel, and then press the center of the control wheel to delete the items.

---

### Related Topic

- [Add Item](#)
- [Delete All](#)

Digital Still Camera  
DSC-RX10M4

## Delete All

---

You can delete all the menu items added to ★ (My Menu) in MENU.

- 1 MENU → ★ (My Menu) → [Delete All].
  - 2 Select [OK].
- 

### Related Topic

- [Add Item](#)
- [Delete Page](#)

Digital Still Camera  
DSC-RX10M4

## Auto Review

---

You can check the recorded image on the screen right after the shooting. You can also set the display time for Auto Review.

1 MENU →  2 (Camera Settings2) → [Auto Review] → desired setting.

### Menu item details

#### 10 Sec/5 Sec/2 Sec:

Displays the recorded image on the screen right after shooting for the selected duration of time. If you perform a magnifying operation during Auto Review, you can check that image using the magnified scale.

#### Off:

Does not display the Auto Review.

#### Note

- When you use a function that performs image processing, the image before processing may be displayed temporarily, followed by the image after processing.
- The DISP (Display Setting) settings are applied for the Auto Review display.

---

### Related Topic

- [Enlarging an image being played back \(Enlarge Image\)](#)

Digital Still Camera  
DSC-RX10M4

## Live View Display

Sets whether or not to show images altered with effects of the exposure compensation, white balance, [Creative Style], or [Picture Effect] on the screen.

1 MENU →  2 (Camera Settings2) → [Live View Display] → desired setting.

### Menu item details

#### Setting Effect ON:

Displays Live View in conditions close to what your picture will look like as a result of applying all your settings. This setting is useful when you want to shoot pictures while checking the results of the shot on the Live View screen.

#### Setting Effect OFF:

Displays Live View without the effects of exposure compensation, white balance, [Creative Style], or [Picture Effect]. When this setting is used, you can easily check the image composition.

Live View is always displayed with the appropriate brightness even in [Manual Exposure] mode.

When [Setting Effect OFF] is selected, the **VIEW** icon is displayed on the Live View screen.

#### Hint

- When you use a third-party flash, such as a studio flash, Live View Display may be dark for some shutter speed settings. When [Live View Display] is set to [Setting Effect OFF], Live View Display will be displayed brightly, so that you can easily check the composition.

#### Note

- [Live View Display] cannot be set to [Setting Effect OFF] in the following shooting modes:
  - [Intelligent Auto]
  - [Superior Auto]
  - [Sweep Panorama]
  - [Movie]
  - [High Frame Rate]
  - [Scene Selection]
- When [Live View Display] is set to [Setting Effect OFF], the brightness of the shot image will not be the same as that of the displayed Live View.



Digital Still Camera  
DSC-RX10M4

## Grid Line

---

Sets whether the grid line is displayed or not. The grid line will help you to adjust the composition of images.

**1** MENU →  2 (Camera Settings2) → [Grid Line] → **desired setting.**

### Menu item details

#### Rule of 3rds Grid:

Place main subjects close to one of the grid lines that divide the image into thirds for a well-balanced composition.

#### Square Grid:

Square grids make it easier to confirm the horizontal level of your composition. This is suitable to determine the quality of the composition when shooting landscape, close-up, or duplicated images.

#### Diag. + Square Grid:

Place a subject on the diagonal line to express an uplifting and powerful feeling.

#### Off:

Does not display the grid line.

Digital Still Camera  
DSC-RX10M4

## FINDER/MONITOR

---

Sets the method for switching the display between Electronic Viewfinder and the screen.

1 MENU →  2 (Camera Settings2) → [FINDER/MONITOR] → desired setting.

### Menu item details

#### Auto:

When you look into the Electronic Viewfinder, the eye sensor reacts and the display is switched to the Electronic Viewfinder automatically.

#### Viewfinder(Manual):

The screen is turned off and the image is displayed only in the Electronic Viewfinder.

#### Monitor(Manual):

The Electronic Viewfinder is turned off and the image is always displayed on the screen.

#### Hint

- You can assign the [FINDER/MONITOR] function to your preferred key.  
MENU →  2 (Camera Settings2) → [Custom Key(Shoot.)] → set [Finder/Monitor Sel.] to the preferred key.
- To turn off automatic switching of the display using the eye sensor, set [FINDER/MONITOR] to [Viewfinder(Manual)] or [Monitor(Manual)].

#### Note

- When the monitor is pulled out, the eye sensor of the camera will not detect your eye approaching even if [FINDER/MONITOR] is set to [Auto]. The image will continue to be displayed on the monitor.

---

### Related Topic

- [Custom Key\(Shoot.\)/Custom Key\(PB\)](#)

Digital Still Camera  
DSC-RX10M4

## Deactivate Monitor

---

When you press the key to which the [Deactivate Monitor] function has been assigned, the monitor turns black, and the screen display is locked to [No Disp. Info.].

- 1 MENU →  2 (Camera Settings2) → [Custom Key(Shoot.)] → set the [Deactivate Monitor] function to the desired key.
- 2 Press the key to which [Deactivate Monitor] is assigned.
  - To return to the display, press the key to which [Deactivate Monitor] is assigned again.

### Note

- Even if you perform [Deactivate Monitor], the backlight of monitor remains on. To turn off the backlight, switch the monitor mode to viewfinder mode using the [FINDER/MONITOR] function.

---

### Related Topic

- [Custom Key\(Shoot.\)/Custom Key\(PB\)](#)
- [Switching the screen display \(while shooting/during playback\)](#)
- [FINDER/MONITOR](#)

Digital Still Camera  
DSC-RX10M4

## Monitor Brightness

---

Adjust the brightness of the screen.

- 1 MENU →  (Setup) → [Monitor Brightness] → desired setting.

### Menu item details



#### Manual:

Adjusts the brightness within the range of -2 to +2.

#### Sunny Weather:

Sets the brightness appropriately for shooting outdoors.

#### Note

- The [Sunny Weather] setting is too bright for shooting indoors. Set [Monitor Brightness] to [Manual] for indoor shooting.
- The monitor brightness cannot be adjusted in the following situations. The maximum brightness will be [±0].
  - When [  File Format] is set to [XAVC S 4K].
  - When [  File Format] is set to [XAVC S HD] and [  Record Setting] is set to [120p]/[100p].
  - During High Frame Rate shooting
- The monitor brightness is locked at [-2] when shooting a movie using the Wi-Fi functions.

Digital Still Camera  
DSC-RX10M4

## Viewfinder Bright.

When using an electronic viewfinder, this product adjusts the brightness of the electronic viewfinder according to the surrounding environment.

1 MENU →  (Setup) → [Viewfinder Bright.] → desired setting.

### Menu item details



#### Auto:

Adjusts the brightness automatically.

#### Manual:

Selects the brightness of the electronic viewfinder within the range of -2 to +2.

#### Note

- The electronic viewfinder brightness cannot be adjusted in the following situations. The maximum brightness will be [±0].
  - When [  File Format] is set to [XAVC S 4K].
  - When [  File Format] is set to [XAVC S HD] and [  Record Setting] is set to [120p]/[100p].
  - During High Frame Rate shooting

Digital Still Camera  
DSC-RX10M4

## Finder Color Temp.

---

Adjusts the color temperature of the electronic viewfinder.

**1** MENU →  (Setup) → [Finder Color Temp.] → desired setting.

### Menu item details

#### **-2 to +2:**

When you select “-,” the viewfinder screen changes to a warmer color, and when you select “+,” it changes to a colder color.

Digital Still Camera  
DSC-RX10M4

## Display Quality

---

You can change the display quality.

**1** MENU →  (Setup) → [Display Quality] → desired setting.

### Menu item details

**High:**

Displays in high quality.

**Standard:**

Displays in standard quality.

**Note**

- When [High] is set, battery consumption will be higher than when [Standard] is set.

## Bright Monitoring

Allows you to adjust the composition when shooting in dark environments. By extending the exposure time, you can check the composition on the viewfinder/monitor even in dark locations such as under the night sky.

- 1 MENU →  2 (Camera Settings2) → [Custom Key(Shoot.)] → assign the [Bright Monitoring] function to the desired key.
- 2 Press the key to which you assigned the [Bright Monitoring] function, then shoot an image.
  - The brightness due to [Bright Monitoring] will continue after shooting.
  - To return the monitor brightness to normal, press the key to which you assigned the [Bright Monitoring] function once again.

### Note

- During [Bright Monitoring], [Live View Display] will automatically switch to [Setting Effect OFF], and setting values such as exposure compensation will not be reflected in the live view display. It is recommended that you use [Bright Monitoring] only in dark locations.
- [Bright Monitoring] will be automatically cancelled in the following situations.
  - When the camera is turned off.
  - When the shooting mode is changed from P/A/S/M to a mode that is not P/A/S/M.
  - When the focus mode is set to other than manual focus.
  - When [ MF Assist] is executed.
  - When [Focus Magnifier] is selected.
- During [Bright Monitoring], the shutter speed may be slower than normal while shooting in dark locations. Also, because the measured brightness range is expanded, the exposure may change.

### Related Topic

- [Live View Display](#)



Digital Still Camera  
DSC-RX10M4

## Format

---

When you use a memory card with this camera for the first time, we recommend that you format the card using the camera for stable performance of the memory card. Note that formatting permanently erases all data on the memory card, and is unrecoverable. Save valuable data on a computer, etc.

1 MENU →  (Setup) → [Format].

### Note

- Formatting permanently erases all data including protected images and registered settings (from M1 to M4).
- The access lamp lights up during formatting. Do not remove the memory card while the access lamp is lit up.
- Format the memory card on this camera. If you format the memory card on the computer, the memory card may not be usable depending on the format type.
- It may take a few minutes to complete formatting, depending on the memory card.
- You cannot format the memory card if the remaining battery charge is less than 1%.

Digital Still Camera  
DSC-RX10M4

## File Number

---

Selects how to assign file numbers to still images.

**1** MENU →  (Setup) → [File Number] → desired setting.

### Menu item details

**Series :**

The product will assign numbers to files sequentially up to "9999" without resetting.

**Reset :**

The product resets numbers when a file is recorded in a new folder and assigns numbers to files starting with "0001".

(When the recording folder contains a file, a number one higher than the largest number is assigned.)

Digital Still Camera  
DSC-RX10M4

## Set File Name

---

You can specify the first three characters of the file name for images you shoot.

- 1 MENU →  (Setup) → [Set File Name].
- 2 Select the entry field for the file name to display a keyboard on the screen, and then enter three characters of your choice.

### Note

- Only capital letters, numbers, and underscores can be entered. However, an underscore cannot be used as the first character.
- The three characters of the file name you specify using [Set File Name] will only be applied to images you shoot after changing the setting.

---

### Related Topic

- [How to use the keyboard](#)

Digital Still Camera  
DSC-RX10M4

## Display Media Info.

---

Displays the recordable time of movies for the inserted memory card. Also displays the number of recordable still images for the inserted memory card.

**1** MENU →  (Setup) → [Display Media Info.].

Digital Still Camera  
DSC-RX10M4

## Select REC Folder

---

If [Folder Name] is set to [Standard Form] and there are 2 folders or more, you can select the folder on the memory card to which images are to be recorded.

1 MENU →  (Setup) → [Select REC Folder] → desired folder.

### Note

- You cannot select the folder when [Folder Name] is set to [Date Form].

---

### Related Topic

- [Folder Name](#)

Digital Still Camera  
DSC-RX10M4

## New Folder

---

Creates a new folder on the memory card for recording still images. A new folder is created with a folder number one greater than the largest folder number currently used. Images are recorded in the newly created folder.

1 MENU →  (Setup) → [New Folder].

### Note

- When you insert a memory card that was used with other equipment into this product and shoot images, a new folder may be automatically created.
- Up to 4,000 images in total can be stored in one folder. When the folder capacity is exceeded, a new folder may be automatically created.

Digital Still Camera  
DSC-RX10M4

## Folder Name

---

Still images are recorded in a folder that is automatically created inside the DCIM folder on the memory card. You can change the way folder names are assigned.

1 MENU →  (Setup) → [Folder Name] → desired setting.

### Menu item details

#### Standard Form:

The folder name form is as follows: folder number + MSDCF.

Example: 100MSDCF

#### Date Form:

The folder name form is as follows: folder number + Y (the last digit)/MM/DD.

Example: 10070405 (Folder number: 100, date: 04/05/2017)

#### Note

- You cannot change the [Folder Name] settings for movies.

Digital Still Camera  
DSC-RX10M4

## Recover Image DB

---

If image files were processed on a computer, problems may occur in the image database file. In such cases, the images on the memory card will not be played back on this product. If these problems happen, repair the file using [Recover Image DB].

1 MENU →  (Setup) → [Recover Image DB] → [Enter].

### Note

- Use a sufficiently charged battery pack. Low battery power during repairing can cause damage to data.



Digital Still Camera  
DSC-RX10M4

## Audio signals

---

Selects whether the product produces a sound or not.

**1** MENU →  **2** (Camera Settings2) → [Audio signals] → desired setting.

### Menu item details

**On:**

Sounds are produced for example when the focus is achieved by pressing the shutter button halfway down.

**Shutter:**

Only the shutter sound is produced.

**Off:**

Sounds are not produced.

**Note**



- If [Focus Mode] is set to [Continuous AF], the camera will not beep when it focuses on a subject.

Digital Still Camera  
DSC-RX10M4

## Write Date (still image)

---

Sets whether to record a shooting date on the still image.

1 MENU →  2 (Camera Settings2) → [ Write Date] → desired setting.

### Menu item details

**On:**

Records a shooting date.

**Off:**

Does not record a shooting date.

**Note**

- If you shoot images with the date once, you cannot delete the date from the images later.
- The dates are doubly printed if you set the product to print dates when printing the images using PCs or printers.
- The recorded time of the image cannot be superimposed on the image.
- [ Write Date] is not available for RAW images.

Digital Still Camera  
DSC-RX10M4

## Tile Menu

---

Selects whether to always display the first screen of the menu when you press the MENU button.

**1** MENU →  (Setup) → [Tile Menu] → desired setting.

### Menu item details

**On:**

Always displays the first screen of the menu (Tile Menu).

**Off:**

Deactivates the Tile Menu display.

Digital Still Camera  
DSC-RX10M4

## Mode Dial Guide

---

You can display the description of a shooting mode when you turn the mode dial and change the settings available for that shooting mode.

**1** MENU →  (Setup) → [Mode Dial Guide] → desired setting.

### Menu item details

**On:**

Displays the Mode Dial Guide.

**Off:**

Does not display the Mode Dial Guide.

Digital Still Camera  
DSC-RX10M4

## Pwr Save Start Time

---

Sets time intervals to automatically switch to power save mode when you are not performing operations to prevent wearing down the battery pack. To return to shooting mode, perform an operation such as pressing the shutter button halfway down.

1 MENU →  (Setup) → [Pwr Save Start Time] → desired setting.

### Menu item details

30 Min/5 Min/2 Min/1 Min/10 Sec

#### Note

- Turn off the product when you do not use it for a long time.
- The power save function is not activated when power is being supplied via USB, when playing back slideshows, when recording movies, or when connected to a computer or TV.

Digital Still Camera  
DSC-RX10M4

## NTSC/PAL Selector

---

Plays back movies recorded with the product on a NTSC/PAL system TV.

**1** MENU →  (Setup) → [NTSC/PAL Selector] → [Enter]

### Note

- If you insert a memory card that has previously been formatted with a different video system, a message telling you that you must reformat the card will appear.  
If you want to record using another system, re-format the memory card or use another memory card.
- When you perform [NTSC/PAL Selector], and the setting is changed from the default one, a message "Running on NTSC." or "Running on PAL." will appear on the start-up screen.

Digital Still Camera  
DSC-RX10M4

## HDMI Settings: HDMI Resolution

When you connect the product to a High Definition (HD) TV with HDMI terminals using an HDMI cable (sold separately), you can select HDMI Resolution to output images to the TV.

**1** MENU →  (Setup) → [HDMI Settings] → [HDMI Resolution] → **desired setting.**

### Menu item details

**Auto:**

The product automatically recognizes an HD TV and sets the output resolution.

**2160p/1080p:**

Outputs signals in 2160p/1080p.

**1080p:**

Outputs signals in HD picture quality (1080p).

**1080i:**



Outputs signals in HD picture quality (1080i).

**Note**

- If the images are not displayed properly using the [Auto] setting, select either [1080i], [1080p] or [2160p/1080p], based on which TV is to be connected.

## HDMI Settings: 24p/60p Output (movie) (Only for 1080 60i compatible models)

You can set 1080/24p or 1080/60p as the HDMI output format when [  Record Setting ] is set to [24p 50M].

- 1 MENU →  (Setup) → [HDMI Settings] → [HDMI Resolution] → [1080p] or [2160p/1080p].
- 2 MENU →  (Setup) → [HDMI Settings] → [  24p/60p Output ] → desired setting.

### Menu item details

#### 60p:

Movies are output as 60p.

#### 24p:

Movies are output as 24p.

#### Note

- Steps 1 and 2 can be set in either order.
- When [  Record Setting ] is set to other than [24p 50M], this setting is canceled, and HDMI video is output according to the [HDMI Resolution] settings.

### Related Topic

- [Record Setting \(movie\)](#)



Digital Still Camera  
DSC-RX10M4

## HDMI Settings: HDMI Info. Display

Selects whether to display the shooting information when this product and the TV are connected using an HDMI cable (sold separately).

1 MENU →  (Setup) → [HDMI Settings] → [HDMI Info. Display] → desired setting.

### Menu item details

#### On:

Displays the shooting information on the TV.

The recorded image and the shooting information are displayed on the TV, while nothing is displayed on the camera's monitor.

#### Off:

Does not display the shooting information on the TV.

Only the recorded image is displayed on the TV, while the recorded image and the shooting information are displayed on the camera's monitor.

#### Note

- When this product is connected to a 4K-compatible TV, [Off] is selected automatically.
- If you set [ File Format] to [XAVC S 4K] and shoot movies while the camera is connected to an HDMI device, images will not be displayed on the monitor.

## HDMI Settings: TC Output (movie)

---

Sets whether or not to layer the TC (time code) information on the output signal via the HDMI terminal when outputting the signal to other professional-use devices.

This function layers the time code information on the HDMI output signal. The product sends the time code information as digital data, not as an image displayed on the screen. The connected device can then refer to the digital data to recognize the time data.

**1** MENU →  (Setup) → [HDMI Settings] → [ TC Output] → **desired setting.**

### Menu item details



**On:**

Time code is output to other devices.

**Off:**

Time code is not output to other devices.

**Note**

- When [ TC Output] is set to [On], the image may not be output properly to the TV or recording device. In such cases, set [ TC Output] to [Off].

Digital Still Camera  
DSC-RX10M4

## HDMI Settings: REC Control (movie)

If you connect the camera to an external recorder/player, you can remotely command the recorder/player to start/stop recording using the camera.

1 MENU →  (Setup) → [HDMI Settings] → [ REC Control] → desired setting.

### Menu item details

On:







 STBY The camera can send a recording command to an external recorder/player.

 REC The camera is sending a recording command to an external recorder/player.

Off:

The camera is not able to send a command to an external recorder/player to start/stop recording.

#### Note

- Available for external recorders/players compatible with [ REC Control].
- When you use the [ REC Control] function, set the shooting mode to  (Movie).
- When [ TC Output] is set to [Off], you cannot use the [ REC Control] function.
- Even when  REC is displayed, the external recorder/player may not work properly depending on the settings or status of the recorder/player. Check if the external recorder/player works properly before use.

Digital Still Camera  
DSC-RX10M4

## HDMI Settings: CTRL FOR HDMI

When connecting this product to a “BRAVIA” Sync-compatible TV using an HDMI cable (sold separately), you can operate this product by aiming the TV remote control at the TV.

1 MENU →  (Setup) → [HDMI Settings] → [CTRL FOR HDMI] → desired setting.

2 Connect this product to a “BRAVIA” Sync-compatible TV.

The input of the TV is switched automatically and images on this product are displayed on the TV screen.

3 Press the SYNC MENU button of the TV’s remote control.

4 Operate this product using the TV’s remote control.

### Menu item details

#### On:

You can operate this product with a TV’s remote control.

#### Off:

You cannot operate this product with a TV’s remote control.

#### Note

- If you connect this product to a TV using an HDMI cable, available menu items are limited.
- [CTRL FOR HDMI] is available only with a “BRAVIA” Sync-compatible TV. Also, the SYNC MENU operation differs depending on the TV you are using. For details, refer to the operating instructions supplied with the TV.
- If the product performs unwanted operations in response to the TV remote control when the product is connected to another manufacturer’s TV using an HDMI connection, select MENU →  (Setup) → [HDMI Settings] → [CTRL FOR HDMI] → [Off].

Digital Still Camera  
DSC-RX10M4

## USB Connection

---

Selects the USB connection method when this product is connected to a computer, etc.

1 MENU →  (Setup) → [USB Connection] → desired setting.

### Menu item details

#### Auto:

Establishes a Mass Storage or MTP connection automatically, depending on the computer or other USB devices to be connected. Windows 7, Windows 8.1, or Windows 10 computers are connected in MTP, and their unique functions are enabled for use.

#### Mass Storage:

Establishes a Mass Storage connection between this product, a computer, and other USB devices.

#### MTP:

Establishes an MTP connection between this product, a computer, and other USB devices. Windows 7, Windows 8.1, or Windows 10 computers are connected in MTP, and their unique functions are enabled for use.

#### PC Remote:

Uses “Remote Camera Control” to control this product from the computer, including such functions as shooting and storing images on the computer.

#### Note

- It may take some time to make the connection between this product and a computer when [USB Connection] is set to [Auto].

---

### Related Topic

- [PC Remote Settings: Still Img. Save Dest.](#)
- [PC Remote Settings: RAW+J PC Save Img](#)

Digital Still Camera  
DSC-RX10M4

## USB LUN Setting

---

Enhances compatibility by limiting of USB connection functions.

**1** MENU →  (Setup) → [USB LUN Setting] → desired setting.

### Menu item details

**Multi:**

Normally, use [Multi].

**Single:**

Set [USB LUN Setting] to [Single] only if you cannot make a connection.

Digital Still Camera  
DSC-RX10M4

## USB Power Supply

---

Sets whether to supply power via the micro USB cable when the product is connected to a computer or an USB device.

**1** MENU →  (Setup) → [USB Power Supply] → desired setting.

### Menu item details

**On:**

Power is supplied to the product via a micro USB cable when the product is connected to a computer, etc.

**Off:**

Power is not supplied to the product via a micro USB cable when the product is connected to a computer, etc. If you use the supplied AC Adaptor, power will be supplied even when [Off] is selected.

**Note**

- Insert the battery pack into the product to supply power via USB cable.

Digital Still Camera  
DSC-RX10M4

## PC Remote Settings: Still Img. Save Dest.

Sets whether to save still images stored in both the camera and the computer during PC Remote shooting. This setting is useful when you want to check recorded images on the camera without leaving the camera.

\* PC Remote: Uses "Remote Camera Control" to control this product from the computer, including such functions as shooting and storing images on the computer.

**1** MENU →  (Setup) → [PC Remote Settings] → [Still Img. Save Dest.] → desired setting.

### Menu item details

#### PC Only:

Saves still images only on the computer.

#### PC+Camera:

Saves still images on the computer and the camera.

#### Note

- During PC Remote shooting, you cannot change settings for [Still Img. Save Dest.]. Adjust the settings before you start shooting.
- If you insert a memory card that is not recordable, you cannot shoot still images even if you select [PC+Camera].
- If you select [PC+Camera] and you have not inserted a memory card into the camera, you cannot release the shutter even if [Release w/o Card] is set to [Enable].
- While you are playing back still images on the camera, you cannot shoot using PC Remote.

### Related Topic

- [USB Connection](#)
- [Release w/o Card](#)
- [PC Remote Settings: RAW+J PC Save Img](#)



Digital Still Camera  
DSC-RX10M4

## PC Remote Settings: RAW+J PC Save Img

---

Selects the file type for images to be transferred to the computer in PC Remote shooting.

When shooting still images using PC Remote, the application on the computer does not display the image until the image has been completely transferred. When performing RAW+JPEG shooting, you can accelerate the display processing speed by transferring only JPEG images instead of transferring both RAW and JPEG images.

\* PC Remote: Uses "Remote Camera Control" to control this product from the computer, including such functions as shooting and storing images on the computer.

1 MENU →  (Setup) → [PC Remote Settings] → [RAW+J PC Save Img] → desired setting.

### Menu item details

#### RAW & JPEG:

Transfers both RAW and JPEG files to the computer.

#### JPEG Only:

Transfers only JPEG files to the computer.

#### RAW Only:

Transfers only RAW files to the computer.

#### Note

- [RAW+J PC Save Img] can be set only when [ Quality] is set to [RAW & JPEG].

---

### Related Topic

- [USB Connection](#)
- [Quality \(still image\)](#)
- [PC Remote Settings: Still Img. Save Dest.](#)

Digital Still Camera  
DSC-RX10M4

## Language

---

Selects the language to be used in the menu items, warnings and messages.

**1** MENU →  (Setup) → [ Language] → **desired language.**

Digital Still Camera  
DSC-RX10M4

## Date/Time Setup

---

The Clock Set screen is displayed automatically when you turn on this product for the first time or when the internal rechargeable backup battery has fully discharged. Select this menu when setting the date and time after the first time.

1 MENU →  (Setup) → [Date/Time Setup] → desired setting.

### Menu item details

**Daylight Savings:**

Selects Daylight Savings [On]/[Off].

**Date/Time:**

Sets the date and time.

**Date Format:**

Selects the date and time display format.

#### Hint

- To charge the internal rechargeable backup battery, insert a charged battery pack, and leave the product for 24 hours or more with the power off.
- If the clock resets every time the battery is charged, the internal rechargeable backup battery may be worn out. Consult your service facility.

Digital Still Camera  
DSC-RX10M4

## Area Setting

---

Sets the area where you are using the product.

**1** MENU →  (Setup) → [Area Setting] → desired area.

Digital Still Camera  
DSC-RX10M4

## Copyright Info

---

Writes copyright information onto the still images.

- 1 **MENU** →  (Setup) → **[Copyright Info]** → **desired setting.**
- 2 **When you select [Set Photographer] or [Set Copyright], a keyboard appears on the screen. Enter your desired name.**

### Menu item details

#### Write Copyright Info:

Sets whether to write copyright information. ([On]/[Off])

- If you select [On], an  icon will appear on the shooting screen.

#### Set Photographer:

Sets the photographer name.

#### Set Copyright:

Sets the copyright holder name.

#### Disp. Copyright Info:

Displays the current copyright information.

#### Note

- You can only enter alphanumeric characters and symbols for [Set Photographer] and [Set Copyright]. You can enter up to 46 letters.
- A  icon appears during the playback of images with copyright information.
- In order to prevent unauthorized use of [Copyright Info], be sure to clear the [Set Photographer] and [Set Copyright] columns before lending out or handing over your camera.
- Sony is not liable for problems or damages resulting from use of [Copyright Info].

---

### Related Topic

- [How to use the keyboard](#)

Digital Still Camera  
DSC-RX10M4

## Version

---

Displays the version of this product's software. Check the version when updates for this product's software are released, etc.

1 MENU →  (Setup) → [Version].

### Note

- Updating can be performed only when the battery level is  (3 remaining battery bars) or more. The use of a sufficiently charged battery or the AC Adaptor (sold separately) is recommended.

Digital Still Camera  
DSC-RX10M4

## Demo Mode

---

The [Demo Mode] function displays the movies recorded on the memory card automatically (demonstration), when the camera has not been operated for a certain time. Normally select [Off].

**1** MENU →  (Setup) → [Demo Mode] → desired setting.

### Menu item details

#### On:

The movie playback demonstration starts automatically if the product is not operated for about one minute. Only protected AVCHD movies can be played back.

Set the view mode to [AVCHD View], and protect the movie file with the oldest recorded date and time.

#### Off:

Does not show the demonstration.

#### Note

- You can set this item only when the product is powered by the AC Adaptor (supplied).
- When there is no protected AVCHD movies on the memory card, you cannot select [On].

Digital Still Camera  
DSC-RX10M4

## Setting Reset

---

Resets the product to the default settings. Even if you perform [Setting Reset], the recorded images are retained.

**1** MENU →  (Setup) → [Setting Reset] → desired setting.

### Menu item details

#### Camera Settings Reset:

Initializes the main shooting settings to the default settings.

#### Initialize:

Initializes all the settings to the default settings.

#### Note

- Be sure not to eject the battery pack while resetting.
- Settings of [Picture Profile] will not be reset even when [Camera Settings Reset] or [Initialize] is performed.



Digital Still Camera  
DSC-RX10M4

## PlayMemories Mobile

---

Using the smartphone application PlayMemories Mobile, you can shoot an image while controlling the camera using a smartphone or transfer the images recorded on the camera to the smartphone. Download and install the application PlayMemories Mobile from your smartphone's application store. If PlayMemories Mobile is already installed on your smartphone, be sure to update it to the latest version.

For details on PlayMemories Mobile, refer to the support page (<http://www.sony.net/pmm/>).

### Note

- Depending on future version upgrades, the operational procedures or screen displays are subject to change without notice.

## Controlling the camera using an Android smartphone (NFC One-touch remote)

You can connect this product to an NFC-enabled Android smartphone by touching them together and then operate the product using the smartphone.

Make sure that [Ctrl w/ Smartphone] is set to [On] by selecting MENU →  (Network) → [Ctrl w/ Smartphone].

- 1 **Activate the NFC function of the smartphone.**
- 2 **Switch this product to shooting mode.**
  - The NFC function is available only when the  (N mark) is displayed on the screen.
- 3 **Touch the smartphone to the product.**

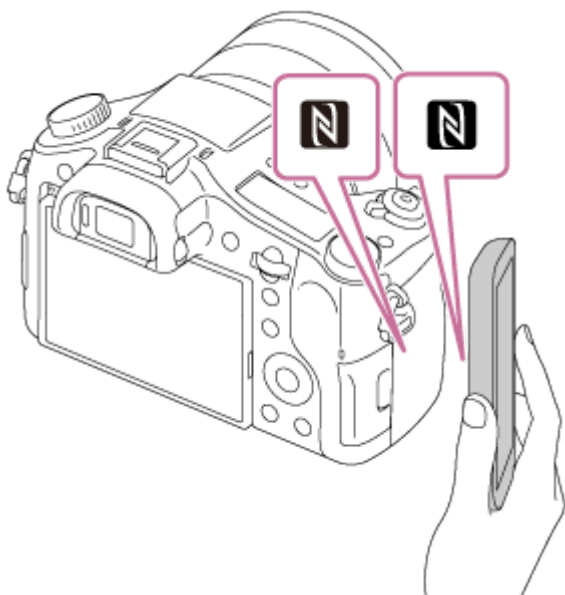

The smartphone and the product are connected, and PlayMemories Mobile launches.

- You can shoot an image by remote control while checking the composition of the image on the smartphone screen.
- Touch the smartphone to the product for 1-2 seconds until PlayMemories Mobile launches.

### About “NFC”

NFC is a technology that enables short-range wireless communication between various devices, such as mobile phones or IC tags, etc. NFC makes data communication simpler with just a touch on the designated touch-point.

- NFC (Near Field Communication) is an international standard of short-range wireless communication technology.

### Note

- If you cannot make a connection, do as the following:
  - Launch PlayMemories Mobile on your smartphone, and then move the smartphone slowly toward the  (N mark) of this product.
  - If the smartphone is in a case, remove it.
  - If the product is in a case, remove it.

- Check whether the NFC function is activated on your smartphone.
- Radio wave interference may occur as Bluetooth communications and Wi-Fi communications use the same frequency band. If your Wi-Fi connection is unstable, it may be improved by turning off the Bluetooth function of the smartphone. If you do this, the location information link function is not available.
- When you record movies using a smartphone as a remote controller, the monitor of the product becomes darker.
- When [Airplane Mode] is set to [On], you cannot connect this product and the smartphone. Set [Airplane Mode] to [Off].
- If this product and the smartphone are connected when the product is in playback mode, the displayed image is sent to the smartphone.

---

---

### Related Topic

- [PlayMemories Mobile](#)
- [Airplane Mode](#)

## Controlling the camera using an Android smartphone (QR code)

You can control this product using your smartphone by connecting your smartphone to the camera using the QR code. Make sure that [Ctrl w/ Smartphone] is set to [On] by selecting MENU →  (Network) → [Ctrl w/ Smartphone].

- 1 MENU →  (Network) → [Ctrl w/ Smartphone] → [ Connection].

QR code (A) and the SSID (B) are displayed on the monitor of this product.

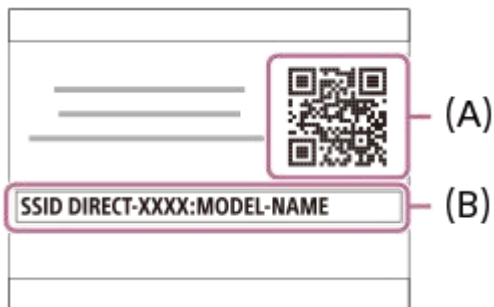

- 2 Launch PlayMemories Mobile on your smartphone and select [Scan QR Code of the Camera].

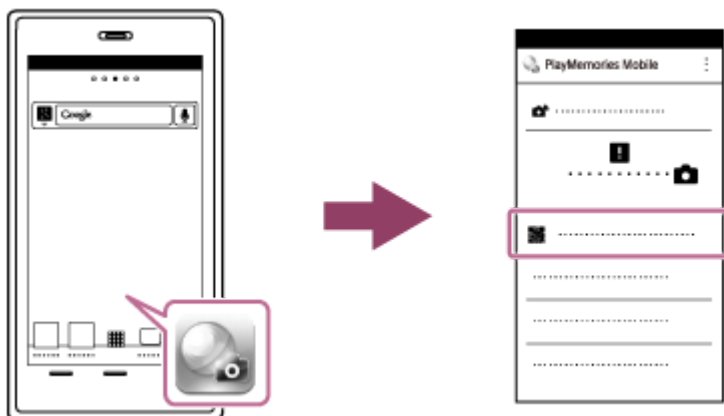

- 3 Select [OK] on the smartphone screen.

- When a message is displayed, select [OK] again.



- 4 Read the QR code displayed on the monitor of this product with the smartphone.

Once the QR code has been read, a message [Connect with the camera?] will be displayed on the smartphone screen.

**5 Select [OK] on the smartphone screen.**

The smartphone is connected to the product.

- You can now shoot images remotely while checking the composition on the smartphone screen.

**Hint**

- Once the QR code has been read, this product's SSID (DIRECT-xxxx) and password are registered to the smartphone. This enables you to easily connect the smartphone to the product via Wi-Fi at a later date by selecting the SSID. (Set [Ctrl w/ Smartphone] to [On] in advance.)

**Note**

- Radio wave interference may occur as Bluetooth communications and Wi-Fi communications use the same frequency band. If your Wi-Fi connection is unstable, it may be improved by turning off the Bluetooth function of the smartphone. If you do this, the location information link function is not available.
- When you record movies using a smartphone as a remote controller, the monitor of the product becomes darker.
- If you cannot connect your smartphone to this product using the [One-touch(NFC)] function or QR code, use the SSID and password.

---

**Related Topic**

- [PlayMemories Mobile](#)
- [Controlling the camera using an Android smartphone \(SSID\)](#)

Digital Still Camera  
DSC-RX10M4

## Controlling the camera using an Android smartphone (SSID)

You can control this product using your smartphone by connecting your smartphone to the camera using the SSID and password.

Make sure that [Ctrl w/ Smartphone] is set to [On] by selecting MENU →  (Network) → [Ctrl w/ Smartphone].

- 1 MENU →  (Network) → [Ctrl w/ Smartphone] → [ Connection].

QR code is displayed on the monitor of this product.

- 2 Press the  (Delete) button of this product.

This product's SSID and password are displayed on the monitor of this product.



- 3 Launch PlayMemories Mobile on your smartphone.

- 4 Select the model name of this product (DIRECT-xxxx: xxxx).



- 5 Input the password that is displayed on this product.



The smartphone is connected to the product.

- You can now shoot images remotely while checking the composition on the smartphone screen.

### Note

- Radio wave interference may occur as Bluetooth communications and Wi-Fi communications use the same frequency band. If your Wi-Fi connection is unstable, it may be improved by turning off the Bluetooth function of the smartphone. If you do this, the location information link function is not available.
- When you record movies using a smartphone as a remote controller, the monitor of the product becomes darker.

---

### Related Topic

- [PlayMemories Mobile](#)

## Controlling the camera using an iPhone or iPad (QR code)

You can connect an iPhone or iPad to the camera using the QR code and operate the camera using the iPhone or iPad. Make sure that [Ctrl w/ Smartphone] is set to [On] by selecting MENU →  (Network) → [Ctrl w/ Smartphone].

- 1 MENU →  (Network) → [Ctrl w/ Smartphone] → [ Connection].

QR code (A) and the SSID (B) are displayed on the monitor of this product.

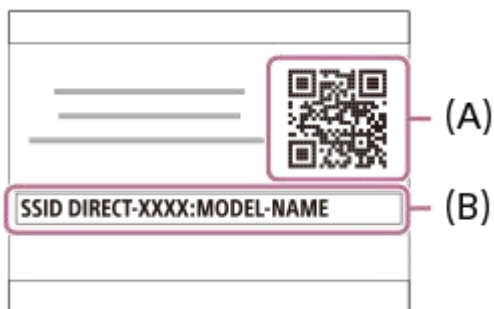

- 2 Launch PlayMemories Mobile on your iPhone or iPad and select [Scan QR Code of the Camera].

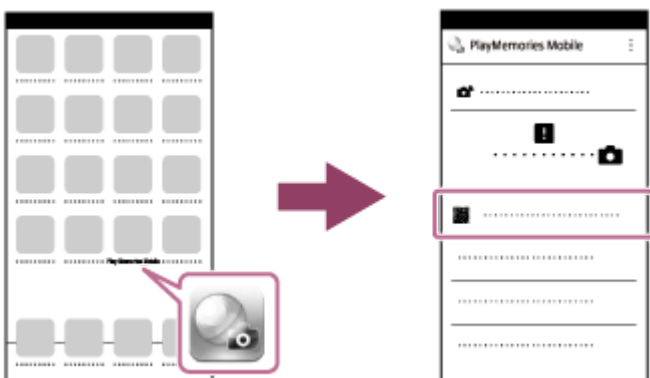

- 3 Select [OK] on the iPhone or iPad screen.

- When a message is displayed, select [OK] again.



- 4 Read the QR code displayed on the monitor of this product with the iPhone or iPad.



**5 Install the profile (setting information) by following the instructions shown on the iPhone or iPad screen and select [OK].**

The profile will be installed to the iPhone or iPad.

- If you have activated the passcode lock function for your iPhone or iPad, you will need to enter the passcode. Enter the passcode that you set for your iPhone or iPad.



**6 Select [Settings] on the "Home" screen → [Wi-Fi] → the SSID for this product on the iPhone or iPad.**

The iPhone or iPad will connect to the product.



**7 Return to the "Home" screen of the iPhone or iPad and launch PlayMemories Mobile.**

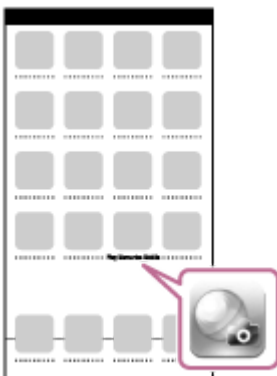

- You can now shoot images remotely while checking the composition on the screen of your iPhone or iPad.

**Hint**

- Once the QR code has been read, this product's SSID (DIRECT-xxxx) and password are registered to the iPhone or iPad. This enables you to easily connect the iPhone or iPad to the product via Wi-Fi at a later date by selecting the SSID. (Set [Ctrl w/ Smartphone] to [On] in advance.)

## Note

- Radio wave interference may occur as Bluetooth communications and Wi-Fi communications use the same frequency band. If your Wi-Fi connection is unstable, it may be improved by turning off the Bluetooth function of the smartphone. If you do this, the location information link function is not available.
- When you record movies using a smartphone as a remote controller, the monitor of the product becomes darker.
- If you cannot connect your iPhone or iPad to this product using the QR code, use the SSID and password.

---

## Related Topic

- [PlayMemories Mobile](#)
- [Controlling the camera using an iPhone or iPad \(SSID\)](#)

4-725-901-11(2) Copyright 2017 Sony Corporation

Digital Still Camera  
DSC-RX10M4

## Controlling the camera using an iPhone or iPad (SSID)

You can control the camera using an iPhone or iPad by connecting the iPhone or iPad to the camera using the SSID and password.

Make sure that [Ctrl w/ Smartphone] is set to [On] by selecting MENU →  (Network) → [Ctrl w/ Smartphone].

- 1 MENU →  (Network) → [Ctrl w/ Smartphone] → [ Connection].**

QR code is displayed on the monitor of this product.

- 2 Press the  (Delete) button of this product.**

This product's SSID and password are displayed on the monitor of this product.



- 3 Select the model name of this product (DIRECT-xxxx: xxxx) on the Wi-Fi setting screen of your iPhone or iPad.**



- 4 Input the password that is displayed on this product.**



The iPhone or iPad is connected to the product.

**5** Confirm that your iPhone or iPad was connected to the “SSID” shown on this product.



**6** Return to the "Home" screen of the iPhone or iPad and launch PlayMemories Mobile.



- You can now shoot images remotely while checking the composition on the screen of your iPhone or iPad.

**Note**

- Radio wave interference may occur as Bluetooth communications and Wi-Fi communications use the same frequency band. If your Wi-Fi connection is unstable, it may be improved by turning off the Bluetooth function of the smartphone. If you do this, the location information link function is not available.
- When you record movies using a smartphone as a remote controller, the monitor of the product becomes darker.

**Related Topic**

- [PlayMemories Mobile](#)

Digital Still Camera  
DSC-RX10M4

## Snd to Smrtphn Func: Send to Smartphone

You can transfer still images, XAVC S movies, or high-frame-rate movies to a smartphone and view them. The application PlayMemories Mobile must be installed on your smartphone.

**1 MENU →  (Network) → [Snd to Smrtphn Func] → [Send to Smartphone] → desired setting.**

- If you press the  (Send to Smartphone) button in playback mode, the setting screen for [Send to Smartphone] will appear.

**2 If the product is ready for the transfer, the information screen appears on the product. Connect the smartphone and the product using that information.**

- The setting method for connecting the smartphone and the product varies depending on the smartphone.



### Menu item details

#### Select on This Device:

Selects an image on the product to be transferred to the smartphone.

(1) Select from among [This Image], [All with this date] or [Multiple Images].

- The options displayed may differ depending on the View Mode selected on the camera.

(2) If you select [Multiple Images], select the desired images using the center of the control wheel, then press MENU → [Enter].

#### Select on Smartphone:

Displays all images recorded on the product's memory card on the smartphone.

#### Note

- You can only transfer images that are saved on the camera's memory card.
- You can select an image size to be sent to the smartphone from [Original], [2M] or [VGA]. To change the image size, refer to the following steps.
  - For Android smartphone  
Start PlayMemories Mobile, and change the image size by [Settings] → [Copy Image Size].
  - For iPhone/iPad  
Select PlayMemories Mobile in the setting menu, and change the image size by [Copy Image Size].
- RAW images are converted to JPEG format when they are sent.
- You cannot send AVCHD format movies.
- You cannot transfer XAVC S 4K movies or the original data of XAVC S HD movies recorded in [120p]/[100p] to a smartphone. You can only transfer proxy movies.

- Depending on the smartphone, the transferred movie may not be played back correctly. For example, the movie may not play smoothly, or there may be no sound.
- Depending on the format of the still image, movie, or high-frame-rate movie, it may not be possible to play it back on a smartphone.
- This product shares the connection information for [Send to Smartphone] with a device that has permission to connect. If you want to change the device that is permitted to connect to the product, reset the connection information by following these steps. MENU →  (Network) → [Wi-Fi Settings] → [SSID/PW Reset]. After resetting the connection information, you must register the smartphone again.
- When [Airplane Mode] is set to [On], you cannot connect this product and the smartphone. Set [Airplane Mode] to [Off].
- While you transfer many images or long movies, we recommend that you supply power to the camera from a wall outlet (wall socket) using the AC Adaptor (supplied).

---

## Related Topic

- [PlayMemories Mobile](#)
- [Controlling the camera using an Android smartphone \(QR code\)](#)
- [Controlling the camera using an Android smartphone \(SSID\)](#)
- [Controlling the camera using an iPhone or iPad \(QR code\)](#)
- [Controlling the camera using an iPhone or iPad \(SSID\)](#)
- [Sending images to an Android smartphone \(NFC One-touch Sharing\)](#)
- [Send to Smartphone Func: Sending Target \(proxy movies\)](#)
- [Airplane Mode](#)

Digital Still Camera  
DSC-RX10M4

## Snd to Smrtphn Func: Sending Target (proxy movies)

---

When transferring XAVC S video to a smartphone with [Send to Smartphone], you can set whether to transfer the low-bit-rate proxy movie or the high-bit-rate original movie.

1 MENU →  (Network) → [Snd to Smrtphn Func] → [ Sending Target] → desired setting.

### Menu item details

#### Proxy Only:

Transfers only proxy movies.

#### Original Only:

Transfers only original movies.

#### Proxy & Original:

Transfers both proxy and original movies.

#### Note

- You cannot transfer XAVC S 4K movies or the original data of XAVC S HD movies recorded in [120p]/[100p] to a smartphone. You can only transfer proxy movies.
- While you transfer many images or long movies, we recommend that you supply power to the camera from a wall outlet (wall socket) using the AC Adaptor (supplied).

---

### Related Topic

- [Snd to Smrtphn Func: Send to Smartphone](#)
- [Proxy Recording](#)

## Sending images to an Android smartphone (NFC One-touch Sharing)

With just one touch, you can connect this product and an NFC-enabled Android smartphone, and send an image displayed on the product screen directly to the smartphone. You can transfer still images, XAVC S movies, and high-frame-rate movies.

- 1 **Activate the NFC function of the smartphone.**
- 2 **Display a single image on the product.**
- 3 **Touch the smartphone to the product.**

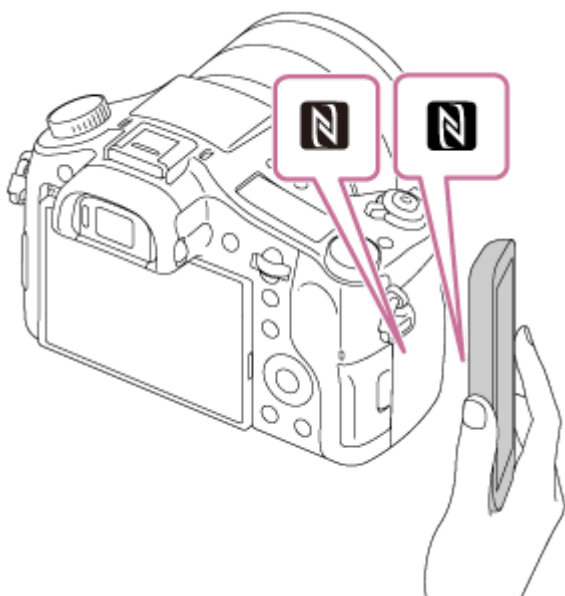

The product and the smartphone are connected, and PlayMemories Mobile automatically launches on the smartphone, and then the displayed image is sent to the smartphone.

- Before you touch the smartphone, cancel the sleep and lock-screen functions of the smartphone.
- The NFC function is available only when the **N** (N mark) is displayed on the product.
- Touch the smartphone to the product for 1-2 seconds until PlayMemories Mobile launches.
- To transfer two or more images, select MENU →  (Network) → [Snd to Smrtphn Func] → [Send to Smartphone] to select images. After the connection enabled screen appears, use NFC to connect the product and the smartphone.

### About “NFC”

NFC is a technology that enables short-range wireless communication between various devices, such as mobile phones or IC tags, etc. NFC makes data communication simpler with just a touch on the designated touch-point.

- NFC (Near Field Communication) is an international standard of short-range wireless communication technology.

#### Note

- You can select an image size to be sent to the smartphone from [Original], [2M] or [VGA]. To change the image size, refer to the following steps.



- Start PlayMemories Mobile, and change the image size by [Settings] → [Copy Image Size].
- RAW images are converted to JPEG format when they are sent.
- You cannot send AVCHD format movies.
- You cannot transfer XAVC S 4K movies or the original data of XAVC S HD movies recorded in [120p]/[100p] to a smartphone. You can only transfer proxy movies.
- Depending on the smartphone, the transferred movie may not be played back correctly. For example, the movie may not play smoothly, or there may be no sound.
- If the Image Index is displayed on the product, you cannot transfer images using the NFC function.
- If you cannot make a connection, do as the following:
  - Launch PlayMemories Mobile on your smartphone, and then move the smartphone slowly toward the  (N mark) of this product.
  - If the smartphone is in a case, remove it.
  - If the product is in a case, remove it.
  - Check whether the NFC function is activated on your smartphone.
- When [Airplane Mode] is set to [On], you cannot connect the product and the smartphone. Set [Airplane Mode] to [Off].

---

### Related Topic

- [PlayMemories Mobile](#)
- [Snd to Smrtphn Func: Send to Smartphone](#)
- [Snd to Smrtphn Func: Sending Target \(proxy movies\)](#)
- [Airplane Mode](#)

Digital Still Camera  
DSC-RX10M4

## Send to Computer

---

You can transfer images stored in the product to a computer connected to a wireless access point or wireless broadband router and easily make backup copies using this operation. Before starting this operation, install PlayMemories Home on your computer and register the access point on the product.

**1 Start your computer.**

**2 MENU** →  **(Network)** → **[Send to Computer]**.

### Note

- Depending on the application settings of your computer, the product will turn off after saving the images to your computer.
- You can transfer images from the product to only one computer at a time.
- If you want to transfer images to another computer, connect the product and the computer via a USB connection and follow the instructions in PlayMemories Home.
- Proxy movies cannot be transferred.

---

### Related Topic

- [Installing PlayMemories Home](#)
- [Wi-Fi Settings: WPS Push](#)
- [Wi-Fi Settings: Access Point Set.](#)

Digital Still Camera  
DSC-RX10M4

## View on TV

You can view images on a network-enabled TV by transferring them from the product without connecting the product and TV with a cable. For some TVs, you may need to perform operations on the TV. For details, refer to the operating instructions supplied with the TV.

1 MENU →  (Network) → [View on TV] → **desired device to be connected.**

2 When you want to play back images using slideshow, press the center of the control wheel.

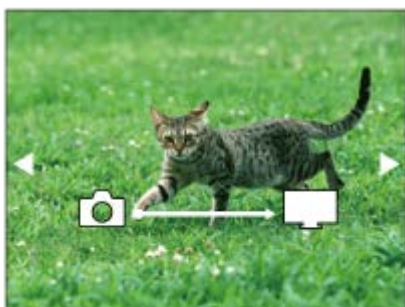

- To display the next/previous image manually, press the right/left sides of the control wheel.
- To change the device to be connected, press the down side of the control wheel, then select [Device list].

## Slideshow settings

You can change the slideshow settings by pressing the down side of the control wheel.

### Playback Selection:

Selects the group of images to be shown.

### Folder View(Still):

Selects from [All] and [All in Folder].

### Date View:

Selects from [All] and [All in Date Rng.].

### Interval:

Selects from [Short] and [Long].

### Effects\*:

Selects from [On] and [Off].

### Playback Image Size:

Selects from [HD] and [4K].

\* The settings are effective only for BRAVIA TV which is compatible with the functions.

### Note

- You can use this function on a TV that supports DLNA renderer.
- You can view images on a Wi-Fi Direct-enabled TV or network-enabled TV (including wired network-enabled TVs).
- If you connect TV and this product and do not use Wi-Fi Direct, you need to register your access point first.
- Displaying the images on the TV may take time.
- Movies cannot be shown on a TV via Wi-Fi. Use an HDMI cable (sold separately).

**Related Topic**

- [Wi-Fi Settings: WPS Push](#)
- [Wi-Fi Settings: Access Point Set.](#)

4-725-901-11(2) Copyright 2017 Sony Corporation

Digital Still Camera  
DSC-RX10M4

## Loc. Info. Link Set.

You can use the application PlayMemories Mobile to obtain location information from a smartphone that is connected with your camera using Bluetooth communication. You can record the obtained location information when shooting images.

### Preparation in advance









To use the location information linking function of the camera, the application PlayMemories Mobile is required. If "Location Information Linkage" is not displayed on the top page of PlayMemories Mobile, you need to perform the following steps beforehand.



1. Install PlayMemories Mobile on your smartphone.
  - You can install PlayMemories Mobile from the application store of your smartphone. If you have already installed the application, update it to the latest version.
2. Transfer a pre-recorded image to your smartphone using the [Send to Smartphone] function of the camera.
  - After you transfer an image recorded using the camera to your smartphone, "Location Information Linkage" will appear on the top page of the application.

### Operating procedure

: Operations performed on the smartphone

: Operations performed on the camera

1. : Confirm that the Bluetooth function of your smartphone is activated.
  - Do not perform the Bluetooth pairing operation on the smartphone setting screen. In steps 2 to 7, the pairing operation is performed using the camera and the application PlayMemories Mobile.
  - If you accidentally perform the pairing operation on the smartphone setting screen in step 1, cancel the pairing and then perform the pairing operation by following Steps 2 through 7 using the camera and the application PlayMemories Mobile.
2. : On the camera, select MENU →  (Network) → [Bluetooth Settings] → [Bluetooth Function] → [On].
3. : On the camera, select MENU →  (Network) → [Bluetooth Settings] → [Pairing].
4. : Launch PlayMemories Mobile on your smartphone and tap "Location Information Linkage."
  - If "Location Information Linkage" is not displayed, follow the steps in "Preparation in advance" above.
5. : Activate [Location Information Linkage] on the [Location Information Linkage] setting screen of PlayMemories Mobile.
6. : Follow the instructions on the [Location Information Linkage] setting screen of PlayMemories Mobile, and then select your camera from the list.
7. : Select [OK] when a message is displayed on the monitor of the camera.
  - Pairing of the camera and PlayMemories Mobile is complete.

8.  : On the camera, select MENU →  (Network) → [ Loc. Info. Link Set.] → [Location Info. Link] → [On].

-  (obtaining location information icon) will be displayed on the monitor of the camera. Location information obtained by your smartphone using GPS, etc., will be recorded when shooting images.

## Menu item details

### Location Info. Link:

Sets whether to obtain the location information by linking with a smartphone.

### Auto Time Correct.:

Sets whether to automatically correct the date setting of the camera using information from a linked smartphone.

### Auto Area Adjust.:

Sets whether to automatically correct the area setting of the camera using information from a linked smartphone.

## Icons displayed when obtaining the location information

 (Obtaining location information): The camera is obtaining the location information.

 (Location information cannot be obtained): The camera cannot obtain the location information.

 (Bluetooth connection available): Bluetooth connection with the smartphone is established.

 (Bluetooth connection unavailable): Bluetooth connection with the smartphone is not established.

### Hint

- Location information can be linked when PlayMemories Mobile is running on your smartphone even if the smartphone monitor is off. However, if the camera has been turned off for a while, location information may not be linked immediately when you turn the camera back on. In this case, location information will be linked immediately if you open the PlayMemories Mobile screen on the smartphone.
- When PlayMemories Mobile is not operating, such as when the smartphone is restarted, launch PlayMemories Mobile to resume location information linking.
- In the application PlayMemories Home, you can view images on a map by importing images with location information to your computer. For details, refer to Help for PlayMemories Home.
- If the location information linking function does not work properly, see the following notes and perform pairing again.
  - Confirm that the Bluetooth function of your smartphone is activated.
  - Confirm that the camera is not connected with other devices using the Bluetooth function.
  - Confirm that [Airplane Mode] for the camera is set to [Off].
  - Delete the pairing information for the camera registered in PlayMemories Mobile.
  - Execute [Reset Network Set.] of the camera.
- For more detailed video instructions, refer to the following support page.  
<http://www.sony.net/pmm/btg/>

### Note

- When you initialize the camera, the pairing information is also deleted. To perform pairing again, delete the pairing information for the camera registered in PlayMemories Mobile before trying again.
- The location information will not be recorded when it cannot be obtained, such as when the Bluetooth connection is disconnected.
- The camera can be paired with up to 15 Bluetooth devices, but can link the location information with that of only one smartphone. If you want to link the location information with that of another smartphone, turn off the [Location Information Linkage] function of the smartphone that is already linked.
- If the Bluetooth connection is unstable, remove any obstacles, such as people or metal objects from between the camera and the paired smartphone.
- When pairing the camera and your smartphone, be sure to use the [Location Information Linkage] menu on PlayMemories Mobile.

## Supported smartphones

- Android smartphones: Android 5.0 or later and compatible with Bluetooth 4.0 or later\*

- [iPhone/iPad: iPhone 4S or later/iPad 3rd generation or later](#)

\* As of September 2017. For the latest information, refer to the support site.

\* For the Bluetooth version, refer to the website for your smartphone.

---

---

## Related Topic

- [PlayMemories Home](#)
- [PlayMemories Mobile](#)
- [Snd to Smrtphn Func: Send to Smartphone](#)
- [Bluetooth Settings](#)

4-725-901-11(2) Copyright 2017 Sony Corporation

Digital Still Camera  
DSC-RX10M4

## Airplane Mode

---

When you board an airplane, etc., you can temporarily disable all the wireless-related functions including Wi-Fi.

**1** MENU →  (Network) → [Airplane Mode] → **desired setting.**

If you set [Airplane Mode] to [On], an airplane mark will be displayed on the screen.



Digital Still Camera  
DSC-RX10M4

## Wi-Fi Settings: WPS Push

---

If your access point has a Wi-Fi Protected Setup (WPS) button, you can register the access point to this product easily.

- 1 **MENU** →  **(Network)** → **[Wi-Fi Settings]** → **[WPS Push]**.
- 2 **Push the Wi-Fi Protected Setup (WPS) button on the access point to connect.**

### Note

- [WPS Push] works only if the security setting of your access point is set to WPA or WPA2 and your access point supports the Wi-Fi Protected Setup (WPS) button method. If the security setting is set to WEP or your access point does not support the Wi-Fi Protected Setup (WPS) button method, perform [Access Point Set].
- For details about the available functions and settings of your access point, see the access point operating instructions or contact the administrator of the access point.
- A connection may not be possible or the communication distance may be shorter depending on the surrounding conditions, such as the type of wall material and the presence of obstructions or radio waves between the product and access point. In this case, change the location of the product or move the product closer to the access point.

---

### Related Topic

- [Wi-Fi Settings: Access Point Set.](#)

## Wi-Fi Settings: Access Point Set.

You can register your access point manually. Before starting the procedure, check the SSID name of the access point, security system, and password. The password may be preset in some devices. For details, see the access point operating instructions, or consult the access point administrator.

1 MENU →  (Network) → [Wi-Fi Settings] → [Access Point Set.].

2 Select the access point you want to register.

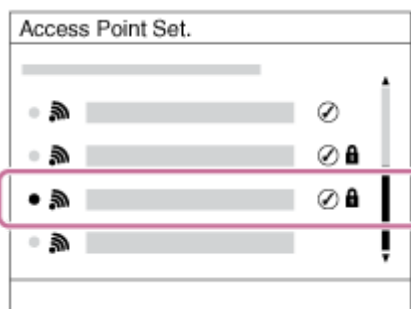

**When the desired access point is displayed on the screen:** Select the desired access point.

**When the desired access point is not displayed on the screen:** Select [Manual Setting] and set the access point.

- If you select [Manual Setting], input the SSID name of the access point, then select the security system.

3 Input the password, and select [OK].

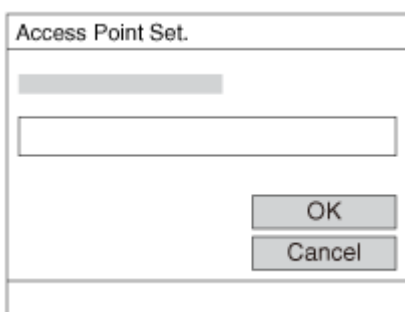

- Access points without the  mark do not require a password.

4 Select [OK].

### Other setting items

Depending on the status or the setting method of your access point, you may want to set more items.

#### WPS PIN:

Displays the PIN code you enter into the connected device.

#### Priority Connection:

Select [On] or [Off].

#### IP Address Setting:

Select [Auto] or [Manual].

**IP Address:**

If you are entering the IP address manually, enter the set address.

**Subnet Mask/Default Gateway:**

If you have set [IP Address Setting] to [Manual], enter each address according to your network environment.

**Note**

- To give the registered access point priority in the future, set [Priority Connection] to [On].

---

**Related Topic**

- [Wi-Fi Settings: WPS Push](#)
- [How to use the keyboard](#)

Digital Still Camera  
DSC-RX10M4

## Wi-Fi Settings: Disp MAC Address

---

Displays the MAC address of this product.

**1** MENU →  (Network) → [Wi-Fi Settings] → [Disp MAC Address].

Digital Still Camera  
DSC-RX10M4

## Wi-Fi Settings: SSID/PW Reset

---

This product shares the connection information for [Send to Smartphone] and [  Connection] with a device that has permission to connect. If you want to change the device that is permitted to connect, reset the connection information.

1 MENU →  (Network) → [Wi-Fi Settings] → [SSID/PW Reset] → [OK].

### Note

- If you connect this product to a smartphone after resetting the connection information, you must make the settings for the smartphone again.

---

### Related Topic

- [Snd to Smrtphn Func: Send to Smartphone](#)
- [Ctrl w/ Smartphone](#)

Digital Still Camera  
DSC-RX10M4

## Edit Device Name

---

You can change the device name for the Wi-Fi Direct or Bluetooth connection.

- 1 MENU →  (Network) → [Edit Device Name].**
- 2 Select the input box, then input the device name→[OK].**

---

### Related Topic

- [Wi-Fi Settings: WPS Push](#)
- [Wi-Fi Settings: Access Point Set.](#)
- [How to use the keyboard](#)

Digital Still Camera  
DSC-RX10M4

## Reset Network Set.

---

Resets all the network settings to default settings.

**1** MENU →  (Network) → [Reset Network Set.] → [Enter].

Digital Still Camera  
DSC-RX10M4

## Recommended computer environment

---

You can confirm the operating computer environment of the software from the following URL:

<http://www.sony.net/pcenv/>



Digital Still Camera  
DSC-RX10M4

## Software for Mac computers

---

For details on software for Mac computers, access the following URL:

<http://www.sony.co.jp/imsoft/Mac/>

### Note

- The software that can be used varies depending on the region.

---

### Related Topic

- [Send to Computer](#)

Digital Still Camera  
DSC-RX10M4

## PlayMemories Home

---

With PlayMemories Home, you can do the following:

- You can import images shot with this product to your computer.
- You can play back the images imported to your computer.
- You can share your images using PlayMemories Online.
- You can edit movies such as by cutting or merging.
- You can add various effects such as BGM and subtitles to movies.
- You can change the playback speed of movies and slow-motion movies.

Also for Windows, you can do the following:

- You can organize images on the computer on a calendar by shooting date to view them.
- You can edit and correct images, such as by trimming and resizing.
- You can create a disc from movies imported to a computer.  
Blu-ray discs or AVCHD discs can be created from XAVC S-format movies.
- You can upload images to a network service. (An Internet connection is required.)
- You can import images recorded with location information to a computer and view them on a map.
- For other details, please refer to the Help of PlayMemories Home.

---

### Related Topic

- [Installing PlayMemories Home](#)

## Installing PlayMemories Home

- 1 Using your computer's Internet browser, go to the URL below and download PlayMemories Home by following the on-screen instructions.

<http://www.sony.net/pm/>

- An Internet connection is required.
- For detailed instructions, visit the PlayMemories Home support page (English only).  
<http://www.sony.co.jp/pmh-se/>

- 2 Connect the product to your computer using the micro USB cable (supplied), then turn the product on.

- New functions may be added to PlayMemories Home. Even if PlayMemories Home has already been installed on your computer, connect this product and your computer again.
- Do not remove the micro USB cable (supplied) from the camera while the camera is in operation or the access screen is displayed. Doing so may damage the data.

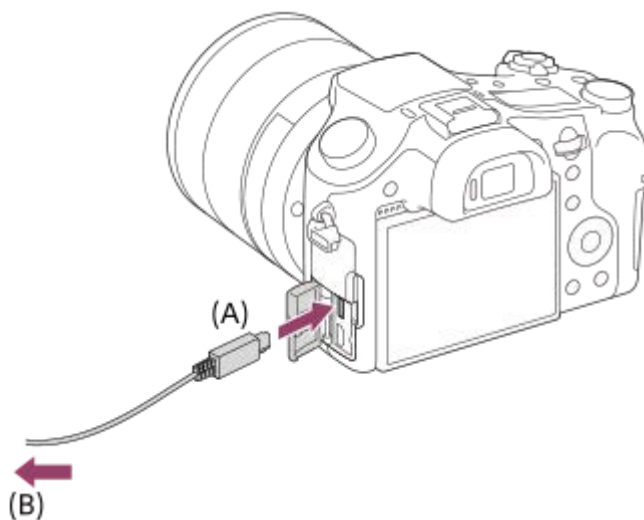

**A:** To the Multi/Micro USB Terminal  
**B:** To the USB jack of the computer

### Note

- Log on as Administrator.
- It may be necessary to restart your computer. When the restart confirmation message appears, restart the computer following the instructions on the screen.
- DirectX may be installed depending on your computer's system environment.

## Connecting to a computer

- 1 Insert a sufficiently charged battery pack into the camera, or connect the camera to a wall outlet (wall socket) using an AC Adaptor (sold separately).
- 2 Turn on the camera and the computer.
- 3 Check that [USB Connection] under  (Setup) is set to [Mass Storage].
- 4 Connect the camera to the computer using the micro USB cable (supplied) (A).

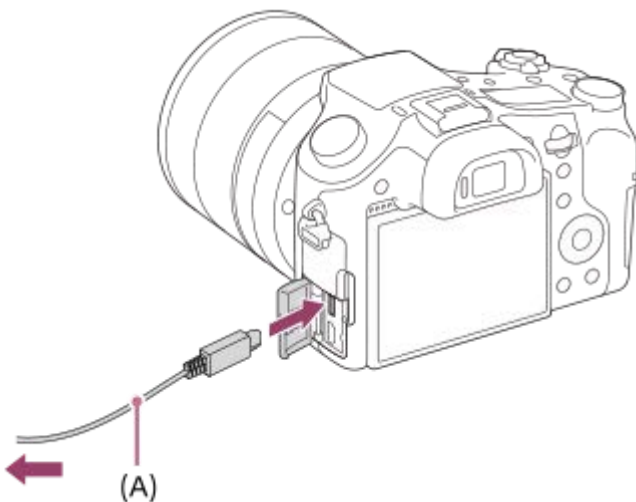

- When you connect the camera to the computer for the first time, the procedure for recognizing the camera may start automatically on the computer. Wait until the procedure is finished.
- If you connect the product to your computer using the micro USB cable when [USB Power Supply] is set to [On], power is supplied from your computer. (Default setting: [On])

### Related Topic

- [USB Connection](#)
- [USB LUN Setting](#)

Digital Still Camera  
DSC-RX10M4

## Importing images to the computer without using PlayMemories Home

---

PlayMemories Home allows you to easily import images. For details on PlayMemories Home functions, see the Help of PlayMemories Home.

### Importing images to the computer without using PlayMemories Home (For Windows)

When the AutoPlay Wizard appears after making a USB connection between this product and a computer, click [Open folder to view files] → [OK] → [DCIM]. Then copy the desired images to the computer.

### Importing images to the computer without using PlayMemories Home (For Mac)

Connect the product to your Mac computer. Double-click the newly recognized icon on the desktop → the folder in which the image you want to import is stored. Then drag and drop the image file on to the hard disk icon.

#### Note

- For operations such as importing XAVC S movies or AVCHD movies to the computer, use PlayMemories Home.
- Do not edit or otherwise process AVCHD or XAVC S movie files/folders from the connected computer. Movie files may be damaged or become unplayable. Do not delete or copy AVCHD movies or XAVC S movies on the memory card from the computer. Sony is not held liable for consequences resulting from such operations via the computer.

Digital Still Camera  
DSC-RX10M4

## Disconnecting the camera from the computer

---

Perform steps 1 and 2 below before performing the following operations:

- Disconnecting the micro USB cable.
- Removing a memory card.
- Turning off the product.

**1** Click  (Safely Remove Hardware and Eject Media ) in the taskbar.

**2** Click the displayed message.

### Note

- On Mac computers, drag and drop the memory card icon or the drive icon into the “Trash” icon. The camera will be disconnected from the computer.
- On Windows 7/Windows 8 computers, the disconnection icon may not appear. In that case, you can skip the steps above.
- Do not remove the micro USB cable from the camera while the access lamp is lit. The data may be damaged.

Digital Still Camera  
DSC-RX10M4

## Image Data Converter

---

With Image Data Converter, you can do the following:

- You can develop and edit images recorded in RAW format with various corrections, such as tone curve and sharpness.
  - You can adjust images with white balance, exposure, and [Creative Style], etc.
  - You can save the still images displayed and edited on a computer.  
You can either save the still image as RAW format or save it in the general file format.
  - You can display and compare the RAW images and JPEG images recorded by this product.
  - You can rank images in five grades.
  - You can apply color labels.
- 

### Related Topic

- [Installing Image Data Converter](#)

Digital Still Camera  
DSC-RX10M4

## Installing Image Data Converter

---

- 1 Download and install the software by accessing the following URL.

**Windows**

<http://www.sony.co.jp/imsoft/Win/>

**Mac**

<http://www.sony.co.jp/imsoft/Mac/>

**Note**

- Log on as Administrator.



Digital Still Camera  
DSC-RX10M4

## Remote Camera Control

---

When using Remote Camera Control, the following operations are available on your computer.

- Changing this product's settings and shooting.
- Recording images directly to the computer.
- Performing interval timer shooting.

Use these functions after selecting MENU →  (Setup) → [USB Connection] → [PC Remote]. For details on how to use Remote Camera Control, refer to the Help.

---

### Related Topic

- [Installing Remote Camera Control](#)
- [USB Connection](#)
- [PC Remote Settings: Still Img. Save Dest.](#)
- [PC Remote Settings: RAW+J PC Save Img](#)

Digital Still Camera  
DSC-RX10M4

## Installing Remote Camera Control

---

Download and install the software by accessing the following URL:

**Windows:**

<http://www.sony.co.jp/imsoft/Win/>

**Mac:**

<http://www.sony.co.jp/imsoft/Mac/>

Digital Still Camera  
DSC-RX10M4

## Selecting a disc to be created

You can create a disc that can be played back on other devices from a movie recorded on this camera. What devices can play back the disc depends on the disc type. Select a disc type suitable for the playback devices you will be using.

Depending on the movie type, the movie format may be converted when creating a disc.



### High-definition image quality (HD) (Blu-ray Disc)

High-definition image quality (HD) movies can be recorded on a Blu-ray Disc, creating a high-definition image quality (HD) disc.

A Blu-ray Disc enables you to record longer-duration high-definition image quality (HD) movies than DVD discs.

Writable movie formats: XAVC S, AVCHD

Players: Blu-ray Disc playback devices (Sony Blu-ray Disc players, PlayStation 3, etc.)



### High-definition image quality (HD) (AVCHD recording disc)

High-definition image quality (HD) movies can be recorded on DVD media such as DVD-R discs, creating a high-definition image quality (HD) disc.

Writable movie formats: XAVC S, AVCHD

Players: AVCHD format playback devices (Sony Blu-ray Disc players, PlayStation 3, etc.)

You cannot play these kinds of discs on ordinary DVD players.



### Standard definition image quality (STD)

Standard definition image quality (STD) movies converted from high-definition image quality (HD) movies can be recorded on DVD media such as DVD-R discs, creating a standard image quality (STD) disc.

Writable movie formats: AVCHD

Players: Ordinary DVD playback devices (DVD players, computers that can play back DVD discs, etc.)

#### Hint

- You can use the following types of 12 cm discs with PlayMemories Home.  
**BD-R/DVD-R/DVD+R/DVD+R DL:** Non-rewritable  
**BD-RE/DVD-RW/DVD+RW:** Rewritable  
Additional recording is not possible.
- Always maintain your "PlayStation 3" to use the latest version of the "PlayStation 3" system software.

#### Note

- 4K movies cannot be recorded on a disc in 4K image quality.

#### Related Topic

- [Creating Blu-ray Discs from high-definition image quality movies](#)
- [Creating DVD discs \(AVCHD recording discs\) from high-definition image quality movies](#)

- [Creating DVD discs from standard image quality movies](#)

4-725-901-11(2) Copyright 2017 Sony Corporation

Digital Still Camera  
DSC-RX10M4

## Creating Blu-ray Discs from high-definition image quality movies

---

You can create Blu-ray Discs that can be played back on Blu-ray Disc playback devices (such as Sony Blu-ray Disc players or the PlayStation 3, etc.).

### A. How to create using a computer

With a Windows computer, you can copy movies imported to the computer and create Blu-ray Discs using PlayMemories Home.

Your computer must be able to create Blu-ray Discs.

When you create a Blu-ray Disc for the first time, connect your camera to the computer using a USB cable. The necessary software is automatically added to your computer. (An Internet connection is needed.)

For details on how to create a disc using PlayMemories Home, refer to the Help guide for PlayMemories Home.

### B. How to create using a device other than a computer

You can also create Blu-ray Discs using a Blu-ray recorder, etc.

For details, refer to the device's operating instructions.

#### Note

- When creating Blu-ray discs using PlayMemories Home from movies recorded in the XAVC S movie format, the image quality is converted to 1920×1080 (60i/50i). It is not possible to create discs with the original image quality. To record movies with the original image quality, copy movies to a computer or an external medium.

---

#### Related Topic

- [Selecting a disc to be created](#)
- [Creating DVD discs \(AVCHD recording discs\) from high-definition image quality movies](#)
- [Creating DVD discs from standard image quality movies](#)

Digital Still Camera  
DSC-RX10M4

## Creating DVD discs (AVCHD recording discs) from high-definition image quality movies

You can create DVD discs (AVCHD recording discs) that can be played back on AVCHD-compatible playback devices (such as Sony Blu-ray Disc players or the PlayStation 3, etc.).

### A. How to create using a computer

With a Windows computer, you can copy movies imported to the computer and create DVD discs (AVCHD recording discs) using PlayMemories Home.

Your computer must be able to create DVD discs (AVCHD recording discs).

When you create a DVD disc for the first time, connect your camera to the computer using a USB cable. The necessary software is automatically added to your computer. (An Internet connection is needed.)

For details on how to create a disc using PlayMemories Home, refer to the Help guide for PlayMemories Home.

### B. How to create using a device other than a computer

You can also create DVD discs (AVCHD recording discs) using a Blu-ray recorder, etc.

For details, refer to the device's operating instructions.

#### Note

- When creating DVD discs (AVCHD recording discs) using PlayMemories Home from movies recorded in the XAVC S movie format, the image quality is converted to 1920×1080 (60i/50i). It is not possible to create discs with the original image quality. To record movies with the original image quality, copy movies to a computer or an external medium.
- When creating AVCHD recording discs using PlayMemories Home from movies recorded in the AVCHD movie format with [Record Setting] set to [60i 24M(FX)]/[50i 24M(FX)], the image quality is converted and it is not possible to create discs with the original image quality. This conversion can take a long time. To record movies with the original image quality, use a Blu-ray Disc.

#### Related Topic

- [Selecting a disc to be created](#)
- [Creating Blu-ray Discs from high-definition image quality movies](#)
- [Creating DVD discs from standard image quality movies](#)

Digital Still Camera  
DSC-RX10M4

## Creating DVD discs from standard image quality movies

---

You can create DVD discs that can be played back on ordinary DVD playback devices (DVD players, computers that can play back DVD discs, etc.).

### **A. How to create using a computer**

With a Windows computer, you can copy movies imported to the computer and create DVD disc using PlayMemories Home.

Your computer must be able to create DVD discs.

When you create a DVD disc for the first time, connect your camera to the computer using a USB cable. Install the dedicated add-on software following the on-screen instructions. (An internet connection is needed.)

For details on how to create a disc using PlayMemories Home, refer to the Help for PlayMemories Home.

### **B. How to create using a device other than a computer**

You can also create DVD discs using a Blu-ray recorder, HDD recorder, etc.

For details, refer to the device's operating instructions.

---

### **Related Topic**

- [Selecting a disc to be created](#)
- [Creating Blu-ray Discs from high-definition image quality movies](#)
- [Creating DVD discs \(AVCHD recording discs\) from high-definition image quality movies](#)

## Using MENU items

You can change settings related to all the camera operations including shooting, playback, and operating method. You can also execute camera functions from the MENU.

- 1 Press the MENU button to display the menu screen.

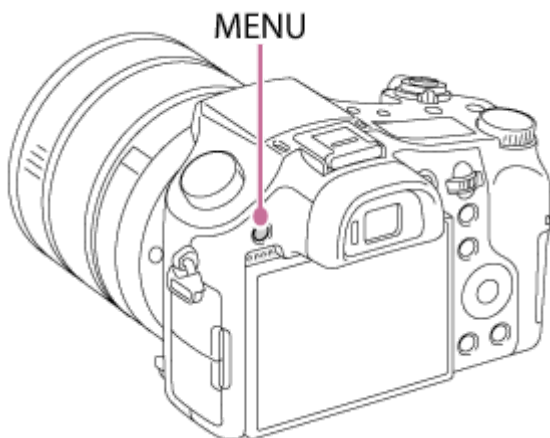

- 2 Select the desired setting you want to adjust using the top/bottom/left/right sides of the control wheel or by turning the control wheel, and then press the center of the control wheel.
  - Select an icon at the top of the screen (A) and press the left/right side of the control wheel to move to another MENU item.
  - You can go back to the previous screen by pressing the MENU button (B).

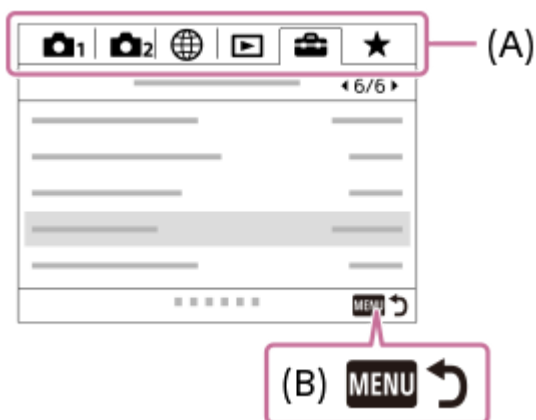

- 3 Select the desired setting value, and press the center to confirm your selection.

### Related Topic

- [Tile Menu](#)





Digital Still Camera  
DSC-RX10M4

## Quality (still image)

1 MENU →  (Camera Settings1) → [ Quality] → desired setting.

### Menu item details

#### RAW:

File format: RAW (records in the compressed RAW format)

Digital processing is not performed on this file format. Select this format to process images on a computer for professional purposes.

- The image size is fixed to the maximum size. The image size is not displayed on the screen.

#### RAW & JPEG:

File format: RAW (records in the compressed RAW format) + JPEG

A RAW image and a JPEG image are created at the same time. This is suitable when you need 2 image files, a JPEG for viewing, and a RAW for editing. The JPEG image quality is set to [Fine].

#### Extra fine:

File format: JPEG

The image is compressed in the JPEG format and recorded using a higher quality than with [Fine].

#### Fine:

File format: JPEG

The image is compressed in the JPEG format when recorded.

#### Standard:

File format: JPEG

The image is compressed in the JPEG format when recorded. Since the compression rate of [Standard] is higher than that of [Fine], the file size of [Standard] is smaller than that of [Fine]. This will allow more files to be recorded on one memory card, but the image quality will be lower.

### About RAW images

- To open a RAW image file recorded with this camera, the software Image Data Converter is needed. With Image Data Converter, you can open a RAW image file, then convert it into a popular image format such as JPEG or TIFF, or readjust the white balance, saturation or contrast of the image.
- You cannot apply [Auto HDR] or [Picture Effect] functions with RAW images.



#### Note

- If you do not intend to edit the images on your computer, we recommend that you record in JPEG format.
- You cannot add DPOF (print order) registration marks to RAW images.

Digital Still Camera  
DSC-RX10M4

## Image Size (still image)

The larger the image size, the more detail will be reproduced when the image is printed on large-format paper. The smaller the image size, the more images can be recorded.

1 MENU →  (Camera Settings1) → [ Image Size] → desired setting.

### Menu item details

[  Aspect Ratio] is set to [3:2]	
L: 20M	5472×3648 pixels
M: 10M	3888×2592 pixels
S: 5.0M	2736×1824 pixels

[  Aspect Ratio] is set to [4:3]	
L: 18M	4864×3648 pixels
M: 10M	3648×2736 pixels
S: 5.0M	2592×1944 pixels
VGA	640×480 pixels

[  Aspect Ratio] is set to [16:9]	
L: 17M	5472×3080 pixels
M: 7.5M	3648×2056 pixels
S: 4.2M	2720×1528 pixels

[  Aspect Ratio] is set to [1:1]	
L: 13M	3648×3648 pixels
M: 6.5M	2544×2544 pixels
S: 3.7M	1920×1920 pixels

#### Note

- When [ Quality] is set to [RAW] or [RAW & JPEG], the image size for RAW images corresponds to "L."



- Aspect Ratio (still image)

4-725-901-11(2) Copyright 2017 Sony Corporation

Digital Still Camera  
DSC-RX10M4

## Aspect Ratio (still image)

---

1 MENU →  1 (Camera Settings1) → [ Aspect Ratio] → desired setting.

### Menu item details

**3:2:**

Same aspect ratio as 35 mm plate film

**4:3:**

An aspect ratio suitable for viewing on a TV that does not support high definition

**16:9:**

An aspect ratio suitable for viewing on a TV that supports high definition

**1:1:**

The horizontal and vertical ratio is equal.

Digital Still Camera  
DSC-RX10M4

## Panorama: Size

---

Sets the image size when shooting panoramic images. The image size varies depending on the [Panorama: Direction] setting.

1 MENU →  (Camera Settings1) → [Panorama: Size] → desired setting.

### Menu item details

When [Panorama: Direction] is set to [Up] or [Down]

**Standard:** 3872×2160

**Wide:** 5536×2160

When [Panorama: Direction] is set to [Left] or [Right]

**Standard:** 8192×1856

**Wide:** 12416×1856

---

### Related Topic

- [Sweep Panorama](#)
- [Panorama: Direction](#)

Digital Still Camera  
DSC-RX10M4

## Panorama: Direction

---

Sets the direction to pan the camera when shooting panoramic images.

**1** MENU →  1 (Camera Settings1) → [Panorama: Direction] → desired setting.

### Menu item details

**Right:**

Pan the camera from the left to the right.

**Left:**

Pan the camera from the right to the left.

**Up:**

Pan the camera from the bottom to the top.

**Down:**

Pan the camera from the top to the bottom.

---



### Related Topic

- [Sweep Panorama](#)

Digital Still Camera  
DSC-RX10M4

## Long Exposure NR (still image)

When you set the shutter speed to 1/3 second(s) or longer (long exposure shooting), noise reduction is turned on for the duration that the shutter is open. With the function turned on, the grainy noise typical of long exposures is reduced.

1 MENU →  (Camera Settings1) → [ Long Exposure NR] → desired setting.

### Menu item details





#### On:

Activates noise reduction for the same duration that the shutter is open. When noise reduction is in progress, a message appears and you cannot take another picture. Select this to prioritize the image quality.

#### Off:

Does not activate noise reduction. Select this to prioritize the timing of shooting.

#### Note



- [ Long Exposure NR] is not available when [ Shutter Type] is set to [Electronic Shut.].
- Noise reduction may not be activated even if [ Long Exposure NR] is set to [On] in the following situations:
  - The shooting mode is set to [Sweep Panorama].
  - [Drive Mode] is set to [Cont. Shooting] or [Cont. Bracket].
  - The shooting mode is set to [Scene Selection] and [Sports Action], [Hand-held Twilight] or [Anti Motion Blur] is selected.
  - The ISO sensitivity is set to [Multi Frame NR].
- [ Long Exposure NR] cannot be set to [Off] in the following shooting modes:
  - [Intelligent Auto]
  - [Superior Auto]
  - [Scene Selection]
- Depending on the shooting conditions, the camera may not perform noise reduction, even if the shutter speed is 1/3 second(s) or longer.



Digital Still Camera  
DSC-RX10M4

## High ISO NR (still image)

When shooting with high ISO sensitivity, the product reduces noise that becomes more noticeable when the product sensitivity is high.

1 MENU →  1 (Camera Settings1) → [ High ISO NR] → desired setting.

### Menu item details

**Normal:**

Activates high ISO noise reduction normally.





**Low:**

Activates high ISO noise reduction moderately.

**Off:**

Does not activate high ISO noise reduction. Select this to prioritize the timing of shooting.



**Note**

- [ High ISO NR] is not available in the following shooting modes:
  - [Intelligent Auto]
  - [Superior Auto]
  - [Scene Selection]
  - [Sweep Panorama]
- When [ Quality] is set to [RAW], this function is not available.
- [ High ISO NR] does not work for RAW images when the [ Quality] is [RAW & JPEG].

Digital Still Camera  
DSC-RX10M4

## Color Space (still image)

The way colors are represented using combinations of numbers or the range of color reproduction is called “color space.” You can change the color space depending on the purpose of the image.

1 MENU →  (Camera Settings1) → [ Color Space] → desired setting.

### Menu item details

#### sRGB:

This is the standard color space of the digital camera. Use [sRGB] in normal shooting, such as when you intend to print out the images without any modification.

#### AdobeRGB:

This color space has a wide range of color reproduction. When a large part of the subject is vivid green or red, Adobe RGB is effective. The file name of the recorded image starts with “\_.”

#### Note

- [AdobeRGB] is for applications or printers that support color management and DCF2.0 option color space. Images may not be printed or viewed in the correct colors if you use applications or printers that do not support Adobe RGB.
- When displaying images that were recorded with [AdobeRGB] on non-Adobe RGB-compliant devices, the images will be displayed with low saturation.

Digital Still Camera  
DSC-RX10M4

## Switching the auto mode (Auto Mode)

This camera is equipped with the following two automatic shooting modes: [Intelligent Auto] and [Superior Auto]. You can switch the auto mode to shoot according to the subject and your preferences.

- 1 Set the mode dial to **AUTO**.
- 2 MENU →  1 (Camera Settings1) → [Auto Mode] → desired setting.

### Menu item details



#### Intelligent Auto:

Allows you to shoot with automatic scene recognition.

#### Superior Auto:

Allows you to shoot with automatic scene recognition. This mode takes clear images of dark or backlit scenes.

#### Note

- In [Superior Auto] mode, the recording process takes longer, since the product creates a composite image. In this case, the  (overlay icon) is displayed and the shutter sound is heard multiple times, but only one image is recorded.
- In [Superior Auto] mode and when the  (overlay icon) is displayed, be sure not to move the camera before the multiple shots are recorded.
- For [Intelligent Auto] and [Superior Auto] mode, most of the functions are set automatically, and you cannot adjust the settings on your own.

### Related Topic

- [Intelligent Auto](#)
- [Superior Auto](#)

Digital Still Camera  
DSC-RX10M4

## Scene Selection

---

Allows you to shoot with preset settings according to the scene.

- 1 Set the mode dial to SCN (Scene Selection).
- 2 Turn the control dial to select the desired setting.

### Menu item details

#### Portrait:

Blurs background and sharpens the subject. Accentuates the skin tones softly.



#### Sports Action:

Shoots a moving subject at a fast shutter speed so that the subject looks as if it is standing still. The product shoots images continuously while the shutter button is pressed.



#### Macro:

Shoots close-ups of the subjects, such as flowers, insects, food, or small items.



#### Landscape:

Shoots the entire range of a scenery in sharp focus with vivid colors.



#### Sunset:

Shoots the red of the sunset beautifully.



### 🌙 Night Scene:

Shoots night scenes without losing the dark atmosphere.



### 👋 Hand-held Twilight:

Shoots night scenes with less noise and blur without using a tripod. A burst of shots are taken, and image processing is applied to reduce subject blur, camera-shake, and noise.



### 👤🌙 Night Portrait:

Shoots night scene portraits using the flash.

The flash does not pop up automatically. Pop up the flash manually before shooting.



### 👤👤 Anti Motion Blur:

Allows you to shoot indoor shots without using the flash and reduces subject blur. The product shoots burst images and combines them to create the image, reducing subject blur and noise.



#### Note

- Under the following settings, the shutter speed is slower, so use of a tripod is recommended to prevent the image from blurring:
  - [Night Scene]
  - [Night Portrait]
- In the [Hand-held Twilight] or [Anti Motion Blur] mode, the shutter clicks 4 times and an image is recorded.
- If you select [Hand-held Twilight] or [Anti Motion Blur] with [RAW] or [RAW & JPEG], the image quality becomes [Fine] temporarily.
- Reducing blur is less effective even in [Hand-held Twilight] or [Anti Motion Blur] when shooting the following subjects:
  - Subjects with erratic movement.
  - Subjects that are too close to the product.
  - Subjects with continuously similar patterns, such as the sky, a beach, or a lawn.
  - Subjects with constant change such as waves or water falls.

- In the case of [Hand-held Twilight] or [Anti Motion Blur], block noise may occur when using a light source that flickers, such as fluorescent lighting.
- The minimum distance that you can come close to a subject does not change even if you select [Macro]. For the minimum in-focus range, refer to the minimum distance of the lens attached to the product.

#### Hint

- To change the scene, rotate the control dial on the shooting screen and select a new scene.

---

#### Related Topic

- [Using flash](#)

4-725-901-11(2) Copyright 2017 Sony Corporation

Digital Still Camera  
DSC-RX10M4

## Drive Mode

Select the appropriate mode for the subject, such as single shooting, continuous shooting or bracketing shooting.

1 MENU →  (Camera Settings1) → [Drive Mode] → desired setting.

2 Select the desired mode using the right/left side of the control wheel.

### Menu item details

#### Single Shooting:

Normal shooting mode.

#### Cont. Shooting:

Shoots images continuously while you press and hold down the shutter button.

#### Self-timer:

Shoots an image using the self-timer after a designated number of seconds have elapsed since the shutter button was pressed.

#### Self-timer(Cont):

Shoots a designated number of images using the self-timer after a designated number of seconds have elapsed since the shutter button was pressed.

#### BRK C Cont. Bracket:

Shoots images while holding the shutter button down, each with different degrees of exposure.

#### BRK S Single Bracket:

Shoots a specified number of images, one by one, each with a different degrees of exposure.

#### BRK WB WB bracket:

Shoots a total of three images, each with different color tones according to the selected settings for white balance, color temperature and color filter.

#### BRK DRO DRO Bracket:

Shoots a total of three images, each at a different degree of D-Range Optimizer.

#### Note

- When the shooting mode is set to [Scene Selection] and [Sports Action] is selected, [Single Shooting] cannot be performed.

### Related Topic

- [Cont. Shooting](#)
- [Self-timer](#)
- [Self-timer\(Cont\)](#)
- [Cont. Bracket](#)
- [Single Bracket](#)
- [WB bracket](#)
- [DRO Bracket](#)

Digital Still Camera  
DSC-RX10M4

## Bracket Settings

---

You can set the self-timer in bracket shooting mode, and the shooting order for exposure bracketing and white balance bracketing.

1 MENU →  1 (Camera Settings1) → [Drive Mode] → select bracket shooting mode.

2 MENU →  1 (Camera Settings1) → [Bracket Settings] → desired setting.

### Menu item details

#### Selftimer during Brkt:

Sets whether to use the self-timer during bracket shooting. Also sets the number of seconds until the shutter is released if using the self-timer.

(OFF/2 Sec/5 Sec/10 Sec)

#### Bracket order:

Sets the order of exposure bracketing and white balance bracketing.

(0→-→+/-→0→+)



---



### Related Topic

- [Cont. Bracket](#)
- [Single Bracket](#)
- [WB bracket](#)
- [DRO Bracket](#)



## Recall (Camera Settings1/Camera Settings2)



Allows you to shoot an image after recalling often-used modes or camera settings registered with [1/2 Memory] in advance.

- 1 **Set the mode dial to MR (Memory recall).**
- 2 **Press the left/right side of the control wheel or turn the control wheel to select the desired number, then press the center of the control wheel.**
  - You can also recall registered modes or settings by selecting MENU → 1 (Camera Settings1) → [1/2 Recall].

### Hint

- To recall settings registered to the memory card, set the mode dial to MR (Memory recall), then select the desired number by pressing the left/right side of the control wheel.
- Settings registered to a memory card using another camera of the same model name can be recalled with this camera.

### Note

- If you set [1/2 Recall] after completing the shooting settings, the registered settings are given priority and the original settings may become invalid. Check the indicators on the screen before shooting.



### Related Topic

- [Memory \(Camera Settings1/Camera Settings2\)](#)

Digital Still Camera  
DSC-RX10M4

## Memory (Camera Settings1/Camera Settings2)

Allows you to register up to 3 often-used modes or product settings to the product and up to 4 (M1 through M4) to the memory card. You can recall the settings using just the mode dial.

- 1 Set the product to the setting you want to register.
- 2 MENU →  1 (Camera Settings1) → [ 1 /  2 Memory] → desired number.
- 3 Press the center of the control wheel to confirm.

### Items that can be registered

- You can register various functions for shooting. The items that can actually be registered are displayed on the menu of the camera.
- Shutter speed
- Optical zoom scale

### To change registered settings

Change the setting to the desired one and re-register the setting to the same mode number.

#### Note



- M1 through M4 can be selected only when a memory card is inserted into the product.
- Program Shift cannot be registered.
- For some functions, the position of the dial and the setting actually used for shooting may not match. If this happens, shoot images by referring to the information displayed on the monitor.

### Related Topic

- [Recall \(Camera Settings1/Camera Settings2\)](#)

## Registering shooting settings to a custom key (Reg Cust Shoot Set)

You can register shooting settings (such as exposure, focus setting, drive mode, etc.) to a custom key in advance and temporarily recall them while holding down the key. Simply press the custom key to switch the settings quickly and release the key to go back to the original settings. This function is useful when recording active scenes such as sports.

- 1 **MENU** →  **1 (Camera Settings1)** → **[Reg Cust Shoot Set]** → **Select a registration number from [Recall Custom hold 1] to [Recall Custom hold 3].**  
 The setting screen for the selected number will be displayed.
- 2 **Using the top/bottom/left/right side of the control wheel, select the check boxes for the functions that you want to recall with one of the registration numbers and press the center to check each box.**  
 A  mark will be displayed in the boxes for the functions.
  - To cancel a selection, press the center again.
- 3 **Select the function that you want to adjust using the top/bottom/left/right side of the control wheel, and press the center to adjust the function to the desired setting.**
  - Select [Import Current Setting] to register the current settings of the camera to the registration number that you chose.
- 4 **Select [Register].**

### Items that can be registered

- You can register various functions for shooting. The items that can actually be registered are displayed on the menu of the camera.
- Exposure
- Focus setting
- Drive mode (other than self-timer)

### To recall registered settings

1. **MENU** →  **2 (Camera Settings2)** → **[Custom Key(Shoot.)]** → Select the desired key and then select one of the registration numbers from [Recall Custom hold 1] to [Recall Custom hold 3].
2. On the shooting screen, press the shutter button while holding down the key to which you assigned one of the registration numbers.  
 The registered settings are activated while you are holding down the custom key.

#### Hint

- You can change the settings for [Reg Cust Shoot Set] after assigning one of the registration numbers to the custom key using [Custom Key(Shoot.)].

#### Note

- The registration numbers [Recall Custom hold 1] through [Recall Custom hold 3] are available only when the shooting mode is set to P/A/S/M.
- Depending on the status of the camera when registered settings are recalled, the registered settings may not take effect.

---

---

## Related Topic

- [Custom Key\(Shoot.\)/Custom Key\(PB\)](#)

4-725-901-11(2) Copyright 2017 Sony Corporation

Digital Still Camera  
DSC-RX10M4

## Focus Area

Selects the focusing area. Use this function when it is difficult to focus properly in the auto focus mode.

1 MENU →  (Camera Settings1) → [Focus Area] → desired setting.

### Menu item details

#### Wide :

Focuses on a subject covering the whole range of the screen automatically. When you press the shutter button halfway down in the still image shooting mode, a green frame is displayed around the area that is in focus.

#### Center :

Focuses automatically on a subject in the center of the image. Use together with the focus-lock function to create the composition you want.

#### Flexible Spot :

Allows you to move the focusing frame to a desired point on the screen and focus on an extremely small subject in a narrow area.

On the Flexible Spot shooting screen, you can change the size of the focusing frame by turning the control wheel.

#### Expand Flexible Spot :

If the product cannot focus on a single selected point, it uses focus points around the flexible spot as a secondary priority area for focusing.



#### Lock-on AF :

When the shutter button is pressed and held halfway down, the product tracks the subject within the selected autofocus area. This setting is available only when the focus mode is set to [Continuous AF]. Point the cursor at [Lock-on AF] on the [Focus Area] setting screen, and then select the desired area to start tracking using the left/right sides of the control wheel. You can also move the tracking start area to the desired point by designating the area as a flexible spot or expand flexible spot. On the Flexible Spot shooting screen, you can change the size of the focusing frame by turning the control wheel.

### To move the focus area

- When [Focus Area] is set to [Flexible Spot] or [Expand Flexible Spot], if pressing the button to which [Focus Standard] is assigned, you can shoot while moving the focusing frame using the top/bottom/left/right sides of the control wheel. To change the shooting settings using the control wheel, press the button to which [Focus Standard] is assigned.
- You can move the focusing frame quickly by touching and dragging it on the monitor. Set [Touch Operation] to other than [Off] beforehand.

#### Note

- [Focus Area] is locked to [Wide] in the following situations:
  - [Intelligent Auto]
  - [Superior Auto]
  - [Scene Selection]
  - During Smile Shutter mode
  - The mode dial is set to  (Movie) and [Auto Dual Rec] is set to [On].
- The focus area may not light up during continuous shooting or when the shutter button is pressed all the way down at once.
- When the mode dial is set to  (Movie) or during movie shooting, [Lock-on AF] cannot be selected as the [Focus Area].
- You cannot perform functions assigned to the control wheel or the custom button 3 while moving the focusing frame.

---

---

## Related Topic



- [Touch Operation](#)
- [Adjusting the focus area settings to the camera's orientation \(horizontal/vertical\) \(Sw. V/H AF Area\)](#)
- [Registering the current focus area \(AF Area Regist.\)](#)

4-725-901-11(2) Copyright 2017 Sony Corporation

Digital Still Camera  
DSC-RX10M4

## Adjusting the focus area settings to the camera's orientation (horizontal/vertical) (Sw. V/H AF Area)

You can set whether to switch the [Focus Area] and the position of the focusing frame according to the orientation of the camera (horizontal/vertical). This function is useful when shooting scenes for which you have to change the camera position frequently, such as portraits or sports scenes.

1 MENU →  (Camera Settings1) → [ Swt. V/H AF Area] → desired setting.

### Menu item details

#### Off:

Does not switch the [Focus Area] and the position of the focusing frame according to the orientation of the camera (horizontal/vertical).

#### AF Point Only:

Switches the position of the focusing frame according to the orientation of the camera (horizontal/vertical). The [Focus Area] is fixed.

#### AF Point + AF Area:

Switches both the [Focus Area] and the position of the focusing frame according to the orientation of the camera (horizontal/vertical).



### An example when [AF Point + AF Area] is selected



- (A) Vertical: [Flexible Spot] (Upper left corner)  
 (B) Horizontal: [Flexible Spot] (Upper right corner)  
 (C) Vertical: [Center]

- Three camera orientations are detected: horizontal, vertical with the side of the shutter button facing up, and vertical with the side of the shutter button facing down.

### Note

- If the setting for [ Swt. V/H AF Area] is changed, the focus settings for each camera orientation will not be retained.
- The [Focus Area] and the position of the focusing frame will not change even when [ Swt. V/H AF Area] is set to [AF Point + AF Area] or [AF Point Only] in the following situations:
  - When the shooting mode is set to [Intelligent Auto], [Superior Auto], [Movie], or [High Frame Rate]
  - While the shutter button is pressed halfway down
  - During movie shooting
  - While using the digital zoom function
  - While the auto-focusing is activated
  - During continuous shooting
  - During the countdown for the self-timer
  - When [Focus Magnifier] is activated

- When you shoot images right after the power is turned on and the camera is vertical, the first shot is taken with the horizontal focus setting or with the last focus setting.
- The orientation of the camera cannot be detected when the lens is facing up or down.

---

---

### Related Topic

- [Focus Area](#)



4-725-901-11(2) Copyright 2017 Sony Corporation



Digital Still Camera  
DSC-RX10M4

## AF Illuminator (still image)

The AF illuminator supplies fill light to focus more easily on a subject in dark surroundings. In the time between pressing the shutter button halfway down and locking the focus, the red AF illuminator lights up to allow the camera to focus easily.

1 MENU →  1 (Camera Settings1) → [ AF Illuminator] → desired setting.

### Menu item details



#### Auto:

The AF illuminator lights up automatically in dark surroundings.

#### Off:

Does not use the AF illuminator.

#### Note

- You cannot use [ AF Illuminator] in the following situations:
  - In movie mode
  - Sweep Panorama
  - When [Focus Mode] is set to [Continuous AF] or [Automatic AF] and the subject is moving (when the focus indicator  or  lights up).
  - When [Focus Magnifier] is activated.
  - When [Scene Selection] is set to the following modes:
    - [Landscape]
    - [Sports Action]
    - [Night Scene]
- If the Multi Interface Shoe is equipped with a flash with an AF illuminator function, when the flash is turned on, the AF illuminator will turn on as well.
- The AF illuminator emits a very bright light. Although there is no health hazard, do not look directly into the AF illuminator at close range.

## Center Lock-on AF

When you press the center of the control wheel, the camera detects the subject positioned in the center of the screen and continues to track the subject.

**1** MENU →  (Camera Settings1) → [Center Lock-on AF] → [On].

**2** Align the target frame (A) over the subject and press the center of the control wheel.

- Press the center again to stop tracking.

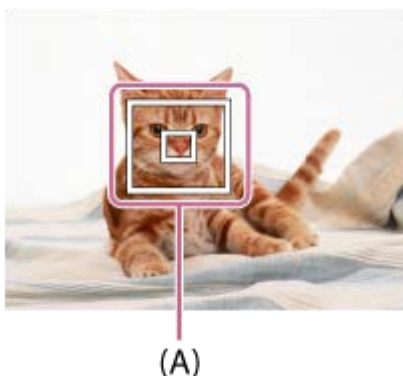



**3** Press the shutter button fully down to shoot the image.

### Hint

- If you assign the [Focus Standard] function to the key of your choice, you can activate [Center Lock-on AF] or detect a subject again by pressing the key when [Focus Area] is set to [Wide] or [Center].
- You can select the subject to be tracked by touch operation when shooting using the monitor. Set [Touch Operation] to other than [Off].

### Note

- The [Center Lock-on AF] function may not function very well in the following situations:
  - The subject is moving too quickly.
  - The subject is too small, or too large.
  - The contrast between the subject and the background is poor.
  - It is dark.
  - The ambient light changes.
- Lock-on AF does not work in the following situations:
  - [Sweep Panorama]
  - When [Scene Selection] is set to [Hand-held Twilight] or [Anti Motion Blur].
  - When [Smart Telecon.] is being used.
  - When shooting in Manual Focus mode.
  - When using the digital zoom
  - When the shooting mode is set to Movie, and [ SteadyShot] is set to [Intelligent Active].
  - When shooting movies with [ Record Setting] set to [120p]/[100p]
  - During High Frame Rate shooting

---

---

## Related Topic

- [Focus Standard](#)



4-725-901-11(2) Copyright 2017 Sony Corporation

Digital Still Camera  
DSC-RX10M4

## AF w/ shutter (still image)

---

Selects whether to focus automatically when you press the shutter button halfway down. Select [Off] to adjust the focus and the exposure separately.

1 MENU →  (Camera Settings1) → [ AF w/ shutter] → desired setting.

### Menu item details

**On:**

The auto focus operates when you press the shutter button halfway down.

**Off:**

The auto focus does not operate even if you press the shutter button halfway down.

---

### Related Topic

- [AF On](#)
- [Pre-AF \(still image\)](#)
- [Focus Magnifier](#)

Digital Still Camera  
DSC-RX10M4

## Pre-AF (still image)

---

The product automatically adjusts focus before you press the shutter button halfway down.

**1** MENU →  (Camera Settings1) → [ Pre-AF] → **desired setting.**

### Menu item details

**On:**

Adjusts focus before you press the shutter button halfway down.

**Off:**

Does not adjust focus before you press the shutter button halfway down.

## Registering the current focus area (AF Area Regist.)

You can move the focusing frame to a preassigned position temporarily using a custom key. This function is useful when shooting scenes in which the subject's movements are predictable; for example, sports scenes. With this function, you can switch the focus area quickly according to the situation.

### How to register focus area

1. MENU → 1 (Camera Settings1) → [ AF Area Regist.] → [On].
2. Set the focus area to the desired position and then hold down the Fn (Function) button.

### How to call up the registered focus area

1. MENU → 2 (Camera Settings2) → [Custom Key(Shoot.)] → desired key, then select [Regist. AF Area hold].
2. Set the camera to the shooting mode, hold down the key to which [Regist. AF Area hold] has been assigned and then press the shutter button to shoot images.

#### Hint

- When a focusing frame is registered using [ AF Area Regist.], the registered focusing frame flashes on the monitor.
- If you assign [Regist AF Area toggle] to a custom key, you can use the registered focusing frame without holding down the key.
- If [Reg. AF Area+AF On] is assigned to a custom key, auto focusing using the registered focusing frame is performed when the key is pressed.

#### Note

- A focus area cannot be registered in the following situations:
  - The mode dial is set to either (Movie) or **HFR**
  - While [Touch Focus] is being performed
  - While using the digital zoom function
  - While [Lock-on AF] is being performed
  - While focusing
  - While performing focus lock
- You cannot assign [Regist. AF Area hold] to [Left Button], [Right Button], or [Down Button].
- You cannot call up the registered focus area in the following situations:
  - The mode dial is set to either **AUTO** (Auto Mode), (Movie) or **HFR**
- When [ AF Area Regist.] is set to [On], the [Dial / Wheel Lock] setting is locked to [Unlock].

### Related Topic

- [Focus Area](#)
- [Custom Key\(Shoot.\)/Custom Key\(PB\)](#)

Digital Still Camera  
DSC-RX10M4

## Deleting a registered AF Area (Del. Reg. AF Area)

---

Deletes the focusing frame position that was registered using [ AF Area Regist.].

1 MENU →  (Camera Settings1) → [ Del. Reg. AF Area].

---

### Related Topic

- [Registering the current focus area \(AF Area Regist.\)](#)

Digital Still Camera  
DSC-RX10M4

## AF Area Auto Clear

---

Sets whether the focus area should be displayed all the time or should disappear automatically shortly after focus is achieved.

**1** MENU →  1 (Camera Settings1) → [AF Area Auto Clear] → desired setting.

### Menu item details

**On:**

The focus area disappears automatically shortly after focus is achieved.

**Off:**

The focus area is displayed all the time.



Digital Still Camera  
DSC-RX10M4

## Disp. cont. AF area

---

You can set whether or not to display the area that is in focus when [Focus Area] is set to [Wide], in [Continuous AF] mode.

1 MENU →  (Camera Settings1) → [Disp. cont. AF area] → desired setting.

### Menu item details

**On:**

Displays the focus area that is in focus.

**Off:**

Does not display the focus area that is in focus.

**Note**

- When [Focus Area] is set to one of the following, the focusing frames in the area that is in focus turn green:
  - [Center]
  - [Flexible Spot]
  - [Expand Flexible Spot]

Digital Still Camera  
DSC-RX10M4

## Phase Detect. Area

---

Sets whether or not to display the Phase Detection AF area.

1 MENU →  1 (Camera Settings1) → [Phase Detect. Area] → desired setting.

### Menu item details



#### On:

Displays the Phase Detection AF area.

#### Off:

Does not display the Phase Detection AF area.

#### Note

- When the F-value is larger than F8, Phase Detection AF cannot be used. Only Contrast AF is available.
- When [ File Format] is set to [XAVC S HD] and [ Record Setting] is set to [120p]/[100p], Phase Detection AF cannot be used. Only Contrast AF is available.
- When recording movies, the Phase Detection AF area will not be displayed.

## Exposure Comp.

Normally, exposure is set automatically (auto exposure). Based on the exposure value set by auto exposure, you can make the entire image brighter or darker if you adjust [Exposure Comp.] to the plus side or minus side, respectively (exposure compensation).

### 1 Turn the exposure compensation dial (A).

**+ (over) side:**

Images become brighter.

**- (under) side:**

Images become darker.

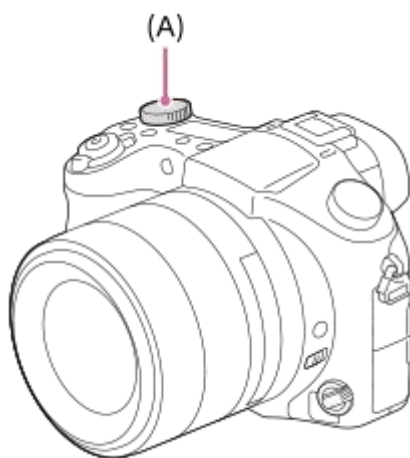

- You can adjust the exposure compensation value within the range of -3.0 EV to +3.0 EV.
- You can confirm the exposure compensation value that you set on the shooting screen.

**Monitor**

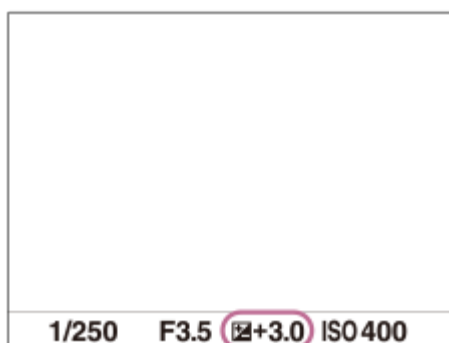

**Viewfinder**

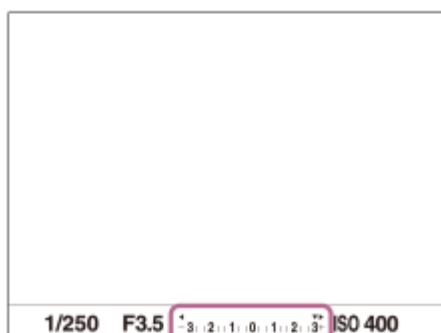

## To set the exposure compensation value using the MENU

You can adjust the exposure compensation value within a range of -3.0 EV to +3.0 EV when the exposure compensation dial is set to "0."

MENU →  1 (Camera Settings1) → [Exposure Comp.] → desired setting.

### Note

- You cannot perform the exposure compensation in the following shooting modes:
  - [Intelligent Auto]
  - [Superior Auto]
  - [Scene Selection]
- When using [Manual Exposure], you can perform the exposure compensation only when [ISO] is set to [ISO AUTO].
- The settings of the exposure compensation dial will be prioritized over [Exposure Comp.] in MENU.
- You can adjust the exposure compensation value within the range of -2.0 EV to +2.0 EV for movies.
- If you shoot a subject in extremely bright or dark conditions, or when you use the flash, you may not be able to get a satisfactory effect.
- When you set the exposure compensation dial to "0" from a setting other than "0," the exposure value switches to "0" regardless of the [Exposure Comp.] setting.

---

### Related Topic

- [Exp.comp.set](#)
- [Cont. Bracket](#)
- [Single Bracket](#)
- [Zebra](#)

Digital Still Camera  
DSC-RX10M4

## Reset EV Comp.

---

Sets whether to maintain the exposure value set using [Exposure Comp.] when you turn off the power when the exposure compensation dial position is set to "0."

**1** MENU →  1 (Camera Settings1) → [Reset EV Comp.] → desired setting.

### Menu item details

**Maintain:**

Maintains the settings.

**Reset:**

Resets the settings.

Digital Still Camera  
DSC-RX10M4

## ISO

Sensitivity to light is expressed by the ISO number (recommended exposure index). The larger the number, the higher the sensitivity.

1 MENU →  (Camera Settings1) → [ISO] → desired setting.

### Menu item details

#### Multi Frame NR:

Combines continuous shots to create an image with less noise. Press the right side to display the setting screen, then select a desired value using the top/bottom sides of the control wheel.

Select the desired ISO number from ISO AUTO or ISO 100 – ISO 25600.

#### ISO AUTO:

Sets the ISO sensitivity automatically.

#### ISO 64 – ISO 12800:

Sets the ISO sensitivity manually. Selecting a larger number increases the ISO sensitivity.

#### Hint

- You can change the range of ISO sensitivity that is set automatically in [ISO AUTO] mode. Select [ISO AUTO] and press the right side of the control wheel, and set the desired values for [ISO AUTO Maximum] and [ISO AUTO Minimum].
- The values are also applied when shooting in [ISO AUTO] mode under [Multi Frame NR].
- You can set the effect level for noise reduction by selecting [NR Effect] under [Multi Frame NR].

#### Note

- When [Quality] is set to [RAW] or [RAW & JPEG], [Multi Frame NR] cannot be selected.
- When [Multi Frame NR] is selected, the flash, [D-Range Opt.], or [Auto HDR] cannot be used.
- When [Picture Profile] is set to other than [Off], [Multi Frame NR] cannot be selected.
- When [Picture Effect] is set to other than [Off], [Multi Frame NR] cannot be selected.
- [ISO AUTO] is selected when using the following functions:
  - [Intelligent Auto]
  - [Superior Auto]
  - [Scene Selection]
  - [Sweep Panorama]
- When the ISO sensitivity is set to a value lower than ISO 100, the range for recordable subject brightness (dynamic range) may decrease.
- The higher the ISO value, the more noise will appear on the images.
- The available ISO settings will differ depending on whether you are shooting still images, shooting movies, or using HFR.
- When shooting movies, ISO values between 100 and 12800 are available. If the ISO value is set to a value smaller than 100, the setting is automatically switched to 100. When you finish recording the movie, the ISO value returns to the original setting.
- When you use [Multi Frame NR], it takes some time for the product to perform the overlay processing of images.
- When you select [ISO AUTO] with the shooting mode set to [P], [A], [S] or [M], the ISO sensitivity will be automatically adjusted within the set range.



Digital Still Camera  
DSC-RX10M4

## ISO AUTO Min. SS

If you select [ISO AUTO] or [ISO AUTO] under [Multi Frame NR] when the shooting mode is P (Program Auto) or A (Aperture Priority), you can set the shutter speed at which the ISO sensitivity starts changing.

This function is effective for shooting moving subjects. You can minimize subject blurring while also preventing camera shake.

1 MENU →  1 (Camera Settings1) → [ISO AUTO Min. SS] → desired setting.

### Menu item details

#### FASTER (Faster)/FAST (Fast):

The ISO sensitivity will start to change at shutter speeds faster than [Standard], so you can prevent camera shake and subject blurring.

#### STD (Standard):

The camera automatically sets the shutter speed based on the focal length of the lens.

#### SLOW (Slow)/SLOWER (Slower):

The ISO sensitivity will start to change at shutter speeds slower than [Standard], so you can shoot images with less noise.



#### 1/32000 — 30":

The ISO sensitivity starts to change at the shutter speed you have set.

#### Hint

- The difference in shutter speed at which ISO sensitivity starts to change between [Faster], [Fast], [Standard], [Slow], and [Slower] is 1 EV.

#### Note

- If the exposure is insufficient even when the ISO sensitivity is set to [ISO AUTO Maximum] in [ISO AUTO], in order to shoot with an appropriate exposure, the shutter speed will be slower than the speed set in [ISO AUTO Min. SS].
- In the following situations, the shutter speed may not function as set:
  - When the maximum shutter speed has changed based on the aperture or the [ Shutter Type] setting.
  - When using the flash to shoot bright scenes with the [ Shutter Type] set to [Electronic Shut.]. (The maximum shutter speed is limited to the flash-syncing speed of 1/100 second.)
  - When using the flash to shoot dark scenes with the [Flash Mode] set to [Fill-flash] or [Wireless]. (The minimum shutter speed is limited to the speed automatically determined by the camera.)

### Related Topic

- [Program Auto](#)
- [Aperture Priority](#)
- [ISO](#)



Digital Still Camera  
DSC-RX10M4

## Metering Mode

Selects the metering mode that sets which part of the screen to measure for determining the exposure.

1 MENU →  (Camera Settings1) → [Metering Mode] → desired setting.

### Menu item details

#### Multi:

Measures light on each area after dividing the total area into multiple areas and determines the proper exposure of the entire screen (Multi-pattern metering).

#### Center:

Measures the average brightness of the entire screen, while emphasizing the central area of the screen (Center-weighted metering).

#### Spot:

Measures only the central area (Spot metering). This mode is suitable for measuring light on a specified part of the entire screen. The size of the metering circle can be selected from [Spot: Standard] and [Spot: Large]. The position of the metering circle depends the setting for [Spot Metering Point].

#### Entire Screen Avg.:

Measures the average brightness of the entire screen. The exposure will be stable even if the composition or the position of the subject changes.

#### Highlight:

Measures the brightness while emphasizing the highlighted area on the screen. This mode is suitable for shooting the subject while avoiding overexposure.

### Hint

- When [Spot] is selected and [Focus Area] is set to either [Flexible Spot] or [Expand Flexible Spot] while [Spot Metering Point] is set to [Focus Point Link], the spot metering point can be coordinated with the focus area.
- When [Metering Mode] is set to [Highlight] and the [D-Range Opt.] or [Auto HDR] function is activated, the brightness and the contrast will be corrected automatically by dividing the image into small areas and analyzing the contrast of light and shadow. Make settings based on the shooting circumstances.

### Note

- [Metering Mode] is locked to [Multi] in the following shooting modes:
  - [Intelligent Auto]
  - [Superior Auto]
  - [Scene Selection]
  - Other zoom functions than the optical zoom
- In [Highlight] mode, the subject may be dark if a brighter part exists on the screen.

### Related Topic

- [AE lock](#)
- [Spot Metering Point](#)
- [D-Range Opt. \(DRO\)](#)
- [Auto HDR](#)



Digital Still Camera  
DSC-RX10M4

## Spot Metering Point

---

Sets whether to coordinate the spot metering position with the focus area when [Focus Area] is set to [Flexible Spot] or [Expand Flexible Spot].

1 MENU →  (Camera Settings1) → [Spot Metering Point] → desired setting.

### Menu item details

#### Center:

The spot metering position does not coordinate with the focus area, but always meters brightness at the center.

#### Focus Point Link:

The spot metering position coordinates with the focus area.

#### Note

- When [Focus Area] is set to other than [Flexible Spot] or [Expand Flexible Spot], the spot metering position is locked to the center.
- When [Focus Area] is set to [Lock-on AF: Flexible Spot] or [Lock-on AF:Expand Flexible Spot], the spot metering position coordinates to the Lock-on AF start position, but does not coordinate with the tracking of the subject.

---

### Related Topic



- [Focus Area](#)
- [Metering Mode](#)

Digital Still Camera  
DSC-RX10M4

## AEL w/ shutter (still image)

---

Sets whether to fix the exposure when you press the shutter button halfway down.  
Select [Off] to adjust the focus and the exposure separately.

1 MENU →  (Camera Settings1) → [ AEL w/ shutter] → desired setting.

### Menu item details

**Auto:**

Fixes the exposure after adjusting the focus automatically when you press the shutter button halfway down with the focus mode dial turned to "S (Single-shot AF)." When focus mode is set to "A (Automatic AF)" and the product determines that the subject is moving, or you shoot burst images, the fixed exposure is cancelled.

**On:**

Fixes the exposure when you press the shutter button halfway down.

**Off:**

Does not fix the exposure when you press the shutter button halfway down. Use this mode when you want to adjust focus and exposure separately.

The product keeps adjusting the exposure while shooting in [Cont. Shooting] mode.

**Note**

- Operation using the AEL button is prioritized over the [ AEL w/ shutter] settings.

Digital Still Camera  
DSC-RX10M4

## Exposure Std. Adjust

Adjusts this camera's standard for the correct exposure value for each metering mode.

- 1 MENU →  1 (Camera Settings1) → [Exposure Std. Adjust] → desired metering mode.
- 2 Select the desired value as the metering standard.
  - You can set a value from -1 EV to +1 EV in 1/6 EV increments.

## Metering Mode

The set standard value will be applied when you select the corresponding metering mode in MENU →  1 (Camera Settings1) → [Metering Mode].

 Multi/  Center/  Spot/  Entire Screen Avg./  Highlight

### Note

- The exposure compensation will not be affected when [Exposure Std. Adjust] is changed.
- The exposure value will be locked according to the value set for [  Spot] during using spot AEL.
- The standard value for M.M (Metered Manual) will be changed according to the value set in [Exposure Std. Adjust].
- The value set in [Exposure Std. Adjust] is recorded in Exif data separately from the exposure compensation value. The amount of exposure standard value will not be added to the exposure compensation value.
- If you set [Exposure Std. Adjust] during bracketing shooting, the number of shots for the bracketing will be reset.

## Related Topic

- [Metering Mode](#)

Digital Still Camera  
DSC-RX10M4

## Flash Mode

---

You can set the flash mode.

1 MENU →  1 (Camera Settings1) → [Flash Mode] → desired setting.

### Menu item details

#### Flash Off:

The flash does not operate.

#### Autoflash:

The flash works in dark environments or when shooting towards bright light.

#### Fill-flash:

The flash works every time you trigger the shutter.

#### Slow Sync.:

The flash works every time you trigger the shutter. Slow sync shooting allows you to shoot a clear image of both the subject and the background by slowing the shutter speed.

#### Rear Sync.:

The flash works right before the exposure is completed every time you trigger the shutter. Rear sync shooting allows you to shoot a natural image of the trail of a moving subject such as a moving car or a walking person.

#### Wireless:

Using a wireless flash creates a shading effect that gives the subject a more 3D appearance than when using the camera's flash.

This mode is effective when you attach a remote control-compatible external flash (sold separately) to the product, and shoot with a wireless flash (sold separately), placed away from the product.

#### Note

- The default setting depends on the shooting mode.
- Some [Flash Mode] settings are not available, depending on the shooting mode.
- The [Wireless] setting cannot be used with the camera's built-in flash.

---

### Related Topic

- [Using flash](#)
- [Wireless flash shooting](#)

Digital Still Camera  
DSC-RX10M4

## Flash Comp.

Adjusts the amount of flash light in a range of  $-3.0$  EV to  $+3.0$  EV. Flash compensation changes the amount of flash light only. Exposure compensation changes the amount of flash light along with the change of the shutter speed and aperture.

1 MENU →  1 (Camera Settings1) → [Flash Comp.] → desired setting.

- Selecting higher values (+ side) makes the flash level higher, and lower values (- side) makes the flash level lower.

### Note

- [Flash Comp.] does not work when the shooting mode is set to the following modes:
  - [Intelligent Auto]
  - [Superior Auto]
  - [Sweep Panorama]
  - [Scene Selection]
- The higher flash effect (+ side) may not be visible due to the limited amount of flash light available, if the subject is outside the maximum range of the flash. If the subject is very close, the lower flash effect (- side) may not be visible.

### Related Topic

- [Using flash](#)

Digital Still Camera  
DSC-RX10M4

## Exp.comp.set

---

Sets whether to apply the exposure compensation value to control both flash light and ambient light, or just ambient light.

**1** MENU →  (Camera Settings1) → [Exp.comp.set] → **desired setting.**

### Menu item details

**Ambient&flash:**

Applies the exposure compensation value to control both flash light and ambient light.

**Ambient only:**

Applies the exposure compensation value to control ambient light only.

---

### Related Topic

- [Flash Comp.](#)



Digital Still Camera  
DSC-RX10M4

## Red Eye Reduction

---

When using the flash, it is fired two or more times before shooting to reduce the red-eye phenomenon.

**1** MENU →  (Camera Settings1) → [Red Eye Reduction] → desired setting.

### Menu item details

**On:**

The flash is always fired to reduce the red-eye phenomenon.

**Off:**

Does not use Red Eye Reduction.

**Note**

- Red Eye Reduction may not produce the desired effects. It depends on individual differences and conditions, such as distance to the subject, or whether the subject looks at the pre-strobe or not.









Digital Still Camera  
DSC-RX10M4

## White Balance

Corrects the tone effect of the ambient light condition to record a neutral white subject in white. Use this function when the color tones of the image did not come out as you expected, or when you want to change the color tones on purpose for photographic expression.

1 MENU →  1 (Camera Settings1) → [White Balance] → desired setting.

### Menu item details

**AWB**  **AWB**  **Auto** /  **Daylight** /  **Shade** /  **Cloudy** /  **Incandescent** /  **-1 Fluor.: Warm White** /  **0 Fluor.: Cool White** /  **+1 Fluor.: Day White** /  **+2 Fluor.: Daylight** /  **Flash**: When you select a light source that illuminates the subject, the product adjusts the color tones to suit to the selected light source (preset white balance). When you select [Auto], the product automatically detects the light source and adjusts the color tones.

 **C.Temp./Filter**:

Adjusts the color tones depending on the light source. Achieves the effect of CC (Color Compensation) filters for photography.

 **Custom 1/Custom 2/Custom 3**:



Uses the white balance setting saved in [Custom Setup].

 **SET Custom Setup**:

Memorizes the basic white color under the light conditions for the shooting environment.

Select a memorized custom white balance number.

### Hint

- You can display the fine adjustment screen and perform fine adjustments of the color tones as required by pressing the right side of the control wheel.
- If the color tones do not come out as you expected in the selected settings, perform [WB bracket] shooting.
- **AWB**  or **AWB**  is displayed only when [Priority Set in AWB] is set to [Ambience] or [White].

### Note

- [White Balance] is fixed to [Auto] in the following shooting modes:
  - [Intelligent Auto]
  - [Superior Auto]
  - [Scene Selection]
- If you use a mercury lamp or a sodium lamp as a light source, the accurate white balance will not be obtained because of the characteristics of the light. It is recommended to shoot images using a flash or select [Custom Setup].

### Related Topic

- [Capturing a basic white color in \[Custom Setup\] mode](#)
- [Priority Set in AWB](#)
- [WB bracket](#)

Digital Still Camera  
DSC-RX10M4

## Priority Set in AWB

---

Selects which tone to prioritize when shooting under lighting conditions such as incandescent light when [White Balance] is set to [Auto].

1 MENU →  1 (Camera Settings1) → [Priority Set in AWB] → desired setting.

### Menu item details

AWB  
STD **Standard:**

Shoots with standard auto white balance. The camera automatically adjusts the color tones.

AWB  
Ambi **Ambience:**

Prioritizes the color tone of the light source. This is suitable when you want to produce a warm atmosphere.

AWB  
White **White:**

Prioritizes a reproduction of white color when the color temperature of the light source is low.

---

### Related Topic

- [White Balance](#)

Digital Still Camera  
DSC-RX10M4

## D-Range Opt. (DRO)

By dividing the image into small areas, the product analyzes the contrast of light and shadow between the subject and the background, and creates an image with the optimal brightness and gradation.

- 1 MENU →  (Camera Settings1) → [DRO/Auto HDR] → [D-Range Opt.].
- 2 Select the desired setting using the left/right sides of the control wheel.

### Menu item details

#### D-Range Optimizer: Auto:

Corrects the brightness automatically.

#### D-Range Optimizer: Lv1 — D-Range Optimizer: Lv5:

Optimizes the gradation of a recorded image for each divided area. Select the optimization level from Lv1 (weak) to Lv5 (strong).

#### Note

- In the following situations, [D-Range Opt.] is fixed to [Off]:
  - The shooting mode is set to [Sweep Panorama].
  - Multi Frame NR
  - When [Picture Effect] is set to other than [Off]
  - When [Picture Profile] is set to other than [Off]
- [DRO/Auto HDR] is fixed to [Off] when the following modes are selected in [Scene Selection].
  - [Sunset]
  - [Night Scene]
  - [Night Portrait]
  - [Hand-held Twilight]
  - [Anti Motion Blur]

The setting is fixed to [D-Range Optimizer: Auto] when [Scene Selection] modes other than the above modes are selected.
- When [ Record Setting] is set to [120p 100M], [100p 100M], [120p 60M], or [100p 60M], [DRO/Auto HDR] switches to [Off].
- When shooting with [D-Range Opt.], the image may be noisy. Select the proper level by checking the recorded image, especially when you enhance the effect.

Digital Still Camera  
DSC-RX10M4

## Auto HDR

Shoots three images using different exposures and combines the images with correct exposure, the bright parts of an underexposed image, and the dark parts of an overexposed image to create images with a greater range of gradation (High Dynamic Range). One image with proper exposure and one overlaid image are recorded.

1 MENU →  1 (Camera Settings1) → [DRO/Auto HDR] → [Auto HDR].

2 Select the desired setting using the left/right sides of the control wheel.

### Menu item details

 **Auto HDR: Exposure Diff. Auto:**

Corrects the brightness automatically.

 **Auto HDR: Exposure Diff. 1.0EV — Auto HDR: Exposure Diff. 6.0EV:**



Sets the exposure difference, based on the contrast of the subject. Select the optimization level from 1.0EV (weak) to 6.0EV (strong).

For example, if you set the exposure value to 2.0 EV, three images will be composed with the following exposure levels: -1.0 EV, correct exposure and +1.0 EV.

#### Hint

- The shutter is released three times for one shot. Be careful about the following:
  - Use this function when the subject is motionless or does not flash light.
  - Do not change the composition before shooting.

#### Note

- This function is not available when the [ Quality] is [RAW] or [RAW & JPEG].
- [Auto HDR] is not available in the following shooting modes:
  - [Intelligent Auto]
  - [Superior Auto]
  - [Sweep Panorama]
  - [Scene Selection]
- [Auto HDR] is not available in the following situations:
  - When [Multi Frame NR] is selected.
  - When [Picture Effect] is set to other than [Off].
  - When [Picture Profile] is set to other than [Off].
- You cannot start the next shot until the capture process is completed after you shoot.
- You may not obtain the desired effect depending on the luminance difference of a subject and the shooting conditions.
- When the flash is used, this function has little effect.
- When the contrast of the scene is low or when product shake or subject blur occurs, you may not obtain good HDR images.   will be displayed over the recorded image to inform you when the camera detects image blurring. Change the composition or re-shoot the image carefully to avoid image blur, as needed.

## Creative Style

Allows you to set the desired image processing and finely adjust contrast, saturation and sharpness for each image style. You can adjust exposure (shutter speed and aperture) as you like with this function, unlike with [Scene Selection], where the product adjusts the exposure.

- 1 MENU → 1 (Camera Settings1) → [Creative Style].
- 2 Select the desired style or [Style Box] using the top/bottom sides of the control wheel.
- 3 To adjust (Contrast), (Saturation) and (Sharpness), select the desired item using the right/left sides, and then select the value using the top/bottom sides.

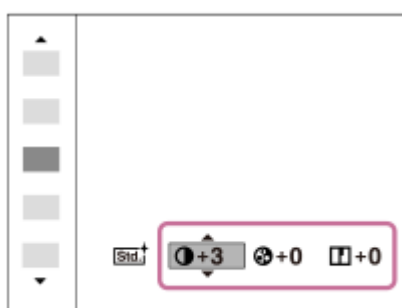

- 4 When selecting [Style Box], move to the right side using the right side of the control wheel, and then select the desired style.

- You can call up the same style with slightly different settings.

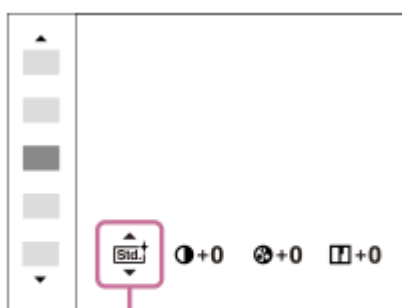

(A)

(A): Displayed only when Style Box is selected

### Menu item details

#### Standard:

For shooting various scenes with rich gradation and beautiful colors.

#### Vivid:

The saturation and contrast are heightened for shooting striking images of colorful scenes and subjects such as flowers, spring greenery, blue sky, or ocean views.

### **Neutral:**

The saturation and sharpness are lowered for shooting images in subdued tones. This is also suitable for capturing image material to be modified with a computer.

### **Clear:**

For shooting images in clear tones with limpid colors in highlight, suitable for capturing radiant light.

### **Deep:**

For shooting images with deep and dense colors, suitable for capturing the solid presence of the subject.

### **Light:**

For shooting images with bright and simple colors, suitable for capturing a refreshingly light ambience.

### **Portrait:**

For capturing skin in a soft tone, ideally suited for shooting portraits.

### **Landscape:**

The saturation, contrast, and sharpness are heightened for shooting vivid and crisp scenery. Distant landscapes also stand out more.

### **Sunset:**

For shooting the beautiful red of the setting sun.

### **Night Scene:**

The contrast is lowered for reproducing night scenes.

### **Autumn leaves:**

For shooting autumn scenes, vividly highlighting the reds and yellows of changing leaves.

### **Black & White:**

For shooting images in black and white monotone.

### **Sepia:**

For shooting images in sepia monotone.

### **Registering preferred settings (Style Box):**

Select the six style box (the boxes with numbers on the left side ()) to register preferred settings. Then select the desired settings using the right button.

You can call up the same style with slightly different settings.

## To set [Contrast], [Saturation] and [Sharpness]

[Contrast], [Saturation], and [Sharpness] can be adjusted for each image style preset such as [Standard] and [Landscape], and for each [Style Box] to which you can register preferred settings.

Select an item to be set by pressing the right/left sides of the control wheel, then set the value using the top/bottom sides of the control wheel.

### **Contrast:**

The higher the value selected, the more the difference of light and shadow is accentuated, and the bigger the effect on the image.

### **Saturation:**

The higher the value selected, the more vivid the color. When a lower value is selected, the color of the image is restrained and subdued.

### **Sharpness:**

Adjusts the sharpness. The higher the value selected, the more the contours are accentuated, and the lower the value selected, the more the contours are softened.

#### Note

- [Creative Style] is fixed to [Standard] in the following situations:
  - [Intelligent Auto]
  - [Superior Auto]
  - [Scene Selection]
  - [Picture Effect] is set to other than [Off].
  - [Picture Profile] is set to other than [Off].
- When this function is set to [Black & White] or [Sepia], [Saturation] cannot be adjusted.





Digital Still Camera  
DSC-RX10M4

## Picture Effect

Select the desired effect filter to achieve more impressive and artistic images.

1 MENU →  (Camera Settings1) → [Picture Effect] → desired setting.

### Menu item details

 **Off:**

Disables the [Picture Effect] function.

 **Toy Camera:**

Creates a soft image with shaded corners and reduced sharpness.

 **Pop Color:**

Creates a vivid look by emphasizing color tones.

 **Posterization:**

Creates a high contrast, abstract look by heavily emphasizing primary colors, or in black and white.

 **Retro Photo:**

Creates the look of an aged photo with sepia color tones and faded contrast.

 **Soft High-key:**

Creates an image with the indicated atmosphere: bright, transparent, ethereal, tender, soft.

 **Partial Color:**

Creates an image which retains a specific color, but converts others to black and white.

 **High Contrast Mono.:**

Creates a high-contrast image in black and white.

 **Soft Focus:**

Creates an image filled with a soft lighting effect.

 **HDR Painting:**

Creates the look of a painting, enhancing the colors and details.

 **Rich-tone Mono.:**

Creates an image in black and white with rich gradation and reproduction of details.

 **Miniature:**

Creates an image which enhances the subject vividly, with the background defocused considerably. This effect may often be found in pictures of miniature models.

 **Watercolor:**

Creates an image with ink bleed and blurring effects as if painted using watercolors.

 **Illustration:**

Creates an illustration-like image by emphasizing the outlines.

### Hint

- You can perform detailed settings for some items using the left/right sides of the control wheel.

### Note

- When you use a zoom function other than the optical zoom, setting the zoom scale larger makes [Toy Camera] less effective.
- When [Partial Color] is selected, images may not retain the selected color, depending on the subject or shooting conditions.
- You cannot check the following effects on the shooting screen, because the product processes the image after the shot. Also, you cannot shoot another image until image processing is finished. You cannot use these effects with movies.
  - [Soft Focus]

- [HDR Painting]
  - [Rich-tone Mono.]
  - [Miniature]
  - [Watercolor]
  - [Illustration]
- In the case of [HDR Painting] and [Rich-tone Mono.], the shutter is released three times for one shot. Be careful about the following:
    - Use this function when the subject is motionless or does not flash light.
    - Do not change the composition during shooting.

When the contrast of the scene is low or when significant camera-shake or subject blur has occurred, you may not be able to obtain good HDR images. If the product detects such a situation,  appear on the recorded image to inform you of this situation. Change the composition or re-shoot the image carefully to avoid image blur, as needed.

- This function is not available in the following shooting modes:
  - [Intelligent Auto]
  - [Superior Auto]
  - [Scene Selection]
  - [Sweep Panorama]
- When [ Quality] is set to [RAW] or [RAW & JPEG], this function is not available.

Digital Still Camera  
DSC-RX10M4

## Picture Profile

Allows you to change the settings for the color, gradation, etc. For details on "Picture Profile," refer to <http://helpguide.sony.net/di/pp/v1/en/index.html>.

### Customizing the picture profile

You can customize the picture quality by adjusting picture profile items such as [Gamma] and [Detail]. When setting these parameters, connect the camera to a TV or monitor, and adjust them while observing the picture on the screen.

- 1 MENU →  1 (Camera Settings1) → [Picture Profile] → the profile you want to change.
- 2 Move to the item index screen by pressing the right side of the control wheel.
- 3 Select the item to change using the top/bottom sides of the control wheel.
- 4 Select the desired value using the top/bottom sides of the control wheel and press in the center.

### Using the preset of the picture profile

The default settings [PP1] through [PP9] for movies have been set in advance in the camera based on various shooting conditions.

MENU →  1 (Camera Settings1) → [Picture Profile] → desired setting.

#### PP1:

Example setting using [Movie] gamma

#### PP2:

Example setting using [Still] gamma

#### PP3:

Example setting of natural color tone using the [ITU709] gamma

#### PP4:

Example setting of a color tone faithful to the ITU709 standard

#### PP5:

Example setting using [Cine1] gamma

#### PP6:

Example setting using [Cine2] gamma

#### PP7:

Example setting using [S-Log2] gamma

#### PP8:

Example setting using the [S-Log3] gamma and the [S-Gamut3.Cine] under [Color Mode].

#### PP9:

Example setting using the [S-Log3] gamma and the [S-Gamut3] under [Color Mode].

### Items of the picture profile

#### Black Level

Sets the black level. (-15 to +15)

#### Gamma

Selects a gamma curve.

Movie: Standard gamma curve for movies

Still: Standard gamma curve for still images

Cine1: Softens the contrast in dark parts and emphasizes gradation in bright parts to produce a relaxed color movie. (equivalent to HG4609G33)

Cine2: Similar to [Cine1] but optimized for editing with up to 100% video signal. (equivalent to HG4600G30)

ITU709: Gamma curve that corresponds to ITU709.

ITU709(800%): Gamma curve for confirming scenes on the assumption of shooting using [S-Log2] or [S-Log3].

S-Log2: Gamma curve for [S-Log2]. This setting is based on the assumption that the picture will be processed after shooting.

S-Log3: Gamma curve for [S-Log3] with more similar features to film. This setting is based on the assumption that the picture will be processed after shooting.

### Black Gamma

Corrects gamma in low intensity areas.

Range: Selects the correcting range. (Wide / Middle / Narrow)

Level: Sets the correcting level. (-7 (maximum black compression) to +7 (maximum black stretch))

### Knee

Sets knee point and slope for video signal compression to prevent over-exposure by limiting signals in high intensity areas of the subject to the dynamic range of your camera.

When [Still], [Cine1], [Cine2], [ITU709(800%)], [S-Log2], or [S-Log3] is selected in [Gamma], [Knee] becomes unavailable if [Mode] is set to [Auto]. To use the functions in [Knee], set [Mode] to [Manual].

Mode: Selects auto/manual settings.

- Auto: The knee point and slope are set automatically.
- Manual: The knee point and slope are set manually.

Auto Set: Settings when [Auto] is selected for [Mode].

- Max Point: Sets the maximum point of the knee point. (90% to 100%)
- Sensitivity: Sets the sensitivity. (High / Mid / Low)

Manual Set: Settings when [Manual] is selected for [Mode].

- Point: Sets the knee point. (75% to 105%)
- Slope: Sets the knee slope. (-5 (gentle) to +5 (steep))

### Color Mode

Sets type and level of colors.

Movie: Suitable colors when [Gamma] is set to [Movie].

Still: Suitable colors when [Gamma] is set to [Still].

Cinema: Suitable colors when [Gamma] is set to [Cine1].

Pro: Similar color tones to the standard image quality of Sony professional cameras (when combined with ITU709 gamma)

ITU709 Matrix: Colors corresponding to ITU709 standard (when combined with ITU709 gamma)

Black & White: Sets the saturation to zero for shooting in black and white.

S-Gamut: Setting based on the assumption that the pictures will be processed after shooting. Used when [Gamma] is set to [S-Log2].

S-Gamut3.Cine: Setting based on the assumption that the pictures will be processed after shooting. Used when [Gamma] is set to [S-Log3]. This setting allows you to shoot in a color space that can easily be converted for digital cinema.

S-Gamut3: Setting based on the assumption that the pictures will be processed after shooting. Used when [Gamma] is set to [S-Log3]. This setting allows you to shoot in a wide color space.

### Saturation

Sets the color saturation. (-32 to +32)

## Color Phase

Sets the color phase. (-7 to +7)

## Color Depth

Sets the color depth for each color phase. This function is more effective for chromatic colors and less effective for achromatic colors. The color looks deeper as you increase the setting value towards the positive side, and lighter as you decrease the value towards the negative side. This function is effective even if you set [Color Mode] to [Black & White].

[R] -7 (light red) to +7 (deep red)

[G] -7 (light green) to +7 (deep green)

[B] -7 (light blue) to +7 (deep blue)

[C] -7 (light cyan) to +7 (deep cyan)

[M] -7 (light magenta) to +7 (deep magenta)

[Y] -7 (light yellow) to +7 (deep yellow)

## Detail

Sets items for [Detail].

Level: Sets the [Detail] level. (-7 to +7)

Adjust: The following parameters can be selected manually.

- Mode: Selects auto/manual setting. (Auto (automatic optimization) / Manual (The details are set manually.))
- V/H Balance: Sets the vertical (V) and horizontal (H) balance of DETAIL. (-2 (off to the vertical (V) side) to +2 (off to the horizontal (H) side))
- B/W Balance: Selects the balance of the lower DETAIL (B) and the upper DETAIL (W). (Type1 (off to the lower DETAIL (B) side) to Type5 (off to the upper DETAIL (W) side))
- Limit: Sets the limit level of [Detail]. (0 (Low limit level: likely to be limited) to 7 (High limit level: unlikely to be limited))
- Crisping: Sets the crisping level. (0 (shallow crisping level) to 7 (deep crisping level))
- Hi-Light Detail: Sets the [Detail] level in the high intensity areas. (0 to 4)

## To copy the settings to another picture profile number

You can copy the settings of the picture profile to another picture profile number.

MENU →  1 (Camera Settings1) → [Picture Profile] → [Copy].

## To Reset the picture profile to the default setting

You can reset the picture profile to the default setting. You cannot reset all picture profile settings at once.

MENU →  1 (Camera Settings1) → [Picture Profile] → [Reset].

### Note

- Since the parameters are shared for movie and still images, adjust the value when you change the shooting mode.
- If you print RAW images with shooting settings, the following settings are not reflected:
  - Black Level
  - Black Gamma
  - Knee
  - Color Depth
- When the  [Record Setting] is [120p 100M]/[100p 100M] or [120p 60M]/[100p 60M], [Black Gamma] is fixed at “0” and cannot be adjusted.
- If you change [Gamma], the available ISO value range changes.
- When using S-Log2 or S-Log3 gamma, the noise becomes more noticeable compared to when using other gammas. If the noise still is significant even after processing pictures, it may be improved by shooting with a brighter setting. However, the dynamic range becomes narrower accordingly when you shoot with a brighter setting. We recommend checking the picture in advance by test shooting when using S-Log2 or S-Log3.
- Setting [ITU709(800%)], [S-Log2] or [S-Log3] may cause an error in the white balance custom setup. In this case, perform custom setup with a gamma other than [ITU709(800%)], [S-Log2], or [S-Log3] first, and then reselect [ITU709(800%)], [S-Log2], or [S-Log3] gamma.
- Setting [ITU709(800%)], [S-Log2] or [S-Log3] disables the [Black Level] setting.
- If you set [Slope] to +5 in [Manual Set], [Knee] is set to [Off].

- S-Gamut, S-Gamut3.Cine, and S-Gamut3 are color spaces exclusive to Sony. However, this camera's S-Gamut setting does not support the whole S-Gamut color space; it is a setting to achieve a color reproduction equivalent to S-Gamut.

---

---



### Related Topic

- [Gamma Disp. Assist](#)

4-725-901-11(2) Copyright 2017 Sony Corporation

## Soft Skin Effect (still image)

Sets the effect used for shooting the skin smoothly in the Face Detection function.

1 MENU →  1 (Camera Settings1) → [ Soft Skin Effect] → desired setting.

### Menu item details

 Off:

Does not use the [ Soft Skin Effect] function.





 On:

Uses the [ Soft Skin Effect].

### Hint

- When [ Soft Skin Effect] is set to [On], you can select the effect level. Select the effect level by pressing the right/left side of the control wheel.

### Note





- [ Soft Skin Effect] is not available when [ Quality] is [RAW].
- [ Soft Skin Effect] is not available for RAW images when the [ Quality] is [RAW & JPEG].

Digital Still Camera  
DSC-RX10M4

## Focus Magnifier

You can check the focus by enlarging the image before shooting.

Unlike with [ MF Assist], you can magnify the image without operating the lens ring.

- 1 MENU →  1 (Camera Settings1) → [Focus Magnifier].**
- 2 Press the center of the control wheel to enlarge the image and select the area you want to enlarge using top/bottom/left/right side of the control wheel.**
  - Each time you press the center, the magnification scale will change.
  - You can set the initial magnification by selecting MENU →  1 (Camera Settings1) → [ Initial Focus Mag.].
- 3 Confirm the focus.**
  - Press the  (Delete) button to bring the magnified position into the center of an image.
  - When the focus mode is [Manual Focus], you can adjust the focus while an image is magnified. The [Focus Magnifier] function will be canceled when the shutter button is pressed halfway.
  - You can set how long the image is to be shown magnified by selecting MENU →  1 (Camera Settings1) → [Focus Magnif. Time].
- 4 Press the shutter button fully down to shoot the image.**

### To use the focus magnifier function by touch operation

You can magnify the image and adjust the focus by touching the monitor. Set [Touch Operation] to other than [Off] beforehand. When the focus mode is [Manual Focus], you can perform [Focus Magnifier] by double-tapping the area to focus on while shooting with the monitor.

While shooting with the viewfinder, a frame is displayed in the center of the monitor by double-tapping and you can move the frame by dragging it. The image is magnified by pressing the center of the control wheel.

#### Hint

- While using the focus magnifier function, you can move the magnified area by dragging it on the touch panel.
- To exit the focus magnifier function, double-tap the monitor again. You can also exit the focus magnifier function by pressing the shutter button halfway down.

### Related Topic

- [MF Assist \(still image\)](#)
- [Focus Magnif. Time](#)
- [Initial Focus Mag. \(still image\)](#)
- [Custom Key\(Shoot.\)/Custom Key\(PB\)](#)
- [Touch Operation](#)







Digital Still Camera  
DSC-RX10M4

## Focus Magnif. Time

---

Set the duration for which an image is to be magnified using the [ MF Assist] or [Focus Magnifier] function.

**1** MENU →  1 (Camera Settings1) → [Focus Magnif. Time] → desired setting.

### Menu item details

**2 Sec:**

Magnifies the images for 2 seconds.

**5 Sec:**

Magnifies the images for 5 seconds.

**No Limit:**

Magnifies the images until you press the shutter button.

---

### Related Topic



- [Focus Magnifier](#)
- [MF Assist \(still image\)](#)

Digital Still Camera  
DSC-RX10M4

## Initial Focus Mag. (still image)

---

Sets the initial magnification scale when using [Focus Magnifier]. Select a setting that will help you frame your shot.

**1** MENU →  1 (Camera Settings1) → [ Initial Focus Mag.] → **desired setting.**

### Menu item details

**x1.0:**

Displays the image with the same magnification as the shooting screen.

**x5.3:**

Displays a 5.3-times enlarged image.

---

### Related Topic

- [Focus Magnifier](#)

Digital Still Camera  
DSC-RX10M4

## MF Assist (still image)

Enlarges the image on the screen automatically to make manual focusing easier. This works in Manual Focus or Direct Manual Focus shooting.

- 1 MENU →  (Camera Settings1) → [ MF Assist] → [On].
- 2 Turn the lens ring to which the focus function has been assigned to adjust the focus.
  - The image is enlarged. You can magnify images further by pressing the center of the control wheel.

### Hint

- You can set how long the image is to be shown magnified by selecting MENU →  (Camera Settings1) → [Focus Magnif. Time].

### Note

- You cannot use [ MF Assist] when shooting movies. Use the [Focus Magnifier] function instead.

### Related Topic

- [Manual Focus](#)
- [Direct manual focus \(DMF\)](#)
- [Focus Magnif. Time](#)

Digital Still Camera  
DSC-RX10M4

## Peaking Level

---

Enhances the outline of in-focus ranges using a specific color in Manual Focus or Direct Manual Focus shooting.

**1** MENU →  (Camera Settings1) → [Peaking Level] → desired setting.

### Menu item details

**High:**

Sets the peaking level to high.

**Mid:**

Sets the peaking level to middle.

**Low:**

Sets the peaking level to low.

**Off:**

Does not use the peaking function.

**Note**

- Since the product recognizes sharp areas as in focus, the effect of peaking differs, depending on the subject.
- The outline of in-focus ranges is not enhanced on devices connected via HDMI.

---

### Related Topic

- [Manual Focus](#)
- [Direct manual focus \(DMF\)](#)
- [Peaking Color](#)

Digital Still Camera  
DSC-RX10M4

## Peaking Color

---

Sets the color used for the peaking function in Manual Focus or Direct Manual Focus shooting.

**1** MENU →  (Camera Settings1) → [Peaking Color] → desired setting.

### Menu item details

**Red:**

Enhances outlines in red.

**Yellow:**

Enhances outlines in yellow.

**White:**

Enhances outlines in white.

---

### Related Topic

- [Manual Focus](#)
- [Direct manual focus \(DMF\)](#)
- [Peaking Level](#)

Digital Still Camera  
DSC-RX10M4

## Focus Ring Rotate

---

Assigns longer-distance and shorter-distance focus to the rotational directions of the lens ring to which the focus function has been assigned.

1 MENU →  1 (Camera Settings1) → [Focus Ring Rotate] → desired setting.

### Menu item details

Left  /Right  :

Assigns longer-distance focus to counterclockwise rotation and shorter-distance focus to clockwise rotation.

Right  /Left  :

Assigns longer-distance focus to clockwise rotation and shorter-distance focus to counterclockwise rotation.

---

### Related Topic

- [Lens Ring Setup](#)

Digital Still Camera  
DSC-RX10M4

## Smile/Face Detect.

Detects the faces of your subjects and adjusts the focus, exposure, flash settings and performs image processing automatically.

1 MENU →  (Camera Settings1) → [Smile/Face Detect.] → desired setting.

### Menu item details

#### Off:

Does not use the [Face Detection] function.

#### On (Regist. Faces):

Detects the registered face with higher priority using [Face Registration].

#### On:

Detects a face without giving higher priority to the registered face.

#### Smile Shutter:

Automatically detects and shoots a smile.

### Face Detection frame

- When the product detects a face, the gray face detection frame appears. When the product determines that autofocus is enabled, the face detection frame turns white. When a person's eyes are in focus and [Focus Mode] is set to [Single-shot AF], a green focus frame appears around the eyes for a certain period of time.
- In case you have registered the priority order for each face using [Face Registration], the product automatically selects the first prioritized face and the face detection frame over that face turns white. The face detection frames of other registered faces turn reddish-purple.

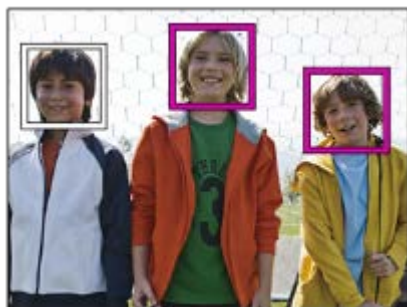

### Tips for capturing smiles more effectively

- Do not cover the eyes with front hair and keep the eyes narrowed.
- Do not obscure the face by a hat, masks, sunglasses, etc.
- Try to orient the face in front of the product and be as level as possible.
- Give a clear smile with an open mouth. The smile is easier to be detected when the teeth are shown.
- If you press the shutter button during Smile Shutter, the product shoots the image. After shooting, the product returns to Smile Shutter mode.

#### Hint

- When the [Smile/Face Detect.] is set to [Smile Shutter], you can select the Smile Detection Sensitivity from [On: Slight Smile], [On: Normal Smile] and [On: Big Smile].

#### Note

- You cannot use the Face Detection function with the following functions:



- Other zoom functions than the optical zoom
  - [Sweep Panorama]
  - [Picture Effect] is set to [Posterization].
  - When using the [Focus Magnifier] function.
  - [Scene Selection] is set to [Landscape], [Night Scene], [Sunset].
  - Movie shooting with [Record Setting] set to [120p]/[100p].
  - During High Frame Rate shooting
- 
- Up to 8 faces of your subjects can be detected.
  - The product may not detect faces at all or may accidentally detect other objects as faces in some conditions.
  - If the product cannot detect a smile, adjust the Smile Detection Sensitivity.
  - If you track a face using [Lock-on AF] while executing Smile Shutter function, Smile Detection is performed only for that face.

## Face Registration (New Registration)

---

If you register faces in advance, the product can detect the registered face as a priority when [Smile/Face Detect.] is set to [On (Regist. Faces)].

- 1 MENU →  (Camera Settings1) → [Face Registration] → [New Registration].
- 2 Align the guide frame with the face to be registered, and press the shutter button.
- 3 When a confirmation message appears, select [Enter].

### Note

- Up to eight faces can be registered.
- Shoot the face from the front in a brightly lit place. The face may not be registered correctly if it is obscured by a hat, a mask, sunglasses, etc.

---

### Related Topic

- [Smile/Face Detect.](#)

Digital Still Camera  
DSC-RX10M4

## Face Registration (Order Exchanging)

---

When multiple faces are registered to be given priority, the face registered first will be given priority. You can change the priority order.

- 1 MENU →  1 (Camera Settings1) → [Face Registration] → [Order Exchanging].
- 2 Select a face to change the order of priority.
- 3 Select the destination.

---

### Related Topic

- [Smile/Face Detect.](#)

Digital Still Camera  
DSC-RX10M4

## Face Registration (Delete)

---

Deletes a registered face.

**1** MENU →  (Camera Settings1) → [Face Registration] → [Delete].

If you select [Delete All], you can delete all registered faces.

### Note

- Even if you execute [Delete], the data for registered face will remain in the product. To delete the data for registered faces from the product, select [Delete All].

Digital Still Camera  
DSC-RX10M4

## Auto Obj. Framing (still image)

When this product detects and shoots faces, macro shooting subjects or subjects that are tracked by [Lock-on AF], the product automatically trims the image into an appropriate composition, and then saves it. Both the original and the trimmed images are saved. The trimmed image is recorded in the same size as the original image size.

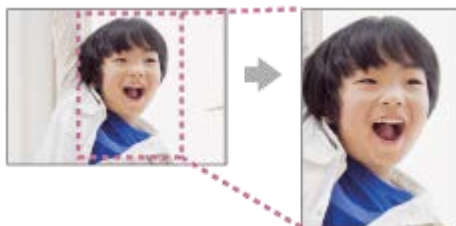

1 MENU → 1 (Camera Settings1) → [ Auto Obj. Framing] → desired setting.

### Menu item details

#### Off:

Does not trim images.

#### Auto:

Automatically trims images into an appropriate composition.



#### Note

- [ Auto Obj. Framing] is not available when the shooting mode is set to [Sweep Panorama], [Movie], or [High Frame Rate], or when [Scene Selection] is set to [Hand-held Twilight], [Sports Action], or [Anti Motion Blur].
- The trimmed image may not be the best possible composition, depending on the shooting conditions.
- [ Auto Obj. Framing] cannot be set when [ Quality] is set to [RAW] or [RAW & JPEG].
- [ Auto Obj. Framing] is not available in the following situations.
  - [Drive Mode] is set to [Cont. Shooting], [Self-timer(Cont)], [Cont. Bracket], [Single Bracket], [WB bracket], or [DRO Bracket].
  - The ISO sensitivity is set to [Multi Frame NR].
  - [DRO/Auto HDR] is set to [Auto HDR].
  - Other zoom functions than the optical zoom
  - When shooting in Manual Focus mode
  - [Picture Effect] is set to [Soft Focus], [HDR Painting], [Rich-tone Mono.], [Miniature], [Watercolor], or [Illustration].

Digital Still Camera  
DSC-RX10M4

## Movie: Exposure Mode

You can set the exposure mode for movie shooting.

- 1 Set the mode dial to  (Movie).
- 2 MENU →  (Camera Settings2) → [ Exposure Mode] → desired setting.
- 3 Press the MOVIE (movie) button to start recording.
  - Press the MOVIE button again to stop recording.

### Menu item details

#### Program Auto:

Allows you to shoot with the exposure adjusted automatically (both the shutter speed and the aperture value).

#### Aperture Priority:

Allows you to shoot after adjusting the aperture value manually.

#### Shutter Priority:

Allows you to shoot after adjusting the shutter speed manually.

#### Manual Exposure:

Allows you to shoot after adjusting the exposure (both the shutter speed and the aperture value) manually.

#### Note

- When you adjust the aperture using the aperture ring while recording a movie, set the Aperture Click Switch to “OFF.” If you change the aperture value while shooting a movie with the Aperture Click Switch set to “ON,” the sound of the aperture ring will be recorded.

Digital Still Camera  
DSC-RX10M4

## HFR (High Frame Rate): Exposure Mode

---

You can select the exposure mode for HFR shooting based on the subject and effect you want.

- 1 Set the mode dial to **HFR** (High Frame Rate).
- 2 MENU →  2 (Camera Settings2) → [**HFR** Exposure Mode] → desired setting.

### Menu item details

#### **HFR** Program Auto:

Allows you to shoot with the exposure adjusted automatically (both the shutter speed and the aperture value).

#### **HFR** Aperture Priority:

Allows you to shoot after adjusting the aperture value manually.

#### **HFR** Shutter Priority:

Allows you to shoot after adjusting the shutter speed manually.

#### **HFR** Manual Exposure:

Allows you to shoot after adjusting the exposure (both the shutter speed and the aperture value) manually.

---



### Related Topic

- [Shooting super-slow-motion movies \(HFR Settings\)](#)

Digital Still Camera  
DSC-RX10M4

## File Format (movie)



Selects the movie file format.

1 MENU →  2 (Camera Settings2) → [ File Format] → desired setting.

### Menu item details

 File Format	Characteristics	
XAVC S 4K	Records movies in 4K resolution (3840×2160).	You can save movies on a computer using the PlayMemories Home software.
XAVC S HD	Records movies in crisper quality than AVCHD with larger amounts of data.	You can save movies on a computer using the PlayMemories Home software.
AVCHD	The AVCHD format has a high degree of compatibility with storage devices other than computers.	You can save movies on a computer or create a disc that supports this format using the PlayMemories Home software.



#### Note

- When [ File Format] is set to [AVCHD], the file size of movies is limited to approx. 2 GB. If the movie file size reaches approx. 2 GB during recording, a new movie file will be created automatically.
- If you set [ File Format] to [XAVC S 4K] and shoot movies while the camera is connected to an HDMI device, images will not be displayed on the monitor.



## Record Setting (movie)

Selects the frame rate and bit-rate for movie recording.

1 MENU →  2 (Camera Settings2) → [ Record Setting] → desired setting.

- The higher the bit-rate, the higher the image quality.

### Menu item details

When [ File Format] is set to [XAVC S 4K]

 Record Setting	Bit-rate	Description
30p 100M/25p 100M	Approx. 100 Mbps	Records movies in 3840×2160 (30p/25p).
30p 60M/25p 60M	Approx. 60 Mbps	Records movies in 3840×2160 (30p/25p).
24p 100M*	Approx. 100 Mbps	Records movies in 3840×2160 (24p).
24p 60M*	Approx. 60 Mbps	Records movies in 3840×2160 (24p).

\* Only when [NTSC/PAL Selector] is set to NTSC

When [ File Format] is set to [XAVC S HD]

 Record Setting	Bit-rate	Description
60p 50M/50p 50M	Approx. 50 Mbps	Records movies in 1920×1080 (60p/50p).
60p 25M/50p 25M	Approx. 25 Mbps	Records movies in 1920×1080 (60p/50p).
30p 50M/25p 50M	Approx. 50 Mbps	Records movies in 1920×1080 (30p/25p).
30p 16M/25p 16M	Approx. 16 Mbps	Records movies in 1920×1080 (30p/25p).
24p 50M*	Approx. 50 Mbps	Records movies in 1920×1080 (24p).
120p 100M/100p 100M	Approx. 100 Mbps	Records high-speed movies in 1920×1080 (120p/100p). You can record movies in 120 fps or 100 fps. <ul style="list-style-type: none"> <li>• You can create smoother slow-motion movies by using compatible editing devices.</li> </ul>

 Record Setting	Bit-rate	Description
120p 60M/100p 60M	Approx. 60 Mbps	Records high-speed movies in 1920×1080 (120p/100p). You can record movies in 120 fps or 100 fps. <ul style="list-style-type: none"> <li>You can create smoother slow-motion movies by using compatible editing devices.</li> </ul>

\* Only when [NTSC/PAL Selector] is set to NTSC

### When [ File Format] is set to [AVCHD]

 Record Setting	Bit-rate	Description
60i 24M(FX)/50i 24M(FX)	24 Mbps at maximum	Records movies in 1920×1080 (60i/50i).
60i 17M(FH)/50i 17M(FH)	Approx. 17 Mbps on average	Records movies in 1920×1080 (60i/50i).

#### Note

- Movies recorded with the [60i 24M(FX)]/[50i 24M(FX)] as the [ Record Setting] are converted by PlayMemories Home in order to create an AVCHD recording disc. You cannot create a disc in the original image quality. This conversion can take a long time. If you want to keep the original image quality, store your movies on a Blu-ray Disc.
- [120p]/[100p] cannot be selected for the following settings.
  - [Intelligent Auto]
  - [Superior Auto]
  - [Scene Selection]

#### Related Topic

- [Shooting super-slow-motion movies \(HFR Settings\)](#)

## Shooting super-slow-motion movies (HFR Settings)

By shooting with a higher frame rate than the recording format, you can record a smooth super-slow-motion movie.

### 1 Set the mode dial to **HFR** (High Frame Rate).

The shooting setting screen will be displayed.

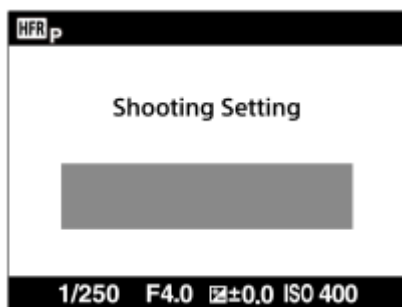

### 2 MENU → (Camera Settings2) → [**HFR** HFR Settings] and select the desired settings for [**HFR** Record Setting], [**HFR** Frame Rate], [**HFR** Priority Setting], and [**HFR** REC Timing].

- You can adjust the desired exposure mode by selecting MENU →  (Camera Settings2) → [**HFR** Exposure Mode].

### 3 Point the camera at the subject and adjust settings such as the focus.

- You can also change other settings, such as focus mode, ISO sensitivity, etc.

### 4 Press the center of the control wheel.

The shooting standby screen will be displayed.

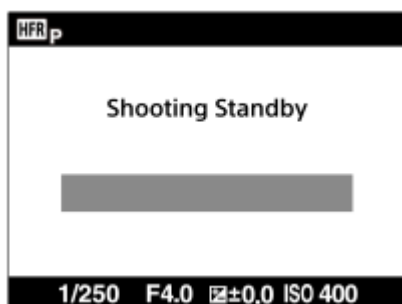

- During shooting standby, [Shooting Standby] is displayed in the center of the screen. You cannot adjust the exposure, adjust the focus, operate the zoom, etc. while [Shooting Standby] is displayed. If you want to change the shooting settings, press the center of the control wheel again to return to the shooting setting screen.

### 5 Press the **MOVIE** (Movie) button.

**When [**HFR** REC Timing] is set to [Start Trigger]:**

Movie capturing (shooting) starts. When the MOVIE button is pressed again, or when the recordable duration of time has elapsed, movie capturing ends and the camera starts to record the captured movie to the memory card.

**When [**HFR** REC Timing] is set to [End Trigger] or [End Trigger Half]:**

Movie capturing ends and the camera starts to record the captured movie to the memory card.

## Menu item details

### **HFR** Record Setting :

Selects the frame rate of the movie from [60p 50M]/[50p 50M], [30p 50M]/[25p 50M], and [24p 50M\*].

\* Only when [NTSC/PAL Selector] is set to NTSC.

### **HFR** Frame Rate :

Selects the shooting frame rate from [240fps]/[250fps], [480fps]/[500fps], and [960fps]/[1000fps].

### **HFR** Priority Setting :

Select from [Quality Priority] which prioritizes the image quality and [Shoot Time Priority] which prioritizes the duration of time of the movie.

### **HFR** REC Timing :

Selects whether to record for a set amount of time after you press the MOVIE button ([Start Trigger]), or for a set amount of time until you press the MOVIE button ([End Trigger]/[End Trigger Half]).

## Frame rate

In super-slow-motion movie shooting, the camera shoots at a faster shutter speed than the number of shooting frames per second. For example, when [**HFR** Frame Rate] is set to [960fps], the shutter speed per frame will be faster than approx. 1/1000 second in order to shoot 960 frames per second. To maintain this shutter speed, sufficient ambient light is necessary during shooting. If the ambient light is insufficient, the ISO sensitivity will become higher, resulting in more noise.

## Shortest shooting distance

- The image becomes out of focus when the subject is too close, such as during macro shooting. Shoot from the shortest shooting distance (from the front of the lens, approximately 3 cm (0.10 ft.) at the wide-angle end, approximately 72 cm (2.36 ft.) at the telephoto end, and approximately 140 cm (4.59 ft.) at a 35 mm-equivalent focal length of around 250 mm) or further.

## Timing of recording

Depending on the [**HFR** REC Timing] setting, the relationship between when you press the MOVIE button and the recorded section of the movie is as shown below.

### **[Start Trigger]**

Movie capturing (shooting) starts when the MOVIE button is pressed. When the MOVIE button is pressed again, or when the recordable duration of time has elapsed, movie capturing ends and the camera starts to record the captured movie to the memory card.

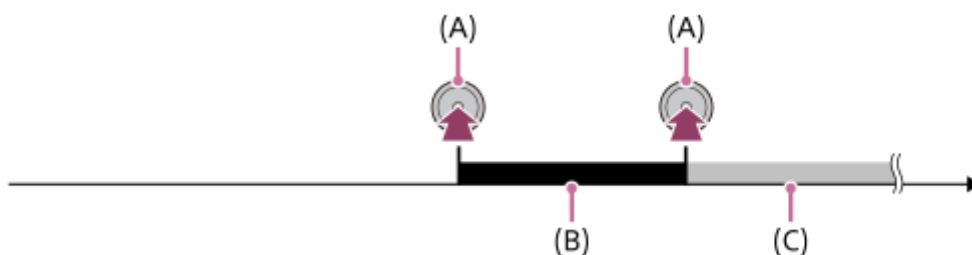

(A): The point when the MOVIE button is pressed

(B): Recorded section

(C): Recording to memory card in progress (You cannot start the next session of shooting.)

### **[End Trigger]/[End Trigger Half]**

Buffering (temporarily capturing a movie on the camera) starts once the shooting standby screen is displayed. When the captured data fills the buffering capacity, old data is overwritten sequentially. When you press the MOVIE button, the camera starts to record a movie of the set duration calculated retroactively from that point on the memory card.

- With [End Trigger], a movie of the maximum possible duration is recorded. With [End Trigger Half], a movie of half the maximum possible duration is recorded. With [End Trigger Half], the time it takes to record to the memory card is also shorter than with [End Trigger].

## End Trigger

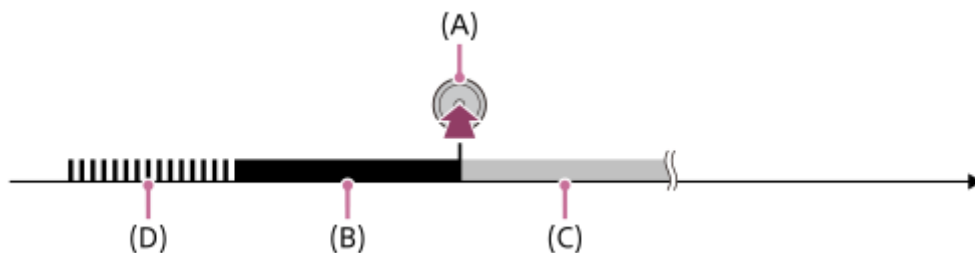

## End Trigger Half

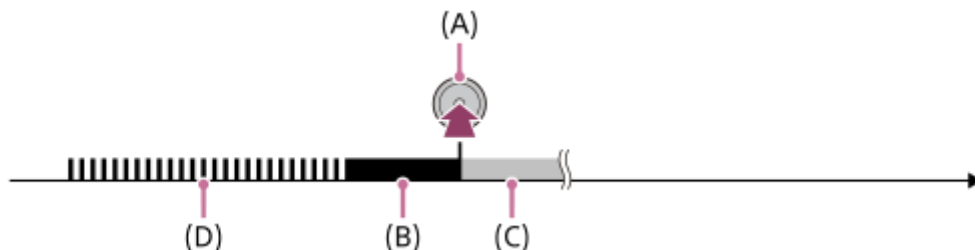

(A): The point when the MOVIE button is pressed

(B): Recorded section

(C): Recording to memory card in progress (You cannot start the next session of shooting.)

(D): Buffering in progress

## To redo shooting

You can cancel recording by selecting [Cancel] on the screen. However, the movie recorded up to the point you cancelled will be saved.

## Playback speed

The playback speed will vary as below depending on the assigned [**HFR** Frame Rate] and [**HFR** Record Setting].

<b>HFR</b> Frame Rate	<b>HFR</b> Record Setting		
	24p 50M*	30p 50M/25p 50M	60p 50M/50p 50M
240fps/250fps	10 times slower	8 times slower/10 times slower	4 times slower/5 times slower
480fps/500fps	20 times slower	16 times slower/20 times slower	8 times slower/10 times slower
960fps/1000fps	40 times slower	32 times slower/40 times slower	16 times slower/20 times slower

\* Only when [NTSC/PAL Selector] is set to NTSC.

## [**HFR** Priority Setting] and shooting duration

<b>HFR</b> Priority Setting	<b>HFR</b> Frame Rate	Effective pixel number read out from image sensor	Shooting duration
Quality Priority	240fps/250fps	1824×1026	Approx. 4 seconds
	480fps/500fps	1824×616	Approx. 3 seconds
	960fps/1000fps	1244×420	
Shoot Time Priority	240fps/250fps	1824×616	Approx. 7 seconds
	480fps/500fps	1292×436	Approx. 7 seconds/Approx. 6 seconds

HFR Priority Setting	HFR Frame Rate	Effective pixel number read out from image sensor	Shooting duration
	960fps/1000fps	912×308	Approx. 6 seconds

## Playback time

For example, if you shoot for approx. 4 seconds with [**HFR** Record Setting] set to [24p 50M]\*, [**HFR** Frame Rate] set to [960fps], and [**HFR** Priority Setting] set to [Shoot Time Priority], the playback speed will be 40 times slower and the playback time will be approx. 160 seconds (approx. 2 minutes and 40 seconds).

### Note

- Sound will not be recorded.
- The movie will be recorded in XAVC S HD format.
- It may take time for recording to finish after you press the MOVIE button. Wait until the screen switches to the shooting standby screen to start the next shooting.

## Related Topic

- [Movie recording formats](#)
- [Memory cards that can be used](#)
- [HFR \(High Frame Rate\): Exposure Mode](#)

## Capturing still images while recording movies (Dual Rec)

You can capture still images while recording movies without stopping recording. Use Dual Rec when you want to record both movies and still images at the same time.

- 1 Press the **MOVIE** button to start recording the movie.



- 2 Press the shutter button to capture a still image.

- If you press the shutter button halfway down, the remaining number of still images you can shoot will be displayed on the screen.
- While shooting still images, the message [CAPTURE] is displayed on the screen.

- 3 Press the **MOVIE** button again to finish recording the movie.

### Hint

- The image size or image quality of the still images can be selected from MENU →  2 (Camera Settings2) → [Img. Size(Dual Rec)]/[Quality(Dual Rec)].

### Note

- Dual Rec may be unavailable depending on the recording setting or mode setting.
- When [Px Proxy Recording] is set to [On], Dual Rec is unavailable.
- Depending on the memory card you use, it may take a while to record a still image.
- The shutter button sound may be recorded.
- You cannot use the flash while using Dual Rec.

### Related Topic

- [Quality\(Dual Rec\)](#)
- [Img. Size\(Dual Rec\)](#)
- [Auto Dual Rec](#)

- Shooting still images
- Shooting movies

4-725-901-11(2) Copyright 2017 Sony Corporation



Digital Still Camera  
DSC-RX10M4

## Quality(Dual Rec)

---

Selects the quality of still images to be shot while recording movies.

**1** MENU →  2 (Camera Settings2) → [Quality(Dual Rec)] → desired setting.

### Menu item details

Extra fine/Fine/Standard

Digital Still Camera  
DSC-RX10M4

## Img. Size(Dual Rec)

---

Selects the size of still images to be shot while recording movies.

**1** MENU →  **2** (Camera Settings2) → [Img. Size(Dual Rec)] → desired setting.



### Menu item details

L: 17M/M: 7.5M/S: 4.2M

Digital Still Camera  
DSC-RX10M4

## Auto Dual Rec

Sets whether or not to automatically shoot still images when shooting movies. Shoots when impressive compositions, including people, are detected. This function may also record versions of the automatically shot images that have been trimmed into optimal compositions. When a trimmed image is recorded, both the image before trimming and the trimmed image will be recorded.

- 1 MENU →  2 (Camera Settings2) → [Auto Dual Rec] → desired setting.
- 2 Press the **MOVIE** button to start movie recording.
  - Still images will be shot automatically. While capturing a still image, the message [CAPTURE] is displayed on the monitor.
- 3 Press the **MOVIE** button again to finish movie recording.
  - To view the movies and still images recorded, press the  (Playback) button.

### Menu item details

#### Off:

Auto Dual Rec is not performed.

#### On: Shoot. Frequency Low/On: Shoot. Frequency Standard/On: Shoot. Frequency High:

Auto Dual Rec is performed with the specified shooting frequency.

- The positions, orientation, expressions of faces are detected in order to shoot still images with the impressive compositions.

#### Hint

- If you want to change the size or quality of still images, use MENU →  2 (Camera Settings2) → [Img. Size(Dual Rec)]/[Quality(Dual Rec)].
- Even when [Auto Dual Rec] is set to On, you can record still images by pressing the shutter button.

#### Note

- Depending on the recording conditions, still images may not be shot with the optimal timing.



### Related Topic

- [Capturing still images while recording movies \(Dual Rec\)](#)
- [Auto Obj. Framing \(still image\)](#)

Digital Still Camera  
DSC-RX10M4

## Proxy Recording

Sets whether to simultaneously record low-bit-rate proxy movies when recording XAVC S movies. Since proxy movies are small in file size, they are suitable for transferring to smartphones or uploading to websites.

1 MENU →  2 (Camera Settings2) → [ Proxy Recording] → desired setting.

### Menu item details

#### On :

Proxy movies are simultaneously recorded.





#### Off :

Proxy movies are not recorded.

#### Hint

- Proxy movies are recorded in the XAVC S HD format (1280×720) at 9 Mbps. The frame rate of the proxy movie is the same as that of the original movie.
- Proxy movies are not displayed on the playback screen (single-image playback screen or image index screen).  is displayed over movies for which a proxy movie was simultaneously recorded.

#### Note

- Proxy movies cannot be played back on this camera.
- Proxy recording is not available in the following situations.
  - When [ File Format] is set to [AVCHD]
  - When [ File Format] is set to [XAVC S HD] and [ Record Setting] is set to [120p]/[100p]
  - When [ SteadyShot] is set to [Intelligent Active]
- Deleting/protecting movies that have proxy movies removes/protects both the original and proxy movies. You cannot delete/protect only original movies or proxy movies.
- Movies cannot be edited on this camera.

### Related Topic



- [Snd to Smrtphn Func: Sending Target \(proxy movies\)](#)
- [Movie recording formats](#)
- [Playing back images on the image index screen \(Image Index\)](#)
- [Memory cards that can be used](#)

Digital Still Camera  
DSC-RX10M4

## AF drive speed (movie)

---

You can switch focusing speed when using autofocus in movie mode.

1 MENU →  2 (Camera Settings2) →  AF drive speed] → desired setting.

### Menu item details

**Fast:**

Sets the AF drive speed to fast. This mode is suitable for shooting active scenes, such as sports.

**Normal:**

Sets the AF drive speed to normal.

**Slow:**

Sets the AF drive speed to slow. With this mode, the focus switches smoothly when the subject to be focused is changed.

**Note**



- When [ Record Setting] is set to [120p]/[100p], [ AF drive speed] cannot be used.

Digital Still Camera  
DSC-RX10M4

## AF Track Sens (movie)

---

You can set the AF sensitivity in movie mode.

1 MENU →  2 (Camera Settings2) →  AF Track Sens] → desired setting.

### Menu item details

#### Responsive:

Sets the AF sensitivity to high. This mode is useful when recording movies in which the subject is moving quickly.

#### Standard:

Sets the AF sensitivity to normal. This mode is useful when there are obstacles in front of the subject or in crowded places.



#### Note

- When  Record Setting] is set to [120p]/[100p],  AF Track Sens] cannot be used.

Digital Still Camera  
DSC-RX10M4

## Auto Slow Shut. (movie)

Sets whether or not to adjust the shutter speed automatically when recording movies if the subject is dark.

1 MENU →  2 (Camera Settings2) → [ Auto Slow Shut.] → desired setting.

### Menu item details



#### On:

Uses Auto Slow Shutter. The shutter speed automatically slows when recording in dark locations. You can reduce noise in the movie by using a slow shutter speed when recording in dark locations.

#### Off:

Does not use Auto Slow Shutter. The recorded movie will be darker than when [On] is selected, but you can record movies with smoother motion and less object blur.

#### Note

- [ Auto Slow Shut.] does not function in the following situations:
  - During High Frame Rate shooting
  -  (Shutter Priority)
  -  (Manual Exposure)
  - When [ISO] is set to other than [ISO AUTO]

Digital Still Camera  
DSC-RX10M4

## Audio Recording

---

Sets whether to record sounds when shooting movies. Select [Off] to avoid recording the sounds of the lens and the camera operating.

**1** MENU →  **2** (Camera Settings2) → [Audio Recording] → desired setting.

### Menu item details

**On:**

Records sound (stereo).

**Off:**

Does not record sound.



Digital Still Camera  
DSC-RX10M4

## Audio Rec Level

---

You can adjust the audio recording level while checking the level meter.

- 1 MENU →  2 (Camera Settings2) → [Audio Rec Level].
- 2 Select the desired level using the right/left sides of the control wheel.

### Menu item details

+:

Turns up the audio recording level.

-:

Turns down the audio recording level.

**Reset:**

Resets the audio recording level to the default setting.

#### Hint

- When you record audio movies with loud volumes, set [Audio Rec Level] to a lower sound level. Doing so enables you to record more realistic audio. When you record audio movies with lower volumes, set [Audio Rec Level] to a greater sound level to make the sound easier to hear.

#### Note

- Regardless of the [Audio Rec Level] settings, the limiter always operates.
- [Audio Rec Level] is available only when the shooting mode is set to movie mode.
- [Audio Rec Level] is unavailable during High Frame Rate shooting.
- The [Audio Rec Level] settings are applied for both the internal microphone and the  (microphone) terminal input.

Digital Still Camera  
DSC-RX10M4

## Audio Level Display

---

Sets whether to display the audio level on the screen.

1 MENU →  2 (Camera Settings2) → [Audio Level Display] → desired setting.

### Menu item details

**On:**

Displays the audio level.

**Off:**

Does not display the audio level.

**Note**

- The audio level is not displayed in the following situations:
  - When [Audio Recording] is set to [Off].
  - When DISP (Display Setting) is set to [No Disp. Info.].
  - During High Frame Rate shooting
- The audio level is also displayed while shooting stand-by in movie recording mode.

Digital Still Camera  
DSC-RX10M4

## Audio Out Timing

---

You can set echo cancellation during audio monitoring and prevent undesirable deviations between video and audio during HDMI output.

**1** MENU →  **2** (Camera Settings2) → [Audio Out Timing] → desired setting.

### Menu item details

**Live:**

Outputs audio without delay. Select this setting when audio deviation is a problem during audio monitoring.

**Lip Sync:**

Outputs audio and video in sync. Select this setting to prevent undesirable deviations between video and audio.

Digital Still Camera  
DSC-RX10M4

## Wind Noise Reduct.

---

Sets whether or not to reduce wind noise by cutting the low-range sound of the input audio from the built-in microphone.

**1** MENU →  2 (Camera Settings2) → [Wind Noise Reduct.] → desired setting.

### Menu item details

**On:**

Reduces wind noise.

**Off:**



Does not reduce wind noise.



**Note**

- Setting this item to [On] where wind is not blowing sufficiently hard may cause normal sound to be recorded with too low volume.
- When an external microphone (sold separately) is used, [Wind Noise Reduct.] does not function.

Digital Still Camera  
DSC-RX10M4

## SteadyShot (movie)

Sets [  SteadyShot] effect when shooting movies. If you set the [  SteadyShot] effect to [Off] when using a tripod (sold separately), a natural image is produced.

1 MENU →  2 (Camera Settings2) → [  SteadyShot] → desired setting.

### Menu item details

#### Intelligent Active:

Provides a more powerful SteadyShot effect than [Active].

#### Active:

Provides a more powerful SteadyShot effect.



#### Standard:

Reduces camera shake under stable movie shooting conditions.

#### Off:

Does not use [  SteadyShot].

#### Note



- If you change the setting for [  SteadyShot], the angle of view will change.
- [Intelligent Active] and [Active] cannot be selected when [  File Format] is set to [XAVC S 4K].

Digital Still Camera  
DSC-RX10M4

## Marker Display (movie)

---

Sets whether or not to display markers set using [  Marker Settings] on the monitor or the viewfinder while shooting movies.

1 MENU →  (Camera Settings2) → [  Marker Display] → desired setting.

### Menu item details

**On:**

Markers are displayed. The markers are not recorded.

**Off:**

No marker is displayed.

**Note**

- The markers are displayed when the mode dial is set to  ( Movie) or when shooting movies.
- You cannot display markers when using [Focus Magnifier].
- The markers are displayed on the monitor or viewfinder. (You cannot output the markers.)

---

### Related Topic



- [Marker Settings \(movie\)](#)

Digital Still Camera  
DSC-RX10M4

## Marker Settings (movie)

---

Sets the markers to be displayed while shooting movies.

1 MENU →  2 (Camera Settings2) → [ Marker Settings] → desired setting.

### Menu item details

**Center:**

Sets whether or not to display the center marker in the center of the shooting screen.

[Off]/[On]

**Aspect:**

Sets the aspect marker display.

[Off]/[4:3]/[13:9]/[14:9]/[15:9]/[1.66:1]/[1.85:1]/[2.35:1]

**Safety Zone:**

Sets the safety zone display. This becomes the standard range that can be received by a general household TV.

[Off]/[80%]/[90%]

**Guideframe:**

Sets whether or not to display the guide frame. You can verify whether the subject is level or perpendicular to the ground.

[Off]/[On]

**Hint**

- You can display several markers at the same time.
- Place the subject on the cross point of the [Guideframe] to make a balanced composition.

Digital Still Camera  
DSC-RX10M4

## Video Light Mode

---

Sets the illumination setting for the HVL-LBPC LED light (sold separately).

**1** MENU →  2 (Camera Settings2) → [Video Light Mode] → desired setting.

### Menu item details

**Power Link:**

The video light turns on/off in sync with the ON/OFF operation of this camera.

**REC Link:**

The video light turns on/off in sync with movie recording start/stop.

**REC Link&STBY:**

The video light turns on when movie recording starts and dims when not recording (STBY).

**Auto:**

The video light automatically turns on when it is dark.



Digital Still Camera  
DSC-RX10M4

## Movie w/ shutter

---

You can start or stop recording movies by pressing the shutter button, which is bigger and easier to press than the MOVIE (Movie) button.

1 MENU →  2 (Camera Settings2) → [Movie w/ shutter] → desired setting.

### Menu item details

**On:**  
Enables movie recording using the shutter button when the shooting mode is set to [Movie] or during High Frame Rate shooting.

**Off:**  
Disables movie recording using the shutter button.

#### Hint

- When [Movie w/ shutter] is set to [On], you can still start or stop recording movies using the MOVIE button.
- When [Movie w/ shutter] is set to [On], you can use the shutter button to start or stop recording movies on an external recording/playback device using [ REC Control].

---



### Related Topic

- [Shooting movies](#)

Digital Still Camera  
DSC-RX10M4

## Shutter Type (still image)

You can set whether to shoot with a mechanical shutter or an electronic shutter.

1 MENU →  2 (Camera Settings2) → [ Shutter Type] → desired setting.

### Menu item details

#### Auto:

The shutter type is automatically switched based on the shooting conditions and shutter speed.



#### Mechanical Shut.:

Shoot with the mechanical shutter only.





#### Electronic Shut.:

Shoot with the electronic shutter only.

#### Hint

- In the following situations, set the [ Shutter Type] to [Auto] or [Electronic Shut.].
  - When shooting with a high-speed shutter in a bright environment such as outside in bright sunlight, the beach, or snowy mountains.
  - When you want to increase the speed of continuous shooting.
- In the following situations, set the [ Shutter Type] to [Auto] or [Mechanical Shut.].
  - When you want to use the flash with a shutter speed faster than 1/100 second.
  - When you are concerned about distortion in the image due to the movement of the subject or the movement of the camera.

#### Note

- When shooting with the electronic shutter, there may be distortion in the image due to the movement of the subject or the camera itself.
- During shooting with the electronic shutter, band-like light-and-dark shading may appear when shooting under flickering light such as fluorescent light or instantaneous light (such as the flash of another camera).
- In rare cases, the shutter sound may be produced when the power is turned off even if the [ Shutter Type] is set to [Electronic Shut.]. However, this is not a malfunction.
- In the following situations, the mechanical shutter will be activated even if the [ Shutter Type] is set to [Electronic Shut.].
  - When capturing a basic white color in [Custom Setup] for [White Balance]
  - [Face Registration]
- The following functions are unavailable when the [ Shutter Type] is set to [Electronic Shut.].
  -  Long Exposure NR
  - Bulb shooting
- When using an external flash, the highest shutter speed you can set is 1/4000 seconds. However, because this shutter speed uses the electronic shutter, a belt-like contrast may be recorded on the image. If this occurs, set the [ Shutter Type] to [Mechanical Shut.].

### Related Topic

- [Using flash](#)



Digital Still Camera  
DSC-RX10M4

## Release w/o Card

---

Sets whether the shutter can be released when no memory card has been inserted.

**1** MENU →  2 (Camera Settings2) → [Release w/o Card] → desired setting.

### Menu item details

**Enable:**

Releases the shutter even if no memory card has been inserted.

**Disable:**

Does not release the shutter when no memory card has been inserted.

**Note**



- When no memory card has been inserted, the images shot will not be saved.
- The default setting is [Enable]. It is recommended that you select [Disable] prior to actual shooting.

Digital Still Camera  
DSC-RX10M4

## SteadyShot (still image)

---

Sets whether or not to use the SteadyShot function.

**1** MENU →  2 (Camera Settings2) → [ SteadyShot] → desired setting.

### Menu item details

**On:**

Uses [ SteadyShot].

**Off:**

Does not use [ SteadyShot].

We recommend that you set the camera to [Off] when using a tripod.

Digital Still Camera  
DSC-RX10M4

## Rng. of Zoom Assist

---

Selects how much to zoom out with the [Zoom Assist] function.

**1** MENU →  **2** (Camera Settings2) → [Rng. of Zoom Assist] → desired setting.

### Menu item details

**S:**

Zooms out a small amount.

**M:**

Zooms out a medium amount.

**L:**

Zooms out a large amount.

---

### Related Topic

- [Zoom Assist](#)

Digital Still Camera  
DSC-RX10M4

## Zoom Setting

---

You can select the zoom setting of the product.

**1** MENU →  2 (Camera Settings2) → [Zoom Setting] → desired setting.

### Menu item details

#### Optical zoom only:

Limits the zoom range to the optical zoom. You can use the Smart Zoom function if you set [  Image Size] to [M], [S] or [VGA].

#### On:ClearImage Zoom:

Select this setting to use Clear Image Zoom. Even if the zoom range exceeds the optical zoom, the product magnifies images within the range in which image quality does not deteriorate significantly.

#### On:Digital Zoom:

When the zoom range of the Clear Image Zoom is exceeded, the product magnifies images to the largest scale. However, the image quality will deteriorate.

#### Note

- Set [Optical zoom only] if you want to magnify images within the range in which image quality does not deteriorate.

---

### Related Topic

- [The zoom features available with this product](#)
- [About zoom scale](#)
- [Zoom Speed](#)

Digital Still Camera  
DSC-RX10M4

## Zoom Speed

---

Sets the zoom speed of the camera's zoom lever.

1 MENU →  2 (Camera Settings2) → [Zoom Speed] → desired setting.

### Menu item details

#### Normal:

Sets the zoom speed of the zoom lever to normal.

#### Fast:

Sets the zoom speed of the zoom lever to fast.

#### Hint

- The [Zoom Speed] settings are also used when you are zooming with a remote controller (sold separately) connected to the camera.

#### Note

- Selecting [Fast] increases the likelihood that the zoom sound will be recorded.

---

### Related Topic

- [Zoom](#)
- [The zoom features available with this product](#)
- [Zoom Setting](#)



Digital Still Camera  
DSC-RX10M4

## Zoom Ring Rotate

---

Assigns zoom in (T) or zoom out (W) functions to the rotational directions of the lens ring to which the zoom function has been assigned.

1 MENU →  2 (Camera Settings2) → [Zoom Ring Rotate] → desired setting.

### Menu item details

#### Left(W)/Right(T):

Assigns zoom out (W) function to left-handed rotation and zoom-in (T) function to right-handed rotation.

#### Right(W)/Left(T):

Assigns zoom in (T) function to left-handed rotation and zoom-out (W) function to right-handed rotation.

---

### Related Topic

- [Lens Ring Setup](#)

Digital Still Camera  
DSC-RX10M4

## Zoom Func. on Ring

---

Sets the zoom functions when using the lens ring to change zoom scales.

1 MENU →  2 (Camera Settings2) → [Zoom Func. on Ring] → desired setting.

### Menu item details

**Standard:**

Zooms in/out smoothly when you operate the zoom by turning the lens ring.

**Quick:**

Zooms in/out to an angle of view corresponding to how far the lens ring has been rotated.

**Step:**

Zooms in/out at certain angle steps when you operate the zoom by turning the lens ring.

**Note**

- In the following situations, the zoom function activates as if [Zoom Func. on Ring] is set to [Standard], even if it is set to [Step].
  - When using the W/T (zoom) lever to change the zoom scale.
  - When recording movies.
  - When using zoom functions other than the optical zoom.
- Selecting [Quick] increases the likelihood that the zoom sound will be recorded.

## DISP Button (Monitor/Finder)

Allows you to set the screen display modes that can be selected using DISP (Display Setting) in shooting mode.

1 MENU →  2 (Camera Settings2) → [DISP Button] → [Monitor] or [Finder] → desired setting → [Enter].

The items marked with  are available.

### Menu item details

#### Graphic Display :

Shows basic shooting information. Graphically shows the shutter speed and aperture value.

#### Display All Info. :

Shows recording information.

#### No Disp. Info. :

Does not show recording information.

#### Histogram :

Displays the luminance distribution graphically.

#### Level :

Indicates whether the product is level in both the front-back **(A)** and horizontal **(B)** directions. When the product is level in both directions, the indicator turns to green.

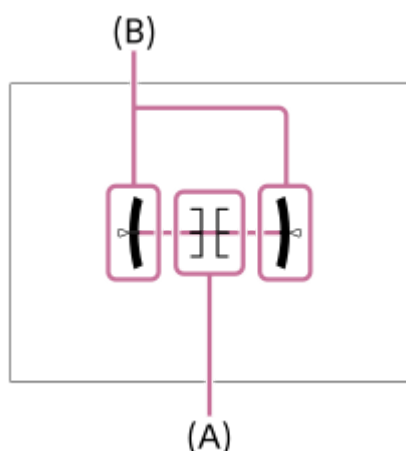

#### For viewfinder\*:

Displays information suited for shooting with the viewfinder.

\* This screen mode is available only in the setting for [Monitor].

#### Note

- If you tilt the product forward or backward by a large degree, the level error will be great.
- The product may have a margin of error of almost  $\pm 1^\circ$  even when the inclination is corrected by the level.

### Related Topic

- [Switching the screen display \(while shooting/during playback\)](#)



Digital Still Camera  
DSC-RX10M4

## FINDER/MONITOR

---

Sets the method for switching the display between Electronic Viewfinder and the screen.

1 MENU →  2 (Camera Settings2) → [FINDER/MONITOR] → desired setting.

### Menu item details

#### Auto:

When you look into the Electronic Viewfinder, the eye sensor reacts and the display is switched to the Electronic Viewfinder automatically.

#### Viewfinder(Manual):

The screen is turned off and the image is displayed only in the Electronic Viewfinder.

#### Monitor(Manual):

The Electronic Viewfinder is turned off and the image is always displayed on the screen.

#### Hint

- You can assign the [FINDER/MONITOR] function to your preferred key.  
MENU →  2 (Camera Settings2) → [Custom Key(Shoot.)] → set [Finder/Monitor Sel.] to the preferred key.
- To turn off automatic switching of the display using the eye sensor, set [FINDER/MONITOR] to [Viewfinder(Manual)] or [Monitor(Manual)].

#### Note

- When the monitor is pulled out, the eye sensor of the camera will not detect your eye approaching even if [FINDER/MONITOR] is set to [Auto]. The image will continue to be displayed on the monitor.

---

### Related Topic

- [Custom Key\(Shoot.\)/Custom Key\(PB\)](#)

Digital Still Camera  
DSC-RX10M4

## Zebra

The zebra pattern will appear over part of an image if the brightness level of that part meets the IRE level that you set. Use this zebra pattern as a guide to adjust the brightness.

**1** MENU →  2 (Camera Settings2) → [Zebra] → desired setting.

### Menu item details

#### Off:

Does not display the zebra pattern.

#### 70/75/80/85/90/95/100/100+/Custom1/Custom2:

Adjusts the brightness level.

#### Hint

- You can register values to check the correct exposure or overexposure as well as the brightness level for [Zebra]. The settings for correct exposure confirmation and overexposure confirmation are registered to [Custom1] and [Custom2] respectively in the default settings.
- To check the correct exposure, set a standard value and the range for the brightness level. The zebra pattern will appear on areas that fall within the range you set.
- To check the overexposure, set a minimum value for the brightness level. The zebra pattern will appear over areas with a brightness level equal to or higher than the value you set.

#### Note

- The zebra pattern is not displayed on devices connected via HDMI.

Digital Still Camera  
DSC-RX10M4

## Grid Line

---

Sets whether the grid line is displayed or not. The grid line will help you to adjust the composition of images.

**1** MENU →  2 (Camera Settings2) → [Grid Line] → **desired setting.**

### Menu item details

#### Rule of 3rds Grid:

Place main subjects close to one of the grid lines that divide the image into thirds for a well-balanced composition.

#### Square Grid:

Square grids make it easier to confirm the horizontal level of your composition. This is suitable to determine the quality of the composition when shooting landscape, close-up, or duplicated images.

#### Diag. + Square Grid:

Place a subject on the diagonal line to express an uplifting and powerful feeling.

#### Off:

Does not display the grid line.

Digital Still Camera  
DSC-RX10M4

## Exposure Set. Guide

---

You can set whether to display a guide when you change the exposure.

1 MENU →  2 (Camera Settings2) → [Exposure Set. Guide] → desired setting.

### Menu item details

**Off:**

Does not display the guide.

**On:**

Displays the guide.

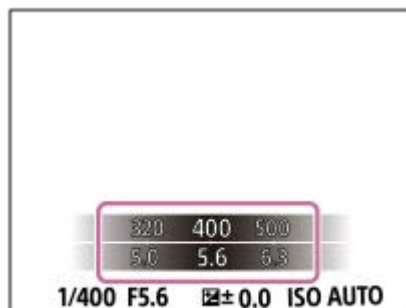



Digital Still Camera  
DSC-RX10M4

## Live View Display

Sets whether or not to show images altered with effects of the exposure compensation, white balance, [Creative Style], or [Picture Effect] on the screen.

1 MENU →  2 (Camera Settings2) → [Live View Display] → desired setting.

### Menu item details

#### Setting Effect ON:

Displays Live View in conditions close to what your picture will look like as a result of applying all your settings. This setting is useful when you want to shoot pictures while checking the results of the shot on the Live View screen.

#### Setting Effect OFF:

Displays Live View without the effects of exposure compensation, white balance, [Creative Style], or [Picture Effect]. When this setting is used, you can easily check the image composition.

Live View is always displayed with the appropriate brightness even in [Manual Exposure] mode.

When [Setting Effect OFF] is selected, the **VIEW** icon is displayed on the Live View screen.

#### Hint

- When you use a third-party flash, such as a studio flash, Live View Display may be dark for some shutter speed settings. When [Live View Display] is set to [Setting Effect OFF], Live View Display will be displayed brightly, so that you can easily check the composition.

#### Note

- [Live View Display] cannot be set to [Setting Effect OFF] in the following shooting modes:
  - [Intelligent Auto]
  - [Superior Auto]
  - [Sweep Panorama]
  - [Movie]
  - [High Frame Rate]
  - [Scene Selection]
- When [Live View Display] is set to [Setting Effect OFF], the brightness of the shot image will not be the same as that of the displayed Live View.

Digital Still Camera  
DSC-RX10M4

## Auto Review

---

You can check the recorded image on the screen right after the shooting. You can also set the display time for Auto Review.

1 MENU →  2 (Camera Settings2) → [Auto Review] → desired setting.

### Menu item details

#### 10 Sec/5 Sec/2 Sec:

Displays the recorded image on the screen right after shooting for the selected duration of time. If you perform a magnifying operation during Auto Review, you can check that image using the magnified scale.

#### Off:

Does not display the Auto Review.

#### Note

- When you use a function that performs image processing, the image before processing may be displayed temporarily, followed by the image after processing.
- The DISP (Display Setting) settings are applied for the Auto Review display.

---

### Related Topic

- [Enlarging an image being played back \(Enlarge Image\)](#)

## Custom Key(Shoot.)/Custom Key(PB)

You can assign a desired function to a desired key.

Some functions are available only when they are assigned to a custom key. For example, if you assign [Eye AF] to [Center Button] for [Custom Key(Shoot.)], you can easily recall [Eye AF] simply by pressing the center of the control wheel while shooting.

**1** MENU →  2 (Camera Settings2) → [Custom Key(Shoot.)] or [Custom Key(PB)].

**2** Select the key to which you want to assign the function on the selection screen, and press the center of the control wheel.

- The keys that can be assigned functions are different for [Custom Key(Shoot.)] and [Custom Key(PB)].
- You can assign the desired functions to the following keys.

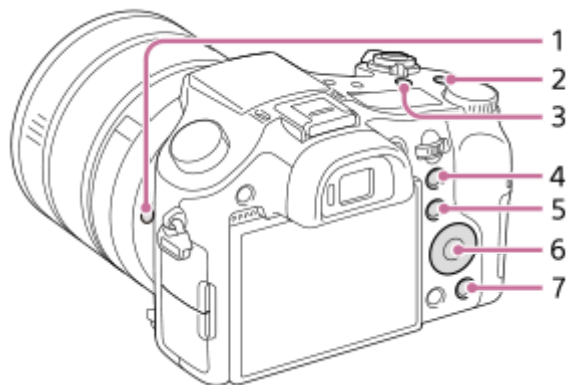

1. Focus Hold Button
2. Custom Button 1
3. Custom Button 2
4. AEL Button
5. Fn/  Button
6. Control Wheel/Center Button/Down Button/Left Button/Right Button
7. Custom Button 3

**3** Select the function to be assigned.

- The functions that can be assigned differ depending on the keys.

### Related Topic

- [Focus Standard](#)

Digital Still Camera  
DSC-RX10M4

## Function Menu Set.

---

You can assign the functions to be called up when you press the Fn (Function) button.

**1** MENU →  2 (Camera Settings2) → [Function Menu Set.] → **set a function to the desired location.**

- The functions that can be assigned are displayed on the setup item selection screen.

Digital Still Camera  
DSC-RX10M4

## Lens Ring Setup

You can zoom and focus more intuitively using the two lens rings (front and rear). Assigns the focus function or the zoom function to the front lens ring and rear lens ring.

1 MENU →  (Camera Settings2) → [Lens Ring Setup] → desired setting.

### Menu item details



 **Focus**  **Zoom:**

Assigns the focus function to the front lens ring and the zoom function to the rear lens ring.

 **Zoom**  **Focus:**

Assigns the zoom function to the front lens ring and the focus function to the rear lens ring.

#### Hint

- You can change which operation is associated with either rotational direction of the lens ring by selecting MENU →  (Camera Settings1) → [Focus Ring Rotate] or MENU →  (Camera Settings2) → [Zoom Ring Rotate].
- You can change the zoom function assigned to the lens ring by selecting MENU →  (Camera Settings2) → [Zoom Func. on Ring].

### Related Topic

- [Focus Ring Rotate](#)
- [Zoom Ring Rotate](#)
- [Zoom Func. on Ring](#)

Digital Still Camera  
DSC-RX10M4

## MOVIE Button

---

Sets whether or not to activate the MOVIE (Movie) button.

**1** MENU →  2 (Camera Settings2) → [MOVIE Button] → desired setting.

### Menu item details

**Always:**

Starts movie recording when you press the MOVIE button in any mode. (except when the mode dial is set to **HFR** (High Frame Rate).)

**Movie Mode Only:**

Starts movie recording when you press the MOVIE button only if the shooting mode is set to [ Movie] mode.

Digital Still Camera  
DSC-RX10M4

## Dial / Wheel Lock

---

You can set whether the dial and wheel will be locked by pressing and holding the Fn (Function) button.

1 MENU →  2 (Camera Settings2) → [Dial / Wheel Lock] → desired setting.

### Menu item details

**Lock:**

Locks the control dial and control wheel.

**Unlock:**

Does not lock the control dial or control wheel even if you press and hold the Fn (Function) button.

**Hint**

- You can release the lock by holding the Fn (Function) button down again.

**Note**

- When [ AF Area Regist.] is set to [On], [Dial / Wheel Lock] is fixed to [Unlock].

Digital Still Camera  
DSC-RX10M4

## Audio signals

---

Selects whether the product produces a sound or not.

**1** MENU →  **2** (Camera Settings2) → [Audio signals] → desired setting.

### Menu item details

**On:**

Sounds are produced for example when the focus is achieved by pressing the shutter button halfway down.

**Shutter:**

Only the shutter sound is produced.

**Off:**

Sounds are not produced.

**Note**

- If [Focus Mode] is set to [Continuous AF], the camera will not beep when it focuses on a subject.





Digital Still Camera  
DSC-RX10M4

## Write Date (still image)

---

Sets whether to record a shooting date on the still image.

1 MENU →  2 (Camera Settings2) → [ Write Date] → desired setting.

### Menu item details

**On:**

Records a shooting date.

**Off:**

Does not record a shooting date.

**Note**

- If you shoot images with the date once, you cannot delete the date from the images later.
- The dates are doubly printed if you set the product to print dates when printing the images using PCs or printers.
- The recorded time of the image cannot be superimposed on the image.
- [ Write Date] is not available for RAW images.

Digital Still Camera  
DSC-RX10M4

## Snd to Smrtphn Func: Send to Smartphone

You can transfer still images, XAVC S movies, or high-frame-rate movies to a smartphone and view them. The application PlayMemories Mobile must be installed on your smartphone.

**1 MENU** →  (**Network**) → **[Snd to Smrtphn Func]** → **[Send to Smartphone]** → **desired setting**.

- If you press the  (Send to Smartphone) button in playback mode, the setting screen for [Send to Smartphone] will appear.

**2 If the product is ready for the transfer, the information screen appears on the product. Connect the smartphone and the product using that information.**

- The setting method for connecting the smartphone and the product varies depending on the smartphone.



### Menu item details

#### Select on This Device:

Selects an image on the product to be transferred to the smartphone.

(1) Select from among [This Image], [All with this date] or [Multiple Images].

- The options displayed may differ depending on the View Mode selected on the camera.

(2) If you select [Multiple Images], select the desired images using the center of the control wheel, then press MENU → [Enter].

#### Select on Smartphone:

Displays all images recorded on the product's memory card on the smartphone.

#### Note

- You can only transfer images that are saved on the camera's memory card.
- You can select an image size to be sent to the smartphone from [Original], [2M] or [VGA]. To change the image size, refer to the following steps.
  - For Android smartphone  
Start PlayMemories Mobile, and change the image size by [Settings] → [Copy Image Size].
  - For iPhone/iPad  
Select PlayMemories Mobile in the setting menu, and change the image size by [Copy Image Size].
- RAW images are converted to JPEG format when they are sent.
- You cannot send AVCHD format movies.
- You cannot transfer XAVC S 4K movies or the original data of XAVC S HD movies recorded in [120p]/[100p] to a smartphone. You can only transfer proxy movies.

- Depending on the smartphone, the transferred movie may not be played back correctly. For example, the movie may not play smoothly, or there may be no sound.
- Depending on the format of the still image, movie, or high-frame-rate movie, it may not be possible to play it back on a smartphone.
- This product shares the connection information for [Send to Smartphone] with a device that has permission to connect. If you want to change the device that is permitted to connect to the product, reset the connection information by following these steps. MENU →  (Network) → [Wi-Fi Settings] → [SSID/PW Reset]. After resetting the connection information, you must register the smartphone again.
- When [Airplane Mode] is set to [On], you cannot connect this product and the smartphone. Set [Airplane Mode] to [Off].
- While you transfer many images or long movies, we recommend that you supply power to the camera from a wall outlet (wall socket) using the AC Adaptor (supplied).

---

## Related Topic

- [PlayMemories Mobile](#)
- [Controlling the camera using an Android smartphone \(QR code\)](#)
- [Controlling the camera using an Android smartphone \(SSID\)](#)
- [Controlling the camera using an iPhone or iPad \(QR code\)](#)
- [Controlling the camera using an iPhone or iPad \(SSID\)](#)
- [Sending images to an Android smartphone \(NFC One-touch Sharing\)](#)
- [Send to Smartphone Func: Sending Target \(proxy movies\)](#)
- [Airplane Mode](#)

Digital Still Camera  
DSC-RX10M4

## Snd to Smrtphn Func: Sending Target (proxy movies)

---

When transferring XAVC S video to a smartphone with [Send to Smartphone], you can set whether to transfer the low-bit-rate proxy movie or the high-bit-rate original movie.

1 MENU →  (Network) → [Snd to Smrtphn Func] → [ Sending Target] → desired setting.

### Menu item details

#### Proxy Only:

Transfers only proxy movies.

#### Original Only:

Transfers only original movies.

#### Proxy & Original:

Transfers both proxy and original movies.

#### Note

- You cannot transfer XAVC S 4K movies or the original data of XAVC S HD movies recorded in [120p]/[100p] to a smartphone. You can only transfer proxy movies.
- While you transfer many images or long movies, we recommend that you supply power to the camera from a wall outlet (wall socket) using the AC Adaptor (supplied).

---

### Related Topic

- [Snd to Smrtphn Func: Send to Smartphone](#)
- [Proxy Recording](#)

Digital Still Camera  
DSC-RX10M4

## Send to Computer

---

You can transfer images stored in the product to a computer connected to a wireless access point or wireless broadband router and easily make backup copies using this operation. Before starting this operation, install PlayMemories Home on your computer and register the access point on the product.

**1 Start your computer.**

**2 MENU** →  **(Network)** → **[Send to Computer]**.

### Note

- Depending on the application settings of your computer, the product will turn off after saving the images to your computer.
- You can transfer images from the product to only one computer at a time.
- If you want to transfer images to another computer, connect the product and the computer via a USB connection and follow the instructions in PlayMemories Home.
- Proxy movies cannot be transferred.

---

### Related Topic

- [Installing PlayMemories Home](#)
- [Wi-Fi Settings: WPS Push](#)
- [Wi-Fi Settings: Access Point Set.](#)

Digital Still Camera  
DSC-RX10M4

## View on TV

You can view images on a network-enabled TV by transferring them from the product without connecting the product and TV with a cable. For some TVs, you may need to perform operations on the TV. For details, refer to the operating instructions supplied with the TV.

1 MENU →  (Network) → [View on TV] → **desired device to be connected.**

2 When you want to play back images using slideshow, press the center of the control wheel.

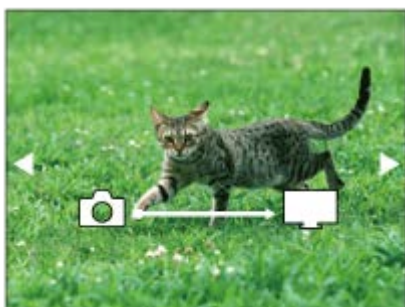

- To display the next/previous image manually, press the right/left sides of the control wheel.
- To change the device to be connected, press the down side of the control wheel, then select [Device list].

## Slideshow settings

You can change the slideshow settings by pressing the down side of the control wheel.

### Playback Selection:

Selects the group of images to be shown.

### Folder View(Still):

Selects from [All] and [All in Folder].

### Date View:

Selects from [All] and [All in Date Rng.].

### Interval:

Selects from [Short] and [Long].

### Effects\*:

Selects from [On] and [Off].

### Playback Image Size:

Selects from [HD] and [4K].

\* The settings are effective only for BRAVIA TV which is compatible with the functions.

### Note

- You can use this function on a TV that supports DLNA renderer.
- You can view images on a Wi-Fi Direct-enabled TV or network-enabled TV (including wired network-enabled TVs).
- If you connect TV and this product and do not use Wi-Fi Direct, you need to register your access point first.
- Displaying the images on the TV may take time.
- Movies cannot be shown on a TV via Wi-Fi. Use an HDMI cable (sold separately).

**Related Topic**

- [Wi-Fi Settings: WPS Push](#)
- [Wi-Fi Settings: Access Point Set.](#)

4-725-901-11(2) Copyright 2017 Sony Corporation

Digital Still Camera  
DSC-RX10M4

## Ctrl w/ Smartphone

---

Sets the condition for connecting the camera to a smartphone.

- 1 **MENU** →  **(Network)** → **[Ctrl w/ Smartphone]** → **desired setting**.

### Menu item details

#### Ctrl w/ Smartphone:

Sets whether to connect the camera and a smartphone using Wi-Fi. ([On]/[Off])

#### **Connection:**

Displays the QR code or SSID used to connect the camera to a smartphone.

#### **Always Connected:**

Sets whether to keep the camera connected to a smartphone. If this item is set to [On], once you connect the camera to a smartphone, it will remain connected to the smartphone at all times. If it is set to [Off], the camera will connect to a smartphone only when the connection procedure is performed.

#### **Note**

- If [Always Connected] is set to [On], the power consumption will be greater than when it is set to [Off].

---

### Related Topic

- [Controlling the camera using an Android smartphone \(NFC One-touch remote\)](#)
- [Controlling the camera using an Android smartphone \(QR code\)](#)
- [Controlling the camera using an Android smartphone \(SSID\)](#)
- [Controlling the camera using an iPhone or iPad \(QR code\)](#)
- [Controlling the camera using an iPhone or iPad \(SSID\)](#)
- [Snd to Smrtphn Func: Send to Smartphone](#)



Digital Still Camera  
DSC-RX10M4

## Airplane Mode

---

When you board an airplane, etc., you can temporarily disable all the wireless-related functions including Wi-Fi.

**1** MENU →  (Network) → [Airplane Mode] → **desired setting.**

If you set [Airplane Mode] to [On], an airplane mark will be displayed on the screen.

Digital Still Camera  
DSC-RX10M4

## Wi-Fi Settings: WPS Push

---

If your access point has a Wi-Fi Protected Setup (WPS) button, you can register the access point to this product easily.

- 1 **MENU** →  **(Network)** → **[Wi-Fi Settings]** → **[WPS Push]**.
- 2 **Push the Wi-Fi Protected Setup (WPS) button on the access point to connect.**

### Note

- [WPS Push] works only if the security setting of your access point is set to WPA or WPA2 and your access point supports the Wi-Fi Protected Setup (WPS) button method. If the security setting is set to WEP or your access point does not support the Wi-Fi Protected Setup (WPS) button method, perform [Access Point Set].
- For details about the available functions and settings of your access point, see the access point operating instructions or contact the administrator of the access point.
- A connection may not be possible or the communication distance may be shorter depending on the surrounding conditions, such as the type of wall material and the presence of obstructions or radio waves between the product and access point. In this case, change the location of the product or move the product closer to the access point.

---

### Related Topic

- [Wi-Fi Settings: Access Point Set.](#)

## Wi-Fi Settings: Access Point Set.

You can register your access point manually. Before starting the procedure, check the SSID name of the access point, security system, and password. The password may be preset in some devices. For details, see the access point operating instructions, or consult the access point administrator.

1 MENU →  (Network) → [Wi-Fi Settings] → [Access Point Set.].

2 Select the access point you want to register.

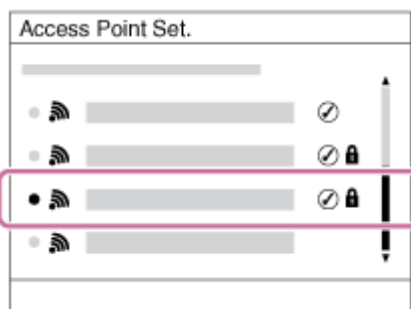

**When the desired access point is displayed on the screen:** Select the desired access point.

**When the desired access point is not displayed on the screen:** Select [Manual Setting] and set the access point.

- If you select [Manual Setting], input the SSID name of the access point, then select the security system.

3 Input the password, and select [OK].

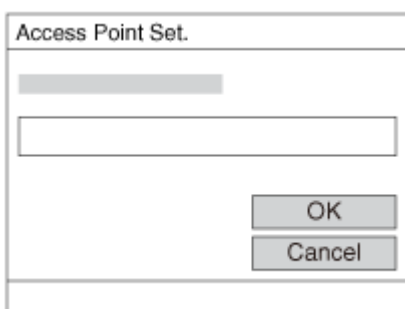

- Access points without the  mark do not require a password.

4 Select [OK].

### Other setting items

Depending on the status or the setting method of your access point, you may want to set more items.

#### WPS PIN:

Displays the PIN code you enter into the connected device.

#### Priority Connection:

Select [On] or [Off].

#### IP Address Setting:

Select [Auto] or [Manual].

**IP Address:**

If you are entering the IP address manually, enter the set address.

**Subnet Mask/Default Gateway:**

If you have set [IP Address Setting] to [Manual], enter each address according to your network environment.

**Note**

- To give the registered access point priority in the future, set [Priority Connection] to [On].

---

**Related Topic**

- [Wi-Fi Settings: WPS Push](#)
- [How to use the keyboard](#)

Digital Still Camera  
DSC-RX10M4

## Wi-Fi Settings: Disp MAC Address

---

Displays the MAC address of this product.

**1** MENU →  (Network) → [Wi-Fi Settings] → [Disp MAC Address].

Digital Still Camera  
DSC-RX10M4

## Wi-Fi Settings: SSID/PW Reset

---

This product shares the connection information for [Send to Smartphone] and [  Connection] with a device that has permission to connect. If you want to change the device that is permitted to connect, reset the connection information.

**1** MENU →  (Network) → [Wi-Fi Settings] → [SSID/PW Reset] → [OK].

### Note

- If you connect this product to a smartphone after resetting the connection information, you must make the settings for the smartphone again.

---

### Related Topic

- [Snd to Smrtphn Func: Send to Smartphone](#)
- [Ctrl w/ Smartphone](#)

Digital Still Camera  
DSC-RX10M4

## Bluetooth Settings

---

Controls the settings for connecting the camera to a smartphone via a Bluetooth connection. You need to pair the camera and smartphone before using the location information link function.

If you want to pair the camera and smartphone in order to use the location information link function, refer to “Loc. Info. Link Set..”

① MENU →  (Network) → [Bluetooth Settings] → desired setting.

### Menu item details

#### Bluetooth Function (On/Off):

Sets whether to activate or not the Bluetooth function of the camera.

#### Pairing:

Displays the screen for pairing the camera and smartphone using PlayMemories Mobile.

#### Disp Device Address:

Displays the BD address of the camera.

---

### Related Topic

- [Loc. Info. Link Set.](#)

Digital Still Camera  
DSC-RX10M4

## Loc. Info. Link Set.

You can use the application PlayMemories Mobile to obtain location information from a smartphone that is connected with your camera using Bluetooth communication. You can record the obtained location information when shooting images.

### Preparation in advance









To use the location information linking function of the camera, the application PlayMemories Mobile is required. If "Location Information Linkage" is not displayed on the top page of PlayMemories Mobile, you need to perform the following steps beforehand.

1. Install PlayMemories Mobile on your smartphone.
  - You can install PlayMemories Mobile from the application store of your smartphone. If you have already installed the application, update it to the latest version.
2. Transfer a pre-recorded image to your smartphone using the [Send to Smartphone] function of the camera.
  - After you transfer an image recorded using the camera to your smartphone, "Location Information Linkage" will appear on the top page of the application.



### Operating procedure

: Operations performed on the smartphone

: Operations performed on the camera

1. : Confirm that the Bluetooth function of your smartphone is activated.
  - Do not perform the Bluetooth pairing operation on the smartphone setting screen. In steps 2 to 7, the pairing operation is performed using the camera and the application PlayMemories Mobile.
  - If you accidentally perform the pairing operation on the smartphone setting screen in step 1, cancel the pairing and then perform the pairing operation by following Steps 2 through 7 using the camera and the application PlayMemories Mobile.
2. : On the camera, select MENU →  (Network) → [Bluetooth Settings] → [Bluetooth Function] → [On].
3. : On the camera, select MENU →  (Network) → [Bluetooth Settings] → [Pairing].
4. : Launch PlayMemories Mobile on your smartphone and tap "Location Information Linkage."
  - If "Location Information Linkage" is not displayed, follow the steps in "Preparation in advance" above.
5. : Activate [Location Information Linkage] on the [Location Information Linkage] setting screen of PlayMemories Mobile.
6. : Follow the instructions on the [Location Information Linkage] setting screen of PlayMemories Mobile, and then select your camera from the list.
7. : Select [OK] when a message is displayed on the monitor of the camera.
  - Pairing of the camera and PlayMemories Mobile is complete.



8.  : On the camera, select MENU →  (Network) → [ Loc. Info. Link Set.] → [Location Info. Link] → [On].

-  (obtaining location information icon) will be displayed on the monitor of the camera. Location information obtained by your smartphone using GPS, etc., will be recorded when shooting images.

## Menu item details

### Location Info. Link:

Sets whether to obtain the location information by linking with a smartphone.

### Auto Time Correct.:

Sets whether to automatically correct the date setting of the camera using information from a linked smartphone.

### Auto Area Adjust.:

Sets whether to automatically correct the area setting of the camera using information from a linked smartphone.

## Icons displayed when obtaining the location information

 (Obtaining location information): The camera is obtaining the location information.

 (Location information cannot be obtained): The camera cannot obtain the location information.

 (Bluetooth connection available): Bluetooth connection with the smartphone is established.

 (Bluetooth connection unavailable): Bluetooth connection with the smartphone is not established.

### Hint

- Location information can be linked when PlayMemories Mobile is running on your smartphone even if the smartphone monitor is off. However, if the camera has been turned off for a while, location information may not be linked immediately when you turn the camera back on. In this case, location information will be linked immediately if you open the PlayMemories Mobile screen on the smartphone.
- When PlayMemories Mobile is not operating, such as when the smartphone is restarted, launch PlayMemories Mobile to resume location information linking.
- In the application PlayMemories Home, you can view images on a map by importing images with location information to your computer. For details, refer to Help for PlayMemories Home.
- If the location information linking function does not work properly, see the following notes and perform pairing again.
  - Confirm that the Bluetooth function of your smartphone is activated.
  - Confirm that the camera is not connected with other devices using the Bluetooth function.
  - Confirm that [Airplane Mode] for the camera is set to [Off].
  - Delete the pairing information for the camera registered in PlayMemories Mobile.
  - Execute [Reset Network Set.] of the camera.
- For more detailed video instructions, refer to the following support page.  
<http://www.sony.net/pmm/btg/>

### Note

- When you initialize the camera, the pairing information is also deleted. To perform pairing again, delete the pairing information for the camera registered in PlayMemories Mobile before trying again.
- The location information will not be recorded when it cannot be obtained, such as when the Bluetooth connection is disconnected.
- The camera can be paired with up to 15 Bluetooth devices, but can link the location information with that of only one smartphone. If you want to link the location information with that of another smartphone, turn off the [Location Information Linkage] function of the smartphone that is already linked.
- If the Bluetooth connection is unstable, remove any obstacles, such as people or metal objects from between the camera and the paired smartphone.
- When pairing the camera and your smartphone, be sure to use the [Location Information Linkage] menu on PlayMemories Mobile.

## Supported smartphones

- Android smartphones: Android 5.0 or later and compatible with Bluetooth 4.0 or later\*

- [iPhone/iPad: iPhone 4S or later/iPad 3rd generation or later](#)

\* As of September 2017. For the latest information, refer to the support site.

\* For the Bluetooth version, refer to the website for your smartphone.

---

---

## Related Topic

- [PlayMemories Home](#)
- [PlayMemories Mobile](#)
- [Snd to Smrtphn Func: Send to Smartphone](#)
- [Bluetooth Settings](#)

4-725-901-11(2) Copyright 2017 Sony Corporation

Digital Still Camera  
DSC-RX10M4

## Edit Device Name

---

You can change the device name for the Wi-Fi Direct or Bluetooth connection.

- 1 MENU →  (Network) → [Edit Device Name].**
- 2 Select the input box, then input the device name→[OK].**

---

### Related Topic

- [Wi-Fi Settings: WPS Push](#)
- [Wi-Fi Settings: Access Point Set.](#)
- [How to use the keyboard](#)

Digital Still Camera  
DSC-RX10M4

## Reset Network Set.

---

Resets all the network settings to default settings.

**1** MENU →  (Network) → [Reset Network Set.] → [Enter].

Digital Still Camera  
DSC-RX10M4

## Deleting multiple selected images (Delete)



You can delete multiple selected images. Once you have deleted an image, you cannot restore it. Confirm the image to be deleted beforehand.

1 MENU →  (Playback) → [Delete] → desired setting.

### Menu item details

#### Multiple Img.:

Deletes the selected images.

(1) Select the images to be deleted, then press the center of the control wheel. The  mark is displayed in the check box. To cancel the selection, press the center again to remove the  mark.

(2) To delete other images, repeat step (1).

(3) MENU → [OK].

#### All in this Folder:

Deletes all images in the selected folder.

#### All with this date:

Deletes all images in the selected date range.

#### All Other Than This Img.:

Deletes all images in the continuous shooting group except the selection.

#### All in Cont. Shoot Grp:

Deletes all images in the selected continuous shooting group.

#### Hint

- Perform [Format] to delete all images, including protected images.
- To display the desired folder or date, select the desired folder or date during playback by performing the following procedure:  
 (Image Index) button → select the bar on the left using the control wheel → select the desired folder or date using the top/bottom sides of the control wheel.
- If you select a continuous shooting group in [Multiple Img.], all the images in the group will be deleted. To select and delete particular images within the group, execute [Multiple Img.] while displaying the images within the group.

#### Note

- The protected images cannot be deleted.
- The menu items that can be selected vary according to the [View Mode] setting and the selected content.

### Related Topic

- [Deleting a displayed image](#)
- [Format](#)

Digital Still Camera  
DSC-RX10M4

## Switching between still images and movies (View Mode)

---

Sets the View Mode (image display method).

**1** MENU →  (Playback) → [View Mode] → desired setting.

### Menu item details

 **Date View:**

Displays the images by date.

 **Folder View(Still):**

Displays only still images.

 **AVCHD AVCHD View:**

Displays only AVCHD-format movies.

 **XAVC S HD View:**

Displays only XAVC S HD-format movies.

 **XAVC S 4K View:**

Displays only XAVC S 4K-format movies.

## Playing back images on the image index screen (Image Index)

---

You can display multiple images at the same time in playback mode.

- 1 Slide the W/T (zoom) lever to the W side while the image is being played back.
- 2 Select the image by pressing the top/bottom/right/left sides of the control wheel or turning the control wheel.

### To change the number of images to be displayed

MENU →  (Playback) → [Image Index] → desired setting.

#### Menu item details

9 Images/25 Images

### To return to single-image playback

Select the desired image and press the center of the control wheel.

### To display a desired image quickly

Select the bar on the left of the image index screen using the control wheel, then press the top/bottom sides of the control wheel. While the bar is being selected, you can display the calendar screen or folder selection screen by pressing the center. In addition, you can switch View Mode by selecting an icon.

---

#### Related Topic

- [Switching between still images and movies \(View Mode\)](#)

## Disp Cont Shoot Grp

Sets whether to display continuously shot images as a group.

1 MENU →  (Playback) → [Disp Cont Shoot Grp] → desired setting.

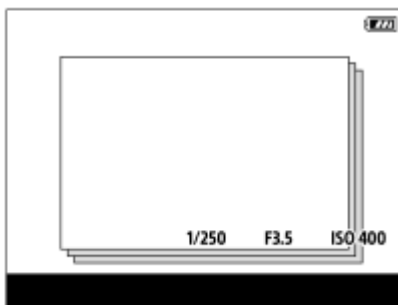

### Menu item details

#### On :

Displays continuously shot images as a group.

#### Off :

Does not display continuously shot images as a group.

#### Hint

- Images shot with [Drive Mode] set to [Cont. Shooting] are grouped. One sequence of images shot continuously by holding down the shutter button during continuous shooting becomes one group.
- On the image index screen,  is displayed over the continuous shooting group.

#### Note

- Images can be grouped and displayed only when [View Mode] is set to [Date View]. When it is not set to [Date View], images cannot be grouped and displayed, even if [Disp Cont Shoot Grp] is set to [On].
- If you delete the continuous shooting group, all the images in the group will be deleted.

### Related Topic

- [Cont. Shooting](#)



Digital Still Camera  
DSC-RX10M4

## Rotating recorded images automatically (Display Rotation)

---

Selects the orientation when playing back recorded images.

1 MENU →  (Playback) → [Display Rotation] → desired setting.

### Menu item details

**Auto:**

When you rotate the camera, the displayed image rotates automatically by detecting the orientation of the camera.

**Manual:**

Images shot vertically are displayed vertically. If you have set the image orientation using the [Rotate] function, the image will be displayed accordingly.

**Off:**

Images are always displayed horizontally.

---

### Related Topic

- [Rotating an image \(Rotate\)](#)

## Playing back images using slideshow (Slide Show)

---

Automatically plays back images continuously.

- 1 MENU →  (Playback) → [Slide Show] → desired setting.
- 2 Select [Enter].

### Menu item details

#### Repeat:

Select [On], in which images are played back in a continuous loop, or [Off], in which the product exits the slideshow when all the images are played back once.

#### Interval:

Select the display interval for images from among [1 Sec], [3 Sec], [5 Sec], [10 Sec] or [30 Sec].

### To quit the slideshow in the middle of playback

Press the MENU button to quit the slideshow. You cannot pause the slideshow.

#### Hint

- During playback, you can display the next/previous image by pressing the right/left side of the control wheel.
- You can activate a slideshow only when [View Mode] is set to [Date View] or [Folder View(Still)].

Digital Still Camera  
DSC-RX10M4

## Rotating an image (Rotate)

---

Rotates a recorded still image counter-clockwise.

**1** Display the image to be rotated, then select **MENU** →  (Playback) → **[Rotate]**.

**2** Press the center of the control wheel.

The image is rotated counter-clockwise. The image rotates as you press the center.

If you rotate the image once, the image remains rotated even after the product is turned off.

### Note



- You cannot rotate the movies.
- You may not be able to rotate images shot using other products.
- When viewing rotated images on a computer, the images may be displayed in their original orientation depending on the software.

## Enlarging an image being played back (Enlarge Image)

Enlarges the image being played back. Use this function to check the focus of the image, etc.

- 1 Display the image you want to enlarge, and slide the W/T (zoom) lever to the T side.**
  - Slide the W/T (zoom) lever to the W side to adjust the zoom scale.
  - By rotating the control dial, you can switch to the previous or next image while keeping the same zoom scale.
  - The view will zoom in on the part of the image where the camera focused during shooting. If the focus location information cannot be obtained, the camera will zoom in on the center of the image.
- 2 Select the portion you want to enlarge by pressing the top/bottom/right/left sides of the control wheel.**
- 3 Press the MENU button or the center of the control wheel to exit the playback zoom.**

### Hint

- You can also enlarge an image being played back using MENU.
- You can change the initial magnification and initial position of enlarged images by selecting MENU →  (Playback) → [ Enlarge Init. Mag.] or [ Enlarge Initial Pos.].
- You can also enlarge an image by double-tapping the monitor. In addition, you can drag and move the magnified position on the monitor. Set [Touch Operation] to other than [Off] beforehand.

### Note

- You cannot enlarge movies.

### Related Topic

- [Touch Operation](#)
- [Enlarge Init. Mag.](#)
- [Enlarge Initial Pos.](#)

Digital Still Camera  
DSC-RX10M4

## Enlarge Init. Mag.

---

Sets the initial magnification scale when playing back enlarged images.

1 MENU →  (Playback) → [ Enlarge Init. Mag.] → **desired setting.**

### Menu item details

#### Standard. Mag.:

Displays an image with the standard magnification.

#### Previous Mag.:

Displays an image with the previous magnification. The previous magnification is stored even after exiting the playback zoom mode.

---

### Related Topic

- [Enlarging an image being played back \(Enlarge Image\)](#)
- [Enlarge Initial Pos.](#)

Digital Still Camera  
DSC-RX10M4

## Enlarge Initial Pos.

---

Sets the initial position when enlarging an image in playback.

**1** MENU →  (Playback) → [ Enlarge Initial Pos.] → desired setting.

### Menu item details

**Focused Position:**

Enlarges the image from the point of focus during shooting.

**Center:**

Enlarges the image from the center of the screen.

---

### Related Topic

- [Enlarging an image being played back \(Enlarge Image\)](#)
- [Enlarge Init. Mag.](#)

Digital Still Camera  
DSC-RX10M4

## Protecting images (Protect)



Protects recorded images against accidental erasure. The  mark is displayed on protected images.

1 MENU →  (Playback) → [Protect] → desired setting.

### Menu item details

#### Multiple Img.:

Applies or cancels the protection of the selected multiple images.

(1) Select the image to be protected, then press the center of the control wheel. The  mark is displayed in the check box. To cancel the selection, press the center again to remove the  mark.

(2) To protect other images, repeat step (1).

(3) MENU → [OK].

#### All in this Folder:

Protects all images in the selected folder.

#### All with this date:

Protects all images in the selected date range.

#### Cancel All in this Folder:

Cancels the protection of all images in the selected folder.

#### Cancel All with this date:

Cancels the protection of all images in the selected date range.

#### All in Cont. Shoot Grp:

Protects all the images in the selected continuous shooting group.

#### Cancel All in Cnt Sht Grp:

Cancels the protection of all the images in the selected continuous shooting group.

#### Hint

- If you select a continuous shooting group in [Multiple Img.], all the images in the group will be protected. To select and protect particular images within the group, execute [Multiple Img.] while displaying the images within the group.

#### Note

- The menu items that can be selected vary according to the [View Mode] setting and the selected content.

Digital Still Camera  
DSC-RX10M4

## Motion Interval ADJ

---

You can adjust the interval of the tracking of the subject's motion.

**1** MENU →  (Playback) → [Motion Interval ADJ] → **desired setting.**

---

### Related Topic

- [Motion Shot Video](#)



## Specifying images to be printed (Specify Printing)



You can specify in advance on the memory card which still images you want to print out later. The **DPOF** (print order) icon will appear on the specified images. DPOF refers to “Digital Print Order Format.” DPOF setting will be retained after the image is printed. We recommend that you cancel this setting after printing.

1 MENU →  (Playback) → [Specify Printing] → desired setting.

### Menu item details

#### Multiple Img.:

Selects images to order printing.

(1) Select an image and press the center of the control wheel. The  mark is displayed in the check box. To cancel the selection, press the center again and delete the  mark.

(2) Repeat step (1) to print other images. To select all the images from a certain date or in a certain folder, select the check box for the date or folder.

(3) MENU → [OK].

#### Cancel All:

Clears all DPOF marks.

#### Print Setting:

Sets whether to print the date on images registered with DPOF marks.

- The position or size of the date (inside or outside of the image) may differ depending on the printer.

#### Note



- You cannot add the DPOF mark to the following files:
  - RAW images
- The number of copies cannot be specified.
- Some printers do not support the date print function.

Digital Still Camera  
DSC-RX10M4

## Photo Capture

---

Captures a chosen scene in a movie to save as a still image. First shoot a movie, then pause the movie during playback to capture decisive moments that tend to be missed when shooting still images, and save them as still images.

- 1 **Display the movie that you want to capture as a still image.**
  - 2 **MENU** →  (Playback) → [Photo Capture].
  - 3 **Play back the movie and pause it.**
  - 4 **Find the desired scene using forward slow playback, reverse slow playback, displays the next frame, and displays the previous frame, and then stop the movie.**
  - 5 **Press  (Photo Capture) to capture the chosen scene.**  
The scene is saved as a still image.
- 

### Related Topic

- [Shooting movies](#)
- [Playing back movies](#)

Digital Still Camera  
DSC-RX10M4

## Monitor Brightness

---

Adjust the brightness of the screen.

1 MENU →  (Setup) → [Monitor Brightness] → desired setting.

### Menu item details



#### Manual:

Adjusts the brightness within the range of -2 to +2.

#### Sunny Weather:

Sets the brightness appropriately for shooting outdoors.

#### Note

- The [Sunny Weather] setting is too bright for shooting indoors. Set [Monitor Brightness] to [Manual] for indoor shooting.
- The monitor brightness cannot be adjusted in the following situations. The maximum brightness will be [±0].
  - When [  File Format] is set to [XAVC S 4K].
  - When [  File Format] is set to [XAVC S HD] and [  Record Setting] is set to [120p]/[100p].
  - During High Frame Rate shooting
- The monitor brightness is locked at [-2] when shooting a movie using the Wi-Fi functions.

Digital Still Camera  
DSC-RX10M4

## Viewfinder Bright.

When using an electronic viewfinder, this product adjusts the brightness of the electronic viewfinder according to the surrounding environment.

1 MENU →  (Setup) → [Viewfinder Bright.] → desired setting.

### Menu item details



#### Auto:

Adjusts the brightness automatically.

#### Manual:

Selects the brightness of the electronic viewfinder within the range of -2 to +2.

#### Note

- The electronic viewfinder brightness cannot be adjusted in the following situations. The maximum brightness will be [±0].
  - When [  File Format] is set to [XAVC S 4K].
  - When [  File Format] is set to [XAVC S HD] and [  Record Setting] is set to [120p]/[100p].
  - During High Frame Rate shooting

Digital Still Camera  
DSC-RX10M4

## Finder Color Temp.

---

Adjusts the color temperature of the electronic viewfinder.

**1** MENU →  (Setup) → [Finder Color Temp.] → desired setting.

### Menu item details

#### **-2 to +2:**

When you select “-,” the viewfinder screen changes to a warmer color, and when you select “+,” it changes to a colder color.

Digital Still Camera  
DSC-RX10M4

## Gamma Disp. Assist

Movies with S-Log gamma are assumed to be processed after shooting in order to make use of the wide dynamic range. They are therefore displayed in low contrast during shooting and may be difficult to monitor, using [Gamma Disp. Assist], contrast equivalent to that of normal gamma can be reproduced. In addition, [Gamma Disp. Assist] can also be applied when playing back movies on the camera's monitor/viewfinder.

- 1 MENU →  (Setup) → [Gamma Disp. Assist].
- 2 Select the desired setting using the top/bottom sides of the control wheel.

### Menu item details

Assist  
OFF **Off:**

Does not apply [Gamma Disp. Assist].

Assist  
AUTO **Auto:**

Displays movies with an [S-Log2→709(800%)] effect when the gamma set in [Picture Profile] is [S-Log2], and with an [S-Log3→709(800%)] effect when the gamma is set to [S-Log3].

Assist  
S-Log2 **S-Log2→709(800%):**

Displays movies with an S-Log2 gamma reproducing contrast equivalent to ITU709 (800%).

Assist  
S-Log3 **S-Log3→709(800%):**

Displays movies with an S-Log3 gamma reproducing contrast equivalent to ITU709 (800%).

#### Note

- When [Gamma Disp. Assist] is set to [Auto] during playback, the picture is displayed based on the current gamma setting in [Picture Profile] instead of auto-detecting the gamma value of the movie.
- [Gamma Disp. Assist] is not applied to movies when displayed on a TV or monitor connected to the camera.

### Related Topic

- [Picture Profile](#)

Digital Still Camera  
DSC-RX10M4

## Volume Settings

---

Sets the sound volume for movie playback.

**1** MENU →  (Setup) → [Volume Settings] → desired setting.

### Adjusting the volume during playback

Press the bottom side of the control wheel while playing back movies to display the operation panel, then adjust the volume. You can adjust the volume while listening to the actual sound.

Digital Still Camera  
DSC-RX10M4

## Tile Menu

---

Selects whether to always display the first screen of the menu when you press the MENU button.

**1** MENU →  (Setup) → [Tile Menu] → desired setting.

### Menu item details

**On:**

Always displays the first screen of the menu (Tile Menu).

**Off:**

Deactivates the Tile Menu display.



Digital Still Camera  
DSC-RX10M4

## Mode Dial Guide

---

You can display the description of a shooting mode when you turn the mode dial and change the settings available for that shooting mode.

**1** MENU →  (Setup) → [Mode Dial Guide] → desired setting.

### Menu item details

**On:**

Displays the Mode Dial Guide.

**Off:**

Does not display the Mode Dial Guide.

Digital Still Camera  
DSC-RX10M4

## Delete confirm.

---

You can set whether [Delete] or [Cancel] is selected as a default on the delete confirmation screen.

**1** MENU →  (Setup) → [Delete confirm.] → desired setting.

### Menu item details

**"Delete" first:**

[Delete] is selected as the default setting.

**"Cancel" first:**

[Cancel] is selected as the default setting.

Digital Still Camera  
DSC-RX10M4

## Display Quality

---

You can change the display quality.

**1** MENU →  (Setup) → [Display Quality] → desired setting.

### Menu item details

**High:**

Displays in high quality.

**Standard:**

Displays in standard quality.

**Note**

- When [High] is set, battery consumption will be higher than when [Standard] is set.

Digital Still Camera  
DSC-RX10M4

## Pwr Save Start Time

---

Sets time intervals to automatically switch to power save mode when you are not performing operations to prevent wearing down the battery pack. To return to shooting mode, perform an operation such as pressing the shutter button halfway down.

1 MENU →  (Setup) → [Pwr Save Start Time] → desired setting.

### Menu item details

30 Min/5 Min/2 Min/1 Min/10 Sec

#### Note

- Turn off the product when you do not use it for a long time.
- The power save function is not activated when power is being supplied via USB, when playing back slideshows, when recording movies, or when connected to a computer or TV.

Digital Still Camera  
DSC-RX10M4

## NTSC/PAL Selector

---

Plays back movies recorded with the product on a NTSC/PAL system TV.

**1** MENU →  (Setup) → [NTSC/PAL Selector] → [Enter]

### Note

- If you insert a memory card that has previously been formatted with a different video system, a message telling you that you must reformat the card will appear.  
If you want to record using another system, re-format the memory card or use another memory card.
- When you perform [NTSC/PAL Selector], and the setting is changed from the default one, a message "Running on NTSC." or "Running on PAL." will appear on the start-up screen.

Digital Still Camera  
DSC-RX10M4

## Touch Operation

---

Sets whether or not to activate touch operations on the monitor.

Touch operations when shooting with the monitor are referred to as "touch panel operations," and touch operations when shooting with the viewfinder are referred to as "touch pad operations."

1 MENU →  (Setup) → [Touch Operation] → desired setting.

### Menu item details

#### Touch Panel+Pad:

Activates both the touch panel operations when shooting with the monitor and touch pad operations when shooting with the viewfinder.

#### Touch Panel Only:

Activates only the touch panel operations when shooting with the monitor.

#### Touch Pad Only:

Activates only the touch pad operations when shooting with the viewfinder.

#### Off:

Deactivates all touch operations.

---

### Related Topic

- [Touch Focus](#)
- [Touch Pad Settings](#)

Digital Still Camera  
DSC-RX10M4

## Touch Pad Settings

You can adjust settings related to touch pad operations during viewfinder shooting.

1 MENU →  (Setup) → [Touch Pad Settings] → desired setting.

### Menu item details

#### Operation in V Orient.:

Sets whether to enable touch pad operations during vertically oriented viewfinder shooting. You can prevent erroneous operations during vertically oriented shooting caused by your nose, etc. touching the monitor.

#### Touch Pos. Mode:

Sets whether to move the focusing frame to the position touched on the screen ([Absolute Position]), or move the focusing frame to the desired position based on the direction of dragging and the amount of movement ([Relative Position]).

#### Operation Area:

Sets the area to be used for touch pad operations. Restricting the operational area can prevent erroneous operations caused by your nose, etc. touching the monitor.

### About Touch Positioning Mode

Selecting [Absolute Position] lets you move the focusing frame to a distant position more quickly because you can directly specify the position of the focusing frame with touch operations.

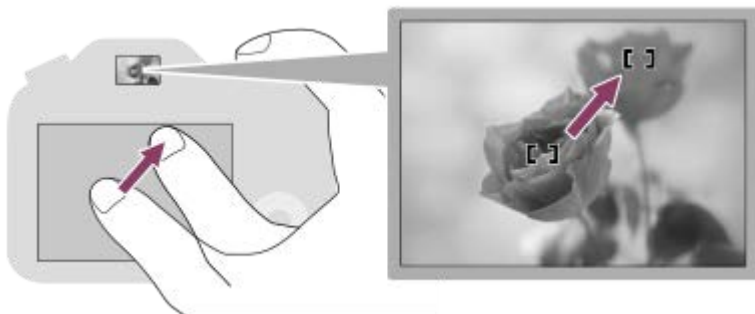

Selecting [Relative Position] lets you operate the touch pad from wherever is easiest, without having to move your finger over a wide area.

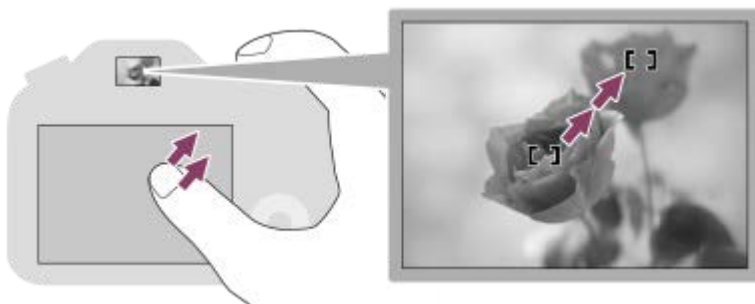

#### Hint

- In touch pad operations when [Touch Pos. Mode] is set to [Absolute Position], the area set in [Operation Area] is treated as the entire screen.

---

---

## Related Topic

- [Touch Operation](#)

4-725-901-11(2) Copyright 2017 Sony Corporation



Digital Still Camera  
DSC-RX10M4

## Demo Mode

---

The [Demo Mode] function displays the movies recorded on the memory card automatically (demonstration), when the camera has not been operated for a certain time. Normally select [Off].

1 MENU →  (Setup) → [Demo Mode] → desired setting.

### Menu item details

#### On:

The movie playback demonstration starts automatically if the product is not operated for about one minute. Only protected AVCHD movies can be played back.

Set the view mode to [AVCHD View], and protect the movie file with the oldest recorded date and time.

#### Off:

Does not show the demonstration.

#### Note

- You can set this item only when the product is powered by the AC Adaptor (supplied).
- When there is no protected AVCHD movies on the memory card, you cannot select [On].

Digital Still Camera  
DSC-RX10M4

## TC/UB Settings

The time code (TC) and the user bit (UB) information can be recorded as data attached to movies.

- 1 MENU →  (Setup) → [TC/UB Settings] → setting value you want to change.

### Menu item details

#### TC/UB Disp. Setting:

Sets the display for the counter, time code, and user bit.

#### TC Preset:

Sets the time code.

#### UB Preset:

Sets the user bit.

#### TC Format:

Sets the recording method for the time code. (Only when [NTSC/PAL Selector] is set to NTSC.)

#### TC Run:

Sets the count up format for the time code.

#### TC Make:

Sets the recording format for the time code on the recording medium.



#### UB Time Rec:

Sets whether or not to record the time as a user bit.

### How to set the time code (TC Preset)

1. MENU →  (Setup) → [TC/UB Settings] → [TC Preset].
2. Turn the control wheel and select the first two digits.
  - The time code can be set between the following range.  
When [60i] is selected: 00:00:00:00 to 23:59:59:29
  - \* When [24p] is selected, you can select the last two digits of the time code in multiples of four from 0 to 23 frames.  
When [50i] is selected: 00:00:00:00 to 23:59:59:24
3. Set the other digits following the same procedure as in step 2, then press in the center of the control wheel.



### How to reset the time code

1. MENU →  (Setup) → [TC/UB Settings] → [TC Preset].
  2. Press the  (Delete) button to reset the time code (00:00:00:00).
- You can also reset the time code (00:00:00:00) using the RMT-VP1K remote commander (sold separately).

### How to set the user bit (UB Preset)

1. MENU →  (Setup) → [TC/UB Settings] → [UB Preset].
2. Turn the control wheel and select the first two digits.
3. Set the other digits following the same procedure as in step 2, then press in the center of the control wheel.

### How to reset the user bit

1. MENU →  (Setup) → [TC/UB Settings] → [UB Preset].
2. Press the  (Delete) button to reset the user bit (00 00 00 00).

### How to select the recording method for the time code (TC Format<sup>\*1</sup>)

1. MENU →  (Setup) → [TC/UB Settings] → [TC Format].

**DF:**

Records the time code in Drop Frame<sup>\*2</sup> format.

**NDF:**

Records the time code in Non-Drop Frame format.

\*1 Only when [NTSC/PAL Selector] is set to NTSC.

\*2 The time code is based on 30 frames per second. However, a gap between the actual time and the time code will occur during extended periods of recording as the frame frequency of the NTSC image signal is approximately 29.97 frames per second. Drop frame corrects this gap to make the time code and actual time equal. In drop frame, the first 2 frame numbers are removed every minute except for every tenth minute. The time code without this correction is called non-drop frame.

- The setting is fixed to [NDF] when recording in 4K/24p or 1080/24p.

**How to select the count up format for the time code (TC Run)**

1. MENU →  (Setup) → [TC/UB Settings] → [TC Run].

**Rec Run:**

Sets the stepping mode for the time code to advance only while recording. The time code is recorded sequentially from the last time code of the previous recording.

**Free Run:**

Sets the stepping mode for the time code to advance anytime, regardless of the camera operation.

- The time code may not be recorded sequentially in the following situations even when the time code advances in [Rec Run] mode.
  - When the recording format is changed.
  - When the recording medium is removed.

**How to select how the time code is recorded (TC Make)**

1. MENU →  (Setup) → [TC/UB Settings] → [TC Make].

**Preset:**

Records the newly set time code on the recording medium.

**Regenerate:**

Reads the last time code for the previous recording from the recording medium and records the new time code consecutively from the last time code. The time code advances in [Rec Run] mode regardless of the [TC Run] setting.

Digital Still Camera  
DSC-RX10M4

## HDMI Settings: HDMI Resolution

When you connect the product to a High Definition (HD) TV with HDMI terminals using an HDMI cable (sold separately), you can select HDMI Resolution to output images to the TV.

1 MENU →  (Setup) → [HDMI Settings] → [HDMI Resolution] → desired setting.

### Menu item details

**Auto:**

The product automatically recognizes an HD TV and sets the output resolution.

**2160p/1080p:**

Outputs signals in 2160p/1080p.

**1080p:**

Outputs signals in HD picture quality (1080p).

**1080i:**

Outputs signals in HD picture quality (1080i).

**Note**

- If the images are not displayed properly using the [Auto] setting, select either [1080i], [1080p] or [2160p/1080p], based on which TV is to be connected.

## HDMI Settings: 24p/60p Output (movie) (Only for 1080 60i compatible models)

You can set 1080/24p or 1080/60p as the HDMI output format when [ Record Setting] is set to [24p 50M].

1 MENU →  (Setup) → [HDMI Settings] → [HDMI Resolution] → [1080p] or [2160p/1080p].

2 MENU →  (Setup) → [HDMI Settings] → [ 24p/60p Output] → desired setting.

### Menu item details

#### 60p:

Movies are output as 60p.

#### 24p:

Movies are output as 24p.

#### Note

- Steps 1 and 2 can be set in either order.
- When [ Record Setting] is set to other than [24p 50M], this setting is canceled, and HDMI video is output according to the [HDMI Resolution] settings.

### Related Topic

- [Record Setting \(movie\)](#)

Digital Still Camera  
DSC-RX10M4

## HDMI Settings: HDMI Info. Display

---

Selects whether to display the shooting information when this product and the TV are connected using an HDMI cable (sold separately).

1 MENU →  (Setup) → [HDMI Settings] → [HDMI Info. Display] → desired setting.

### Menu item details

#### On:

Displays the shooting information on the TV.

The recorded image and the shooting information are displayed on the TV, while nothing is displayed on the camera's monitor.

#### Off:

Does not display the shooting information on the TV.

Only the recorded image is displayed on the TV, while the recorded image and the shooting information are displayed on the camera's monitor.

#### Note

- When this product is connected to a 4K-compatible TV, [Off] is selected automatically.
- If you set [ File Format] to [XAVC S 4K] and shoot movies while the camera is connected to an HDMI device, images will not be displayed on the monitor.

Digital Still Camera  
DSC-RX10M4

## HDMI Settings: TC Output (movie)

Sets whether or not to layer the TC (time code) information on the output signal via the HDMI terminal when outputting the signal to other professional-use devices.

This function layers the time code information on the HDMI output signal. The product sends the time code information as digital data, not as an image displayed on the screen. The connected device can then refer to the digital data to recognize the time data.

1 MENU →  (Setup) → [HDMI Settings] → [ TC Output] → desired setting.

### Menu item details



#### On:

Time code is output to other devices.

#### Off:

Time code is not output to other devices.

#### Note

- When [ TC Output] is set to [On], the image may not be output properly to the TV or recording device. In such cases, set [ TC Output] to [Off].

Digital Still Camera  
DSC-RX10M4

## HDMI Settings: REC Control (movie)

If you connect the camera to an external recorder/player, you can remotely command the recorder/player to start/stop recording using the camera.

1 MENU →  (Setup) → [HDMI Settings] → [ REC Control] → desired setting.

### Menu item details

On:







 STBY The camera can send a recording command to an external recorder/player.

 REC The camera is sending a recording command to an external recorder/player.

Off:

The camera is not able to send a command to an external recorder/player to start/stop recording.

#### Note

- Available for external recorders/players compatible with [ REC Control].
- When you use the [ REC Control] function, set the shooting mode to  (Movie).
- When [ TC Output] is set to [Off], you cannot use the [ REC Control] function.
- Even when  REC is displayed, the external recorder/player may not work properly depending on the settings or status of the recorder/player. Check if the external recorder/player works properly before use.



Digital Still Camera  
DSC-RX10M4

## HDMI Settings: CTRL FOR HDMI

When connecting this product to a “BRAVIA” Sync-compatible TV using an HDMI cable (sold separately), you can operate this product by aiming the TV remote control at the TV.

1 MENU →  (Setup) → [HDMI Settings] → [CTRL FOR HDMI] → desired setting.

2 Connect this product to a “BRAVIA” Sync-compatible TV.

The input of the TV is switched automatically and images on this product are displayed on the TV screen.

3 Press the SYNC MENU button of the TV’s remote control.

4 Operate this product using the TV’s remote control.

### Menu item details

#### On:

You can operate this product with a TV’s remote control.

#### Off:

You cannot operate this product with a TV’s remote control.



#### Note

- If you connect this product to a TV using an HDMI cable, available menu items are limited.
- [CTRL FOR HDMI] is available only with a “BRAVIA” Sync-compatible TV. Also, the SYNC MENU operation differs depending on the TV you are using. For details, refer to the operating instructions supplied with the TV.
- If the product performs unwanted operations in response to the TV remote control when the product is connected to another manufacturer’s TV using an HDMI connection, select MENU →  (Setup) → [HDMI Settings] → [CTRL FOR HDMI] → [Off].

Digital Still Camera  
DSC-RX10M4

## 4K Output Sel. (movie)

You can set how to record movies and perform HDMI output when your camera is connected to 4K-compatible external recording/playback devices, etc.

- 1 Turn the mode dial to  (movie).
- 2 Connect the camera to the desired device via an HDMI cable.
- 3 MENU →  (Setup) → [ 4K Output Sel.] → desired setting.

### Menu item details

#### Memory Card+HDMI:

Simultaneously outputs to the external recording/playback device and records on the camera's memory card.

#### HDMI Only(30p):

Outputs a 4K movie in 30p to the external recording/playback device without recording on the camera's memory card.

#### HDMI Only(24p):

Outputs a 4K movie in 24p to the external recording/playback device without recording on the camera's memory card.

#### HDMI Only(25p)\*:

Outputs a 4K movie in 25p to the external recording/playback device without recording on the camera's memory card.

\* Only when [NTSC/PAL Selector] is set to PAL.

### Note

- This item can be set only when the camera is in movie mode and connected to a 4K-compatible device.
- When [HDMI Only(30p)], [HDMI Only(24p)] or [HDMI Only(25p)] is set, [HDMI Info. Display] will temporarily be set to [Off].
- When [HDMI Only(30p)], [HDMI Only(24p)] or [HDMI Only(25p)] is set, the counter does not move forward (the actual recording time is not counted) while the movie is being recorded on an external recording/playback device.
- When [ File Format] is set to [XAVC S 4K] and the camera is connected via HDMI, the following functions are not available.
  - [Smile/Face Detect.]
  - [Center Lock-on AF]

### Related Topic

- [HDMI Settings: REC Control \(movie\)](#)
- [File Format \(movie\)](#)
- [Record Setting \(movie\)](#)
- [HDMI Settings: HDMI Info. Display](#)

Digital Still Camera  
DSC-RX10M4

## USB Connection

---

Selects the USB connection method when this product is connected to a computer, etc.

1 MENU →  (Setup) → [USB Connection] → desired setting.

### Menu item details

#### Auto:

Establishes a Mass Storage or MTP connection automatically, depending on the computer or other USB devices to be connected. Windows 7, Windows 8.1, or Windows 10 computers are connected in MTP, and their unique functions are enabled for use.

#### Mass Storage:

Establishes a Mass Storage connection between this product, a computer, and other USB devices.

#### MTP:

Establishes an MTP connection between this product, a computer, and other USB devices. Windows 7, Windows 8.1, or Windows 10 computers are connected in MTP, and their unique functions are enabled for use.

#### PC Remote:

Uses “Remote Camera Control” to control this product from the computer, including such functions as shooting and storing images on the computer.

#### Note

- It may take some time to make the connection between this product and a computer when [USB Connection] is set to [Auto].

---

### Related Topic

- [PC Remote Settings: Still Img. Save Dest.](#)
- [PC Remote Settings: RAW+J PC Save Img](#)

Digital Still Camera  
DSC-RX10M4

## USB LUN Setting

---

Enhances compatibility by limiting of USB connection functions.

**1** MENU →  (Setup) → [USB LUN Setting] → desired setting.

### Menu item details

**Multi:**

Normally, use [Multi].

**Single:**

Set [USB LUN Setting] to [Single] only if you cannot make a connection.

Digital Still Camera  
DSC-RX10M4

## USB Power Supply

---

Sets whether to supply power via the micro USB cable when the product is connected to a computer or an USB device.

**1** MENU →  (Setup) → [USB Power Supply] → desired setting.

### Menu item details

**On:**

Power is supplied to the product via a micro USB cable when the product is connected to a computer, etc.

**Off:**

Power is not supplied to the product via a micro USB cable when the product is connected to a computer, etc. If you use the supplied AC Adaptor, power will be supplied even when [Off] is selected.

**Note**

- Insert the battery pack into the product to supply power via USB cable.

Digital Still Camera  
DSC-RX10M4

## PC Remote Settings: Still Img. Save Dest.

Sets whether to save still images stored in both the camera and the computer during PC Remote shooting. This setting is useful when you want to check recorded images on the camera without leaving the camera.

\* PC Remote: Uses "Remote Camera Control" to control this product from the computer, including such functions as shooting and storing images on the computer.

**1** MENU →  (Setup) → [PC Remote Settings] → [Still Img. Save Dest.] → desired setting.

### Menu item details

#### PC Only:

Saves still images only on the computer.

#### PC+Camera:

Saves still images on the computer and the camera.

#### Note

- During PC Remote shooting, you cannot change settings for [Still Img. Save Dest.]. Adjust the settings before you start shooting.
- If you insert a memory card that is not recordable, you cannot shoot still images even if you select [PC+Camera].
- If you select [PC+Camera] and you have not inserted a memory card into the camera, you cannot release the shutter even if [Release w/o Card] is set to [Enable].
- While you are playing back still images on the camera, you cannot shoot using PC Remote.

### Related Topic

- [USB Connection](#)
- [Release w/o Card](#)
- [PC Remote Settings: RAW+J PC Save Img](#)

Digital Still Camera  
DSC-RX10M4

## PC Remote Settings: RAW+J PC Save Img

Selects the file type for images to be transferred to the computer in PC Remote shooting.

When shooting still images using PC Remote, the application on the computer does not display the image until the image has been completely transferred. When performing RAW+JPEG shooting, you can accelerate the display processing speed by transferring only JPEG images instead of transferring both RAW and JPEG images.

\* PC Remote: Uses "Remote Camera Control" to control this product from the computer, including such functions as shooting and storing images on the computer.

1 MENU →  (Setup) → [PC Remote Settings] → [RAW+J PC Save Img] → desired setting.

### Menu item details

#### RAW & JPEG:

Transfers both RAW and JPEG files to the computer.

#### JPEG Only:

Transfers only JPEG files to the computer.

#### RAW Only:

Transfers only RAW files to the computer.

#### Note

- [RAW+J PC Save Img] can be set only when [ Quality] is set to [RAW & JPEG].

### Related Topic

- [USB Connection](#)
- [Quality \(still image\)](#)
- [PC Remote Settings: Still Img. Save Dest.](#)

Digital Still Camera  
DSC-RX10M4

## Language

---

Selects the language to be used in the menu items, warnings and messages.

**1** MENU →  (Setup) → [ Language] → **desired language**.



Digital Still Camera  
DSC-RX10M4

## Date/Time Setup

---

The Clock Set screen is displayed automatically when you turn on this product for the first time or when the internal rechargeable backup battery has fully discharged. Select this menu when setting the date and time after the first time.

1 MENU →  (Setup) → [Date/Time Setup] → desired setting.

### Menu item details

**Daylight Savings:**

Selects Daylight Savings [On]/[Off].

**Date/Time:**

Sets the date and time.

**Date Format:**

Selects the date and time display format.

#### Hint

- To charge the internal rechargeable backup battery, insert a charged battery pack, and leave the product for 24 hours or more with the power off.
- If the clock resets every time the battery is charged, the internal rechargeable backup battery may be worn out. Consult your service facility.

Digital Still Camera  
DSC-RX10M4

## Area Setting

---

Sets the area where you are using the product.

**1** MENU →  (Setup) → [Area Setting] → desired area.

Digital Still Camera  
DSC-RX10M4

## Copyright Info

---

Writes copyright information onto the still images.

- 1 **MENU** →  (Setup) → **[Copyright Info]** → **desired setting**.
- 2 **When you select [Set Photographer] or [Set Copyright], a keyboard appears on the screen. Enter your desired name.**

### Menu item details

#### Write Copyright Info:

Sets whether to write copyright information. ([On]/[Off])

- If you select [On], an  icon will appear on the shooting screen.

#### Set Photographer:

Sets the photographer name.

#### Set Copyright:

Sets the copyright holder name.

#### Disp. Copyright Info:

Displays the current copyright information.

#### Note

- You can only enter alphanumeric characters and symbols for [Set Photographer] and [Set Copyright]. You can enter up to 46 letters.
- A  icon appears during the playback of images with copyright information.
- In order to prevent unauthorized use of [Copyright Info], be sure to clear the [Set Photographer] and [Set Copyright] columns before lending out or handing over your camera.
- Sony is not liable for problems or damages resulting from use of [Copyright Info].

---

### Related Topic

- [How to use the keyboard](#)

Digital Still Camera  
DSC-RX10M4

## Format

---

When you use a memory card with this camera for the first time, we recommend that you format the card using the camera for stable performance of the memory card. Note that formatting permanently erases all data on the memory card, and is unrecoverable. Save valuable data on a computer, etc.

1 MENU →  (Setup) → [Format].

### Note

- Formatting permanently erases all data including protected images and registered settings (from M1 to M4).
- The access lamp lights up during formatting. Do not remove the memory card while the access lamp is lit up.
- Format the memory card on this camera. If you format the memory card on the computer, the memory card may not be usable depending on the format type.
- It may take a few minutes to complete formatting, depending on the memory card.
- You cannot format the memory card if the remaining battery charge is less than 1%.

Digital Still Camera  
DSC-RX10M4

## File Number

---

Selects how to assign file numbers to still images.

**1** MENU →  (Setup) → [File Number] → desired setting.

### Menu item details

**Series :**

The product will assign numbers to files sequentially up to "9999" without resetting.

**Reset :**

The product resets numbers when a file is recorded in a new folder and assigns numbers to files starting with "0001".

(When the recording folder contains a file, a number one higher than the largest number is assigned.)

Digital Still Camera  
DSC-RX10M4

## Set File Name

---

You can specify the first three characters of the file name for images you shoot.

- 1 MENU →  (Setup) → [Set File Name].
- 2 Select the entry field for the file name to display a keyboard on the screen, and then enter three characters of your choice.

### Note

- Only capital letters, numbers, and underscores can be entered. However, an underscore cannot be used as the first character.
- The three characters of the file name you specify using [Set File Name] will only be applied to images you shoot after changing the setting.

---

### Related Topic

- [How to use the keyboard](#)

Digital Still Camera  
DSC-RX10M4

## Select REC Folder

---

If [Folder Name] is set to [Standard Form] and there are 2 folders or more, you can select the folder on the memory card to which images are to be recorded.

1 MENU →  (Setup) → [Select REC Folder] → desired folder.

### Note

- You cannot select the folder when [Folder Name] is set to [Date Form].

---

### Related Topic

- [Folder Name](#)

Digital Still Camera  
DSC-RX10M4

## New Folder

---

Creates a new folder on the memory card for recording still images. A new folder is created with a folder number one greater than the largest folder number currently used. Images are recorded in the newly created folder.

1 MENU →  (Setup) → [New Folder].

### Note

- When you insert a memory card that was used with other equipment into this product and shoot images, a new folder may be automatically created.
- Up to 4,000 images in total can be stored in one folder. When the folder capacity is exceeded, a new folder may be automatically created.



Digital Still Camera  
DSC-RX10M4

## Folder Name

---

Still images are recorded in a folder that is automatically created inside the DCIM folder on the memory card. You can change the way folder names are assigned.

1 MENU →  (Setup) → [Folder Name] → desired setting.

### Menu item details

#### Standard Form:

The folder name form is as follows: folder number + MSDCF.

Example: 100MSDCF

#### Date Form:

The folder name form is as follows: folder number + Y (the last digit)/MM/DD.

Example: 10070405 (Folder number: 100, date: 04/05/2017)

#### Note

- You cannot change the [Folder Name] settings for movies.

Digital Still Camera  
DSC-RX10M4

## Recover Image DB

---

If image files were processed on a computer, problems may occur in the image database file. In such cases, the images on the memory card will not be played back on this product. If these problems happen, repair the file using [Recover Image DB].

1 MENU →  (Setup) → [Recover Image DB] → [Enter].

### Note

- Use a sufficiently charged battery pack. Low battery power during repairing can cause damage to data.

Digital Still Camera  
DSC-RX10M4

## Display Media Info.

---

Displays the recordable time of movies for the inserted memory card. Also displays the number of recordable still images for the inserted memory card.

**1** MENU →  (Setup) → [Display Media Info.].

Digital Still Camera  
DSC-RX10M4

## Version

---

Displays the version of this product's software. Check the version when updates for this product's software are released, etc.

1 MENU →  (Setup) → [Version].

### Note

- Updating can be performed only when the battery level is  (3 remaining battery bars) or more. The use of a sufficiently charged battery or the AC Adaptor (sold separately) is recommended.

Digital Still Camera  
DSC-RX10M4

## Setting Reset

---

Resets the product to the default settings. Even if you perform [Setting Reset], the recorded images are retained.

1 MENU →  (Setup) → [Setting Reset] → desired setting.

### Menu item details

#### Camera Settings Reset:

Initializes the main shooting settings to the default settings.

#### Initialize:

Initializes all the settings to the default settings.

#### Note

- Be sure not to eject the battery pack while resetting.
- Settings of [Picture Profile] will not be reset even when [Camera Settings Reset] or [Initialize] is performed.

Digital Still Camera  
DSC-RX10M4

## Add Item

---

You can register the desired menu items to ★ (My Menu) under MENU.

- 1 MENU → ★ (My Menu) → [Add Item].
- 2 Select an item that you want to add to ★ (My Menu) using the top/bottom/left/right sides of the control wheel.
- 3 Select a destination using the top/bottom/left/right sides of the control wheel.

### Hint

- You can add up to 30 items to ★ (My Menu).

### Note

- You cannot add the following items to ★ (My Menu).
  - Any item under MENU →  (Playback)
  - [View on TV]

---

### Related Topic

- [Sort Item](#)
- [Delete Item](#)
- [Using MENU items](#)

Digital Still Camera  
DSC-RX10M4

## Sort Item

---

You can rearrange the menu items added to ★ (My Menu) under MENU.

- 1 MENU → ★ (My Menu) → [Sort Item].
  - 2 Select an item that you want to move using the top/bottom/left/right sides of the control wheel.
  - 3 Select a destination using the top/bottom/left/right sides of the control wheel.
- 

### Related Topic

- [Add Item](#)

Digital Still Camera  
DSC-RX10M4

## Delete Item

---

You can delete menu items added to ★ (My Menu) of MENU.

1 MENU → ★ (My Menu) → [Delete Item].

2 Select an item that you want to delete using the top/bottom/left/right sides of the control wheel, and then press the center to delete the selected item.

### Hint

- To delete all the items on a page, select MENU → ★ (My Menu) → [Delete Page].
- You can delete all the items added to ★ (My Menu) by selecting MENU → ★ (My Menu) → [Delete All].

---

### Related Topic

- [Delete Page](#)
- [Delete All](#)
- [Add Item](#)



Digital Still Camera  
DSC-RX10M4

## Delete Page

---

You can delete all the menu items added to a page under ★ (My Menu) in MENU.

- 1 MENU → ★ (My Menu) → [Delete Page].
  - 2 Select a page that you want to delete using the left/right sides of the control wheel, and then press the center of the control wheel to delete the items.
- 

### Related Topic

- [Add Item](#)
- [Delete All](#)

Digital Still Camera  
DSC-RX10M4

## Delete All

---

You can delete all the menu items added to ★ (My Menu) in MENU.

- 1 MENU → ★ (My Menu) → [Delete All].
  - 2 Select [OK].
- 

### Related Topic

- [Add Item](#)
- [Delete Page](#)

Digital Still Camera  
DSC-RX10M4

## Precautions

---

Refer also to “Notes on using your camera” in the Instruction Manual (supplied) for this product.

### Backing up memory cards

Data may be corrupted in the following cases. Be sure to back up the data for protection.

- When the memory card is removed, the USB cable is disconnected, or the product is turned off in the middle of a read or write operation.
- When the memory card is used in locations subject to static electricity or electrical noise.

### Database file error

If you insert a memory card that does not contain an image database file into the product and turn on the power, the product automatically creates an image database file using some of the memory card's capacity. The process may take a long time and you cannot operate the product until the process is completed.

If a database file error occurs, export all images to your computer using PlayMemories Home, and then format the memory card using this product.

### Do not use/store the product in the following places

- In an extremely hot, cold or humid place  
In places such as in a car parked in the sun, the camera body may become deformed and this may cause a malfunction.
- Storing under direct sunlight or near a heater  
The camera body may become discolored or deformed, and this may cause a malfunction.
- In a location subject to rocking vibration
- Near strong magnetic place
- In sandy or dusty places  
Be careful not to let sand or dust get into the product. This may cause the product to malfunction, and in some cases this malfunction cannot be repaired.
- In places with high humidity  
This may cause the lens to mold.

### On storing

If the camera is dirty after use, clean it. Water, sand, dust, salt, etc. left in the camera may cause a malfunction.

### Precaution on carrying

- Do not carry the camera with the tripod attached. This may cause the tripod socket hole to break.
- Do not apply excessive force to the camera, such as by holding the monitor or flash part, hitting the lens part, etc.

### On operating temperatures

Shooting in extremely cold or hot places that exceed this range is not recommended.

### On moisture condensation

- If the product is brought directly from a cold to a warm location, moisture may condense inside or outside the product. This moisture condensation may cause a malfunction of the product.
- To prevent moisture condensation when you bring the product directly from a cold to a warm location, first put it in a plastic bag and seal it to prevent air from entering. Wait for about an hour until the temperature of the product has

reached the ambient temperature.

- If moisture condensation occurs, turn off the product and wait about an hour for the moisture to evaporate. Note that if you attempt to shoot with moisture remaining inside the lens, you will be unable to record clear images.

## **On image data compatibility**

This product conforms with DCF (Design rule for Camera File system) universal standard established by JEITA (Japan Electronics and Information Technology Industries Association).

## **Notes on playing movies on other devices**

XAVC S movies can be played back only on XAVC S-supported devices.

## **On the monitor and viewfinder**

- If you use the camera in a cold location, the image may have a trailing appearance. This is not a malfunction.
- Do not press against the monitor. The monitor may be discolored and that may cause a malfunction.
- If the monitor has drops of water or other liquids on it, wipe it with a soft cloth. If the monitor stays wet, the surface of the monitor may change or deteriorate. This may cause a malfunction.
- If the subject is too close, the image may show any dust or fingerprints on the lens. Wipe the lens with a soft cloth, etc.
- The camera uses magnetic parts including magnets. Do not bring objects affected by magnetism, including credit cards and floppy disks, close to the camera.

Digital Still Camera  
DSC-RX10M4

## On cleaning

---

### Cleaning the lens, finder and flash

Wipe the lens, finder and flash with a soft cloth to remove fingerprints, dust, etc.

### Cleaning the lens

- Do not use a cleaning solution containing organic solvents, such as thinner, or benzine.
- When cleaning the lens surface, remove dust with a commercially available blower. In case of dust that sticks to the surface, wipe it off with a soft cloth or tissue paper slightly moistened with lens cleaning solution. Wipe in a spiral pattern from the center to the outside. Do not spray lens cleaning solution directly onto the lens surface.

### Cleaning the product surface

Clean the product surface with a soft cloth slightly moistened with water, then wipe the surface with a dry cloth. To prevent damage to the finish or casing:

- Do not expose the product to chemical products such as thinner, benzine, alcohol, disposable cloths, insect repellent, sunscreen or insecticide.
- Do not touch the product with any of the above on your hand.
- Do not leave the product in contact with rubber or vinyl for a long time.

### Cleaning the monitor

- If you wipe the monitor firmly using tissue paper, etc., the coating may be scratched.
- If the monitor becomes dirty with fingerprints or dust, gently remove the dust from the surface, and then clean the monitor using soft cloth, etc.

Digital Still Camera  
DSC-RX10M4

## Number of recordable images

When you insert a memory card into the camera and set the ON/OFF (Power) switch to "ON," the number of images that can be recorded (should you continue to shoot using the current settings) is displayed on the screen.

### Note

- When "0" (the number of recordable images) flashes in orange, the memory card is full. Replace the memory card with another one, or delete images from the current memory card.
- When "NO CARD" flashes in orange, it means no memory card has been inserted. Insert a memory card.

### The number of images that can be recorded on a memory card

The table below shows the approximate number of images that can be recorded on a memory card formatted with this camera. The values are defined using Sony standard memory cards for testing.

The values may vary depending on the shooting conditions and the type of memory card used.

[ Image Size]: [L: 20M]

[ Aspect Ratio] is set to [3:2]\*

(Units: Images)

 Quality	8 GB	32 GB	64 GB	256 GB
Standard	1150	4800	9600	37500
Fine	690	2800	5500	22000
Extra fine	510	2050	4150	16000
RAW & JPEG	235	950	1900	7500
RAW	355	1400	2850	11000

\* When [ Aspect Ratio] is set to other than [3:2], you can record more images than the numbers shown in the table above. (except when [RAW] is selected)



### Note

- Even if the number of recordable images is higher than 9999 images, "9999" will appear.
- When an image shot with another product is played back on this camera, the image may not appear in its actual size.
- The numbers shown are when using a Sony memory card.

Digital Still Camera  
DSC-RX10M4

## Recordable movie times

The table below shows the approximate total recording times using a memory card formatted with this camera. The values may vary depending on the shooting conditions and the type of memory card used.

The recording times for when [  File Format ] is set to [XAVC S 4K] and [XAVC S HD] are recording times when shooting with [  Proxy Recording ] set to [Off].

(h (hour), m (minute))

	8 GB	32 GB	64 GB	256 GB
XAVC S 4K 30p 100M/25p 100M	9 m	35 m	1 h 15 m	5 h 15 m
XAVC S 4K 30p 60M/25p 60M	10 m	1 h	2 h 5 m	8 h 35 m
XAVC S 4K 24p 100M*/–	9 m	35 m	1 h 15 m	5 h 15 m
XAVC S 4K 24p 60M*/–	10 m	1 h	2 h 5 m	8 h 35 m
XAVC S HD 120p 100M/100p 100M	9 m	35 m	1 h 15 m	5 h 15 m
XAVC S HD 120p 60M/100p 60M	10 m	1 h	2 h 5 m	8 h 35 m
XAVC S HD 60p 50M/50p 50M	15 m	1 h 15 m	2 h 35 m	10 h 25 m
XAVC S HD 60p 25M/50p 25M	30 m	2 h 25 m	5 h	20 h 10 m
XAVC S HD 30p 50M/25p 50M	15 m	1 h 15 m	2 h 35 m	10 h 25 m
XAVC S HD 30p 16M/25p 16M	50 m	3 h 50 m	7 h 45 m	31 h 30 m
XAVC S HD 24p 50M*/–	15 m	1 h 15 m	2 h 35 m	10 h 25 m
AVCHD 60i 24M(FX)/50i 24M(FX)	40 m	2 h 55 m	6 h	24 h 15 m
AVCHD 60i 17M(FH)/50i 17M(FH)	55 m	4 h 5 m	8 h 15 m	33 h 15 m

\* Only when [NTSC/PAL Selector] is set to NTSC.

Continuous movie shooting is possible for a maximum of approximately 29 minutes at a time with the camera's default settings and an ambient temperature of approximately 25°C (77°F).

(a product specification limit)



### Note

- The recordable time of movies varies because the camera is equipped with VBR (Variable Bit-Rate), which automatically adjusts image quality depending on the shooting scene. When you record a fast-moving subject, the image is clearer but the recordable time is shorter because more memory is required for recording. The recordable time also varies depending on the shooting conditions, the subject or the image quality/size settings.
- The times shown are recordable times using a Sony memory card.

### Notes on continuous movie recording

- High-quality movie recording and high-speed continuous shooting require large amounts of power. Therefore, if you continue to shoot, the temperature inside the camera will rise, especially that of the image sensor. In such cases, the

camera will turn off automatically because the surface of the camera is heated to a high temperature or the high temperature affects the quality of the images or the internal mechanism of the camera.

- The duration of time available for movie recording varies with the temperature, file format/record setting for movies, Wi-Fi network environment, or condition of the camera before you start recording. If you frequently recompose or shoot images after the power is turned on, the temperature inside the camera will rise and the recording time available will be shorter.
- If the  icon appears, the temperature of the camera has risen.
- If the camera stops movie recording due to a high temperature, leave it for some time with the power turned off. Start recording after the temperature inside the camera drops fully.
- If you observe the following points, you will be able to record movies for longer periods of time.
  - Keep the camera out of direct sunlight.
  - Turn the camera off when it is not being used.
  
- When [ File Format] is set to [AVCHD], the file size of movies is limited to approx. 2 GB. If the movie file size reaches approx. 2 GB during recording, a new movie file will be created automatically.



Digital Still Camera  
DSC-RX10M4

## Using the AC Adaptor/battery charger abroad

---

You can use the battery charger (sold separately) and the AC Adaptor (supplied) in any country or region where the power supply is within 100 V to 240 V AC and 50 Hz/60 Hz.

Depending on the country/region, a converting plug adaptor may be needed to connect to a wall outlet (wall socket). Consult a travel agency, etc., and prepare one in advance.

### Note

- Do not use an electronic voltage transformer as doing so may cause a malfunction.

Digital Still Camera  
DSC-RX10M4

## AVCHD format

---

The AVCHD format was developed for high-definition digital video cameras when recording an HD (High-Definition) signal using high-efficiency compression coding technology. The MPEG-4 AVC/H.264 format is used to compress video data, and the Dolby Digital or Linear PCM system is used to compress audio data.

The MPEG-4 AVC/H.264 format is capable of compressing images at higher efficiency than that of the conventional image compressing format.

- As the AVCHD format uses compression coding technology, the picture may be unstable in scenes where the screen, angle of view, or brightness, etc. change drastically, but this is not a malfunction.

Digital Still Camera  
DSC-RX10M4

## License

---

### Notes on the License

This product comes with software that are used based on licensing agreements with the owners of that software. Based on requests by the owners of copyright of these software applications, we have an obligation to inform you of the following. Licenses (in English) are recorded in the internal memory of your product. Establish a Mass Storage connection between the product and a computer to read licenses in the "PMHOME" - "LICENSE" folder.

THIS PRODUCT IS LICENSED UNDER THE AVC PATENT PORTFOLIO LICENSE FOR THE PERSONAL USE OF A CONSUMER OR OTHER USES IN WHICH IT DOES NOT RECEIVE REMUNERATION TO  
(i) ENCODE VIDEO IN COMPLIANCE WITH THE AVC STANDARD ("AVC VIDEO")  
AND/OR  
(ii) DECODE AVC VIDEO THAT WAS ENCODED BY A CONSUMER ENGAGED IN A PERSONAL ACTIVITY AND/OR WAS OBTAINED FROM A VIDEO PROVIDER LICENSED TO PROVIDE AVC VIDEO.  
NO LICENSE IS GRANTED OR SHALL BE IMPLIED FOR ANY OTHER USE. ADDITIONAL INFORMATION INCLUDING THAT RELATING TO PROMOTIONAL, INTERNAL AND COMMERCIAL USES AND LICENSING MAY BE OBTAINED FROM MPEG LA, L.L.C.  
SEE [HTTP://WWW.MPEGLA.COM](http://www.mpegla.com)

### On GNU GPL/LGPL applied software

The software that is eligible for the following GNU General Public License (hereinafter referred to as "GPL") or GNU Lesser General Public License (hereinafter referred to as "LGPL") are included in the product.

This informs you that you have a right to have access to, modify, and redistribute source code for these software programs under the conditions of the supplied GPL/LGPL.

Source code is provided on the web.



Use the following URL to download it.

<http://oss.sony.net/Products/Linux/>

We would prefer you do not contact us about the contents of source code.

## Trademarks

---

- Memory Stick and  are trademarks or registered trademarks of Sony Corporation.
- XAVC S and  are registered trademarks of Sony Corporation.
- AVCHD and AVCHD logotype are trademarks of Panasonic Corporation and Sony Corporation.
- Mac is a trademark of Apple Inc., registered in the United States and other countries.
- IOS is a registered trademark or trademark of Cisco Systems Inc.
- iPhone and iPad are trademarks of Apple Inc., registered in the U.S. and other countries.
- Blu-ray Disc™ and Blu-ray™ are trademarks of the Blu-ray Disc Association.
- DLNA and DLNA CERTIFIED are trademarks of Digital Living Network Alliance.
- Dolby, Dolby Audio and double-D symbol are trademarks of Dolby Laboratories.
- The terms HDMI and HDMI High-Definition Multimedia Interface, and the HDMI Logo are trademarks or registered trademarks of HDMI Licensing Administrator, Inc. in the United States and other countries.
- Microsoft and Windows are registered trademarks or trademarks of Microsoft Corporation in the United States and/or other countries.
- SDXC logo is a trademark of SD-3C, LLC.
- Facebook and the “f” logo are trademarks or registered trademarks of Facebook, Inc.
- Android and Google Play are trademarks or registered trademarks of Google Inc.
- YouTube and the YouTube logo are trademarks or registered trademarks of Google Inc.
- Wi-Fi, the Wi-Fi logo and Wi-Fi Protected Setup are registered trademarks or trademarks of the Wi-Fi Alliance.
- The N Mark is a trademark or registered trademark of NFC Forum, Inc. in the United States and in other countries.
- The Bluetooth® word mark and logos are registered trademarks owned by the Bluetooth SIG, Inc. and any use of such marks by Sony Corporation is under license.
- QR code is a trademark of Denso Wave Inc.
- In addition, system and product names used in this manual are, in general, trademarks or registered trademarks of their respective developers or manufacturers. However, the ™ or ® marks may not be used in all cases in this manual.

## Troubleshooting

---

If you experience trouble with the product, try the following solutions.

- 1 If a message such as “C/E:□□:□□” appears on the screen, refer to the self-diagnosis display.
- 2 Remove the battery pack, wait for about one minute, re-insert the battery pack, then turn on the power.
- 3 Initialize the settings.
- 4 Consult your dealer or local authorized service facility. Additional information on this product and answers to frequently asked questions can be found at our Customer Support Website.  
<http://www.sony.net/>

---

### Related Topic

- [Self-diagnosis display](#)
- [Setting Reset](#)

Digital Still Camera  
DSC-RX10M4

## Self-diagnosis display

---

If a code starting with a letter of the alphabet appears, the self-diagnosis function on this product is working. The last two digits (indicated by □□) will differ depending on the state of this product.

If you cannot solve the problem even after trying the following corrective actions a few times, this product may need repair. Contact your Sony dealer or local authorized Sony service facility.

### C:32:□□

- There is trouble with the product's hardware. Turn the power off and on again.

### C:13:□□

- This product cannot read or write data on the memory card. Try turning off and on this product again, or taking out and inserting the memory card several times.
- An unformatted memory card is inserted. Format the memory card.
- The inserted memory card cannot be used with this product, or the data is damaged. Insert a new memory card.

### E:61:□□

### E:62:□□

### E:91:□□

- A product malfunction has occurred. Initialize this product, then turn the power on again.

### E:94:□□

- There is a malfunction when writing or deleting data. Repair is required. Contact your Sony dealer or local authorized Sony service facility. Be prepared to give all numbers in the error code beginning from the E.

---

### Related Topic

- [Format](#)
- [Setting Reset](#)

Digital Still Camera  
DSC-RX10M4

## Warning messages

---

### Set Area/Date/Time.

- Set the area, date and time. If you have not used the product for a long time, charge the internal rechargeable backup battery.

### Unable to use memory card. Format?

- The memory card was formatted on a computer and the file format was modified. Select [Enter] and then format the memory card. You can use the memory card again, however, all previous data in the memory card is erased. It may take some time to complete the format. If the message still appears, change the memory card.

### Memory Card Error

- An incompatible memory card is inserted.
- Formatting has failed. Format the memory card again.

### Unable to read memory card. Reinsert memory card.

- An incompatible memory card is inserted.
- The memory card is damaged.
- The terminal section of the memory card is dirty.

### Memory card locked.

- You are using a memory card with a write-protect switch or a delete-protect switch with the switch set to the LOCK position. Set the switch to the record position.

### Cannot open the shutter since the memory card is not inserted.

- No memory card has been inserted.
- To release the shutter without inserting a memory card into the camera, set [Release w/o Card] to [Enable]. In this case, images will not be saved.

### This memory card may not be capable of recording and playing normally.

- An incompatible memory card is inserted.

### Processing...

- When performing noise reduction, the reduction process takes place. You cannot do any further shooting during this reduction process.

### Unable to display.

- Images recorded with other products or images modified with a computer may not be displayed.
- Processing on the computer such as deletion of the image files may cause inconsistencies in the image database files. Repair the image database files.

### Unable to print.

- You tried to mark RAW images with a DPOF mark.

### **Internal temp. high. Allow it to cool.**

- The product has become hot because you have been shooting continuously. Turn the power off and cool the product and wait until the product is ready to shoot again.



- You have been recording images for a long time, the product temperature has risen.



- The number of images exceeds that for which date management in a database file by the product is possible.



- Unable to register to the database file. Import all the images to a computer using PlayMemories Home and recover the memory card.

### **Image DataBase File error**

- There is something wrong in the Image Database File. Select [Setup] → [Recover Image DB].

### **System Error**

#### **Camera Error. Turn power off then on.**

- Remove the battery pack, and then re-insert it. If the message appears frequently, consult local authorized Sony service facility.

### **Image Database File error. Recover?**

- You cannot record and play back an AVCHD movie because the Image Database File is damaged. Recover the Image Database File following the on-screen instructions.

### **Unable to magnify.**

#### **Unable to rotate image.**

- Images recorded with other products may not be enlarged or rotated.

### **Cannot create more folders.**

- A folder in the memory card has the first three digits "999." You cannot create any more folders on this camera.

---

### **Related Topic**



- [Notes on memory card](#)
- [Format](#)



Digital Still Camera  
DSC-RX10M4

## Recommended pages

---

-  **How to tag the location information on the images**  
You can record the location information on the images. The location information can be acquired via a smartphone.
-  **Touch Focus**  
You can select the subject to focus by the touch operation in the still image and movie recording modes.
-  **DSC-RX10M4 Accessories compatibility information**  
This website provides the accessories compatibility information. (Another window will open.)