

Digital Still Camera

Instruction Manual



“Help Guide” (Web manual)

Refer to “Help Guide” for in-depth instructions on the many functions of the camera.

http://rd1.sony.net/help/dsc/1610/h_zz/

Cyber-shot

Learning more about the camera (“Help Guide”)



“Help Guide” is an on-line manual. You can read the “Help Guide” on your computer or smartphone.

Refer to it for in-depth instructions on the many functions of the camera.

URL:

http://rd1.sony.net/help/dsc/1610/h_zz/



Viewing the Guide

This camera is equipped with a built-in instruction guide.

In-Camera Guide

You can use [Custom Key(Shoot.)] to assign In-Camera Guide to the desired button.

The In-Camera Guide displays explanations for the currently selected menu function or setting.

- ① MENU button →  (Custom Settings) → [Custom Key(Shoot.)] → Select the desired button assigned to the function. → [In-Camera Guide]
- ② Press the MENU button and use the control wheel to select a MENU item whose explanation you want to read, and then press the button to which [In-Camera Guide] is assigned.

Owner's Record

Record the model and serial number (which are located on the product) in the space provided below. Refer to these numbers whenever you call your Sony dealer regarding this product.

Model No. DSC-

Serial No. _____

WARNING

To reduce fire or shock hazard, do not expose the unit to rain or moisture.

IMPORTANT SAFETY INSTRUCTIONS -SAVE THESE INSTRUCTIONS DANGER TO REDUCE THE RISK OF FIRE OR ELECTRIC SHOCK, CAREFULLY FOLLOW THESE INSTRUCTIONS

If the shape of the plug does not fit the power outlet, use an attachment plug adaptor of the proper configuration for the power outlet.

CAUTION

Battery pack

If the battery pack is mishandled, the battery pack can burst, cause a fire or even chemical burns. Observe the following cautions.

- Do not disassemble.
- Do not crush and do not expose the battery pack to any shock or force such as hammering, dropping or stepping on it.
- Do not short circuit and do not allow metal objects to come into contact with the battery terminals.
- Do not expose to high temperature above 60°C (140°F) such as in direct sunlight or in a car parked in the sun.
- Do not incinerate or dispose of in fire.
- Do not handle damaged or leaking lithium ion batteries.
- Be sure to charge the battery pack using a genuine Sony battery charger or a device that can charge the battery pack.
- Keep the battery pack out of the reach of small children.
- Keep the battery pack dry.
- Replace only with the same or equivalent type recommended by Sony.
- Dispose of used battery packs promptly as described in the instructions.

Use a nearby wall outlet (wall socket) when using the supplied or recommended AC Adaptor/battery charger. If any malfunction occurs while using this product, disconnect the plug from the wall outlet (wall socket) immediately to disconnect from the power source. If you use the product with a charge lamp, note that the product is not disconnected from the power source even when the lamp turns off.

Notice

If static electricity or electromagnetism causes data transfer to discontinue midway (fail), restart the application or disconnect and connect the communication cable (USB, etc.) again.

This product has been tested and found compliant with the limits set out in the EMC regulation for using connection cables shorter than 3 meters (9.8 feet).

The electromagnetic fields at the specific frequencies may influence the picture and sound of this unit.

For Customers in the U.S.A. and Canada

RECYCLING LITHIUM-ION BATTERIES

Lithium-Ion batteries are recyclable.

You can help preserve our environment by returning your used rechargeable batteries to the collection and recycling location nearest you.

For more information regarding recycling of rechargeable batteries, call toll free 1-800-822-8837, or visit <http://www.call2recycle.org/>

Caution: Do not handle damaged or leaking Lithium-Ion batteries.

For supplied accessories

This device complies with Part 15 of the FCC Rules. Operation is subject to the following two conditions:

(1) This device may not cause harmful interference, and (2) this device must accept any interference received, including interference that may cause undesired operation.

This equipment complies with FCC/IC radiation exposure limits set forth for an uncontrolled environment and meets the FCC radio frequency (RF) Exposure Guidelines and RSS-102 of the IC radio frequency (RF) Exposure rules. This equipment has very low levels of RF energy that are deemed to comply without testing of specific absorption ratio (SAR).

For Customers in the U.S.A.

If you have any questions about this product, you may call:

Sony Customer Information Center
1-800-222-SONY (7669).

The number below is for the FCC related matters only.

Regulatory Information

Declaration of Conformity

Trade Name: SONY

Model No.: WW411000

Responsible Party: Sony Electronics Inc.

Address: 16535 Via Esprillo,
San Diego, CA 92127
U.S.A.

Telephone No.: 858-942-2230

This device complies with Part 15 of the FCC Rules. Operation is subject to the following two conditions: (1) This device may not cause harmful interference, and (2) this device must accept any interference received, including interference that may cause undesired operation.

This equipment must not be co-located or operated in conjunction with any other antenna or transmitter.



CAUTION

You are cautioned that any changes or modifications not expressly approved in this manual could void your authority to operate this equipment.

Note:

This equipment has been tested and found to comply with the limits for a Class B digital device, pursuant to Part 15 of the FCC Rules.

These limits are designed to provide reasonable protection against harmful interference in a residential installation. This equipment generates, uses, and can radiate radio frequency energy and, if not installed and used in accordance with the instructions, may cause harmful interference to radio communications. However, there is no guarantee that interference will not occur in a particular installation. If this equipment does cause harmful interference to radio or television reception, which can be determined by turning the equipment off and on, the user is encouraged to try to correct the interference by one or more of the following measures:

- Reorient or relocate the receiving antenna.
- Increase the separation between the equipment and receiver.
- Connect the equipment into an outlet on a circuit different from that to which the receiver is connected.
- Consult the dealer or an experienced radio/TV technician for help.

The supplied interface cable must be used with the equipment in order to comply with the limits for a digital device pursuant to Subpart B of Part 15 of FCC Rules.

For Customers in Canada

This device complies with Industry Canada's licence-exempt RSSs. Operation is subject to the following two conditions:

- (1) This device may not cause interference; and
- (2) This device must accept any interference, including interference that may cause undesired operation of the device.

For Customers in Europe

Notice for the customers in the countries applying EU Directives

Manufacturer: Sony Corporation, 1-7-1 Konan Minato-ku Tokyo, 108-0075 Japan
For EU product compliance: Sony Belgium, bijkantoor van Sony Europe Limited, Da Vincilaan 7-D1, 1935 Zaventem, Belgium



Hereby, Sony Corporation, declares that this equipment is in compliance with the essential requirements and other relevant provisions of Directive 1999/5/EC. For details, please access the following URL: <http://www.compliance.sony.de/>

Disposal of waste batteries and electrical and electronic equipment (applicable in the European Union and other European countries with separate collection systems)



This symbol on the product, the battery or on the packaging indicates that the product and the battery shall not be treated as household waste. On

certain batteries this symbol might be used in combination with a chemical symbol. The chemical symbols for mercury (Hg) or lead (Pb) are added if the battery contains more than 0.0005% mercury or 0.004% lead. By ensuring these products and batteries are disposed of correctly, you will help prevent potentially negative consequences for the environment and human health which could otherwise be caused by inappropriate waste handling. The recycling of the materials will help to conserve natural resources.

In case of products that for safety, performance or data integrity reasons require a permanent connection with an incorporated battery, this battery should be replaced by qualified service staff only. To ensure that the battery and the electrical and electronic equipment will be treated properly, hand over these products at end-of-life to the applicable collection point for the recycling of electrical and electronic equipment. For all other batteries, please view the section on how to remove the battery from the product safely. Hand the battery over to the applicable collection point for the recycling of waste batteries.

For more detailed information about recycling of this product or battery, please contact your local Civic Office, your household waste disposal service or the shop where you purchased the product or battery.

For Customers in Singapore

Complies with
IDA Standards
DB00353

For Customers in U.A.E.

TRA
REGISTERED No:
ER0098751/12
DEALER No:
DA0073692/11

For Customers in Malaysia



For Customers in India

Battery Pack

Self Declaration –Conforming to
IS16046:2012, R-41022659

Checking the supplied items

The number in parentheses indicates the number of pieces.

- Camera (1)
- Rechargeable Battery Pack NP-FW50 (1)
- Micro USB Cable (1)
- AC Adaptor (1)
- Power Cord (mains lead) (supplied in some countries/regions) (1)
- Shoulder Strap (1)
- Lens Cap (1)
- Lens Hood (1)
- Shoe Cap (1) (Attached on the camera)
- Eyepiece Cup (1) (Attached on the camera)
- Instruction Manual (this manual) (1)
- Wi-Fi Connection/One-touch (NFC) Guide (1)

This guide explains the functions that require a Wi-Fi connection.

For further details on Wi-Fi functions/One-touch (NFC) functions, refer to the “Wi-Fi Connection/One-touch (NFC) Guide” (supplied) or the “Help Guide” (page 2).



About language setting

Change the screen language before using the camera if necessary (page 18).

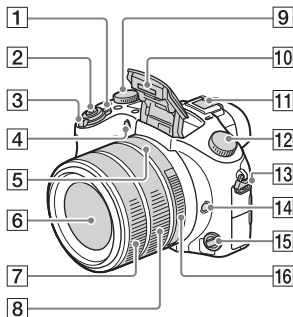
Identifying parts





- 1 ON/OFF (Power) switch
- 2 Shutter button
- 3 For shooting: W/T (zoom) lever
For viewing:  (Index) lever/
Playback zoom lever
- 4 Self-timer lamp/AF illuminator
- 5 Aperture index
- 6 Lens
- 7 Front lens ring
- 8 Rear lens ring
- 9 Exposure compensation dial
- 10 Flash
- 11 Multi interface shoe*
- 12 Mode dial



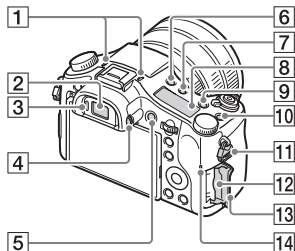

AUTO (Auto Mode)/
P (Program Auto)/
A (Aperture Priority)/
S (Shutter Priority)/
M (Manual Exposure)/
MR (Memory recall)/
 (Movie)/**HFR** (High Frame
 Rate)/ (Sweep Panorama)/
SCN (Scene Selection)

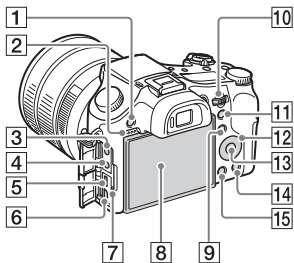

- 13 Hook for Shoulder Strap
- 14 Focus hold button
- 15 Focus mode dial
- 16 Aperture ring





- 1 Microphone
- 2 Viewfinder
- 3 Eye sensor
- 4 Diopter-adjustment dial
- 5 **MOVIE** (Movie) button
- 6  (Flash pop-up) button
- 7  (Display panel illumination)
button
- 8 Display panel
- 9 **C2** button (Custom Button 2)
- 10 **C1** button (Custom Button 1)
- 11 Hook for Shoulder Strap
- 12 Memory card slot
- 13 Memory card cover
- 14 Access lamp

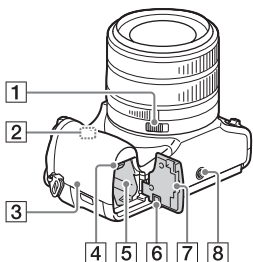

- 1** MENU button
- 2** Speaker
- 3**  (Microphone) jack
- When an external microphone is connected, the camera switches from the internal microphone to the external microphone. If the external microphone is a plug-in-power type, the power of the microphone is supplied by the camera.
- 4**  (Headphones) jack
- 5** Multi/Micro USB Terminal*
- Supports Micro USB compatible device.
- 6** HDMI micro jack
- 7** Charge lamp
- 8** Monitor
- 9** For shooting: Fn (Function) button
For viewing:  (Send to Smartphone) button
- 10** Control dial
- 11** For shooting: AEL (AE lock) button
For viewing:  (Playback zoom) button
- 12** Control wheel

- 13** Center button
- 14** For shooting: **C3** button (Custom Button 3)
For viewing:  (Delete) button
- 15**  (Playback) button



- 1** Aperture Click Switch
- Set the Aperture Click Switch to OFF when shooting movies. If you change the aperture value while shooting a movie with the Aperture Click Switch set to ON, the sound of the aperture ring will be recorded.
- 2** Wi-Fi antenna (built-in)
- 3**  (N Mark)
- Touch the mark when you connect the camera to a smartphone equipped with the NFC function.
 - NFC (Near Field Communication) is an international standard of the short-range wireless communication technology.
- 4** Battery lock lever
- 5** Battery insertion slot

6 Connection plate cover

Use this when using an AC-PW20 AC Adaptor (sold separately). Insert the connection plate into the battery compartment, and then pass the cord through the connection plate cover as shown below.

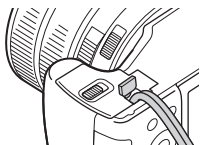

- Make sure that the cord is not pinched when you close the cover.

7 Battery cover

8 Tripod socket hole

- Use a tripod with a screw less than 5.5 mm (7/32 inches) long. Otherwise, you cannot firmly secure the camera, and damage to the camera may occur.

* For details on compatible accessories for the multi interface shoe and the Multi/Micro USB Terminal, visit the Sony website, or consult your Sony dealer or local authorized Sony service facility.

You can also use accessories that are compatible with the accessory shoe. Operations with other manufactures' accessories are not guaranteed.

ni Multi
Interface Shoe

Accessory Shoe

Inserting the battery pack

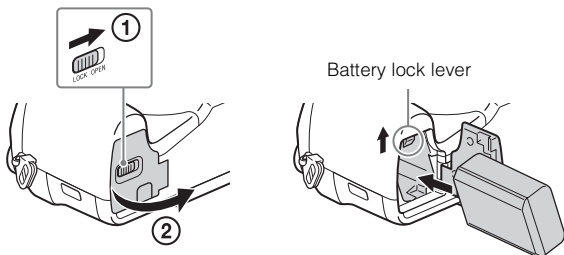

1 Open the cover.

2 Insert the battery pack.

- While pressing the battery lock lever, insert the battery pack as illustrated. Make sure that the battery lock lever locks after insertion.
 - Closing the cover with the battery inserted incorrectly may damage the camera.
-

Charging the battery pack

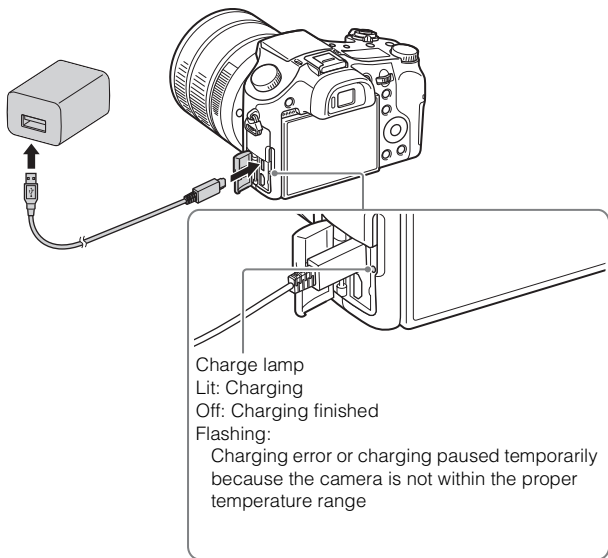

- 1 Connect the camera to the AC Adaptor (supplied), using the micro USB cable (supplied).
- 2 Connect the AC Adaptor to the wall outlet (wall socket).
The charge lamp lights orange, and charging starts.
 - Turn off the camera while charging the battery.
 - You can charge the battery pack even when it is partially charged.
 - When the charge lamp flashes and charging is not finished, remove and re-insert the battery pack.
 - For some countries/regions, connect the power cord (mains lead) to the AC Adaptor, and connect the AC Adaptor to the wall outlet (wall socket).

Notes

- If the charge lamp on the camera flashes when the AC Adaptor is connected to the wall outlet (wall socket), this indicates that charging is temporarily stopped because the temperature is outside the recommended range. When the temperature gets back within the appropriate range, the charging resumes. We recommend charging the battery pack in an ambient temperature of between 10°C to 30°C (50°F to 86°F).
- The battery pack may not be effectively charged if the terminal section of the battery is dirty. In this case, wipe any dust off lightly using a soft cloth or a cotton swab to clean the terminal section of the battery.
- Connect the AC Adaptor (supplied) to the nearest wall outlet (wall socket). If malfunctions occur while using the AC Adaptor, disconnect the plug from the wall outlet (wall socket) immediately to disconnect from the power source.
- When charging is finished, disconnect the AC Adaptor from the wall outlet (wall socket).
- Be sure to use only genuine Sony brand battery packs, micro USB cable (supplied) and AC Adaptor (supplied).
- Power is supplied during shooting/playback if the camera is connected to a wall outlet (wall socket) with the AC-PW20 (sold separately) AC adaptor.

■ Charging time (Full charge)

The charging time is approximately 150 min. using the AC Adaptor (supplied). The charge lamp lights up and then turns off immediately when the battery pack is fully charged.

Notes

- The above charging time applies when charging a fully depleted battery pack at a temperature of 25°C (77°F). Charging may take longer depending on conditions of use and circumstances.

■ Charging by connecting to a computer

The battery pack can be charged by connecting the camera to a computer using a micro USB cable. Connect the camera to the computer with the camera turned off.

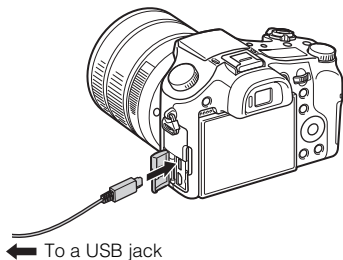

Notes

- If the camera is connected to a laptop computer that is not connected to a power source, the laptop battery level decreases. Do not charge for an extended period of time.
- Do not turn on/off or restart the computer, or wake the computer to resume from sleep mode when a USB connection has been established between the computer and the camera. That may cause the camera to malfunction. Before turning on/off, or restarting the computer or waking the computer from sleep mode, disconnect the camera and the computer.
- No guarantees are made for charging using a custom-built computer or a modified computer.

Battery life and number of images that can be recorded and played back

		Battery life	Number of images
Shooting (still images)	Monitor	—	Approx. 420 images
	Viewfinder	—	Approx. 370 images
Typical movie shooting	Monitor	Approx. 65 min.	—
	Viewfinder	Approx. 70 min.	—
Continuous movie shooting	Monitor	Approx. 120 min.	—
	Viewfinder	Approx. 130 min.	—
Viewing (still images)		Approx. 315 min.	Approx. 6300 images

Notes

- The above number of images applies when the battery pack is fully charged. The number of images may decrease depending on the conditions of use.
- The number of images that can be recorded is for shooting under the following conditions:
 - Using Sony Memory Stick PRO Duo™ (Mark2) media (sold separately)
 - The battery pack is used at an ambient temperature of 25°C (77°F).
 - [Display Quality] is set to [Standard]
- The number for “Shooting (still images)” is based on the CIPA standard, and is for shooting under the following conditions:
(CIPA: Camera & Imaging Products Association)
 - DISP is set to [Display All Info.].
 - Shooting once every 30 seconds.
 - The zoom is switched alternately between the W and T ends.
 - The flash strobes once every two times.
 - The power turns on and off once every ten times.
- The numbers of minutes for movie shooting are based on the CIPA standard, and are for shooting under the following conditions:
 - [Record Setting]: XAVC S HD 60p 50M/50p 50M
 - Typical movie shooting: Battery life based on repeatedly starting/stopping shooting, zooming, turning on/off, etc.
 - Continuous movie shooting: Battery life based on non-stop shooting until the limit (29 minutes) has been reached, and then continued by pressing the MOVIE button again. Other functions, such as zooming, are not operated.

Supplying power

You can use the AC Adaptor (supplied) to supply power during shooting or playing back images, reducing battery pack consumption.

Notes

- The camera will not activate if there is no remaining battery. Insert a sufficiently charged battery pack into the camera.
- If you use the camera while power is being supplied from a wall outlet (wall socket), make sure that the icon () displays on the monitor.
- Do not remove the battery pack while power is being supplied from a wall outlet (wall socket). If you remove the battery pack, the camera will turn off.
- Do not remove the battery pack while the access lamp (page 8) is lit. The data on the memory card may be damaged.
- As long as the power is on, the battery pack will not be charged even if the camera is connected to the AC Adaptor.
- Under certain conditions, power may be supplied from the battery supplementarily even if you are using the AC Adaptor.
- While power is being supplied via USB connection, the temperature inside the camera will rise and the continuous recording time may be shortened.

Inserting a memory card (sold separately)

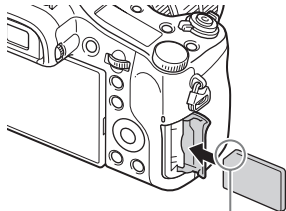
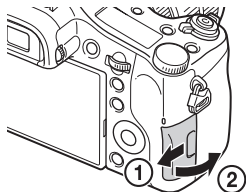

Ensure the notched corner faces correctly.

1 Open the cover.

2 Insert the memory card.

- With the notched corner facing as illustrated, insert the memory card until it clicks into place.

3 Close the cover.

Memory cards that can be used

Memory card	For still images	For movies		
		MP4	AVCHD	XAVC S
Memory Stick PRO Duo	✓	✓ (Mark2 only)	✓ (Mark2 only)	—
Memory Stick PRO-HG Duo™	✓	✓	✓	✓*1
Memory Stick Micro™ (M2)	✓	✓ (Mark2 only)	✓ (Mark2 only)	—
SD memory card	✓	✓*2	✓*2	—
SDHC memory card	✓	✓*2	✓*2	✓*3
SDXC memory card	✓	✓*2	✓*2	✓*3
microSD memory card	✓	✓*2	✓*2	—
microSDHC memory card	✓	✓*2	✓*2	✓*3
microSDXC memory card	✓	✓*2	✓*2	✓*3

*1 Movies cannot be recorded in 100 Mbps or more.

*2 SD Speed Class 4: **CLASS 4** or faster, or UHS Speed Class 1: **U1** or faster

*3 Memory cards that fulfill all of the following conditions:

– Capacity of 4 GB or more

– SD Speed Class 10: **CLASS 10**, or UHS Speed Class 1: **U1** or faster

When recording in 100 Mbps or more, UHS Speed Class 3: **U3** is required.

- For details on the number of recordable still images and recordable duration of movies, refer to pages 33 to 34. Check the tables to select a memory card with the desired capacity.

Notes

- When an SDHC memory card is used to record XAVC S movies over extended periods of time, the recorded movies will be divided into files of 4 GB. The divided files can be integrated into a single file using PlayMemories Home™.
- Not all memory cards are guaranteed to operate correctly. For memory cards produced by manufacturers other than Sony, consult the manufacturers of the products.
- When using Memory Stick Micro media or microSD memory cards with this camera, make sure to use with the appropriate adaptor.

■ To remove the memory card/battery pack

Memory card: Push the memory card in once to eject the memory card.

Battery pack: Slide the battery lock lever. Be sure not to drop the battery pack.

Notes

- Never remove the memory card/battery pack when the access lamp (page 8) is lit. This may cause damage to data in the memory card.

Setting the language and the clock

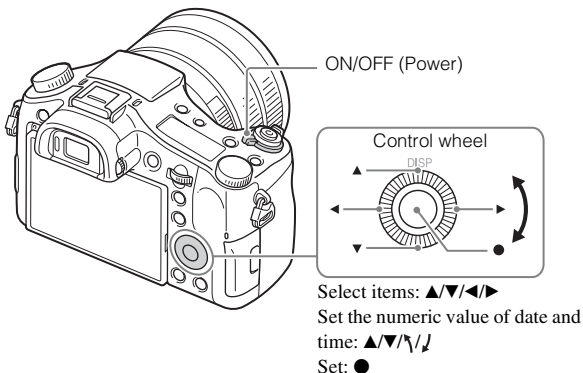

1 Set the ON/OFF (Power) switch to ON.

Language setting screen is displayed when you turn on the camera for the first time.

- It may take time for the power to turn on and allow operation.

2 Select a desired language, then press ● on the control wheel.

Date & Time setting screen is displayed.

3 Check that [Enter] is selected on the screen, then press ●.

4 Select a desired geographic location by following the on-screen instructions, then press ●.

5 Set [Daylight Savings], [Date/Time] and [Date Format], then press ●.

- When setting [Date/Time], midnight is 12:00 AM, and noon is 12:00 PM.

6 Check that [Enter] is selected, then press ●.

Shooting still images/movies

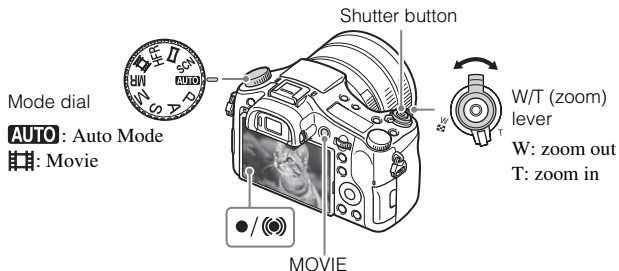

Shooting still images

- 1** Press the shutter button halfway down to focus.
When the image is in focus, a beep sounds and the ● or (●) indicator lights.
 - When the camera cannot focus automatically, the ● indicator flashes.
 - 2** Press the shutter button fully down to shoot an image.
-

Shooting movies

- 1** Press the MOVIE (Movie) button to start recording.
 - Use the W/T (zoom) lever to change the zoom scale.
 - 2** Press the MOVIE button again to stop recording.
-

Notes

- Do not pull up the flash manually. This may cause a malfunction.
- The maximum aperture depends on the focal length. The aperture cannot be opened wider than the maximum even if you set a smaller value using the aperture ring. Check the correct aperture value on the monitor.
- When using the zoom function while shooting a movie, the sound of the camera operating will be recorded. Sound from the camera tends to be recorded particularly when [Zoom Speed] is set to [Fast] and when [Zoom Func. on Ring] is set to [Quick]. The sound of the MOVIE button when movie recording is finished or the sound of [Zoom Assist] operation may also be recorded.
- Continuous movie shooting is possible for a maximum of approximately 29 minutes at one time with the camera's default settings and when the ambient temperature is approximately 25°C (77°F). When movie recording is finished, you can restart recording by pressing the MOVIE button again. Recording may stop to protect the camera depending on the ambient temperature.

Viewing images

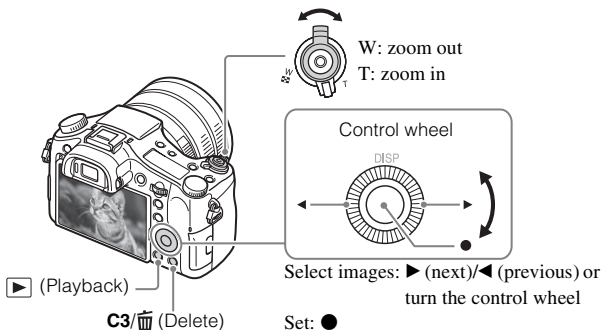

1 Press the ▶ (Playback) button.

■ Selecting next/previous image

Select an image by pressing ▶ (next)/◀ (previous) on the control wheel or by turning the control wheel. Press ● in the center of the control wheel to view

GB movies.

■ Deleting an image

- ① Press the **C3/🗑️** (Delete) button.
- ② Select [Delete] with **▲** on the control wheel, then press **●**.

■ Returning to shooting images

Press the shutter button halfway down.

Introduction of other functions

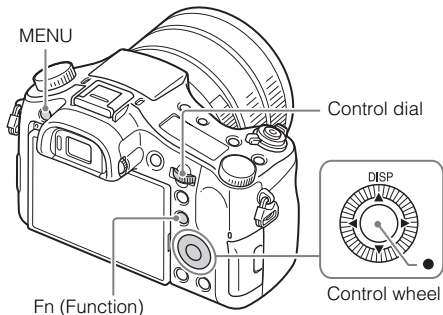

■ Control wheel

DISP (Display Contents): Allows you to change the screen display.

● (Focus Standard): If you press this key when the [Focus Area] is set to [Flexible Spot] or [Expand Flexible Spot], you can change the position of the focus area by pressing **▲/▼/◀/▶** on the control wheel. Also, you can change the position of the focus area while shooting still images. Depending on the options selected in [Focus Area] or [Center Lock-on AF], the available functions varies when pressing the key.

■ Fn (Function) button

Allows you to register 12 functions and recall those functions when shooting.







- ① Press the Fn (Function) button.
- ② Select the desired function by pressing **▲/▼/◀/▶** on the control wheel.
- ③ Select the setting value by turning the control wheel.
 - Some setting values can be finely adjusted by turning the control dial.





■ Control dial





You can instantly change the appropriate setting for each shooting mode just by turning the control dial.

■ Menu Items



(Camera Settings)





 Image Size	Selects the size of still images.
 Aspect Ratio	Selects the aspect ratio for still images.
 Quality	Sets the image quality for still images.
Img. Size(Dual Rec)	Sets the size of still images shot when recording a movie.
Quality(Dual Rec)	Sets the image quality for still images shot when recording a movie.
 File Format	Selects the movie file format.
 Record Setting	Selects the size of the recorded movie frame.
Dual Video REC	Sets whether to simultaneously record an XAVC S movie and MP4 movie or an AVCHD movie and MP4 movie.
 HFR Settings	Sets the High Frame Rate shooting settings.
Panorama: Size	Selects the size of panoramic images.
Panorama: Direction	Sets the shooting direction for panoramic images.
Drive Mode	Sets the drive mode, such as for continuous shooting.
Bracket Settings	Sets self-timer shooting in bracket mode, shooting order for exposure bracketing, and white balance bracketing.
Flash Mode	Sets the flash settings.
Flash Comp.	Adjusts the intensity of flash output.
Red Eye Reduction	Reduces the red-eye phenomenon when using flash.
Focus Area	Selects the area of focus.
 AF Illuminator	Sets the AF illuminator, which provides light for a dark scene to aid focusing.
Exposure Comp.	Compensates for the brightness of the entire image.

ISO	Sets the ISO sensitivity.
ISO AUTO Min. SS	Sets the slowest shutter speed at which ISO sensitivity will start to change in [ISO AUTO] mode.
Metering Mode	Selects the method for measuring brightness.
White Balance	Adjusts color tones of an image.
DRO/Auto HDR	Compensates automatically for brightness and contrast.
Creative Style	Selects the desired image processing. You can also adjust contrast, saturation and sharpness.
Picture Effect	Selects the desired effect filter to achieve a more impressive and artistic expression.
Picture Profile	Changes settings such as color and tone.
Rng. of Zoom Assist	Selects the amount to zoom out with the [Zoom Assist] function.
Focus Magnifier	Enlarges the image before shooting so that you can check the focus.
 Long Exposure NR	Sets noise reduction processing for shots with a shutter speed of 1/3 second or longer.
 High ISO NR	Sets noise reduction processing for high-sensitivity shooting.
Center Lock-on AF	Sets the function to track a subject and continue focusing when pressing the center button in the shooting screen.
Smile/Face Detect.	Selects to detect faces and adjust various settings automatically. Sets to automatically release the shutter when a smile is detected.
Auto Dual Rec	Sets the shutter to release automatically when an impressive composition including a person is detected during movie shooting.
 Soft Skin Effect	Sets the Soft Skin Effect and the effect level.
 Auto Obj. Framing	Analyzes the scene when capturing faces, close-ups, or subjects tracked by Lock-on AF function, and automatically trims and saves another copy of the image with a more impressive composition.

Auto Mode	You can shoot selecting either Intelligent Auto or Superior Auto.
Scene Selection	Selects pre-set settings to match various scene conditions.
High Frame Rate	Selects the exposure mode during High Frame Rate shooting to suit your subject or effect.
Movie	Selects the exposure mode to suit your subject or effect.
 SteadyShot	Sets SteadyShot for shooting still images. Reduces blur from camera shake when shooting while holding the camera.
 SteadyShot	Sets SteadyShot for shooting movies.
 Color Space	Changes the range of reproducible colors.
 Auto Slow Shut.	Sets the function that automatically adjusts the shutter speed following the brightness of the environment in movie mode.
Audio Recording	Sets whether to record audio when shooting a movie.
Audio Rec Level	Adjusts the audio recording level during movie recording.
Audio Out Timing	Sets the timing of audio output during the movie recording.
Wind Noise Reduct.	Reduces wind noise during movie recording.
Memory recall	Selects a setting registered in advance when the mode dial is set to MR (Memory recall). Optical zoom scale, etc. can be registered.
Memory	Registers the desired modes or camera settings.

(Custom Settings)

Zebra	Displays stripes to adjust brightness.
 MF Assist	Displays an enlarged image when focusing manually.
Focus Magnif. Time	Sets the length of time the image will be shown in an enlarged form.
 Initial Focus Mag.	Sets the initial magnification when an enlarged image is displayed using [Focus Magnifier].

Grid Line	Sets a grid line display to enable alignment to a structural outline.
 Marker Display	Sets whether to display the marker on the monitor when recording movies.
 Marker Settings	Sets the marker displayed on the monitor when recording movies.
Audio Level Display	Sets whether or not to display the audio level on the screen.
Auto Review	Sets auto review to display the captured image after shooting.
DISP Button	Sets the type of information to be displayed on the monitor or in the viewfinder by pressing DISP on the control wheel.
Peaking Level	Enhances the outline of in-focus ranges with a specific color when focusing manually.
Peaking Color	Sets the color used for the peaking function.
Exposure Set. Guide	Sets the guide displayed when exposure settings are changed in the shooting screen.
Live View Display	Sets whether or not to reflect settings such as exposure compensation in screen display.
 Pre-AF	Sets whether or not to perform auto focus before the shutter button is half pressed.
Zoom Speed	Sets the zooming speed when you operate the zoom lever.
Zoom Setting	Sets whether to use the Clear Image Zoom and Digital Zoom when zooming.
FINDER/MONITOR	Sets the method for switching between the viewfinder and monitor.
Release w/o Card	Sets whether to release the shutter when a memory card is not inserted.
 AEL w/ shutter	Sets whether to perform AEL when the shutter button is half pressed. This is useful when you want to adjust the focus and exposure separately.
 Shutter Type	Sets whether a mechanical shutter or an electronic shutter is used when shooting still images.

Exp.comp.set	Sets whether to reflect exposure compensation value to flash compensation.
Reset EV Comp.	Sets whether to retain the exposure value set without using the exposure dial, or reset the exposure value to 0 when you turn off the camera.
Face Registration	Registers or changes the person to be given priority in the focus.
 Write Date	Sets whether to record a shooting date on the still image.
Video Light Mode	Sets the illumination setting for the HVL-LBPC LED light (sold separately).
Function Menu Set.	Customizes the functions displayed when the Fn (Function) button is pressed.
Custom Key(Shoot.)	Assigning functions to the various keys allows you to perform operations more quickly by pressing the keys when shooting images.
Custom Key(PB)	Assigning functions to the keys allows you to perform operations more quickly by pressing the keys when playing back images.
Lens Ring Setup	Sets which of the focus function or the zoom function to be assigned to the front lens ring and the rear lens ring.
Focus Ring Rotate	Assigns longer-distance and shorter-distance focus to the rotational directions of the lens ring to which the focus function has been assigned.
Zoom Ring Rotate	Assigns zoom in/out to the rotational direction of the lens ring to which the zoom function has been assigned.
Zoom Func. on Ring	Sets the zooming function of the lens ring. When you select [Quick], the zoom position moves in accordance with the degree of rotation of the lens ring. When you select [Step], you can move the zoom position to a fixed step of the focal length.
MOVIE Button	Sets whether to always activate the MOVIE button.

Dial/Wheel Lock	Sets whether to disable the control dial and the control wheel temporarily by using the Fn button when shooting. You can disable/enable the control dial and the control wheel by pressing and holding down the Fn button.
-----------------	--



(Wireless)

Send to Smartphone	Transfers images to display on a smartphone.
Send to Computer	Backs up images by transferring them to a computer connected to a network.
View on TV	You can view images on a network-enabled TV.
One-touch(NFC)	Assigns an application to One-touch (NFC). You can call up the application when shooting by touching an NFC-enabled smartphone to the camera.
Airplane Mode	You can set this device to not perform wireless communications.
WPS Push	You can register the access point to the camera easily by pushing the Wi-Fi Protected Setup™ (WPS) button.
Access Point Set.	You can register your access point manually.
Edit Device Name	You can change the device name under Wi-Fi Direct, etc.
Disp MAC Address	Displays the MAC address of the camera.
SSID/PW Reset	Resets the SSID and password of smartphone connection.
Reset Network Set.	Resets all network settings.

(Application)



Application List	Displays the application list. You can select the application you want to use.
Introduction	Displays instructions on using the application.

(Playback)

Delete	Deletes an image.
View Mode	Sets the way in which images are grouped for playback.
Image Index	Displays multiple images at the same time.
Display Rotation	Sets the playback direction of the recording image.
Slide Show	Shows a slide show.
Rotate	Rotates the image.
 Enlarge Image	Enlarges the playback images.
 Enlarge Init. Mag.	Sets the initial magnification when enlarging an image during playback.
 Enlarge Initial Pos.	Sets the initial position when enlarging an image during playback.
Protect	Protects the images.
Motion Interval ADJ	Adjusts the interval for showing the tracking of subjects in [Motion Shot Video], where the tracking of the subject's motion will be shown when playing back movies.
Specify Printing	Adds a print order mark to a still image.
Photo Capture	Captures the desired scene from a movie to be saved as a still image.

(Setup)

Monitor Brightness	Sets the monitor brightness.
Viewfinder Bright.	Sets the brightness of the electronic viewfinder.
Finder Color Temp.	Sets the color temperature of the viewfinder.
Gamma Disp. Assist	Converts an S-Log image to an ITU709-equivalent image and displays it on the viewfinder or on the monitor.
Volume Settings	Sets the volume for movie playback.
Audio signals	Sets the operating sound of the camera.
Upload Settings	Sets the upload function of the camera when using an Eye-Fi card.

Tile Menu	Sets whether to display the tile menu every time you press the MENU button.
Mode Dial Guide	Turns the mode dial guide (the explanation of each shooting mode) on or off.
Delete confirm.	Sets whether Delete or Cancel is preselected in the Delete confirmation screen.
Display Quality	Sets the display quality.
Pwr Save Start Time	Sets the time intervals to automatically switch to power save mode.
NTSC/PAL Selector*	By changing the TV format of the device, shooting in a different movie format is possible.
Demo Mode	Sets demonstration playback of a movie to on or off.
TC/UB Settings	Sets the time code (TC) and user bit (UB).
HDMI Settings	Sets the HDMI settings.
 4K Output Sel.	Sets how to record and output 4K movies via HDMI when the camera is connected to an external recorder/player that supports 4K.
USB Connection	Sets the USB connection method.
USB LUN Setting	Enhances compatibility by limiting the functions of the USB connection. Set to [Multi] in normal conditions and to [Single] only when the connection between the camera and a computer or AV component cannot be established.
USB Power Supply	Sets whether to supply power via USB connection when the camera is connected to a computer or USB device using a micro USB cable.
 Language	Selects the language.
Date/Time Setup	Sets date and time, and daylight savings.
Area Setting	Sets the location of use.
Copyright Info	Sets copyright information for still images.
Format	Formats the memory card.
File Number	Sets the method used to assign file numbers to still images and movies.

Set File Name	Changes the first 3 characters of the file name for still images.
Select REC Folder	Changes the selected folder for storing still images and movies (MP4).
New Folder	Creates a new folder for storing still images and movies (MP4).
Folder Name	Sets the folder format for still images.
Recover Image DB	Recovers the image database file and enables recording and playback.
Display Media Info.	Displays the remaining recording time of movies and the recordable number of still images on the memory card.
Version	Displays the camera software version.
Setting Reset	Restores settings to their defaults.

* If you switch this item, it will be required to format the memory card in the setting compatible with the PAL or NTSC system respectively. Also, note that it may not be possible to play back movies recorded with the NTSC system on a PAL system TV.

Using software

Installing the following software to your computer will make your camera experience more convenient.

- PlayMemories Home: Imports images to your computer and lets you use them in different ways (page 32).
- Image Data Converter: Displays RAW images and processes them.
- Remote Camera Control: Controls a camera connected to your computer via a USB cable.

You can download and install this software to your computer from the following URLs.

-
- 1 Using the Internet browser on your computer, go to one of the following URLs, and then follow the instructions on the screen to download the desired software.

Windows:

<http://www.sony.co.jp/imsoft/Win/>

Mac:

<http://www.sony.co.jp/imsoft/Mac/>

- An Internet connection is required.
- For details on operation, refer to the support page or Help page of the software.

Notes

- When using Remote Camera Control, select the MENU button →  (Setup) → [USB Connection] → [PC Remote] and then connect the camera to your computer.

Importing images to your computer and using them (PlayMemories Home)

The software PlayMemories Home allows you to import still images and movies to your computer and use them. PlayMemories Home is required for importing XAVC S movies and AVCHD movies to your computer.

<http://www.sony.net/pm/>



Importing images from
your camera



Playing back imported
images



Sharing images on
PlayMemories Online™



For Windows, the following functions are also
available:



Viewing images
on a calendar



Creating
movie
discs



Uploading
images to
network services

Notes

- An Internet connection is required to use PlayMemories Online or other network services. PlayMemories Online or other network services may not be available in some countries or regions.
- If the software PMB (Picture Motion Browser), supplied with models released before 2011, has already been installed on your computer, PlayMemories Home will overwrite it during the installation. Use PlayMemories Home, the successor software of PMB.
- New functions may be installed in PlayMemories Home. Connect the camera to your computer even if PlayMemories Home is already installed on your computer.
- Do not disconnect the micro USB cable (supplied) from the camera while the operating screen or the accessing screen is displayed. Doing so may damage the data.
- To disconnect the camera from the computer, click  on the tasktray, then click [Eject DSC-RX10M3].

Adding functions to the camera

You can add the desired functions to your camera by connecting to the application download website  (PlayMemories Camera Apps™) via the Internet.

<http://www.sony.net/pmca/>

- After installing an application, you can call up the application by touching an NFC-enabled Android smartphone to the N mark on the camera, using the [One-touch(NFC)] function.

Number of still images and recordable time of movies

The number of still images and recordable time may vary depending on the shooting conditions and the memory card.



■ Still images

The table below shows the approximate number of images that can be recorded on a memory card formatted with this camera. The values are defined using Sony standard memory cards for testing.

 **Image Size]: L: 20M**

When  Aspect Ratio] is set to [3:2]*

Quality	Number of still images	
	8 GB	64 GB
Standard	1150 images	9600 images
Fine	690 images	5500 images
Extra fine	510 images	4150 images
RAW & JPEG	235 images	1900 images
RAW	355 images	2850 images

* When the  Aspect Ratio] is set to other than [3:2], you can record more pictures than shown above. (Except when  Quality] is set to [RAW].)

■ Movies

The table below shows the approximate total recording times using a memory card formatted with this camera. The recording time for XAVC S and AVCHD movies is the recording time when shooting with [Dual Video REC] set to [Off].

File Format	Record Setting	Recordable time (h (hour), m (minute))		
		8 GB	32 GB	64 GB
XAVC S 4K	30p 100M/25p 100M	9 m	35 m	1 h 15 m
	30p 60M/25p 60M	15 m	1 h	2 h 5 m
	24p 100M* / -	9 m	35 m	1 h 15 m
	24p 60M* / -	15 m	1 h	2 h 5 m
XAVC S HD	60p 50M/50p 50M	15 m	1 h 15 m	2 h 35 m
	30p 50M/25p 50M	15 m	1 h 15 m	2 h 35 m
	24p 50M* / -	15 m	1 h 15 m	2 h 35 m
	120p 100M/100p 100M	9 m	35 m	1 h 15 m
	120p 60M/100p 60M	15 m	1 h	2 h 5 m
AVCHD	60i 24M(FX)/50i 24M(FX)	40 m	3 h	6 h
	60i 17M(FH)/50i 17M(FH)	55 m	4 h 5 m	8 h 15 m
	60p 28M(PS)/50p 28M(PS)	35 m	2 h 30 m	5 h 5 m
	24p 24M(FX)/25p 24M(FX)	40 m	3 h	6 h
	24p 17M(FH)/25p 17M(FH)	55 m	4 h 5 m	8 h 15 m
MP4	1920×1080 60p 28M/ 1920×1080 50p 28M	35 m	2 h 35 m	5 h 20 m
	1920×1080 30p 16M/ 1920×1080 25p 16M	1 h	4 h 10 m	8 h 25 m
	1280×720 30p 6M/ 1280×720 25p 6M	2 h 35 m	10 h 55 m	22 h

* only when [NTSC/PAL Selector] is set to [NTSC]

- Continuous movie shooting is possible for a maximum of approximately 29 minutes at one time with the camera's default settings and when the ambient temperature is approximately 25°C (77°F). The maximum continuous recording time of an MP4 (28M) format movie is about 20 minutes (limited by the 4 GB file size restriction).
- The recordable time of movies varies because the camera is equipped with VBR (Variable Bit-Rate), which automatically adjusts image quality depending on the shooting scene. When you record a fast-moving subject, the image is clearer but the recordable time is shorter because more memory is required for recording.

The recordable time also varies depending on the shooting conditions, the subject or the image quality/size settings.

Notes on using the camera

Functions built into this camera

- This camera is compatible with 1080 60p or 50p-format movies. Unlike standard recording modes up to now, which record in an interlacing method, this camera records using a progressive method. This increases the resolution, and provides a smoother, more realistic image. Movies recorded in 1080 60p/1080 50p format can be played back only on 1080 60p/1080 50p-supported devices.
- This camera is compatible with 4K 30p/4K 25p/4K 24p recording. Movies can be recorded in a higher resolution than HD format.
- While aboard an airplane, set [Airplane Mode] to [On].

On use and care

Avoid rough handling, disassembling, modifying, physical shock, or impact such as hammering, dropping, or stepping on the product. Be particularly careful of the lens.

Notes on recording/playback

- Before you start recording, make a trial recording to make sure that the camera is working correctly.
- This camera is designed to be dust and moisture-resistant, but is not waterproof or splash-proof.
- Do not directly expose the lens to beams such as laser beams. That may damage the image sensor and cause the camera to malfunction.
- Do not expose the camera to sunlight or shoot sunward for a long time. The internal mechanism may be damaged.
- If moisture condensation occurs, remove it before using the camera.
- Do not shake or strike the camera. It may cause a malfunction and you may not be able to record images. Furthermore, the recording media may become unusable or image data may be damaged.

Do not use/store the camera in the following places

- In an extremely hot, cold or humid place
In places such as in a car parked in the sun, the camera body may become deformed and this may cause a malfunction.
- Storing under direct sunlight or near a heater
The camera body may become discolored or deformed, and this may cause a malfunction.
- In a location subject to rocking vibration
- Near a location that generates strong radio waves, emits radiation or is strongly magnetic place. Otherwise, the camera may not properly record or play back images.
- In sandy or dusty places
Be careful not to let sand or dust get into the camera. This may cause the camera to malfunction, and in some cases this malfunction cannot be repaired.

ZEISS lens

The camera is equipped with a ZEISS lens which is capable of reproducing sharp images with excellent contrast. The lens for the camera has been produced under a quality assurance system certified by ZEISS in accordance with the quality standards of ZEISS in Germany.

Notes on the monitor, electronic viewfinder and lens

- The monitor and electronic viewfinder are manufactured using extremely high-precision technology, and over 99.99% of the pixels are operational for effective use. However, some tiny black and/or bright dots (white, red, blue or green) may appear on the monitor and electronic viewfinder. These dots are a normal result of the manufacturing process, and do not affect the recording.
- Do not hold the camera by the monitor.
- Take care that your fingers or other objects are not caught in the lens when it is operating.

Notes on shooting with the viewfinder

This camera is equipped with an Organic Electro-Luminescence viewfinder with high resolution and high contrast. This viewfinder achieves a wide viewing angle and a long eye relief. The camera is designed to provide an easily viewable viewfinder by appropriately balancing various elements.

- The image may be slightly distorted near the corners of the viewfinder. This is not a malfunction. When you want to check every detail of the entire composition, you can also use the monitor.
- If you pan the camera while looking into the viewfinder or move your eyes around, the image in the viewfinder may be distorted or the color of the image may change. This is a characteristic of the lens or display device and is not a malfunction. When you shoot an image, we recommend that you look at the center area of the viewfinder.

Notes on the flash

- Do not carry the camera by the flash unit, or use excessive strength on it.
- If water, dust or sand get into the open flash unit, it may cause a malfunction.
- Take care that your finger is not in the way when pushing the flash down.
- Do not use the Multi Interface Shoe with a commercially available flash that applies voltage of 250 V or more or has the reverse polarity of the camera. It may cause a malfunction.

Sony accessories

Use only genuine Sony brand accessories, otherwise it may cause a malfunction. Sony brand accessories may not come to market for some countries or regions.

On camera's temperature

Camera body and battery may get warm with use – this is normal.

On the overheat protection

Depending on the camera and battery temperature, you may be unable to record movies or the power may turn off automatically to protect the camera.

A message will be displayed on the screen before the power turns off or you can no longer record movies. In this case, leave the power off and wait until the camera and battery temperature goes down. If you turn on the power without letting the camera and battery cool down enough, the power may turn off again or you may be unable to record movies.

On charging the battery

- If you charge a battery that has not been used for a long time, you may be unable to charge it to the proper capacity.
This is due to the battery characteristics. Charge the battery again.
- Batteries which have not been used for more than a year may have become deteriorated.

Warning on copyright

- Television programs, films, videotapes, and other materials may be copyrighted. Unauthorized recording of such materials may be contrary to the provisions of the copyright laws.
- To prevent [Copyright Info] from being used illegally, leave [Set Photographer] and [Set Copyright] blank when you lend or transfer the camera.
- Sony bears no responsibility for any trouble or damage caused by unauthorized use of [Copyright Info].

No guarantee in the case of damaged content or recording failures

Sony can provide no guarantees in the event of failure to record or loss or damage of recorded images or audio data due to a malfunction of the camera or recording media, etc. We recommend backing up important data.

Cleaning the camera surface

Clean the camera surface with a soft cloth slightly moistened with water, then wipe the surface with a dry cloth. To prevent damage to the finish or casing:

- Do not expose the camera to chemical products such as thinner, benzine, alcohol, disposable cloths, insect repellent, sunscreen or insecticide.

Maintaining the monitor

- Hand cream or moisturizer left on the monitor may dissolve its coating. If you get any on the monitor, wipe it off immediately.
- Wiping forcefully with tissue paper or other materials can damage the coating.
- If fingerprints or debris are stuck to the monitor, we recommend that you gently remove any debris and then wipe the monitor clean with a soft cloth.

Notes on wireless LAN

We assume no responsibility whatsoever for any damage caused by unauthorized access to, or unauthorized use of, destinations loaded on the camera, resulting from loss or theft.

Notes on security when using wireless LAN products

- Always make sure that you are using a secure wireless LAN to avoid hacking, access by malicious third parties, or other vulnerabilities.
- It is important that you set the security settings when using a wireless LAN.
- If a security problem arises because no security precautions are in place or due to any inevitable circumstances when using a wireless LAN, Sony bears no responsibility for the loss or damage.

Notes on High Frame Rate shooting

Playback speed

The playback speed will vary as below depending on the assigned [HFR Frame Rate] and [HFR Record Setting].

HFR Frame Rate	HFR Record Setting		
	24p 50M*	30p 50M/ 25p 50M	60p 50M/ 50p 50M
240fps/250fps	10 times slower	8 times slower/ 10 times slower	4 times slower/ 5 times slower
480fps/500fps	20 times slower	16 times slower/ 20 times slower	8 times slower/ 10 times slower
960fps/1000fps	40 times slower	32 times slower/ 40 times slower	16 times slower/ 20 times slower

* only when [NTSC/PAL Selector] is set to [NTSC].

[HFR Priority Setting] and recordable duration

HFR Priority Setting	HFR Frame Rate	Effective pixel number read out from image sensor	Recordable duration
Quality Priority	240fps/250fps	1824 × 1026	Approx. 2 seconds
	480fps/500fps	1676 × 566	
	960fps/1000fps	1136 × 384	
Shoot Time Priority	240fps/250fps	1676 × 566	Approx. 4 seconds
	480fps/500fps	1136 × 384	
	960fps/1000fps	800 × 270	

Notes

- Sound will not be recorded.
- The movie will be recorded in XAVC S HD format.
- The image becomes out of focus when the subject is too close, such as during macro shooting. Shoot from the shortest shooting distance (W side: Approx. 3 cm (0.10 ft), T side: Approx. 72 cm (2.36 ft) (from the lens)).

Specifications

Camera

[System]

Image device: 13.2 mm × 8.8 mm

(1.0 type) CMOS sensor

Effective pixel number of camera:

Approx. 20.1 Megapixels

Total pixel number of camera:

Approx. 21.0 Megapixels

Lens: ZEISS Vario-Sonnar T* 25×

zoom lens

f = 8.8 mm – 220 mm (24 mm –
600 mm (35 mm film equivalent))

F2.4 (W) – F4 (T)

While shooting movies (HD 16:9):

26 mm – 630 mm^{*1}

While shooting movies (4K 16:9):

28 mm – 680 mm^{*1}

^{*1} When [SteadyShot] is set to
[Standard]

SteadyShot: Optical

File format (Still images):

JPEG (DCF, Exif, MPF Baseline)

compliant, RAW (Sony ARW 2.3

Format), DPOF compatible

File format (Movies):

XAVC S format (XAVC S format
compliant):

Video: MPEG-4 AVC/H.264

Audio: LPCM 2ch (48 kHz 16 bit)

AVCHD format (AVCHD format

Ver. 2.0 compatible):

Video: MPEG-4 AVC/H.264

Audio: Dolby Digital 2ch,

equipped with Dolby Digital Stereo
Creator

- Manufactured under license from
Dolby Laboratories.

Movies (MP4 format):

Video: MPEG-4 AVC/H.264

Audio: MPEG-4 AAC-LC 2ch

Recording media: Memory Stick PRO

Duo media, Memory Stick Micro

media, SD cards, microSD memory
cards

Flash: Flash range (ISO sensitivity

(Recommended Exposure Index)

set to Auto):

Approx. 1.0 m to 10.8 m

(3.28 ft. to 35.43 ft.) (W)/

Approx. 1.0 m to 6.5 m

(3.28 ft. to 21.33 ft.) (T)

[Input/Output connectors]

HDMI connector: HDMI micro jack

Multi/Micro USB Terminal*:

USB communication

USB communication:

Hi-Speed USB (USB 2.0)

Microphone jack:

∅ 3.5 mm Stereo mini jack

Headphones jack:

∅ 3.5 mm Stereo mini jack

* Supports Micro USB compatible
device.

[Viewfinder]

Type: Electronic viewfinder (Organic

Electro-Luminescence)

Total number of dots:

2 359 296 dots

Frame coverage: 100%

Magnification: Approx. 0.70 ×

(35 mm-format equivalent) with

50 mm lens at infinity, -1 m^{-1}

Eye point (CIPA compliant):

Approx. 23 mm from the eyepiece,
approx. 21.5 mm from the eyepiece
frame at -1 m^{-1}

Diopter adjustment:

-4.0 m^{-1} to $+3.0 \text{ m}^{-1}$

[Monitor]

LCD monitor:

7.5 cm (3.0 type) TFT drive

Total number of dots:

1 228 800 dots

[Power, general]

Power: Rechargeable battery pack

NP-FW50, 7.2 V

AC Adaptor AC-UUD12/UUE12,
5 V

Power consumption:

Approx. 2.3 W (during shooting
with the monitor)

Approx. 2.6 W (during shooting
with the viewfinder)

Operating temperature: $0 \text{ }^{\circ}\text{C}$ to $40 \text{ }^{\circ}\text{C}$
($32 \text{ }^{\circ}\text{F}$ to $104 \text{ }^{\circ}\text{F}$)

Storage temperature: $-20 \text{ }^{\circ}\text{C}$ to $+60 \text{ }^{\circ}\text{C}$
($-4 \text{ }^{\circ}\text{F}$ to $+140 \text{ }^{\circ}\text{F}$)

Dimensions (CIPA compliant)

(Approx.):

132.5 mm \times 94.0 mm \times 127.4 mm
(5 1/4 inches \times 3 3/4 inches \times
5 1/8 inches) (W/H/D)

Mass (CIPA compliant) (Approx.):

1 095 g (2 lb 6.7 oz) (including
NP-FW50 battery pack, Memory
Stick PRO Duo media)

Microphone: Stereo

Speaker: Monaural

Exif Print: Compatible

PRINT Image Matching III:

Compatible

[Wireless LAN]

Supported standard: IEEE 802.11 b/g/n

Frequency: 2.4 GHz

Supported security protocols:

WEP/WPA-PSK/WPA2-PSK

Configuration method: Wi-Fi Protected
Setup™ (WPS) / manual

Access method: Infrastructure Mode

NFC: NFC Forum Type 3 Tag
compliant

Model No. WW411000

AC Adaptor AC-UUD12/UUE12

Power requirements: AC 100 V to
240 V, 50 Hz/60 Hz, 0.2 A

Output voltage: DC 5 V, 1.5 A

Rechargeable Battery Pack NP-FW50

Battery type: Lithium-ion battery

Maximum voltage: DC 8.4 V

Nominal voltage: DC 7.2 V



Maximum charge voltage: DC 8.4 V

Maximum charge current: 1.02 A

Capacity: 7.3 Wh (1 020 mAh)

Design and specifications are subject to
change without notice.

Trademarks

- Memory Stick and  are trademarks or registered trademarks of Sony Corporation.
- XAVC S and  are registered trademarks of Sony Corporation.
- “AVCHD Progressive” and “AVCHD Progressive” logotype are trademarks of Panasonic Corporation and Sony Corporation.
- Dolby and the double-D symbol are trademarks of Dolby Laboratories.
- The terms HDMI and HDMI High-Definition Multimedia Interface, and the HDMI Logo are trademarks or registered trademarks of HDMI Licensing LLC in the United States and other countries.
- Windows is a registered trademark of Microsoft Corporation in the United States and/or other countries.
- Mac is a registered trademark of Apple Inc. in the United States and other countries.
- iPhone and iPad are registered trademarks of Apple Inc. in the United States and other countries.
- SDXC logo is a trademark of SD-3C, LLC.
- Android and Google Play are trademarks of Google Inc.
- Wi-Fi, the Wi-Fi logo, Wi-Fi Protected Setup are registered trademarks or trademarks of the Wi-Fi Alliance.
- The N Mark is a trademark or registered trademark of NFC Forum, Inc. in the United States and in other countries.
- DLNA and DLNA CERTIFIED are trademarks of Digital Living Network Alliance.
- Facebook and the “f” logo are trademarks or registered trademarks of Facebook, Inc.
- YouTube and the YouTube logo are trademarks or registered trademarks of Google Inc.
- Eye-Fi is a trademark of Eye-Fi, Inc.
- In addition, system and product names used in this manual are, in general, trademarks or registered trademarks of their respective developers or manufacturers. However, the TM or ® marks may not be used in all cases in this manual.



On GNU GPL/LGPL applied software

The software that is eligible for the following GNU General Public License (hereinafter referred to as “GPL”) or GNU Lesser General Public License (hereinafter referred to as “LGPL”) are included in the product.

This informs you that you have a right to have access to, modify, and redistribute source code for these software programs under the conditions of the supplied GPL/LGPL.

Source code is provided on the web. Use the following URL to download it.

<http://oss.sony.net/Products/Linux/>

We would prefer you do not contact us about the contents of source code. Licenses (in English) are recorded in the internal memory of your product. Establish a Mass Storage connection between the product and a computer to read licenses in the “PMHOME” - “LICENSE” folder.

Additional information on this product and answers to frequently asked questions can be found at our Customer Support Website.
--

<http://www.sony.net/>



<http://www.sony.net/SonyInfo/Support/>

