

INSTRUCTION MANUAL

KETTLE

EN

MANUEL D'UTILISATION

BOUILLOIRE

FR

MANUAL DE USO

HERVIDOR

ES



Important information for the user Informations importantes pour l'utilisateur Información importante para el usuario



Instructions / Instructions / Instrucciones



Description / Description / Descripción



Use / Usage / Uso



Cleaning and maintenance / Nettoyage et entretien / Limpieza y mantenimiento



Safety instructions / Directives de sécurité / Instrucciones de seguridad



Information / Informations / Información



Advice / Conseil / Recomendaciones



Scan the QR code for quick access to the My Smeg Assistant portal
Scannez le code QR pour un accès rapide au portail My SMEG Assistant
Escanee el código QR para acceder rápidamente al portal My Smeg Assistant

MY SMEG
ASSISTANT

Dear Customer, Thank you for purchasing one of our appliances. Our products are unique because they combine iconic style with innovative technical solutions. They match perfectly with other products in our range and work equally well as a standalone design objects in your kitchen. We hope you enjoy using your new appliance!

Cher client, merci beaucoup pour votre achat. Nos produits sont uniques car ils combinent une forte recherche esthétique avec une conception technique innovante. Ils sont coordonnés avec d'autres produits de la gamme et peuvent constituer des éléments de design pour votre cuisine. Nous espérons que vous aimerez utiliser votre nouvel appareil !

Estimado Cliente, Le agradecemos por haber comprado uno de nuestros aparatos. Nuestros productos son únicos porque combinan un estilo icónico con soluciones técnicas innovadoras. Combinan perfectamente con otros productos de nuestra gama y trabajan igual de bien como objetos independientes en su cocina. Le deseamos que pueda aprovechar plenamente su nuevo electrodoméstico.

SMEG S.p.A.

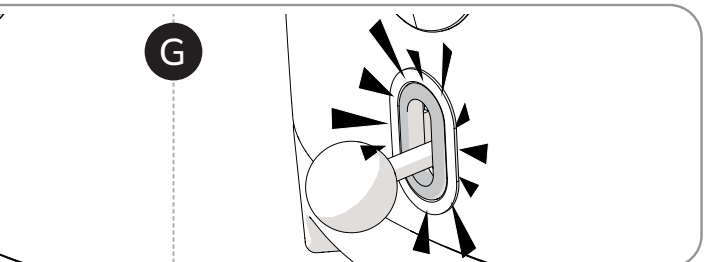
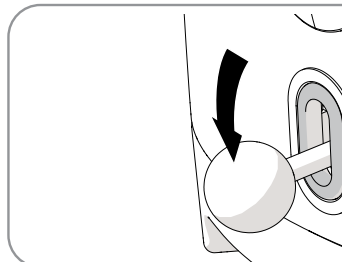
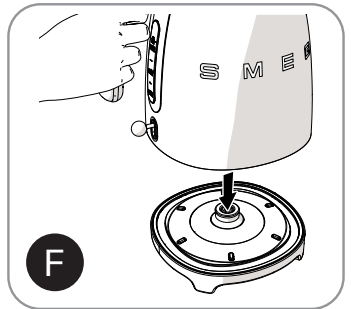
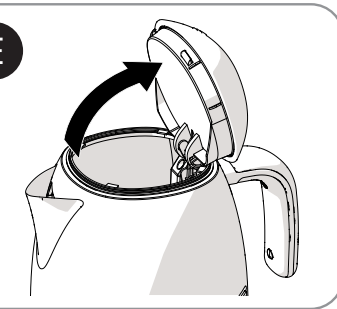
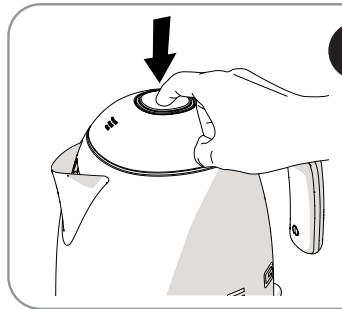
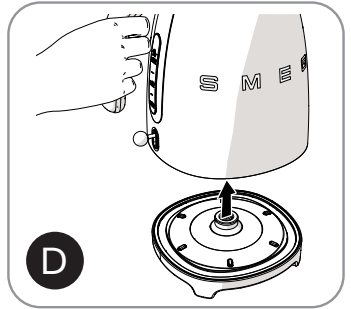
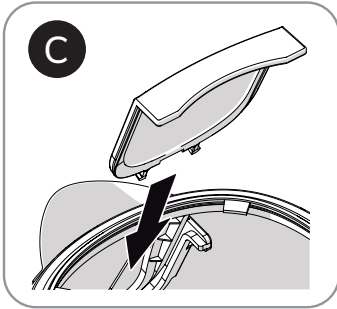
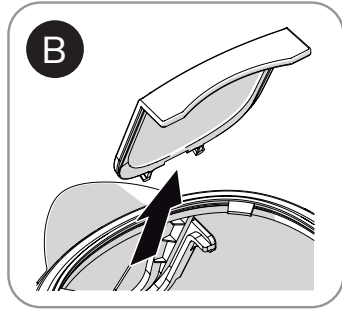
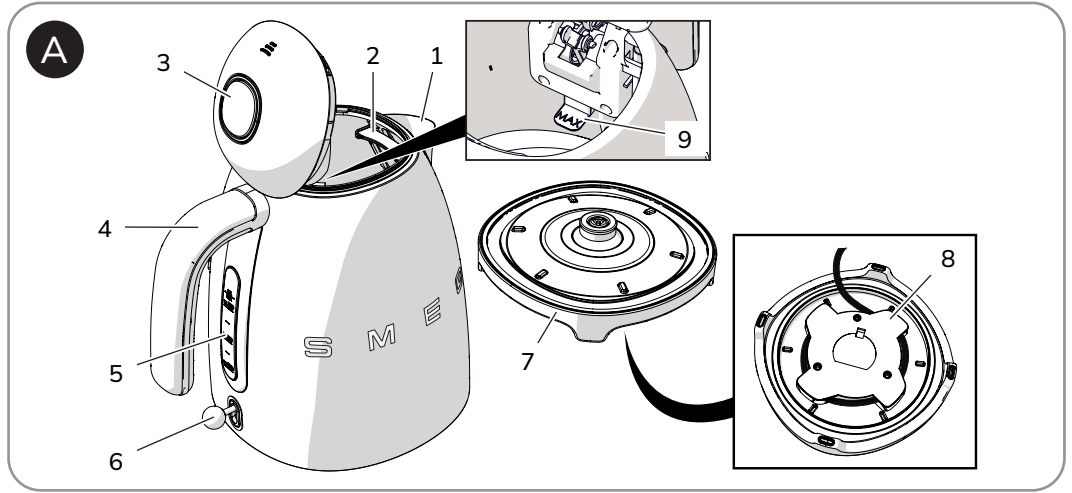

IMPORTANT SAFEGUARDS



WARNING: If the instructions contained in this manual are not followed precisely, a fire or explosion may result causing property damage, personal injury or death.



READ AND SAVE THESE INSTRUCTIONS

Your safety and the safety of others are very important. We have provided many important safety messages throughout this manual and on the appliance. Read all the instructions before using the appliance and always obey all safety messages.



RECOGNIZE SAFETY INFORMATION

This is the safety alert symbol. This symbol alerts you to potential hazards that can result in severe personal injury or death.

UNDERSTAND SIGNAL WORDS

A signal word – DANGER, WARNING, or CAUTION – is used with the safety alert symbol. DANGER denotes the most serious hazards. It means you could be killed or seriously injured if you do not immediately follow the instructions. WARNING means you could be killed or seriously injured if the instructions are not followed. CAUTION indicates a potentially hazardous situation, which, if not avoided, could result in minor to moderate injury.

WARNING



- This appliance is intended for residential use only.
- Use this appliance only for its intended purpose. The manufacturer cannot be held liable for damage caused by improper use of this appliance.
- This appliance complies with current safety regulations. Improper use can result in personal injury and material damage.
- Read all the instructions before installing or using the appliance for the first time.
- Keep these operating instructions in a safe place and pass them on to any future user.



IMPORTANT SAFEGUARDS

The safety messages will inform you of potential hazards, on how to avoid the risk of injury and what can occur if the instructions are not followed.

IMPORTANT: Observe all codes and ordinances in force.

WARNING: For your safety, the instructions contained in this manual must be followed to minimize the risk of fire or explosion and to prevent property damage, personal injury or death.

Do not store or use gasoline or other flammable vapors, liquids or materials near this or any other appliance.



NOTE: This appliance is NOT designed for installation in manufactured (mobile) homes or in recreational vehicles (RVs).

DO NOT install this appliance outdoors.

IMPORTANT SAFEGUARDS



WARNING



To reduce the risk of fire, electrical shock, personal injury, or damage when using the appliance, follow basic safety precautions, including the following:

EN

1 Instructions

This user manual is an integral part of the appliance and must therefore be kept in its entirety and in an accessible place for the whole working life of the appliance.

1.1 Intended use

- Do not use outdoors.
- Only use the appliance indoors and at a maximum altitude of 2000 meters.
- This appliance is intended for household use and similar applications such as:
 - staff kitchen areas in shops, offices and other working environments
 - bed and breakfast facilities / farm accommodation
 - by guests in hotels, motels and other residential accommodation
- Any other use, for example in restaurants, coffee bars and coffee shops is considered improper.
- Only use the appliance to heat water. Never fill the kettle with other liquids.
- This appliance may be used by people of reduced physical, sensory or mental abilities (including children over the age of 8), only if they are supervised by adults or have been trained on

how to use the appliance safely and have understood the dangers associated with its use.

- Children must never play with the appliance.
- Keep the appliance and its cord out of reach of children aged less than 8 years.
- Cleaning and maintenance may be carried out by children who are at least 8 years old only if they are supervised by an adult.
- The use of accessory attachments not recommended by the appliance manufacturer may result in fire, electric shock or injury to persons.
- Close supervision is necessary when any appliance is used by or near children.

1.2 General safety instructions

- Unplug from outlet when not in use and before cleaning. Allow to cool before putting on or taking off parts, and before cleaning the appliance.
- Do not immerse the appliance, the power cord, the plug or the base in water or any other liquid. Do not unplug the appliance with wet hands, or by pulling on the power cord.
- Never wash the appliance in the dishwasher.



IMPORTANT SAFEGUARDS

- For cleaning instructions, please refer to the chapter “Cleaning and maintenance.”
- Do not position the appliance above or near hot surfaces, a hot gas or electric burner, or in a heated oven.
- In the event of a fault, or if the power cable is damaged, the appliance must only be repaired by a qualified technician or an authorized technical support center.
- Any modifications to the appliance will invalidate the warranty.
- Do not let cord hang over edge of table or counter, or touch hot surfaces.

1.3 Caution

- Do not use the kettle if the handle is loose.
- Make sure that the inside bottom of the kettle is completely covered with water before switching it on.
- Do not use appliance for other than intended use.
- Only use the kettle with the base provided.
- Make sure that the lid is correctly closed before switching on the kettle.
- Only use original spare parts. The use of spare parts not approved by the manufacturer could lead to fires, electric shocks or personal injury.
- To disconnect, turn the power control to “off”, then remove plug from wall outlet.

- Scalding may occur if the lid is removed during the brewing cycles.

1.4 Manufacturer liability

The manufacturer declines any liability for damage to persons or property caused by:

- Use of the appliance other than the one envisaged
- Not having read the user manual
- Tampering with any part of the appliance
- Use of non-original spare parts
- Failure to comply with the safety instructions

1.5 Disposal



This appliance must be disposed of separately from other waste (Directive 2012/19/EU).

- The appliance does not contain substances in quantities sufficient to be considered hazardous to health and the environment, in accordance with current European directives.
- Old electrical appliances must not be disposed of together with household waste! To comply with current legislation, old appliances, on reaching the end of their useful lives, should be taken to a disposal facility where they can be sorted. The relevant local authorities or their waste disposal operators can provide further information.
- Take these packing materials to the appropriate recycling center.

IMPORTANT SAFEGUARDS



Fire hazard:

- Do not position the appliance above hot surfaces, cooktop burners, or inside a hot oven.



Danger of burns:

- Do not overfill the kettle (maximum capacity 1.7 liters) to prevent boiling water from being splashed out.
- The surfaces of the kettle may become very hot. Avoid touching hot surfaces; use the handle.
- Wait a few seconds after the kettle has reached boiling temperature, then pour the water out slowly to prevent hot water from spraying or coming out too fast.
- Do not tilt the hot kettle excessively – the boiling water could spray out, with a risk of burns.
- Keep your face at safe distance from the lid to avoid the risk of scalding from escaping steam.
- Let the appliance cool down before cleaning.
- Pay attention: The heating element surface is subject to residual heat after use.



Suffocation hazard due to plastic packaging:

- Do not leave the packaging or any part of it unattended.
- Do not let children play with the plastic bags.



Risk of injury:

- Improper use of the appliance can cause personal injury.



Danger of electrocution:

- Plug into a grounded 3-prong outlet.
- Do not remove the grounding prong.
- Do not use an adapter.
- Do not use an extension cord.
- Avoid spilling liquids onto the power plug and base.
- Unplug the kettle when it is not being used, before cleaning and if you notice any fault.
- Failure to follow these instructions can result in death, fire, or electric shock.



Caution

- To clean surfaces that come into contact with food, follow the special cleaning procedures provided in the instructions.

SAVE THESE INSTRUCTIONS



2 Product description (Fig. A)

- 1) Anti-drip spout
- 2) Scale filter
- 3) Lid with push-push opening
- 4) Handle
- 5) Water level indicator
- 6) ON/OFF lever with indicator light
- 7) 360 degree cordless base
- 8) Cable storage (under base)
- 9) Internal maximum water level indicator



To avoid damaging the appliance, the kettle is equipped with a safety device that automatically turns the lever to the OFF position if the kettle is accidentally switched on without water. If this occurs, let the kettle cool down before refilling.

3 Use

3.1 Before first use

- 1) Remove any stickers from the kettle and clean the outside with a damp cloth.
- 2) Remove the scale filter behind the spout (Fig. B) and wash it under running water.
- 3) Put the filter back in the correct position (Fig. C).

- 4) Remove the kettle from its base (Fig. D), press the button to open the lid (Fig. E) and fill it to the maximum level (5 and 9 - Fig. A).
- 5) Close the lid, place the kettle on its base (Fig. F) and push the lever down to turn it on (Fig. G).
- 6) Wait for the water to boil, then empty the kettle, disposing of the boiling water safely. Repeat this at least three times.

3.2 Operation

If necessary, wind the cord under the base (7 and 8 - Fig. A).

Always use the handle (4 - Fig. A) to lift the kettle and pour out the water.

- 1) Remove the kettle from the base (Fig. D), press the button to open the lid (Fig. E) and fill with water, using the level indicator (5 - Fig. A) as a reference. Avoid filling it with too much or too little water as indicated by the maximum (9 - Fig. A) or minimum level indicators.
- 2) Close the lid and put the kettle back on its base (Fig. F).
- 3) Then insert the plug into the power socket.
- 4) Push the lever downwards to switch the kettle on. The LED lights up and becomes white (Fig. G).
- 5) When the water boils, the lever automatically moves into the OFF position and the LED switches off. Pour out the water.



4 Cleaning and maintenance

4.1 Cleaning the surfaces

To keep the outside surfaces of the kettle in good condition, clean them regularly after use, after allowing them to cool down.

Pour the cleaning product onto a damp cloth and wipe the surface, rinse thoroughly and dry with a soft cloth or a microfiber cloth.

Improper use (risk of damage to surfaces):

- Do not use steam jets to clean the appliance.
- Do not use cleaning products containing chlorine, ammonia or bleach.
- Do not use abrasive or corrosive detergents (e.g. powder products, stain removers and metallic scourers).
- Do not use rough or abrasive materials or sharp metal scrapers.

4.2 Cleaning the filter

- 1) Open the lid (Fig. E) and remove the filter (Fig. B).
- 2) Wash the filter under running water with the aid of a soft brush.
- 3) Put the filter back in position behind the spout (Fig. C).

4.3 Descaling

Improper use: Risk of damaging the appliance



Do not use descaling products for cleaning bathrooms or kitchens or products that contain perfumes.

Regularly removing scale deposits from inside the kettle will prolong your kettle's life, ensuring maximum performance and energy savings.

The kettle can be descaled using specific descaling products. Follow the descaler instructions.

Alternatively, you can use common household vinegar. Proceed as follows:

- 1) Fill the kettle with water (1 liter) and boil it.
- 2) Add white vinegar (0.1 to 0.5 liters depending on the amount of scale).
- 3) Leave it to act overnight.
- 4) Empty the kettle.
- 5) Fill the kettle with water and boil it. Empty the kettle, disposing of the water safely. Repeat this at least twice.



Tips and suggestions

Frequent use or very hard water increases the risk of scale.

Scale build-up can cause the kettle to switch off during use before the water has boiled.

Boiling times could also increase.

If the kettle is used daily, descale it more frequently. If the water is hard, clean more frequently or use purified water.

What to do if...

Problem	Cause	Solution
Pouring water becomes more difficult	Scale build-up on filter	Check that the filter is clean and correctly positioned
The kettle turns off before boiling	The inside base of the kettle has excessive scale build-up	Descale more frequently
	There is too little water in the kettle	Increase the quantity of water until you reach at least the minimum level
The appliance does not turn on	The safety device has tripped due to the kettle being operated without water	Let the kettle cool down before boiling water again
	The plug is not properly inserted in the power socket	Insert the plug into the power socket. Do not use adapters or extensions. Make sure that the main circuit breaker is on
	The cable is defective	Have the cable replaced at an Authorized Service Center
	No power	Make sure that the main circuit breaker is on

The manufacturer reserves the right to make any changes deemed necessary for the improvement of its products without prior notice. The illustrations and descriptions contained in this manual are therefore not binding and are merely indicative.

Le fabricant se réserve le droit d'apporter, sans préavis, toutes les modifications qu'il jugera utiles pour l'amélioration de ses produits. Les illustrations et les descriptions figurant dans ce manuel ne sont pas contraignantes et n'ont qu'une valeur indicative.

El fabricante se reserva el derecho a aportar sin aviso previo todas las modificaciones que considere necesarias para la mejora de sus propios productos. Las ilustraciones y las descripciones contenidas en este manual no comprometen, por tanto, al fabricante y tienen un valor meramente indicativo.