

Hisense

QUICK SETUP GUIDE

Before using the TV, please read this guide thoroughly and retain it for future reference.

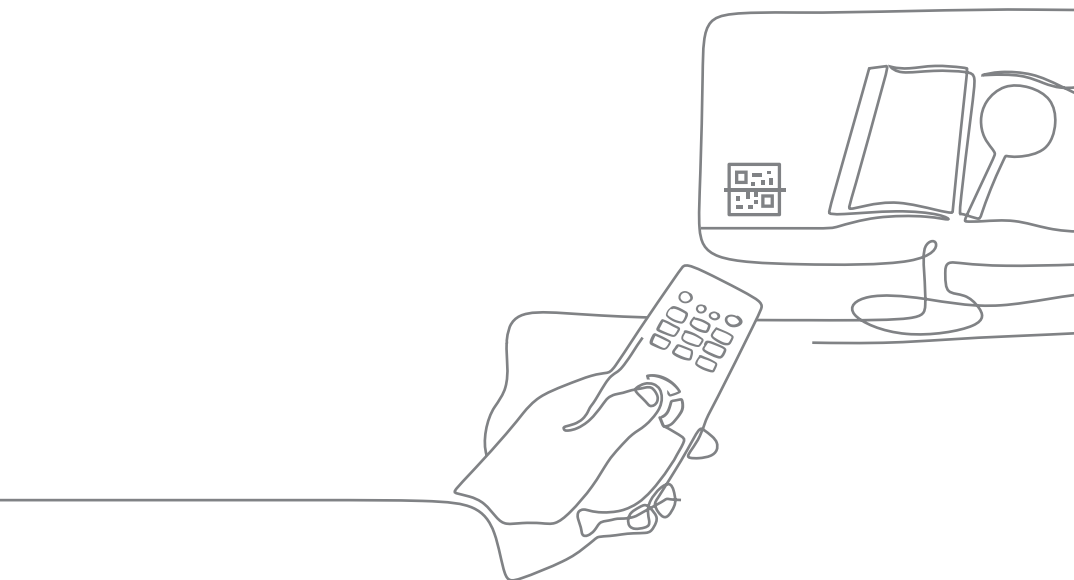

Congratulations on the purchase of your Hisense TV! If you would like to know 'all things Hisense', contact us using the support info:

The model and serial number of the TV is located on the back and/or on one side of the TV. We recommend that you record this if you ever need service.

Country	U.S.A	CANADA	MEXICO
<p>Customer Care Center</p>	<ul style="list-style-type: none"> • Phone: 1-888-935-8880 • Hours of Operation: Monday - Friday: 9 AM to 9 PM EST Saturday - Sunday: 9 AM to 6 PM EST • Service Email: Service@hisense-usa.com <p>USA: Hisense USA Corporation 105 Satellite BLVD Suite I, Suwanee, GA 30024</p>	<ul style="list-style-type: none"> • Phone: 1-855-344-7367 • Hours of Operation: Monday - Friday: 8 AM to 8 PM EST Saturday - Sunday: 9 AM to 6 PM EST, Federal holidays excluded • Service Email: canadasupport@hisense.com <p>CANADA: Hisense Canada Co., Ltd 2283 Argentia Road, Unit 16 Mississauga, ON, Canada L5N 5Z2</p>	<ul style="list-style-type: none"> • Phone: 800-008-8880 • Hours of Operation: Monday - Friday: 9:00-21:00 hrs Saturday: 9:00-15:00 hrs • Service Email: servicio@hisense.com.mx <p>MEXICO IMPORTER: Hisense Mexico S. de R.L. de C.V. Blvd. Miguel de Cervantes Saavedra No 301 Torre Norte Piso 2, Col. Ampliación Granada Miguel Hidalgo, Ciudad de México, C.P. 11520</p>
<p>Hisense Support Page</p>	<p>http://www.hisense-usa.com/support/</p> 	<p>http://www.hisense-canada.com/support/</p> 	<p>https://hisense.com.mx/support/</p>  <p>*Scan to download user manual</p>
<p>Register your TV</p>	<p>http://www.hisense-usa.com/support/register</p> 	<p>http://www.hisense-canada.com/support/productReg.asp</p> 	<p>https://hisense.com.mx/support/register</p> 

Disclaimer

Disclaimer: Subscriptions or other payments may be required to access content through some applications. Some or all of the included or downloaded application services in this Hisense device may not function depending on the Internet connection, local limitations of included applications or other reasons outside of Hisense's control. HISENSE EXPRESSLY DISCLAIMS RESPONSIBILITY FOR ANY APPLICATION SERVICE FROM FUNCTIONING AT ANY TIME, FOR CONTENT IN ANY APPLICATION SERVICE, FOR DISRUPTIONS OF SERVICE, LOCAL OR REGIONAL LIMITATIONS, WARRANTIES OF TITLE, NO INFRINGEMENT, AND FOR IMPLIED WARRANTIES OF MERCHANTABILITY OR FITNESS FOR A PARTICULAR PURPOSE. By purchasing this device, you accept such Disclaimer without any claim on Hisense at any time.

Find what you want

This TV is equipped with this quick setup guide and embedded E-Manual (⚙️ > Settings > System > Advanced System > E-Manual).

On the website (www.hisense.com), you can get the User Manual.

E-Manual support functions



QR Code

Scan to open the E-Manual on your mobile device.



Search

Find the help you are looking for.

This Quick Setup Guide supports the following models:

55U8K / 55U88KM

65U8K / 65U88KM

75U8K / 75U88KM

What's in the box

Your Hisense TV comes with the following items:

- TV
- power cord
- remote control
- 2 base stands
- Quick Setup Guide (this document)
- 1 set of AAA or AA (1.5Vcc) batteries
- Important Safety Information and Warranty Card
- 4 screws

NOTE:

If you need the AV adapter cable, please contact us and we will send it to you for free.

IMPORTANT:

To prevent accidentally discarding items that came with your TV, be sure to **check ALL of the foam** in the carton box.

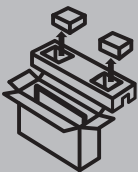

- Please check foam for accessories before discarding.
- Veuillez vérifier la mousse pour qu'il n'y ait pas d'accessoires avant de la jeter.
- Antes de desechar la espuma, asegúrese de retirar todos los accesorios.

Disclaimer: *This Quick Setup Guide is intended as a general guideline to help you set up your TV. Images throughout this document are for illustrative purposes only and may differ from the actual product.*

Getting started

Step 1. Attach stand or mount

Before you start using your TV, attach your TV stand or mount it on the wall.

CAUTION:

- Disconnect the AC power cord before installing a stand or a wall mount bracket.
- The LED display on your TV is fragile. Make sure the TV screen is not scratched or damaged by hard objects or from pressure.
- After the installation is complete, make sure the TV is steady on a table or firmly attached to a wall mount, before removing all protective film, if any.

Attach the TV stand

To attach the TV stand legs to your TV:

1. Carefully place your TV face down on a clean, soft and flat surface.
2. Insert the TV base stands into the bottom slots on your TV.
3. Use the screws provided to secure each base stand tightly.

55" (139.7cm)

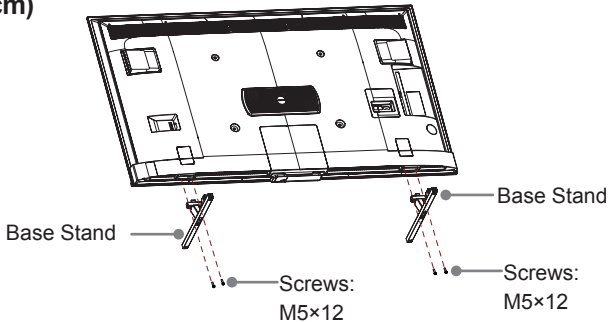

65" (165.1cm) / 75" (190.5cm)

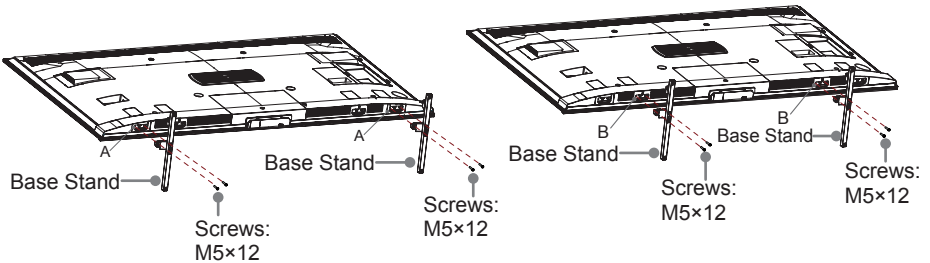

Note: If your table is long enough to place the TV, then insert the base stands into the screw holes 'A' that are shown in the illustration. If your table is not long enough, then insert the base stand into the screw holes 'B' that are shown in the illustration. Note that these two installation methods types cannot be mixed.

Attach the wall mount bracket (not included)

Before you begin the third-party manufacturer instructions, be sure to do the following things:

1. Place the TV face down on a clean, safe and cushioned surface.
2. Remove the TV stand if you have already attached it.
3. Place spacers (not included) in the corresponding bracket holes.

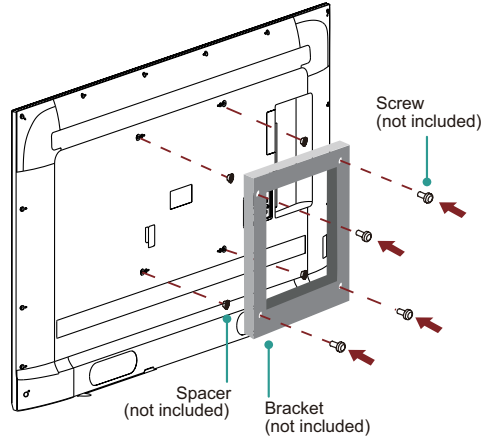

CAUTION:

- Follow instructions provided with the wall mount bracket. If it is not correctly mounted, the TV may fall and cause property damage or personal injury.
- When you attach the mount, be sure to use spacers (provided by the third-party manufacturer) between the TV and the bracket.
- To prevent internal damage to the TV and to ensure it is mounted securely, be sure to use fixing screws (not included) that are 9.5 - 11.5 mm in length when measured from the attaching surface of the rear cover.

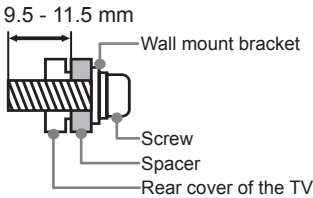

Wall mount hole pattern(mm)	400 × 300 (55")(139.7cm) 400 × 400 (65")(165.1cm) 600 × 400 (75")(190.5cm)
Wall mount screw size	M6 (55"/65")(139.7cm/165.1cm) M8 (75")(190.5cm)

- We do not recommend hanging the TV on a slanted wall, and when wall mounting make sure your television remains parallel to the wall and does not lean forward.

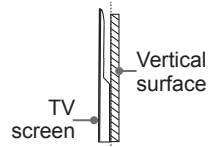



NOTE:

- If installed on a ceiling or slanted wall, or the television installed is not parallel to the wall, the television may fall and result in property damage or severe personal injury.
- If you have additional questions, please contact the wall mount manufacturer or the retailer from which you purchased the TV.
- The diameter and length of the screws differ depending on the wall mount bracket model.

Step 2. Connect devices to your TV

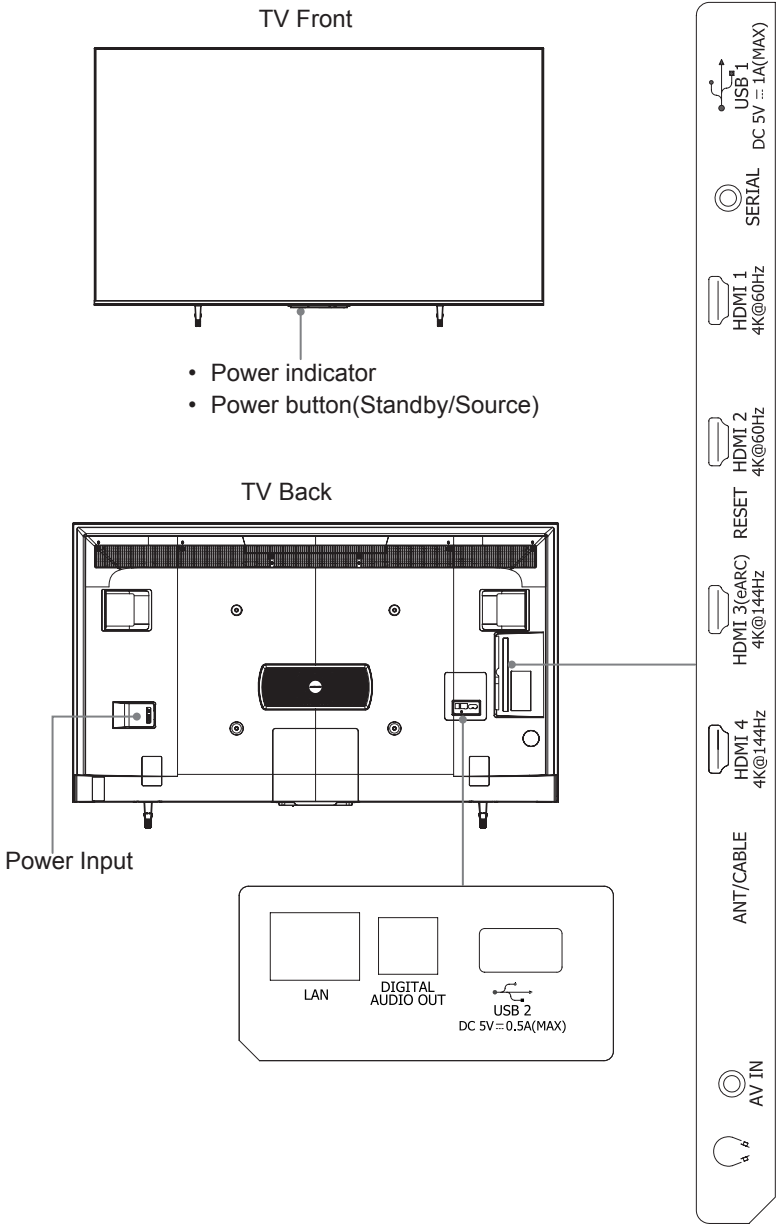
Check to ensure that you have connected right cables for right ports securely. Loose connections can affect the quality of the picture image and color.





Power indicator	The light is white in standby mode.
 Power button (Standby/Source)	<p>When the TV is in standby mode, quick press the power button, and TV will be turned on.</p> <p>When the TV is on, quick press the power button to call up the menu:</p> <ul style="list-style-type: none"> • Quick press to change the selection. • Long press to confirm your selection.
SERIAL	Service use only.
ANT/CABLE	Connect an outdoor VHF/UHF antenna.
HDMI	Connect a High Definition Multimedia Interface (HDMI) cable from an external device.
AV IN	Connect a composite video cable and left-right audio cables from an external AV device.
HEADPHONE / 	Connect headphones to hear audio from the TV. Headphones with microphones are not supported.
RESET	Power off / restart (quick press) Reset your TV back to the factory setting (long press for 5 seconds)
USB	Connect a USB device for browsing photos, music and movies. The rate of speed of USB 3.0 port 10 times faster than the USB 2.0 port. NOTE: You can still plug a USB 2.0 device into a USB 3.0 port; however, the rate of speed will not be as fast. USB 3.0 devices are also backwards compatible with USB 2.0 ports.
LAN	Connect an Ethernet cable to access a network or the Internet. The TV also has a wireless connectivity feature.
DIGITAL AUDIO OUT	Connect an optical cable from an external digital audio system.

Step 3. Get to know controls

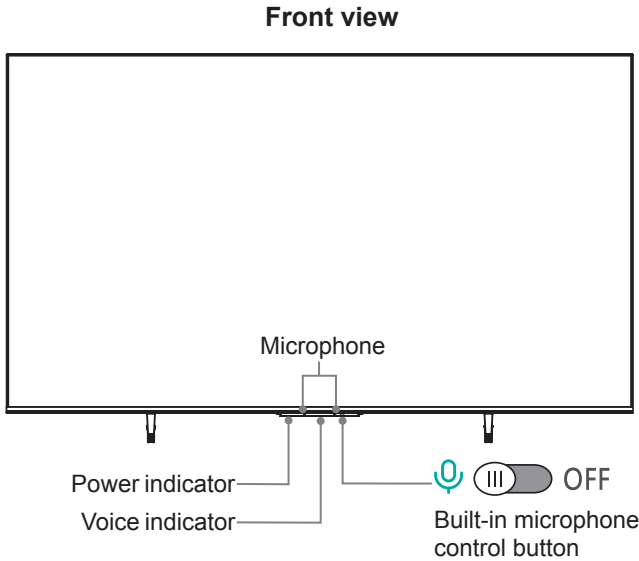
Control on the TV



The Google Assistant can answer your questions or help you change TV configuration. Before using this function, connect the TV to the Internet and sign in your Google account. When you turn on the TV for the first time, you can select **Set up Google TV** to sign into a Google Account by the setup guide, if you select **Set up basic TV**, you can also set it later by pressing to select **Set up Google TV**.

- How to use the Google Assistant function via the control button on your TV:
 1. Switch the button to [] to turn on built-in microphone.
 2. Pair the remote first, press  button to select “Yes, I’m in”.
 3. Start a conversation by saying “Hey Google”, and the dialog bar appears at the top of the TV screen. At the same time, voice indicator illuminate.
 4. Continue speaking, such as “What’s the weather” or “volume up”.

- Screenless Mode

Talk to the Google Assistant even when the screen is off.











In Screenless Mode, the Google Assistant is always available to help even when the screen is not on. Just say “Hey Google”.

This feature will affect standby power consumption. To turn it off, go to **Settings > System > Advanced System > Screenless Mode**

NOTE: The Google Assistant and some features are available on limited country/region/language.

Get your remote ready

The following table shows the buttons on your remote control and describes what they are for.

BUTTON	DESCRIPTION
	Power on/off
	Microphone / Indicator
INPUT	Change TV input source
	Google Assistant of TV
	Accounts & Sign In or switch profile
	Access the settings (direct or through the dashboard in GTV) from any place in the system
^ / v / < / >	D-pad (up/down/left/right navigation buttons)
OK	Confirmation button
	Return to the previous place in the menu or app
	Press to display the Home screen
	Enter to Live tab in launcher/Display the Electronic Program Guide(if support)/Return to Live TV*
^ VOL v	Volume (up/down)
^ CH v	Channel (up/down)
	Press to mute or restore sound Hold to display Accessibility menu
MENU	Press to enter Menu
	Media content control function buttons
APPS	Fast access to all applications
	Enter Channels/input numbers and special function buttons
App	Quick access buttons to applications

NOTE:

- Buttons listed here are for reference only. Actual remote control may vary depending on model, country.
- * Pressing the button in different scenarios will have different responses.

Insert the batteries

1. Take off the back cover to open the battery compartment of the remote control.
2. Insert two AAA or AA (1.5Vcc) size batteries. Make sure to match the (+) and (-) ends of the batteries with the (+) and (-) ends indicated in the battery compartment.
3. Restore the battery compartment cover.

Important information about the remote and batteries

- Discard batteries in a designated disposal area. Do not throw them into a fire.
- Remove old batteries immediately to prevent them from leaking into the battery compartment.
- If you do not intend to use the remote control for a long time, then remove the batteries.
- Battery chemicals can cause a rash. If the batteries leak, clean the battery compartment with a cloth. If chemicals touch your skin then wash it immediately.
- Do not mix old and new batteries.
- Do not mix alkaline, standard (carbon-zinc) or rechargeable (NiCd, NiMH, etc.) batteries.
- Do not continue using the remote if it gets warm or hot.
- Call our Support Center immediately on the support website.

Remote control range information

- The remote control can work at a distance of up to 26 feet (792.5 cm) in front of the TV set.
- It can work at a 30 degree horizontal or vertical angle.

Pairing the remote control

1. Pair the remote to the TV after you power it on for the first time, there will be instructions on how to pair the remote.
2. If your remote fails to pair with TV, keep the remote within 10 feet (304.8 cm) from the TV, press and hold the [←] button and [🏠] button at the same time at least 3 seconds to start pairing.
3. If the remote pairs successfully, a confirmation will display on the screen. If it does not pair successfully, an unsuccessful message will display. Repeat step 2, or you can press [⚙️] button to select **Settings > Remotes & Accessories > Bluetooth On**.

NOTE:

- If an unknown error occurs with the remote, it could have been caused by interference. Try to remove what's causing the interference and pair the remote again.
- If an unknown error occurs with the remote control while the battery power is normal, you can take out the batteries and press any key for 1~2 seconds, and insert them back. The remote control can work normally.
- The remote cannot be paired to the TV while the TV is in the standby mode.

Step 4. Power on the TV

Connect your power cord to the TV and plug it into a power outlet. Your TV will display a launch screen showing the Hisense logo.

55" (139.7cm)

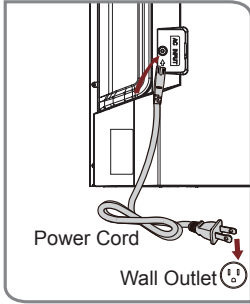

65" (165.1cm) / 75" (190.5cm)

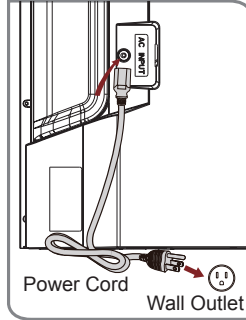

Step 5. Complete the first-time setup

The first time you turn on your TV, there is a guided setup to make it easy to connect your TV to the Internet and complete the setup of your TV.

Step 6. Establish a network connection

1. Press the [] button on the remote, and select **Settings** to enter the Settings menu.
2. Select **Network & Internet**.

Establish a wired network connection

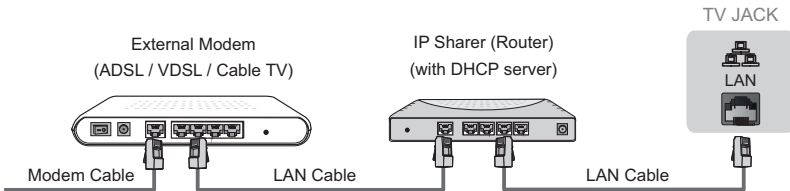

Establish a wireless network connection



And setup is done, congratulations!

Now that you've completed the first-time setup, enjoy your TV!

Text-to-Speech (TTS) and Video Description functionalities on TV

Text-to-Speech (TTS) and Video Description can help you to navigate the menus on the screen and hear an audio description of relevant programs. Text-to-Speech can convert written text into voice to help visually impaired people listen to the information they are unable to read. In addition, the Video Description has an audio narration added to certain programs that will describe the main visual elements which visually impaired users may not be able to see.

Follow the steps below to enable the functions:

1. Press the [] button on your remote to select **Settings**.
2. Next, select **System** to enter the **Accessibility** menu.
3. Select **TalkBack** to turn the Menu Audio on or off by selecting the appropriate choice that is presented.

or you can:

1. Press the [**INPUT**] button on your remote, select **TV**.
2. Next, press the menu button to select **Video Description** to turn Video Description on or off by selecting the appropriate choice that is presented.

Text-to-Speech(TTS) and Audio Description functionalities on Google TV - Hisense USA (hisense-usa.com)



Troubleshooting

If you are having trouble with your TV, first try turning it off and on again. If this does not fix the problem, check the tips in the following table. If your problem is not listed in the following table, then contact us at one of the phone numbers on page before.

Issues	Possible solutions
No sound or picture	<ul style="list-style-type: none"> • Check if the power cord is plugged into a powered AC outlet. • Press the Power button on the remote control to activate the unit from 'Standby' mode. • Check to see if the LED light is on or not. If it is, then the TV is receiving power.
I have connected an external source to my TV and I get no picture and/or sound.	<ul style="list-style-type: none"> • Check for the correct output connection on the external source and for the correct input connection on the TV. • Make sure you have made the correct selection for the input mode for the incoming signal.
When I turn on my TV, there is a delay for a few seconds before the picture appears. Is this normal?	<ul style="list-style-type: none"> • Yes, this is normal. The TV is initializing and searching for previous setting information.
The picture is normal but there is no sound	<ul style="list-style-type: none"> • Check the volume settings. • Check if 'Mute' mode is set to On.
Sound but no picture or black and white picture	<ul style="list-style-type: none"> • If the picture is black and white, unplug the TV from the AC outlet and replug it after 60 seconds. • Check that the Color is set to 50 or higher. • Try different TV channels.
The sound and/or picture is distorted or appears wavy	<ul style="list-style-type: none"> • An electric appliance may be affecting the TV. Turn off any appliances that are nearby and move it farther away from the TV. • Insert the power plug of the TV set into another power outlet.
The sound and picture is blurry or cuts out	<ul style="list-style-type: none"> • If using an external antenna, check the direction, position and connection of the antenna. • Adjust the direction of your antenna or reset or fine tune the channel.
A horizontal or vertical stripe appears on the picture and/or the picture is shaking	<ul style="list-style-type: none"> • Check if there is an appliance or electric tool nearby that is causing interference.
The plastic cabinet makes a "clicking" type of sound	<ul style="list-style-type: none"> • The 'click' sound can occur when the temperature of the television changes. This change causes the television cabinet to expand or contract, which makes the sound. This is normal and the TV is OK.
The remote control does not work	<ul style="list-style-type: none"> • Confirm that TV still has power and is operational. • Change the batteries in the remote control. • Check if the batteries are correctly installed.

Product specifications

Model Name		55U8K 55U88KM	65U8K 65U88KM
Dimension (W × H × D)	Without Stand	48.5 × 28.2 × 3.0 inches (1 233 × 716 × 75 mm)	57.2 × 33.1 × 3.0 inches (1 452 × 840 × 75 mm)
	With Stand	48.5 × 30.5 × 12.6 inches (1 233 × 774 × 320 mm)	57.2 × 35.5 × 12.6 inches (1 452 × 902 × 320 mm)
Weight	Without Stand	41.2 lbs (18.7 kg)	56.4 lbs (25.6 kg)
	With Stand	41.9 lbs (19.0 kg)	58.2 lbs (26.4 kg)
TV Stand Width(W × D)		33.4 × 12.6 inches (849 × 320 mm)	31.4 × 12.6 inches/44.3 × 12.6 inches (798 × 320 mm)/(1 126×320 mm)
Active Screen Size (Diagonal)		54.6 inches (138.7 cm)	64.5 inches (163.8 cm)
Screen Resolution		3840 × 2160	
Audio Power		2×10W + 20W + 2×5W	
Power consumption		220 W	260 W
Power Supply		100-240V~ 50/60Hz	
Connectivity		Built-in Wireless feature (2x2, three band)	
Receiving Channels		VHF: 2 - 13, UHF: 14 - 69, CATV: 1 - 125 Digital Terrestrial Broadcast (8VSB): 2 - 69 Digital cable (64/256 QAM): 1 - 135 Next-Gen TV (QPSK-4096QAM): 2-36	
Tuner Type		Frequency synthesized	
Receiving System		Analog: NTSC Digital: ATSC 1.0/Next-Gen TV/QAM on cable	
Operating Temperature		41°F - 95°F(5°C - 35°C)	
Operating Humidity		20% to 80% non-condensing	
Storage Temperature		5°F to 113°F(-15°C to 45°C)	
Storage Humidity		10% to 70%, non-condensing	

Disclaimer: All products, product specifications, and data are subject to change without notice to improve reliability, function, design or otherwise.

Product specifications

Model Name		75U8K 75U88KM
Dimension (W × H × D)	Without Stand	65.9 × 38.1 × 3.0 inches (1 675 × 968 × 76 mm)
	With Stand	65.9 × 40.7 × 14.5 inches (1 675 × 1033 × 368 mm)
Weight	Without Stand	79.4 lbs (36.0 kg)
	With Stand	81.4 lbs (36.9 kg)
TV Stand Width(W × D)		50.4 × 14.5 inches/39.7 × 14.5 inches (1 279 × 368 mm)/(1 009 × 368 mm)
Active Screen Size (Diagonal)		74.5 inches (189.3 cm)
Screen Resolution		3840 × 2160
Audio Power		2×10W + 20W + 2×5W
Power consumption		380 W
Power Supply		100-240V~ 50/60Hz
Connectivity		Built-in Wireless feature (2x2, three band)
Receiving Channels		VHF: 2 - 13, UHF: 14 - 69, CATV: 1 - 125 Digital Terrestrial Broadcast (8VSB): 2 - 69 Digital cable (64/256 QAM): 1 - 135 Next-Gen TV (QPSK-4096QAM): 2-36
Tuner Type		Frequency synthesized
Receiving System		Analog: NTSC Digital: ATSC 1.0/Next-Gen TV/QAM on cable
Operating Temperature		41°F - 95°F(5°C - 35°C)
Operating Humidity		20% to 80% non-condensing
Storage Temperature		5°F to 113°F(-15°C to 45°C)
Storage Humidity		10% to 70%, non-condensing

Disclaimer: All products, product specifications, and data are subject to change without notice to improve reliability, function, design or otherwise.

Certification and compliance

NOTE: The following warnings only apply to products with such certification.

This device complies with Part 15 of the FCC Rules. Operation is subject to the following two conditions: (1) This device may not cause harmful interference, and (2) This device must accept any interference received, including interference that may cause undesired operation.

Note: This equipment has been tested and found to comply with the limits for a Class B digital device, pursuant to Part 15 of the FCC Rules. These limits are designed to provide reasonable protection against harmful interference in a residential installation. This equipment generates, uses, and can radiate radio frequency energy and, if not installed and used in accordance with the instructions, may cause harmful interference to radio communications. However, there is no guarantee that interference will not occur in a particular installation. If this equipment does cause harmful interference to radio or television reception, which can be determined by turning the equipment off and on, the user is encouraged to try to correct the interference by one or more of the following measures:

- Reorient or relocate the receiving antenna.
- Increase the separation between the equipment and receiver.
- Connect the equipment into an outlet on a circuit different from that to which the receiver is connected.
- Consult the dealer or an experienced radio/TV technician for help.

The manufacturer is not responsible for any radio or TV interference caused by unauthorized modifications to this equipment. Such modifications could void the user's authority to operate the equipment.

This equipment complies with FCC radiation exposure limits set forth for an uncontrolled environment. This equipment should be installed and operated with minimum distance of [20] cm between the radiator and your body. This transmitter must not be co-located or operating in conjunction with any other antenna or transmitter.

This device contains licence-exempt transmitter(s)/receiver(s) that comply with Innovation, Science and Economic Development Canada's licence-exempt RSS(s). Operation is subject to the following two conditions:

- (1) This device may not cause interference.
- (2) This device must accept any interference, including interference that may cause undesired operation of the device.

This equipment complies with radio frequency exposure limits set forth by the Innovation, Science and Economic Development Canada for an uncontrolled environment. This equipment should be installed and operated with a minimum distance of 20 cm between the device and the user or bystanders.

This device must not be co-located or operating in conjunction with any other antenna or transmitter.

Declaration of conformity

Trade Name: Hisense

Model: 55U8K / 55U88KM / 65U8K / 65U88KM / 75U8K / 75U88KM

Responsible Party: Hisense USA Corporation

Service Address: 105 Satellite BLVD Suite I, Suwanee, GA 30024

Service Phone Number: 1-888-935-8880



Dolby, Dolby Vision, Dolby Atmos, and the double-D symbol are registered trademarks of Dolby Laboratories Licensing Corporation. Dolby Vision IQ is a trademark of Dolby Laboratories Licensing Corporation. Manufactured under license from Dolby Laboratories. Confidential unpublished works. Copyright © 2012-2022 Dolby Laboratories. All rights reserved.



The terms HDMI and HDMI High-Definition Multimedia Interface, and the HDMI Logo are trademarks or registered trademarks of HDMI Licensing Administrator, Inc. in the United States and other countries.



For DTS patents, see <http://patents.dts.com>. Manufactured under license from DTS Licensing Limited. DTS, DTS:X, Virtual:X, and the DTS:X logo are registered trademarks or trademarks of DTS, Inc. in the United States and other countries. © 2021 DTS, Inc. ALL RIGHTS RESERVED.



Manufactured under license from IMAX Corporation. IMAX® is a registered trademark of IMAX Corporation in the United States and/or other countries. For DTS patents, see <http://patents.dts.com>. Manufactured under license from DTS Licensing Limited. DTS and the DTS logo are registered trademarks or trademarks of DTS, Inc. in the United States and other countries. © 2020 DTS, Inc. ALL RIGHTS RESERVED.



Environmental protection

This mark indicates that this product should not be disposed together with other domestic garbage, to avoid damage to the environment or human health due to the disposal of uncontrolled waste. Recycle it responsibly for promoting the sustainable reuse of material resources. To return your used device, please use the return systems available in your location or contact the vendor where you purchased your product they could take this product for recycling and protection of the environment.

©2023. All rights reserved. Hisense and the Hisense logo are registered trademarks of Hisense. Other brand and product names are registered trademarks of their respective owners.