



USER MANUAL

Before using the TV, please read this manual thoroughly and retain it for future reference.

ENGLISH

FRANÇAIS

ESPAÑOL

Hisense

USER MANUAL

Before using the TV, please read this manual thoroughly and retain it for future reference.

ENGLISH

Copyright Statement

© 2021 Hisense Company Ltd. All Rights Reserved.

All material in this User Manual is the property of Hisense Company Ltd. and its subsidiaries, and is protected under US, CANADA, MEXICO and International copyright and/or other intellectual property laws. Reproduction or transmission of the materials, in whole or in part, in any manner, electronic, print, or otherwise, without the prior written consent of Hisense Company Ltd. is a violation of Hisense Company Ltd. rights under the aforementioned laws.

No part of this publication may be stored, reproduced, transmitted or distributed, in whole or in part, in any manner, electronic or otherwise, whether or not for a charge or other or no consideration, without the prior written permission of Hisense Company Ltd.

Requests for permission to store, reproduce, transmit or distribute materials may be made to one of the following addresses:

USA: Hisense USA Corporation
7310 McGinnis Ferry Road
Suwanee, GA 30024

CANADA: Hisense Canada Co., Ltd
2283 Argentia Road, Unit 16
Mississauga, ON, Canada
L5N 5Z2

MEXICO

IMPORTER:

Hisense Mexico S. de R.L. de C.V.
Blvd. Miguel de Cervantes Saavedra No 301
Torre Norte Piso 2, Col. Ampliación Granada
Miguel Hidalgo, Ciudad de México, C.P. 11520
RFC: HME110512IY3
TEL: (52) (55) 5531-3515

Hisense, and any and all other Hisense product names, logo's, slogans or marks are registered trademarks of Hisense Company Ltd. and its subsidiaries. All other trademarks are the property of their respective holders.

©2021. All rights reserved. Hisense and the Hisense logo are registered trademarks of Hisense. Other brand and product names are registered trademarks of their respective owners.

Disclaimer Page

**Notwithstanding anything to the contrary, including in any or all descriptions, representations, statements or other communications related to this Hisense device (hereinafter "Device") made in any form whatsoever and at any time, some or all of the pre-installed, or subsequently installed Application Services may not be available or capable of functioning as intended by the provider of the Application Services in any or all usage areas for reasons outside of Hisense's control, including but not limited to, Internet access, local service limitations, etc. Any purchase or use of the Device, including any Application Services, is purely at the user's risk. Application Services are provided on an as-available basis without warranties of any kind, either expressed or implied, that the Application Service will be uninterrupted or error-free, including but not limited to vagaries of weather, disruption of Service, acts of God, warranties of title, local or regional limitations, no infringement, NOR IMPLIED WARRANTIES OF MERCHANTABILITY OR FITNESS FOR A PARTICULAR PURPOSE. No advice or information given by Hisense, providers, affiliates, or contractors or their respective employees shall create such a warranty. Hisense specifically disclaims responsibility for any or all Application Services from functioning at any time, and by purchasing the Device, you accept such disclaimer without any claim on Hisense. You are solely responsible for providing an active and working connection to the Internet, along with any and all hardware and/or software necessary to use the Hisense Device as intended.

Disclaimer:

Images throughout this document are for illustrative purposes only and may differ from the actual product.

Contents

First-Time Use

| | |
|---------------------------------|---|
| Using the E-Manual..... | 3 |
| Home Screen..... | 3 |
| Connecting to the Internet..... | 3 |
| Prepare Live TV..... | 5 |
| Using External Devices..... | 5 |
| Recommended Topics..... | 6 |

Enjoy Live TV

| | |
|---|----|
| Channel Scan..... | 7 |
| Live Menu..... | 7 |
| Channel Edit..... | 8 |
| Learn about Live TV Support Settings..... | 11 |

Benefits of Smart TV

| | |
|------------------------------------|----|
| Using a Google Account..... | 13 |
| Using Voice Control..... | 13 |
| Content Sharing..... | 15 |
| Using Apps..... | 16 |
| Apps Settings and Permissions..... | 17 |
| Enhanced Viewing..... | 18 |
| Using the Mobile App..... | 18 |

Connecting to External Devices

| | |
|---|----|
| Remote & Accessories..... | 20 |
| Connecting Bluetooth Devices..... | 21 |
| Sharing your Smart Phone/Computer Screen on the TV..... | 22 |
| Connecting USB Devices..... | 23 |
| Connecting Headphones..... | 23 |
| Connecting Audio Visual (AV) Devices..... | 24 |
| Connecting Speakers or Other Audio Receivers..... | 25 |
| Connecting a Digital Audio System with ARC..... | 25 |
| Connecting a PC..... | 26 |

Settings Overview

| | |
|-----------------------------|----|
| Picture..... | 27 |
| Sound..... | 31 |
| Network & Internet..... | 35 |
| General..... | 35 |
| Support..... | 38 |
| Using Parental Control..... | 40 |

Contents

| | |
|--|----|
| Reset to Factory Default..... | 40 |
| Entertainment | |
| Game..... | 41 |
| SoundBar Settings..... | 42 |
| Sports..... | 42 |
| Media..... | 42 |
| Accessibility Features | |
| Accessibility Menu Setup..... | 47 |
| Troubleshooting | |
| FAQ..... | 48 |
| Remote Control Service..... | 55 |
| Picture Issues..... | 55 |
| Sound Issues..... | 56 |
| Network Issues..... | 57 |
| Channel and Broadcast Issues..... | 57 |
| External Device Connection Issues..... | 57 |
| HDMI & CEC Issues..... | 58 |
| Application Issues..... | 58 |
| Media Files..... | 59 |
| Voice Service Issues..... | 59 |
| Other Issues..... | 59 |

Using the E-Manual

View the embedded E-Manual that contains information about your TV's key features.

Disclaimer:

Instructions and images through this manual are only for reference and may differ from the actual product.

Launch the E-Manual

Press  button on your remote control to select **Settings > System > Advanced System > E-Manual**.

Scan the QR Code with your Smart Phone to open the E-Manual on your device.

Note:

- The black background icon stands for the button on the remote control.
- The grey background icon stands for the icons on the TV screen for selecting.

Use the Buttons in the E-Manual

Search

You can use  icon on the top of the E-Manual to search for the product feature information, and the E-Manual will provide all the titles and content that contains the search information.

Setting

You can use  icon on the top of the E-Manual home screen to adjust the text size.

Home Screen

All TV functions can be accessed from the Home screen.

Display the Home Screen

Press  button on your remote control to enter the Home screen.

To exit the Home screen, use your remote control or use the navigation buttons on the screen to move the cursor to other icons, press  button to enter and select your desired service.

Connecting to the Internet

To get access to the Internet using a wired connection or connecting to an available wireless network.

Connect to a Wired (Ethernet) Network

To get access to the Internet using a wired connection, it is recommended to use a modem or router that supports Dynamic Host Configuration Protocol (DHCP). Modems and routers that support DHCP automatically provide the IP address, subnet mask, gateway, and DNS, so you do not have to enter them manually. Most home networks already have DHCP.

See the illustration below.

First-Time Use

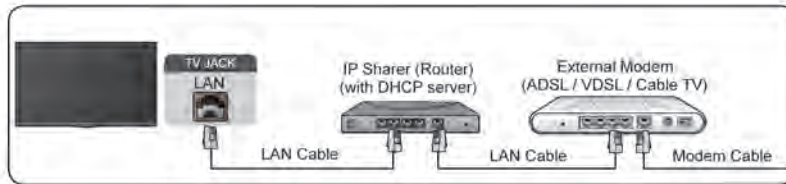

After connecting to a wired (Ethernet) network:

Press **⚙️** button on your remote control to select **Settings > Network & Internet**.

Go to ETHERNET section, and set the TV network by pressing **OK** button to enter the submenu.

- **Connection Type**

Show whether the Ethernet is connected.

- **Proxy settings**

You can set the proxy server.

- **IP settings**

Configure the IP setting for your network connection.

Related information

[Network & Internet](#) on page 35

[Network Issues](#) on page 57

[My TV cannot connect to the network.](#) on page 50

Connect to a Wireless Network

To connect to an available wireless network, make sure that you turn on your wireless router and have the wireless router's SSID and password before attempting to connect.

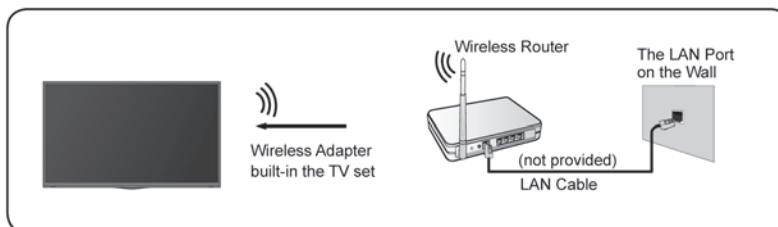

To get access to the Internet using a wireless connection:

Press **⚙️** button on your remote control to select **Settings > Network & Internet > Wi-Fi**.

To get access to the Internet in a wireless way:

1. Turn on your **Wi-Fi**.
2. The list of networks will display automatically.
3. Select a wireless network from the list, and input the password.
4. If the network connection does not appear in the list, select **See all** to display all the list, or select **Add new network** to input a wireless network name, select the type of security mode, and enter password.

First-Time Use

Related information

[Network & Internet](#) on page 35

[Network Issues](#) on page 57

[My TV cannot connect to the network.](#) on page 50

Internet Related Features

- Content Sharing

To view media content, like videos, music or photos saved in your Android/iOS/PC device on your TV screen. For more information, please refer to [Benefits of Smart TV > Content Sharing](#) in this manual.

- Sharing your Smart Phone/Computer Screen on the TV

To mirror your mobile device or computer screen to the TV. For more information, please refer to [Connecting to External Devices > Sharing your Smart Phone/Computer Screen on the TV](#) in this manual.

Prepare Live TV

Connect antenna/cable to the TV

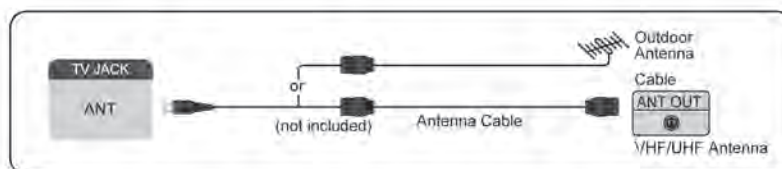

Note:

- TV jacks may vary and antenna/cable function may not be applicable in some models/countries/regions.
- You may also connect devices that can receive broadcast signals such as a Set Top Box.

Start auto scan or manual scan

1. **INPUT** > TV
2. Press **+** button on your remote control to select **Settings > Channels & Inputs > Channels > Auto Channel Scan/Manual Scan**.

Related information

[Channel Scan](#) on page 7



Using External Devices

Switch between external devices connected to the TV

1. Press **INPUT** button on your remote control or use the navigation buttons to move the cursor to the **Inputs** icon on the Home screen, press **OK** button to enter.
2. Select your desired input source.

First-Time Use

Edit the name of input sources

1. Press  button on your remote control or press  button to move the cursor to the  **Inputs** icon on the Home screen, press  button to enter.
2. Press  button to rename input.

Note:

- Maximum name length is 36 characters.

Recommended Topics

Install an App

Install apps from App Store for your entertainment preferences. For more information, please refer to [Benefits of Smart TV > Using Apps > Install an App](#) in this manual.

Picture

Adjust picture mode, picture size and other advanced picture settings. For more information, please refer to [Settings Overview > Picture](#) in this manual.

Sound

Adjust sound mode and other advanced sound settings. For more information, please refer to [Settings Overview > Sound](#) in this manual.

Keep the TV updated

Set your TV to receive the latest firmware. For more information, please refer to [Settings Overview > Support > System Update](#) in this manual.

Enjoy Live TV

Channel Scan

You can scan for channels automatically or manually.

Note:

Antenna/cable function may not be applicable in some models/countries/regions.

Auto Channel Scan

Automatically scan for channels to view programs from your TV source.

 > TV

If no TV channels were saved before, you will be prompted to do a channel search.

In Live TV,  > **Channels** > **Auto Channel Scan**

Before you select Auto Channel Scan, you can press  > **Channels** > **Tuner Mode** to select **Antenna** or **Cable**.

Manual Scan

In Live TV,  > **Channels** > **Manual Scan**

Type in a channel to add it manually to your TV.

Live Menu

You can obtain quick access to the channel list, favorite channel list or use relevant features with ease when watching TV programs.

Display Channel List

In Live TV, press  button on the remote control to display the Channel List menu.

Learn about channel list sub-menu.

In Live TV,  > 

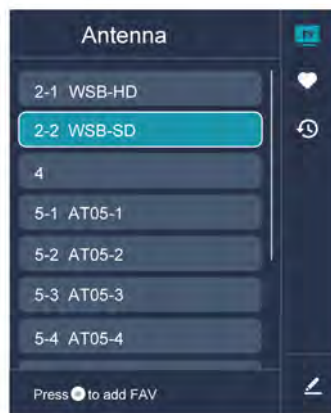

Enjoy Live TV

TV List

Display Live TV channel categories, such as **Cable** and **Antenna**.

Fav

Display favorite lists.

History

Display the channels that have been watched for a period of time.

Edit

Edit the channel list.

Note:

- The sub-menu options may vary depending on models/countries/regions.

Related information

[Edit Channel List](#) on page 8

Display Favorite Channel List

In Live TV, press **OK** > **▶** > **▼** to select **FAV**, and press **OK** button to display the favorite list.



Note:

- These steps should be operated under TV inputs.

Related information

[Edit Favorite Channel List](#) on page 10

Channel Edit

Manually edit the channel list or favorite channel list to your preference.

Edit Channel List

Before you can edit the channel list, Channel Scan must be completed first.

Enjoy Live TV



Manage the Channels

In Live TV, press **OK** > **▶** to select a Live TV channel category such as Antenna or Cable, then use D-pad to select **Edit**.

- Delete:
 1. Select the channel you want to delete, or press **OK** to select more channels.
 2. Press **▶** button to delete.
- Restore: Press **123** button to display the colour menu and select RED to enter the list of deleted channels. Press **◀** button to restore the deleted channel.



Enjoy Live TV



Edit Favorite Channel List

Before you can edit the favorite list, Channel Scan must be completed first.

Add a channel to a favorite list

You can add channels from various reception types to the favorite list.

1. In Live TV, press **OK** button to display the channel list.
2. Press **Menu** button, select the channel(s) you want to add to the favorite list by pressing **OK** button.
3. Press **Left** button to select **Add to Favorite**.
4. press **OK** button to confirm.
5. Then, a heart-shape icon will appear next to the added channel.



Move or remove channels in a favorite list

If you want to remove favorite channels:

1. In Live TV, press **OK** > **Right** > **Down** to select **FAV**, and press **OK** button to display the favorite list.
2. Press **Menu**, select the channel(s) you want to delete to the favorite list by pressing **OK** button.
3. Press **Left** button to select **Delete Fav. Channel**.

Enjoy Live TV

4. Then a heart-shaped icon will disappear on FAV list.



Note:

- These steps should be operated under TV inputs.
- Before you edit the favorite lists, complete channel scan first.

Related information

[Channel Scan](#) on page 7

Learn about Live TV Support Settings

You can set audio language or default audio output language, etc.

Audio Language (MTS)

You can choose the audio language in DTV mode and you can set MTS for **Mono**, **Stereo** or **SAP** in ATV mode.

Press button on your remote control to select **Settings > Channels & Inputs > Channels > Audio Language (MTS)**

Primary Audio/Secondary Audio

- **Primary Audio**

Set the default audio output language for the type of digital broadcast content that you are viewing.

- **Secondary Audio**

Set the secondary audio output language for digital broadcast content.

Note:

- If your selected Primary Audio and Secondary Audio are included in the MTS list, the MTS list defaults to Primary Audio and Secondary Audio settings after you switch channel or turn on/off the TV.

Video Description

Enables broadcasted descriptive audio for visually impaired.

Enjoy Live TV

Press  button on your remote control to select **Settings > Channels & Inputs > Channels > Video Description**.

Related information

[Accessibility Menu Setup](#) on page 47

Benefits of Smart TV

Using a Google Account

Sign in with Google to get apps, Google Assistant, and personalized recommendations.

Signing into an account

When you turn on the TV for the first time, you can select **Set up Google TV** to sign into a Google Account by the setup guide, if you select **Set up basic TV**, you can also set it later by pressing  to select **Set up Google TV**.

- Set up with the Google Home app
- Set up on TV instead

Before signing into your Google account, make sure your TV is connected to the network. For more about network settings, please refer to [Connect to the Internet > Connect to a Wired \(Ethernet\) Network](#) or [Connect to a Wireless Network](#) in this manual, after the network is connected, enter your E-mail/phone and password, select **Sign In**.

Adding a kid account



You can create a personalized space for your kid with access to content they love and tools to help keep you in control.

1. After the network is connected,  > **Settings > Accounts & Sign-in > Add a kid**
2. Set up Google TV for a kid in your family, you can do the same for more kids later.

Adding another account

You can use other accounts within Google apps like YouTube, but you won't see recommendations for those accounts on the Google TV home screen.

Before creating a new account, make sure your TV is connected to the network. For more about network settings, please refer to [Connect to the Internet > Connect to a Wired \(Ethernet\) Network](#) or [Connect to a Wireless Network](#) in this manual.

1. After the network is connected,  > **Settings > Accounts & Sign-in > Add another account**
2. Enter E-mail/phone and password.
3. Press .

Using Voice Control

Set up voice assistant to control your TV just by your voice.

Google Voice Setup

Voice Control may not be applicable in some models/countries/regions.

Google Assistant

You can ask for information, search for your favorite movies, control your TV and more, just by asking Google Assistant.

Before setting up Google Assistant, connect your TV to the network.

Benefits of Smart TV

How to start Google Assistant

You can choose this way to start Google Assistant:

- Press  button on your remote control.

Note:

- The Google Assistant function may not be applicable in some models/countries/regions.
- The setup steps above may vary depending on actual products.

Hands-free Voice Control

Google Assistant can answer your questions or help you change TV configuration.

Before using this function, connect the TV to the Internet and sign in your Google account, by pressing , select **Settings > Accounts & SignIn**

Note:

- Hands-free Voice Control may not be applicable in some models/countries/regions.

How to set up Hands-free Voice Control

1. Switch the control button on the bottom of the TV to  to turn on Google Assistant.
2. Start a conversation by saying "Hey Google", and the dialog bar appears at the top of the TV screen. At the same time, indicator lights illuminate.
3. Continue speaking, such as "What's the weather" or "volume up".

Screenless mode

 > **Settings > Advanced System > Screenless Mode**

Talk to Google Assistant when the screen is off.

In Screenless Mode, Google Assistant is always available to help even when the screen is not on. Just say "Hey Google".

This feature will affect standby power consumption. To turn it off, press  button, select **Settings > Advanced System > Screenless Mode**

Note:

- Google Assistant and some features are available on limited country/region/language.
- Screenless mode is only for models with far-field Google Assistant.

Alexa Setup

Set up to control your TV with any Alexa-enabled devices. Alexa can help you change the TV configuration. Using just your voice, you can change inputs, volume, channels, and more. Just ask Alexa.

What is required to control your TV with Amazon Alexa?

- Android TV models that support the Alexa skill.
- Amazon Echo device or Alexa App.
- Amazon account for Alexa App or Echo device, if you don't have the account, please create one before the setup process.
- Hisense account to link your TV, you can create it before the setup process or in the period.

Benefits of Smart TV

- Home network with Wi-Fi capabilities.
- For issues of accessing your Amazon account and using the Alexa app during setup, please visit amazon.com for help.

How to set up Alexa

1. Press , select **Settings > System > Advanced System > Amazon Alexa Service**
2. Select **Set up now**.
3. Link the TV to Hisense account. Scan the QR code with your phone, or visit the website on your phone or computer, sign in your Hisense account, and enter the code showed on the TV. The webpage and code will be expired after 15 minutes.
4. Next, your TV screen shows a list of TV name. Select one from it or enter a custom name. Then, your TV will appear in the device name list on your phone or computer.
5. Download the Alexa app on your smart phone. Open the app and sign in with your Amazon account.
6. In the Alexa app, select Skills section, search and enable Hisense Smart TV skill. Follow the instructions to link your Amazon account by entering the same Hisense account that you've signed on your TV.
7. On your TV, select **Skill enabled** and **Done**.
8. Now, You can ask Alexa try some functions available for TV.

Note:

- Use external Alexa-enabled devices (e.g. Alexa App, Echo) to control your smart TV by using just your voice.
- After your Hisense account is created but you can't see the Link your TV step on your phone or computer, please sign out account and re-visit URL and sign in again.
- If you do not see "Amazon Alexa Service" in the System settings, then your TV does not support Alexa.
- The Alexa function may not be applicable in some models/countries/regions.
- The setup steps above may vary depending on actual products.

Voice Service Other Issues

If you want to turn on your TV with Alexa-enabled devices (e.g. Echo, Echo show) or Google Home devices (e.g. Google Home, Google Nest Hub), please:

1. Turn on **Screenless Mode** at  > **Settings > System > Advanced System**
2. Make sure your TV and Alexa-enabled devices/Google Home devices are connected to the same network environment.

Note:

- Only Alexa (Alexa skill is enabled) and Google Smart Home Service support turning on your TV with Alexa Echo or Google Home.

Related information

[Connect to a Wired \(Ethernet\) Network](#) on page 3

[Connect to a Wireless Network](#) on page 4

Content Sharing

Content Sharing allows you to view media content, like videos, music or photos saved in your Android/iOS/PC device on your TV screen.

Benefits of Smart TV

Share Media Content from your Device

1. Connect your TV and Android/iOS/PC device to the same network.
2. Turn on Content Sharing at **⚙️ > Settings > System > Advanced System > Content Sharing**
3. Turn on the content sharing function in your Android/iOS/PC device.
4. Find the TV name in the search list of your device and select it. Wait for the connection progress to complete.
5. On your Android/iOS/PC device, choose the media content you want to share on your TV.

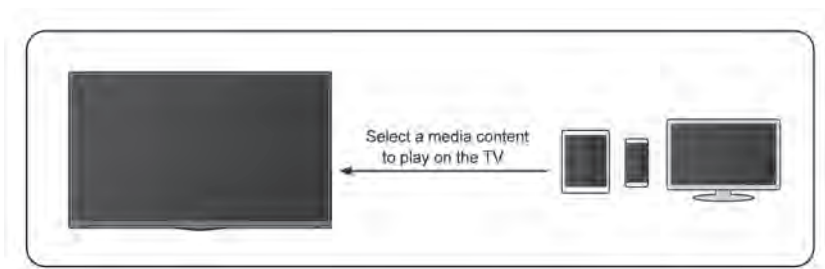

Related information

[Connect to a Wired \(Ethernet\) Network](#) on page 3

[Connect to a Wireless Network](#) on page 4

Play Media Content from your Device on the TV

You can connect media content saved in your Android/iOS/PC device to your local network and play the content on your TV.

1. Connect your TV and Android/iOS/PC device to the same network.
2. Turn on Content Sharing at **⚙️ > Settings > System > Advanced System > Content Sharing**
3. Make sure your media content in your Android/iOS/PC device are visible through the local network.
4. On your TV, select a device with media content at **⚙️ > Settings > Apps > MediaCenter**, or **🏠 > Your Apps > MediaCenter**. The media content list in your Android/iOS/PC device appears.
5. Select a media content item from the list to play.

Note:

- Some Android/iOS/PC devices may not support content sharing function. If your device does not support content sharing, you can download an app that supports the function to connect to your TV. For more information, please refer to [Benefits of Smart TV > Using the Mobile App](#) in this manual.
- Content may not be played depending on the file format.
- Content may not be played smoothly, or the function may not work properly due to the network condition.

Using Apps

🏠 > Apps

From the Apps screen, there are many recommended apps for you, you can find your favorites and use them very easily.

You can find popular apps by App categories, other devices, etc.

Numerous factory-installed apps are available for you to choose for your entertainment preferences.

Benefits of Smart TV

Install an App

Even though your TV has numerous factory-installed apps, there may be others that you would like to download.

To install an app:

1. From the Apps screen, you can use the search box to search for your apps and games that you want to install.
2. Select the **Install**. The selected app is installed on the TV.

Note:

- To use this function, your TV must be connected to the Internet.
- Adding apps is free, but it might cost you money when using some apps.

Manage Apps

To move an app:

1. From the Apps screen, use the navigation buttons on your remote control to select the app that you want to move. Long press **OK** button.
2. Select **Move**.
3. Use the navigation buttons on your remote control to move the location of the app. Press **OK** button to confirm.
4. Press **←** button to finish.

Remove an App

You can only delete apps that you've installed to the TV. Factory-installed apps can not be deleted.

To delete an app:

1. From the Apps screen, use the D-pad on your remote control to select the app that you want to remove. Long press **OK** button, select **view details**.
2. Select **Uninstall**.
3. A dialog message displays that asks "Do you want to uninstall this app for all users?". Confirm **OK** and the app will be removed from all users on the device.

Note:

- If you didn't find the app on home page, you want to remove, you can press **⊕** > **Settings** > **Apps** > **See all apps**

Apps Settings and Permissions

You can find all the apps on the TV at **⊕** > **Settings** > **Apps** > **See all apps**.

Select the app, you can see the app's **Version**, **Storage used**, or you can **Open**, **Uninstall/Force stop**, **Uninstall updates**, **Disable**, etc.

Clear data

⊕ > **Settings** > **Apps**, select the app, then select **Clear data**

Benefits of Smart TV

All this app's data will be deleted permanently. This includes all files, settings, accounts, databases, etc.

Clear cache

Clear cache of applications and system.

Clear defaults

Clear defaults for apps.

Permissions

You can turn on or off the Location, and if you turn on **Remove permissions** if app isn't used, you can protect your data, permissions for this app will be removed if the app is unused for a few months.

Enhanced Viewing

Press  button on your remote control to select **Settings > System > Advanced System > Enhanced Viewing**

You can turn on Enhanced Viewing features to enhance viewing experience.

Automatic Content Recognition

Provide picture quality and audio quality adjustment for the current content.

Note:

- This function may not be applicable in some models/countries/regions.
- To use this function, you should accept End User License Agreement and smart feature privacy policy/terms and conditions and choose **Yes, Enable Enhanced Viewing** in the setting process.

You will see the other Enhanced Viewing settings change from a greyed out state to highlighted. When this occurs, **Picture Mode Auto Adaptation** and **Sound Mode Auto Adaptation** features will be enabled.

Picture Mode Auto Adaptation

Automatically switch to the best picture mode for the current content.

Note:

- This function may not be applicable in some models/countries/regions.

Sound Mode Auto Adaptation

Automatically switch to the best sound mode for the current content.

Note:

- This function may not be applicable in some models/countries/regions.

Using the Mobile App

Press  button on your remote control to select **Settings > System > Advanced System > Mobile App Installation**

Benefits of Smart TV

You can scan the Mobile App download QR code on screen to install the app on your smartphone to control your TV. It is a convenient and easy way to control your TV. This app is available on both Android and iOS.

To connect your TV after installing the mobile app:

1. Make sure your mobile phone and TV are connected in the same network environment.
2. To use this function, switch on Content Sharing at  **Settings > System > Advanced System > Content Sharing**.
3. Open the mobile app and select the TV device you want to connect.

What you can do with the app:

- Turn the TV on or off
- Volume up or down
- Switch channels
- Input characters with your mobile's keyboard
- Share pictures, music, or videos from your mobile device to the TV

Note:

- This function may not be applicable in some models/countries/regions.

Related information

[Connect to a Wired \(ETHERNET\) Network](#) on page 3

[Connect to a Wireless Network](#) on page 3



Connecting to External Devices

Remote & Accessories

Connect remote controls or other accessories, such as keyboard, mouse and gamepad, to interact with your Smart TV easily.

Connect Remote Control

Pair the Bluetooth remote control with the TV.

1. To pair the Bluetooth remote control to the TV after you power the TV on for the first time, there will be instructions on how to pair the remote control.
2. If your remote control fails to pair with TV, keep the remote control within 10 feet (304.8 cm) from the TV, hold  and  at the same time at least 3 seconds to start pairing until you see the light pulsing on the remote control.

Note:

- If your remote control fails to pair with TV, check the **Bluetooth** is set **On** by pressing  button to select **Settings > Remotes & Accessories > Bluetooth to On**.
- This function may not be applicable in some models/countries/regions.
- If an error occurred while trying to pair the remote control, it could have been caused by interference. Try to remove what is causing the interference and try pairing again.
- If an error occurred with the remote control while using sufficiently charged batteries, you can take out the batteries for 1~2 seconds then insert them back again. Now the remote control will work normally.
- The remote control cannot be paired to the TV while the TV is in standby mode.

Use HDMI&CEC

Use the TV's remote to control external devices that are connected to the TV by an HDMI cable. The external devices need to support HDMI&CEC function.

Connecting an external device through HDMI&CEC function

Press  button to select **Settings > Channels & Inputs > Inputs > HDMI control**.

1. Set **HDMI control** to On.
2. Connect an HDMI&CEC compliant device to the TV.
3. Turn on the connected external device. The device is automatically connected to the TV. After connection is finished, you can access the menu of the connected device on your TV screen using your TV remote control and control the device.

Enabling device auto power off

Press  button to select **Settings > Channels & Inputs > Inputs > Device auto power off**

Set to On to turn off CEC compatible external devices when the TV is turned off.

Enabling TV auto power on

Press  button to select **Settings > Channels & Inputs > Inputs > TV auto power on**.

Set to On to turn on the TV when CEC compatible external devices is turned on.

Note:

Connecting to External Devices

- HDMI cables must be used to connect HDMI&CEC compatible devices to your TV.
- The HDMI&CEC feature of the connected device must be turned on.
- If you connect an HDMI device that is not HDMI&CEC compatible, all the HDMI&CEC control features do not work.
- Depending on the connected HDMI device, the HDMI&CEC control feature may not work.
- The HDMI&CEC feature are supported One Touch Play, Routing Control, System Standby, Device OSD Name Transfer, Remote Control Pass Through, Give Device Power Status, System Audio Control.

HDMI format function

In HDMI source, press  button to select **HDMI Format**.

Please select **Enhanced format** if your HDMI device supports 4K HDR. If it does not support 4K HDR, please select **Standard format**.

Note:

- HDMI cables must be used to connect HDMI & CEC compatible devices to your TV.
- The HDMI & CEC feature of the connected device must be turned on.
- If you connect an HDMI device that is not HDMI & CEC compatible, all the HDMI & CEC control features do not work.
- Depending on the connected HDMI device, the HDMI & CEC control feature may not work.
- The HDMI & CEC feature supports One Touch Play, Routing Control, System Standby, Device OSD Name Transfer, Remote Control Pass Through, Give Device Power Status, System Audio Control.

Related information

[HDMI & CEC Issues](#) on page 58

Control the TV with a Keyboard, Mouse or Gamepad

Connect a keyboard, mouse or gamepad to control your TV easily.

Connect a USB keyboard, mouse or gamepad

Plug the keyboard, mouse or gamepad cable into the USB port of your TV.

Connect a Bluetooth keyboard, mouse or gamepad

Find the Bluetooth device name in **Settings > Remotes & Accessories** and select it.

Note:

- Keyboard, mouse, or gamepad connected via USB or Bluetooth technology may not be usable with some Apps.
- Bluetooth function may not be supported depending on the models/countries/regions.
- For more information about how to connect a Bluetooth device, refer to the Bluetooth device's user manual.

Related information

[Connect a Bluetooth Device](#) on page 22

Connecting Bluetooth Devices

You can connect to devices using Bluetooth technology.

Connecting to External Devices

Turn on Bluetooth Feature on your TV

Press  button to select **Remotes & Accessories > Bluetooth to On.**

Connecting a Bluetooth device

To pair a Bluetooth device, such as Bluetooth headphones, speakers, keyboards, mouse or even mobile devices:

1. Before pairing your Bluetooth devices, make sure they're in pairing mode and put devices within range of the TV. To put your Bluetooth devices in pairing mode, refer to the user manual of devices.
2. Press  button to select **Remotes & Accessories > Pair accessory** to put the TV in pairing mode. A list of available Bluetooth devices will be displayed.
3. Select the desired device from the list, then follow the onscreen instructions. If you are prompted to enter a passcode, refer to the user manual of the device. After pairing is completed, the device is connected and is stored to the TV.

Note:

- You need to unpair a paired device first if the maximum number of paired devices was reached.

Note:

- One Bluetooth speaker or Bluetooth headphone can be connected to the TV all the time, also you can select HeadPhone Only.
- Some compatibility issues may occur depending on the Bluetooth device support.
- Bluetooth keyboards may not be functional with some applications.
- The TV and Bluetooth devices may become disconnected if the distance between them is too long.
- This function may not be applicable in some models/countries/regions.

Related information

[Headphone Settings Setup](#)

Listen to the Audio through Bluetooth Devices

1. Pair the Bluetooth audio devices using the TV's Bluetooth function. Refer to the user manual of your audio device such as Bluetooth speaker, sound bar and headphones for detailed connection steps and usage.
2. Press  button on your remote control to select **Settings > Display & Sound > Sound > Audio Output**, and then select the **Bluetooth** option to listen to the audio through bluetooth devices.

Note:

- Compatibility issues may occur depending on the Bluetooth device.
- The TV and Bluetooth devices may become disconnected if the distance between them is too long.
- This function may not be applicable in some models/countries/regions.

Sharing your Smart Phone/Computer Screen on the TV

Mirror content from your mobile device to the TV. View videos, photos and more from your device on your TV screen.

Press  button to select **Apps**, and select **Screen Sharing** or  > **Settings > Apps > Screen Sharing**

1. Connect your mobile device to the WLAN network.

Connecting to External Devices

2. Turn on the casting function of your Android/Windows10 device. The function name and location will be different according to your device. The feature may be called "Wireless display", "Smart view", "Wireless projection", etc.
3. Find the TV name in the searching list of your device and select it to connect to your TV. Your mobile device's screen will be mirrored once you select your TV. If you are using Wi-Fi, the connecting may fail and the screen won't switch. You can close Screen sharing application with BACK or EXIT button.

Note:

- Some mobile devices may not support casting feature.

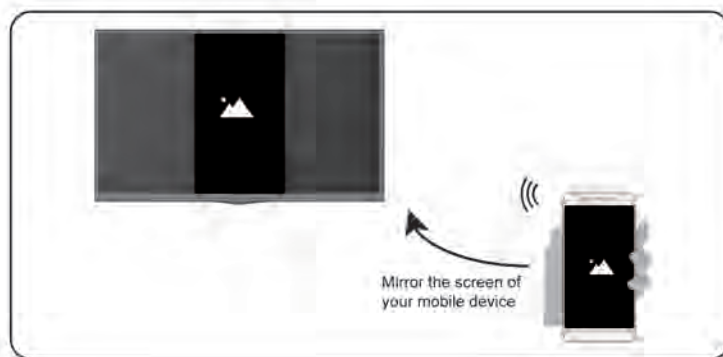

[Connect to a Wireless Network](#)

Connecting USB Devices

Connect the USB devices such as hard drives, USB sticks and digital cameras for browsing photos, listening to music.



- Support the USB disk 4G, 8G, 16G, 32G, 64G, 128G and other common market size, and 8T hard drive is currently supported.
- Support format: NTFS, FAT32.
- Certain digital cameras may not be compatible with the TV.

Select the content you want to play or view. For more information, please refer to [Entertainment > Media](#) in this manual.

Connecting Headphones

You can connect a pair of headphones (not provided) to the HEADPHONE port on your TV. While the headphone is connected, the sound from the built-in speakers will be disabled.

Connecting to External Devices

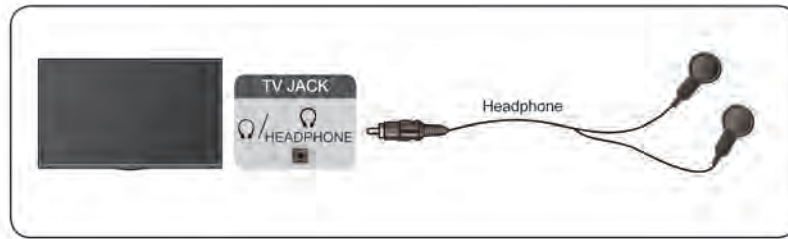

Note:

- Headphone port may not be available in some models.
- Headphones with microphones are not supported.
- If **Headphone with Speakers** is selected in **Settings > Display & Sound > Sound > Advanced Settings > Headphone Mode**, the headphone and the TV will have sound output at the same time.

Related information

[Headphone Settings Setup](#)

Connecting Audio Visual (AV) Devices

Connect with a composite video cable

To connect an AV device with a composite video cable (not provided), see the illustration below.

When the connection is completed, using your remote control, press **INPUT** button and select **AV** as the input source.

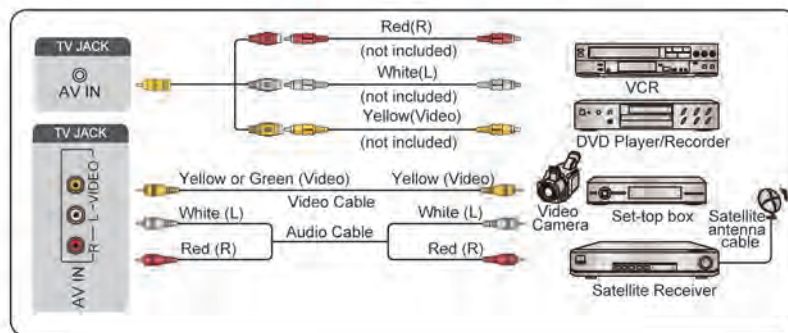

Note:

- AV IN port(s) may vary depending on model type.
- AV IN port(s) may not be available in some models. Please use other port(s) to connect AV devices.

Connect with a HDMI cable

To connect an AV device with a HDMI cable (not provided), see the illustration below.

When the connection is completed, using your remote control, press **INPUT** button, and select the corresponding HDMI input.

Connecting to External Devices

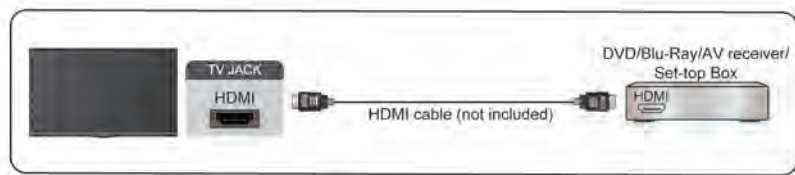

Note:

- Please refer to the User Manual of your device for step-by-step instructions.
- Some devices, such as DVD players, require the HDMI signal to be set to the correct format in the device settings. Please consult your device user manual for instructions.
- If there is no sound from your TV, configure the device audio settings.

Related information

Use [HDMI&CEC](#) on page 20

Connecting Speakers or Other Audio Receivers

To connect speakers or other audio receivers with an audio cable (not provided), see the illustration below.

Ensure the audio connected devices are switched on before switching on the TV.

When a digital audio system is connected to the DIGITAL AUDIO OUT port, decrease the TV volume, and use your digital audio system to control the volume.

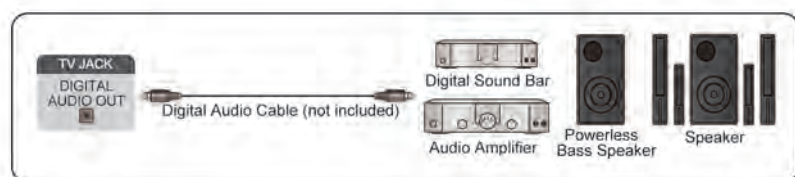

Note:

- If you prefer to use Audio Return Channel/Enhanced Audio Return Channel, please refer to [Connecting to External Devices > Connecting a Digital Audio System with ARC](#) in this manual.
- You can connect the DIGITAL AUDIO OUT port on the back of the TV to the optical port on the amplifier. Then go to **Settings > Display & Sound > Sound > Digital Audio Out** to choose to select **Dolby Audio - Dolby Digital** to receive the Dolby Digital audio.

[Select Speakers](#)

Connecting a Digital Audio System with ARC

If you would like to use the Audio Return Channel (ARC) feature to send sound from the TV by a HDMI cable to a digital sound system, you can connect it to the HDMI (ARC) port of your TV.

By using this feature, you can also control the sound system with your TV remote instead of using the remotes for each device.

Connecting to External Devices

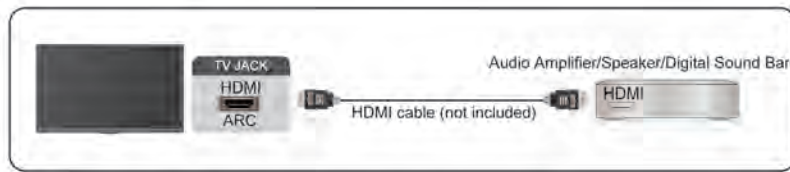

After the connection:

1. Power on the sound system.
2. Press **⊙** button on your remote control to select **Settings > Display & Sound > Sound > Audio Output > ARC**

Note:

- Audio receiver must support ARC function.
- If the device has an Input Selector feature, then make sure to change it to TV.
- When this port is used for ARC function, it can be used as signal input when a DVD is connected to an amplifier and the amplifier is connected to the TV at the same time. Some amplifiers may not support series connection.
- 5.1 CH (channel) audio is available when the TV is connected to an external device that supports 5.1 channel surround sound. You can press **⊙** button on your remote control to select **Settings > Display & Sound > Sound > Advanced Settings > Digital Audio Out** to choose **Dolby Audio - Dolby Digital Plus** to receive the 5.1 channel audio.

Related information

[Select Speakers](#)

Connecting a PC

You can connect a PC to the TV with a HDMI cable to use your TV as a PC monitor.

After connecting the PC, press **INPUT** button. Select the connected PC as the input source.

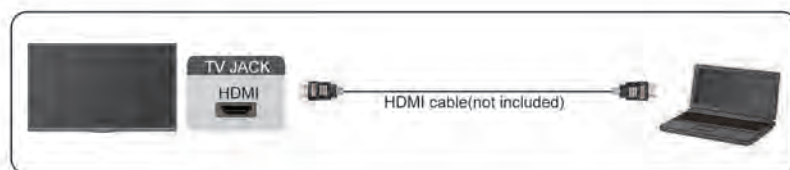

Note:

- For better image quality, set the PC's resolution, and make sure the resolution is supported by the TV.
- If there is no sound from your TV, change the PC's audio settings.
- If you want to connect your PC and TV wirelessly, please refer to [Benefits of Smart TV > Content Sharing](#) or [Connecting to External Devices > Sharing your Smart Phone/Computer Screen on the TV](#) in this manual.

Settings Overview

Picture

Adjust picture mode, picture size and other advanced picture settings.

Use the Backlight

Press **⊕** button on your remote control to select **Settings > Display & Sound > Picture > Backlight**

You can change the overall brightness of the screen.

- **Dynamic Backlight Control (or Local Dimming if support)**

Enable the TV to automatically adjust the backlight by sections according to the changes in the image and increase the contrast.

- **Backlight Level**

Adjust the bright you want images to appear, lower settings create darker images.

- **Automatic Light Sensor**

Enable the TV to automatically adjust the picture settings according to the amount of ambient light in your room.

- **Light Sensor Shift**

Adjust the lower point of the dynamic backlight adjustment scope. This is a money-saving feature because it reduces power consumption.

Note:

- Some functions above may not be applicable in some models/countries/regions.

Related information

[Picture Issues](#) on page 55

Choose a picture mode

Press **⊕** button on your remote control to select **Settings > Display & Sound > Picture > Picture Mode**.

You can select the picture mode that provides the best viewing experience.

Note:

- Options may differ depending on your model/country/region and the content you are watching. Please refer to the specific product.

When you use a normal signal

If you would like to configure the settings for your picture, then there are some types of picture modes available:

- **Vivid**

You can enjoy vivid experience.

- **Standard**

Use Standard mode for watching normal content, such as News, Drama or Documentaries.

- **Energy Saving**

Energy Saving mode can save energy.

Settings Overview

- **Game**

Enable Game Mode to optimize the TV's settings to enjoy a better gaming experience with a PC or a game console connected to the TV.

- **Sports**

Optimized picture for watching sports.

- **Theater Day**

Theater Day corresponds to the quality effect of different ambient brightness scenes.

- **Theater Night**

Theater Night corresponds to the quality effect of different ambient brightness scenes.

- **FILMMAKER MODE**

A picture quality mode.

Note:

- There is no Game mode in tuner and USB source.

Low Blue Light for TUV Certification

Theater Day and Theater Night are designed to reduce the level of blue light to protect your eyes.

Go to **Settings > Display & Sound > Picture > Picture Mode**, and select **Theater Day/Theater Night**.

To reduce the eye strain and protect eyes when you watch TV for a period of time, you are suggested to:

- Take regular and frequent breaks to avoid watching TV for a long period of time. Long time of watching may cause you eye fatigue. It is not recommended to watch TV for more than one hour.
- Look away from the TV screen and look at distance objects during the breaks for at least 10 minutes for eye care.
- Relax yourself during a break by doing eye exercises or outdoor activities.
- The best recommended viewing distance is 3 times the vertical height of the TV screen.

Proper breaks and exercises are proved excellent help to relieve eye strain and fatigue.

Note:

- This feature may not be applicable in some models/countries/regions. Low blue light certification may vary by model.

When you use a HDR signal

HDR (high dynamic range) can improve the viewing experience with higher contrast and vivid colors. Bright whites look brighter and dark blacks look darker. TV can display a wide range of colors.

Note:

- When you use a HDR signal, the picture mode is HDR picture mode.

When you use a Dolby Vision signal

Inspired by cinema technology, Dolby Vision is the format that allows your TV to deliver a full range of colors, high dynamic range images, brighter whites and dark blacks using scene-by-scene calibration.

Note:

- When you use a Dolby Vision signal, the picture mode is Dolby Vision picture mode.

Settings Overview

Related information

[Picture Issues](#) on page 55

Adjust the picture quality for each picture mode

Press  button on your remote control to select **Settings > Display & Sound > Picture > Contrast/Brightness/Color/Tint/Sharpness**.

Choose a picture mode and then adjust the settings.

- Contrast
Adjust the Contrast level to increase or decrease how bright images appear.
- Brightness
Adjust the Brightness level to generate lighter or darker images.
- Color
Adjust the color intensity of the picture for a more vibrant image.
- Tint
Adjust the colors from green to magenta tint to view the natural skin tones of people on the screen.
- Sharpness
Adjust how sharp or soft edges of images appear.

Related information

[Picture Issues](#) on page 55

Change the Picture Size

Press  button on your remote control to select **Settings > Display & Sound > Picture > Picture Size**

You can adjust the Aspect Ratio to stretch or zoom in on your picture. You can choose from the following settings: **Auto**, **Normal**, **Zoom**, **Wide**, **Direct**, **Dot-By-Dot**, **Panoramic** or **Cinema**.

Related information

[Picture Issues](#) on page 55

Apply Picture Settings

Press  button on your remote control to select **Settings > Display & Sound > Picture > Apply Picture Settings**

Adjust current picture mode to apply to all sources (Including both external devices and OTT sources) or just current source.

Related information

[Picture Issues](#) on page 55

Configure Advanced Settings

Press  button on your remote control to select **Settings > Display & Sound > Picture > Advanced Settings**

You can configure picture mode settings that provides the best viewing experience.

Settings Overview

- **Overscan**
Change the video size settings to slightly crop the edges of the displayed image.
- **Color Temperature**
Adjust how warm (red) or cool (blue) the white areas of an image appears.
- **Motion Enhancement**
Reduce seeing afterimages that are left on the screen when viewing fast-moving objects.
If you select **Custom**, you can configure **Blur Reduction** and **Judder Reduction** manually.
- **Motion Clearness**
Improve how clear the picture appears when viewing.
- **Noise Reduction**
Improve how clear the picture appears by reducing noise.
- **Digital Noise Reduction**
Improve picture clarity by reducing video noise.
- **HDMI Dynamic Range**
Adjust the HDMI signal range to be more suitable for the content. (HDMI mode only)
- **Active Contrast**
Automatically darken dark areas and lighten light areas of images to see more details.
- **FILMMAKER MODE Auto Detection**
A picture quality mode, which can automatically switch according to the film source if you turn on.
- **Enhanced Viewing Angle**
Set to On to optimize your viewing angle, and you will enjoy a better watching experience.
- **Color Space**
Change the range of colors the TV displays.
- **Instant Game Response**
Refer to [Enabling instant game response](#) in this manual.
- **FreeSync**
Refer to [Enabling FreeSync](#) in this manual.
- **Low Blue Light**
Eye care: reduce the emission of blue light.
This function may not be applicable in some models/countries/regions.

Note:

- Some functions above may not be applicable in some models/countries/regions.

Related information

[Picture Issues](#) on page 55

Configure Calibration Settings

Press  button on your remote control to select **Settings > Display & Sound > Picture > Calibration settings**

Adjust the color space and Gamma to best suit the content you're viewing.

Settings Overview

- **Color Tuner**

Adjust the Color, Hue, Saturation and Brightness of color settings.

- **White Balance**

Adjust the intensity of red, green and blue lights to view the true colors of all images in the picture.

- **Gamma**

Adjust the Gamma to alter how the TV will respond to the grayscale content. In a dark room choose a Higher number like 2.2. In a brighter area select a Lower number like 2.0. In general, 2.4 is normally recommended.

- **Gamma Calibration**

Adjust selected Gamma curve.

- **RGB Only**

View images based on default settings or choose the color red, blue or green.

Note:

- Some functions above may not be applicable in some models/countries/regions.

Related information

[Picture Issues](#) on page 55

Reset the picture settings

Press  button on your remote control to select **Settings > Display & Sound > Picture > Reset**

Reset current picture settings back to the factory setting.

Sound

Adjust sound mode and other advanced sound settings.

Choose a Sound Mode

Press  button on your remote control to select **Settings > Display & Sound > Sound > Sound Mode**

You can select a preset sound mode suitable for the content type or the listening environment.

- **Standard**

In Standard mode, the TV delivers a flat frequency response, which preserves the natural characteristics of the original sound.

- **Theater**

Theater mode increases the surround sound effect and provides a more prominent bass response.

- **Sports**

Optimized sound for watching Sports events.

- **Music**

In Music mode, low and high frequencies are emphasised to enhance musical instrument reproduction.

- **Speech**

In Speech mode, low and high frequencies are attenuated to improve the reproduction and clarity of the human voice.

Settings Overview

- **Late Night**

In Late Night mode, the TV will improve the reproduction and clarity of the human voice with a low volume level.

- **Auto Mode**

The sound mode will be adjusted automatically.

Note:

- Auto Mode may not be applicable in some models/countries/regions.
- Sound mode adjustment is only available when you select TV speaker as audio output.

Related information



[Sound Issues](#) on page 56

Select Speakers

Press  button on your remote control to select **Settings > Display & Sound > Sound > Audio Output**

Select the speakers which you want to use.

Configuring WiSA Speaker

Press  button to select  icon, and select **Sound > WiSA Speaker**.

Wireless audio transmission can be available with Dongle provided by WiSA Ready and sound system certified by WiSA Ready.

Note:

- WiSA Speaker may not be applicable in some models/countries/regions.

Related information

[Connecting Speakers or Other Audio Receivers](#) on page 25

[Connecting a Digital Audio System with ARC](#) on page 25

Adjust the Sound Quality

Enable eARC

Press  button on your remote control to select **Settings > Display & Sound > Sound > eARC**

Connect an audio device that supports eARC via HDMI-eARC, and set eARC to On to enjoy premium sound quality.

Enable TV speaker

Press  button on your remote control to select **Settings > Display & Sound > Sound > TV Speaker**

Turn on or off the TV speaker.

Note:

- This menu is only available when you select TV speaker as audio output.

Enable TruBass HDX

Press  button on your remote control to select **Settings > Display & Sound > Sound > TruBass HDX**

Settings Overview

Optimizes overall sound quality by increasing bass, making dialog clear and natural, and widening the sound field.

Enable TruSurround: X

Press  button on your remote control to select **Settings > Display & Sound > Sound > TruSurround: X**

Provides surround sound experience with psycho-acoustic processing to place sounds beside, behind, and above the viewer. For best results use with Surround Sound.

Enable Dialog Clarity

Press  button on your remote control to select **Settings > Display & Sound > Sound > Dialog Clarity** to improve dialog clarity.

Enable TruVolume HD

Press  button on your remote control to select **Settings > Display & Sound > Sound > TruVolume HD**

Maintains consistent loudness levels from wide dynamic range programs, loud commercials, and channel or input changes.

Enable Dolby Atmos

Press  button on your remote control to select **Settings > Display & Sound > Sound > Dolby Atmos**

Set Dolby Atmos to On to enhance the richness of sound, and you can enjoy an immersive listening experience.

Enable Wall Mount Setup

Press  button on your remote control to select **Settings > Display & Sound > Sound > Wall Mount Setup**

Automatically optimize the sound based on the position of the TV.

Note:

- **Wall Mount Setup** is only available when you select TV speaker as audio output.
- The menu may vary, depending on the actual display of the TV.

Related information

[Sound Issues](#) on page 56

Configure Advanced Settings

Press  button on your remote control to select **Settings > Display & Sound > Sound > Advanced Settings**

Tune the audio settings and quality of the TV.

Balance

Adjust the left and right speaker strength to optimize audio for a specific location.

Volume Level

Balance the sound volume of each source.

Settings Overview

Auto Volume Control

Activate to prevent the volume from changing when you switch TV channels.

Digital Audio Out

Select the digital audio output format that best suits the audio device type.

Note:

- When using optical connection, PCM and Dolby Digital are suggested.
- If your external audio device does not support Dolby or DTS, PCM is suggested.

Digital Audio Delay

Adjust the digital audio output delay time to sync sound from an external speaker with the images on the TV.

Note:

- Digital Audio Out and Digital Audio Delay functions are only applicable when Audio Output is set to ARC or when external audio players are connected via DIGITAL AUDIO OUT jack.

Lip Sync

Synchronize the displayed image with the audio output.

Equalizer

Boost the volume at different frequencies.

Headphone Settings Setup

Set the sound output mode through headphones.

After connecting your wired or Bluetooth headphone, or other external audio amplifiers, you can set up your TV to your preference.

Note:

- This function may not be applicable in some models/countries/regions.
- **Headphone Mode**
Change the way audio is sent through the type of device that's connected to your TV Audio Out port.
- **Headphone Volume**
Independently adjust the volume of audio out devices.

Related information

[Connecting Bluetooth Devices](#) on page 21

[Connecting Headphones](#) on page 23

[Connecting Speakers or Other Audio Receivers](#) on page 25

[Connecting a Digital Audio System with ARC](#) on page 25

Resetting the sound settings

Press  button on your remote control to select **Settings > Display & Sound > Sound > Reset**

Reset current audio settings to factory mode.

Settings Overview

Network & Internet

You can connect to the internet with Wi-Fi, ethernet, or your phones hotspot.

For additional information about Network & Internet, please refer to [First-Time Use > Connect to the Internet](#) in this manual.

Data saver

Press  button on your remote control to select **Settings > Network & Internet > Data saver**

Automatically adjusts video quality to use less mobile data. Data Saver will monitor and limit your network traffic.

You can turn this feature On or Off depending on your needs.

Related information

[My TV cannot connect to the network.](#) on page 50

[Connect to a Wired \(Ethernet\) Network](#) on page 3

[Connect to a Wireless Network](#) on page 4

Data usage and alerts

Press  button on your remote control to select **Settings > Network & Internet > Data usage and alerts**

You can see how much data you used today, also you can set data alerts to On to remind you.

For additional information about Network & Internet, please refer to First-Time Use section.

Related information

[My TV cannot connect to the network.](#) on page 50

[Connect to a Wired \(Ethernet\) Network](#) on page 3

[Connect to a Wireless Network](#) on page 4

Scanning always available

Press  button on your remote control to select **Settings > Network & Internet > Scanning always available**

Let Google's location service and other apps scan for networks, even when Wi-Fi is off.

Related information

Related information

[My TV cannot connect to the network.](#) on page 50

[Connect to a Wired \(Ethernet\) Network](#) on page 3

[Connect to a Wireless Network](#) on page 4

General

You can set up system settings.

Note:

- The menus displayed vary depending on models/countries/regions.

Settings Overview

Set Time

Press  button on your remote control to select **Settings > System > Date & time**

- Automatic date & time
Set to On to use network-provided time.
You can also set the current time manually when Off is selected.
When Off is selected, the TV Network may not be working properly.
- Set date
Set the date.
- Set time
Set the time.
- Set time zone
Select your time zone.
- Use 24-hour format
Set the time to display in a 12 or 24-hour format.

Use Timer

Press  button on your remote control to select **Settings > System > Power & Energy > Power**

- Sleep Timer
Set the sleep timer to automatically turn the TV off within a specified time: off, 10 Minutes, 20 Minutes, 30 Minutes, 40 Minutes, 50 Minutes, 60 Minutes, 90 Minutes and 120 Minutes.
- Power On Timer Type
Set the type Off, Daily, Once.
- Power On Timer
Set the clock for the time you want the TV to turn on automatically.
- Power Off Timer Type
Set the type Off, Daily, Once.
- Power Off Timer
Set the clock for the time you want the TV to turn off automatically.

Set Language

Press  button on your remote control to select **Settings > System > Language**

Adjust the default Language settings for the TV.

Ambient Mode Settings

Press  button on your remote control to select **Settings > System > Ambient mode**

Activate a screensaver when your TV displays a still image for a period of time. Set the time according to your preference.

Settings Overview

Configure Device Preferences Settings

Keyboard

Press  button on your remote control to select **Settings > System > Keyboard**

Adjust the default settings for the keyboard.

Storage

Press  button on your remote control to select **Settings > System > Storage**

View the TV storage.

Power & Energy

Press  button on your remote control to select **Settings > System > Power & Energy**

Power on behavior

Select the screen to start when powering on the TV.

You can select **Home screen** or **Last input**.

Energy saver

Turn off display after 15 minutes, 30 minutes, 1 hour, 4 hours, 8 hours, 12 hours, 24 hours, Never.

Power

You can set **Power LED** ON or OFF, set **Power On Mode** to **Remember**, **Standby**, **On**.

Cast

Press  button on your remote control to select **Settings > System > Cast**

This function is remote control notification.

Let others control your cast media. Show a notification on all Android devices connected to your Wi-Fi and let them control media casting to this device.

You can select **Always**, **While casting**, **Never**.

System sounds

This is a switch for system sounds.

Related information

[Use Timer](#) on page 36

Configure Advanced System Settings

Press  button on your remote control to select **Settings > System > Advanced System**.

Screenless Mode

By turning Screenless Mode On or Off, you can enable or disable the WOC functions. When Screenless Mode is set to Off, you will not be able to remotely wake up the TV through external devices.

If your models support Hands-free Voice Control function, you can talk to the Google Assistant even when the screen is off. In screenless Mode, the Google Assistant is always available to help even when the screen is

Settings Overview

not on. Just say "OK Google/Hey Google". This feature will affect standby power consumption when it is set to On.

Note:

- The Google Assistant and some features are available on limited country/region/language.

Enhanced Viewing

You can set Automatic Content Recognition, Picture Mode Auto Adaptation and Sound Mode Auto Adaptation.

Note:

- To use Enhanced Viewing, connect your TV to network first.
- This function may not be applicable in some models/countries/regions.

Serial/IP Control Port

Our TV supports IP control feature within the local area network (LAN). TV can accept the spec-compliant instructions issued by the device in the same local area network through the pre-defined network interface and command format, like shutdown, volume up/volume down, switch channels, etc.

Note:

- This function may not be applicable in some models/countries/regions.

Control4 Control Port

TV can be compatible with control 4 devices. Control and linkage between devices can be achieved through drivers and protocols provided by Control 4.

Note:

- This function may not be applicable in some models/countries/regions.

Product Registration

Visit <https://www.hisense-usa.com/support/register> or scan the QR code with another device (cellphone, tablet..) to complete your registration.

Note:

- The website and the QR code may be different in some countries/regions.

E-Manual

Scan QR code to display E-Manual.

Clear Cache

Clear cache of applications and system.

Support

You can set up support settings.

Note:

- The menus displayed vary depending on models/countries/regions.

Settings Overview

System message

Press  button on your remote control to select **Settings > System > Advanced System > Help > System message**

View system message, including: Serial Number, Service Code, Software Version, etc.

Support information

Press  button on your remote control to select **Settings > System > Advanced System > Help > Support information**

View Support URL, Support Number, Email, etc.

Signal Information

Press  button on your remote control to select **Settings > System > Advanced System > Help > Signal Information**

Perform self diagnosis to test Video Format, Audio Format, Color Depth, etc.

Check Software Version

To check the current software version of your TV:

Press  button on your remote control to select **Settings > System > Advanced System > Help > System message**

System Update

Press  button on your remote control to select **Settings > System > About > System update**

Set your TV to receive the latest firmware. Provide software updates to continuously enhance your TV and correct any issues that may impact your user experience; therefore, recommend you to keep your TV connected to the Internet to automatically receive updates when they are available.

Set Usage Mode

Set the TV to use in Home or Store mode.

Home Mode

Select Home Mode for normal TV usage.



If you want to switch to Store Mode when the TV is in Home Mode, turn on **Store Mode** at  > **Settings > System > Advanced System**.

Store Mode

Select Store Mode to setup the TV in a retail setting. This mode enables E-Pos and other demo functions and is only intended for use in retail stores.

When Store Mode is selected, press  button on your remote control to enter store mode settings.

Settings Overview

If you want to switch to Home Mode when the TV is in Store Mode, press  button on your remote control to enter **Store Mode Settings** and choose **Home Mode**. Alternatively, turn off **Store Mode** at  > **Settings** > **System** > **Advanced System**.

Note:

- Enabling Store Mode could increase energy consumption.
- How to exit Store Mode varies depending on models/countries/regions.

Using Parental Control

Press  button to select **Settings** > **Channels & Inputs** > **Parental Control**.

The Parental Control setting allows you to block content that is not appropriate for children to watch.

- **Locks**

Turning Parental Control On

1. Turn on Locks to enable the Parental Control function.
2. Create PIN window displays. Using the D-pad on your remote control, create the password.
3. You will see other Parental Control settings change from a greyed out state to highlighted. When this occurs, begin adding other settings to the **Scheduled Blocking**, **Channel Blocking**, **Program Blocking**, **Input Blocking**, **Change PIN** and **Reset** features.

- **Scheduled Blocking**

Block certain channels, programs and inputs during certain periods of time.

- **Channel Blocking**

Block selected channels.

- **Program Blocking**

Block programs by ratings.

- **Input Blocking**

Block selected inputs.

- **Change PIN**

Change the PIN that you use to access Parental Control.

Note:

If you forget your password, call the Consumer Electronics Care Centre.

- **Reset**

Reset Parental Control back to the factory setting.

Reset to Factory Default

Press  button on your remote control to select **Settings** > **System** > **About** > **Reset** > **Factory reset**

Restore your device to default settings and erase all data, accounts, files, and downloaded apps.

Game

You can connect to your game console and set up settings to optimize the TV screen for better gaming performance.

Connect a Game Console

You can connect your game console with a HDMI cable to the TV.

To start a game from a game console:

1. Switch on your game console.
2. Press  button on your remote control to select **Inputs** or press **INPUT** button. Select the connected game console as the input source.
3. Start the game.

You can enable the game mode to optimize your TV's settings when playing games with a game console.

Related information

[Enabling game mode](#) on page 41

Enabling game mode

Press  button on your remote control to select **Settings > Display & Sound > Picture > Picture Mode > Game**

Enable **Game Mode** to optimize the TV's settings to enjoy a better gaming experience with a PC or a game console connected to the TV.

Game Mode will allow:

- Reducing input lag to make sure every press or click matches what is happening on the screen;
- Improving responsiveness to produce very little motion blur;
- Processing YUV 4:4:4 format signals precisely to present accurate image colors.

Note:

- This function may not be applicable in some input sources or applications.

Related information

[Connect a Game Console](#) on page 41

Enabling instant game response

Press  button to select **Settings > Display & Sound > Picture > Advanced Settings > Instant Game Response**

You can enjoy a smooth viewing experience with external device connected to the TV when **Instant Game Response** is turned on.

Note:

- When Game mode is selected, Instant Game Response will not be switched off automatically.

Enabling FreeSync

Press  button to select **Settings > Display & Sound > Picture > Advanced Settings > FreeSync**

Entertainment

You can enjoy a smooth viewing experience with external device connected to the TV when **FreeSync** is turned on.

Note:

- Some functions above may not be applicable in some models/countries/regions.

SoundBar Settings

When the soundbar device is connected to the TV, You can change the SoundBar Settings at Settings menu for best device sound quality.

When the ARC device is connected to the TV, the sound output is automatically switched to ARC, if the user switches to other sound output channels, the soundbar menu cannot be adjusted, and the sound menu of TV can be adjusted.

Press  button on your remote control to select **Settings > Display & Sound > Sound > SoundBar Settings**

Note:

- When you connect a soundbar with an HDMI cable, you should Set **HDMI control** to **On**.  > **Settings > Channels & Inputs > Inputs > HDMI control**
- **EQ Modes**
You can select **Music, Movie, News, Sport, Night**.
- **Surround Modes**
You can set to **On** to turn on the Surround Modes.
- **Bass Level/Treble Level/Dimmer Level**
You can adjust **Bass Level/Treble Level/Dimmer Level**
- **Reset**
Reset current SoundBar Settings to factory mode.

Sports

Sports mode setup in picture or sound settings

Press  button on your remote control to select **Settings > Display & Sound > Picture > Picture Mode > Sports**

Optimized picture for watching sports.

Press  button on your remote control to select **Settings > Display & Sound > Sound > Sound Mode > Sports**

Optimized sound for watching sports events.

Media

Media is a central location for you to view or listen to different types of content, such as photos, music and movies. You can view media content through the following methods:

- A USB thumb drive or hard drive.

Entertainment



- Compatible mobile phone, tablet or other personal devices: you can stream movies, music and photos that are stored on compatible personal device and play or view the content on your TV.

By default, there is **Content Sharing** displayed on the Media screen. If your mobile device is connected to the TV, its name also appears on the Media screen.

For more information about **Content Sharing**, please refer to [Benefits of Smart TV > Content Sharing](#) in this manual.

Enjoy Photos/Audio/Video Stored on a USB Device

You have some ways to enter Media:

- Insert a USB device, a prompt message appears, press  to open it.
- Press  button to select **MediaCenter** from your Apps list on home page.
- Press  button to select **Settings > Apps > MediaCenter > Open**

Then select **connected devices**.

Select the content you want to play on the screen, like pictures, videos and music.

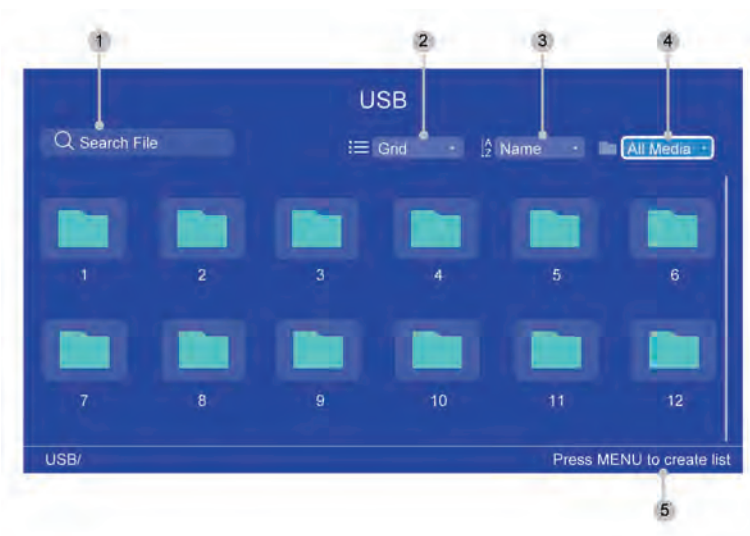

- 1 Search the content you want to play.
- 2 Arrange the content list by **Grid, List**.
- 3 Sort the content list by **Name, Date Modified, Size**.
- 4 Filter the content list by **All Media, Music, Photos, Videos**.
- 5 Create a photo, music, or video playlist./Press LEFT button to browse the connected devices. /Press MENU button to edit.

Note:

- Some options in the above table may not be available in some models/countries/regions.
- The image is only for reference and may differ from the actual product.

Media format list

Due to differences in programming tools and other factors, some of the file formats that are listed may not be supported.

The listed formats may not be supported depending on the model.

Video Format

| Container | Video Codec | File Extension Name | Resolution and Frame Rate |
|-----------------------|-------------|-------------------------|---------------------------|
| MPEG program stream | MPEG1/2 | .DAT, .VOB, .MPG, .MPEG | 1920 x 1080 @ 60fps |
| | MPEG4 | | |
| | H.264 | | 3840 x 2160 @ 60fps |
| MPEG transport stream | HEVC/H.265 | .ts, .trp, .tp | 3840 x 2160 @ 60fps |
| | MPEG4 | | 1920 x 1080 @ 60fps |
| | H.264 | | 3840 x 2160 @ 60fps |
| | VC1 | | 1920 x 1080 @ 60fps |
| | MPEG1/2 | | 1920 x 1080 @ 60fps |
| | AVS | | |
| | AVS+ | | |
| | AVS2 | | 3840 x 2160 @ 60fps |
| MP4 | VP8 | .mp4, .mov | 1920 x 1080 @ 60fps |
| | AV1 | | 3840 x 2160 @ 60fps |
| | HEVC/H.265 | | |
| | MPEG1/2 | | 1920 x 1080 @ 60fps |
| | MPEG4 | | |
| | H.263 | | |
| | H.264 | | 3840 x 2160 @ 60fps |
| | WMV3 | | 1920 x 1080 @ 60fps |
| | VC1 | | |
| | Motion JPEG | | 1920 x 1080 @ 30fps |
| MKV | VP9 | .mkv | 3840 x 2160 @ 60fps |
| | HEVC/H.265 | | |
| | MPEG1/2 | | 1920 x 1080 @ 60fps |
| | MPEG4 | | |
| | H.264 | | 3840 x 2160 @ 60fps |
| | WMV3 | | 1920 x 1080 @ 60fps |
| | VC1 | | |
| | Motion JPEG | | 1920 x 1080 @ 30fps |
| | VP8 | | 1920 x 1080 @ 60fps |

Entertainment

| Container | Video Codec | File Extension Name | Resolution and Frame Rate |
|-----------|----------------|---------------------|---------------------------|
| AVI | AV1 | .avi | 3840 x 2160 @ 60fps |
| | HEVC/H.265 | | 3840 x 2160 @ 60fps |
| | MPEG1/2 | | 1920 x 1080 @ 60fps |
| | MPEG4 | | |
| | Sorenson H.263 | | |
| | H.263 | | 3840 x 2160 @ 60fps |
| | H.264 | | |
| | WMV3 | | 1920 x 1080 @ 60fps |
| | VC1 | | 1920 x 1080 @ 30fps |
| | Motion JPEG | | |
| VP8 | | | |
| FLV | HEVC/H.265 | .flv | 3840 x 2160 @ 60fps |
| | MPEG4 | | 1920 x 1080 @ 60fps |
| | Sorenson H.263 | | 3840 x 2160 @ 60fps |
| | H.263 | | |
| | H.264 | | |
| | Motion JPEG | | 1920 x 1080 @ 30fps |
| | VP8 | | 1920 x 1080 @ 60fps |
| WEBM | VP9 | .webm | 3840 x 2160 @ 60fps |
| | VP8 | | 1920 x 1080 @ 60fps |
| | AV1 | | 3840 x 2160 @ 60fps |

Audio Format

| Container | Audio Codec | File Extension Name |
|-----------|-----------------------|---------------------|
| WAV | MPEG1/2 Layer1 | .wav |
| | MPEG1/2 Layer2 | |
| | MPEG1/2/2.5 Layer3 | |
| | AAC-LC, HEAAC | |
| | DTS | |
| | LPCM | |

Entertainment

| Container | Audio Codec | File Extension Name |
|-----------|-----------------------|---------------------|
| | IMA-ADPCM MS-ADPCM | |
| | G711 A/mu-law | |
| MP3 | MPEG1/2 Layer1 | .mp3 |
| | MPEG1/2 Layer2 | |
| | MPEG1/2/2.5 Layer3 | |
| AAC | AAC-LC, HEAAC | .aac |
| WMV | WMA | .wma, .wmv |
| | WMA 10 Pro M0 | |
| | WMA 10 Pro M1 | |
| | WMA 10 Pro M2 | |
| FLAC | FLAC | .flac |

Photo Format

| Image | Photo | Resolution |
|-------|-------------|--------------|
| JPEG | Base-line | 15360 x 8640 |
| | Progressive | 1024 x 768 |
| PNG | | 9600 x 6400 |
| BMP | | 9600 x 6400 |
| GIF | | 6400 x 4800 |
| WebP | | 3840 x 2160 |
| HEIF | | 4000 x 3000 |

Accessibility Menu Setup

Press  button on your remote control to select **Settings > System > Accessibility**.

Accessibility function provides menu options and audio descriptions to aid the visually or hearing impaired.

- **Captions**

Displays and sets the closed captions. You can set display options and select caption style.

- **Live TV Closed Captioning**

- Live TV Closed Captioning

- Analog Closed Caption

- Digital Closed Caption

- Digital Caption Style

- **Captions**

- **High contrast text**

Improves contrast for the visually impaired.

- **Text to speech**

Let you specify text-to-speech engine details and speech rate.

- **Accessibility shortcut**

When the shortcut is on, you can press both the back and down buttons for 3 seconds to start an accessibility feature.

- **TalkBack**

Controls spoken feedback for visually impaired users.

- **Switch Access**

Switch Access can collect all of the text you type, except passwords. This includes personal data such as credit card numbers.

Note:

- Some options in the above table may not be available in some models/countries/regions.
- The menu is only for reference and may differ from the actual product.

Related information

[Video Description](#) on page 11

Troubleshooting

FAQ

In this section you will find the answers to the most frequently asked questions.

Note:

- The images are only for reference and may differ from the actual product.

There is no picture, or the picture is black and white.

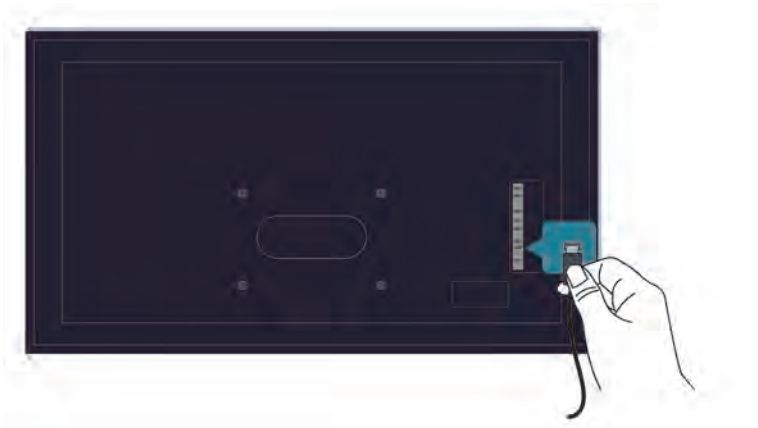

Check input cable connections.

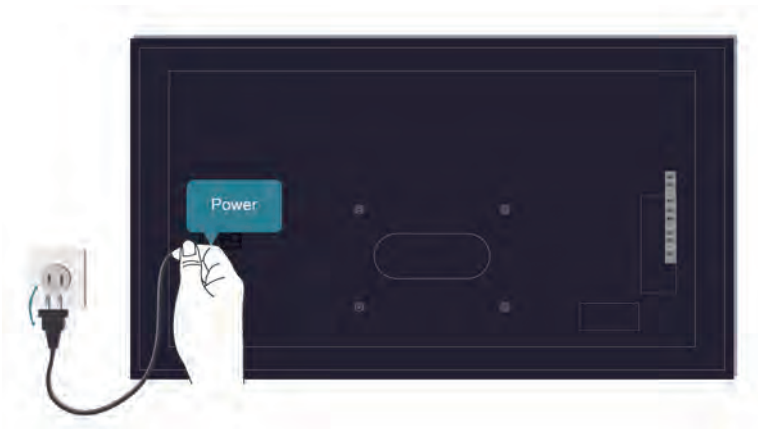

Unplug the TV power cord from AC outlet and re-plug after 60 seconds.

Troubleshooting

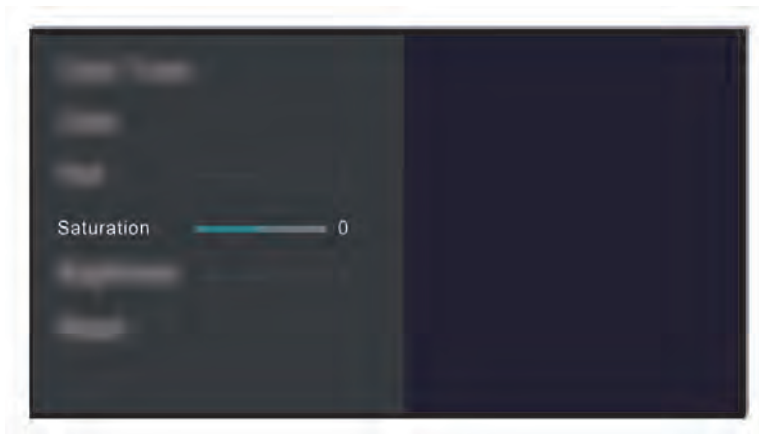

Check if the color saturation is set to 50 or higher at **⚙️ > Settings > Display & Sound > Picture > Calibration Settings > Color Tuner > Saturation.**

There is no sound or the sound is too low.

There is no sound or the sound is too low at maximum volume.

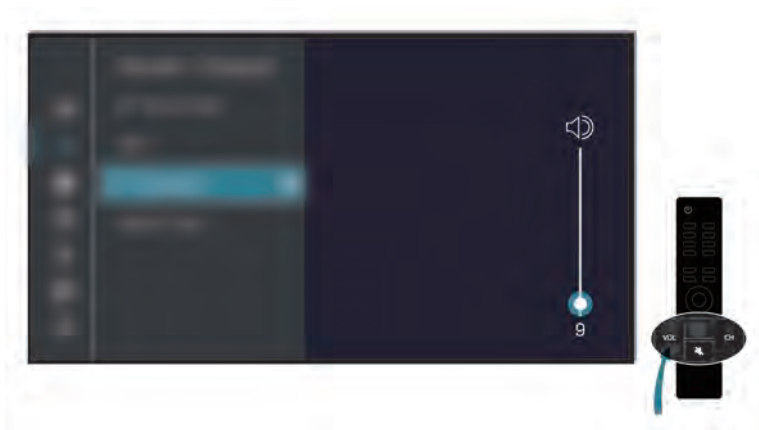

Check if Mute mode is set to on.

Check the volume settings.

Check the volume control of the device (cable or satellite box, DVD, Blu-ray, etc.) connected to your TV.

Troubleshooting



Make sure that the audio cable is connected to the correct audio output connector on the external device.

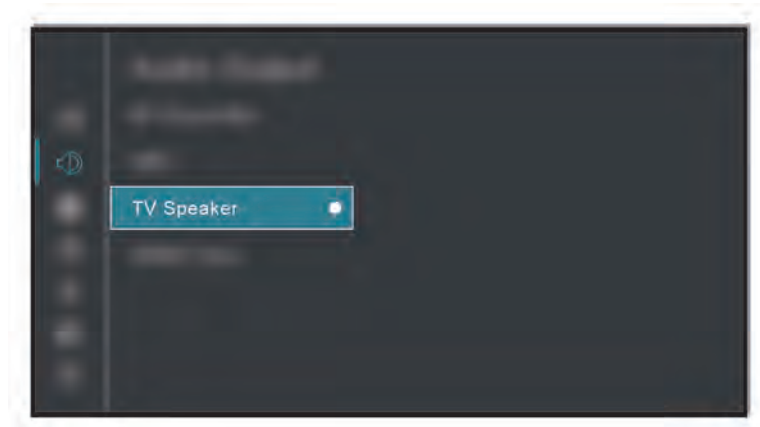

Check whether **TV Speaker** is selected at **⚙️ > Settings > Display & Sound > Sound > Audio Output**.

My TV cannot connect to the network.

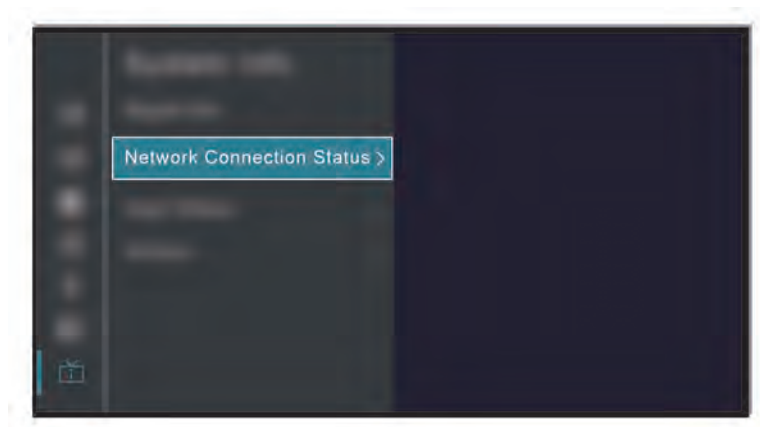

Check network status at **⚙️ > Settings > System > About > Status**.

Troubleshooting

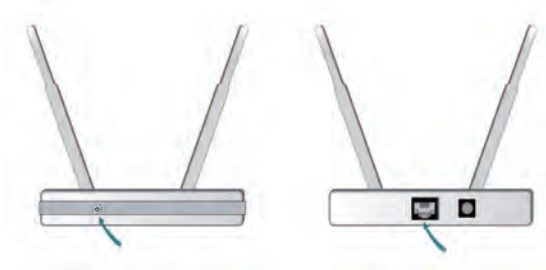

Make sure your modem/wireless router is on and connected to the Internet.



Position your wireless router, modem router, or access point in a central location. Avoid putting it in a corner.

External source connected but no picture or sound.

I have connected an external source to my TV but I get no picture and/or sound.



Check whether the connection between the external device and your TV is correct and secure.

Troubleshooting



Make sure you have made the correct selection of input source.

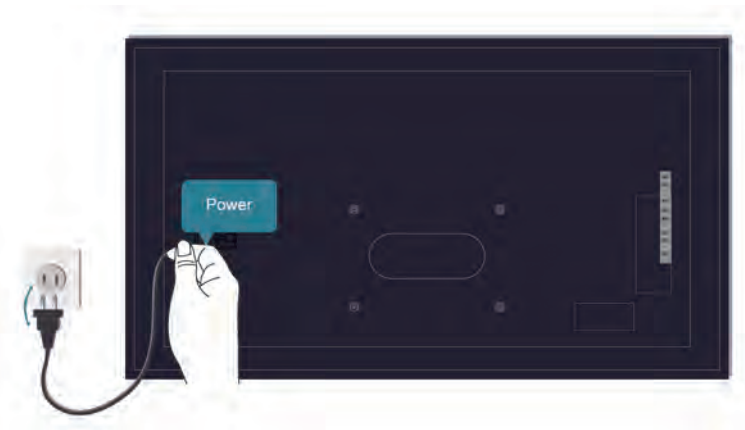

If the signal is intermittent, unplug the TV power cord from AC outlet and re-plug after 60 seconds.

When devices are connected with HDMI cables

- If there is always no signal, or the signal cannot be restored after plugging and unplugging, you can press  button to select **HDMI Format** in HDMI source, to confirm whether the signal can be recognised.
- Change to another HDMI port.
- Change to another HDMI cable.

The remote control does not work.

Confirm that TV still has power and is operational. Press the power button on the TV to determine if the problem is with the remote control or not.

Troubleshooting



If the TV is not responding to the remote control, then please check if the small light on the remote control flashes when any button is pressed (some remote controls do not support this function).

If the small light does not flash when the remote control button is pressed, the battery power may be low, please replace the batteries with new ones.

Check that the orientation of each battery matches the positive (+) and negative (-) symbols in the battery compartment.





Keep the remote control sensor area clear from obstacles.

Troubleshooting

For Bluetooth remote controls



If the TV does not respond with the Bluetooth remote control, try pairing the remote control to the TV by pressing and holding the  and  button at the same time.

Schedule Recording cannot be used.

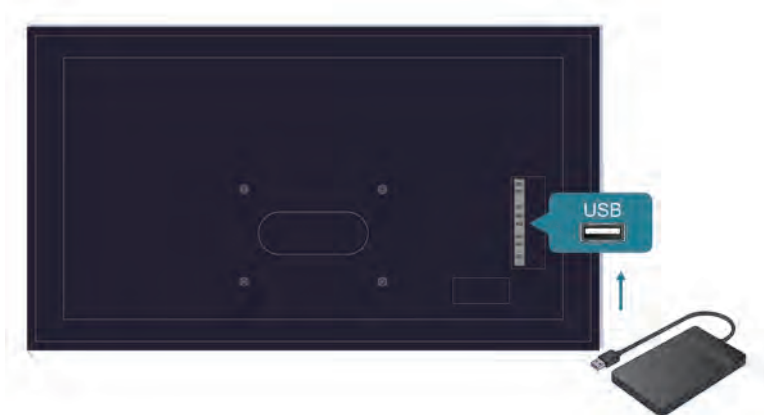

Check if there is a storage device connected to the TV.

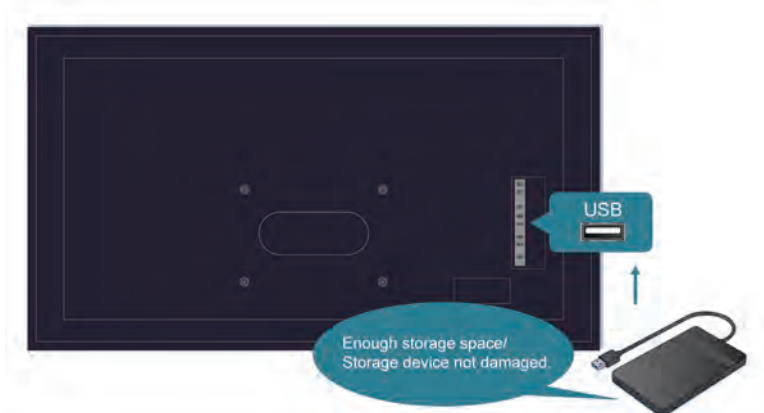

Troubleshooting

Check the free space of the storage device. The function will not work if there is not enough storage space on the device.

Check whether your storage device is damaged. If so, it is suggested to format your storage device.

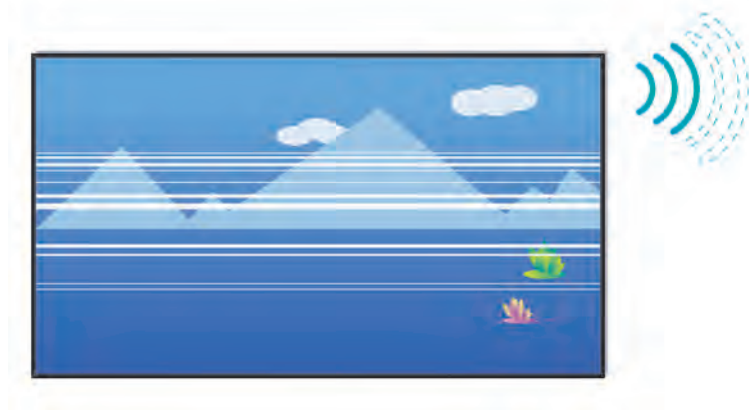

Recording will automatically stop if the signal becomes too weak.

Note:

- Recording function may not work if the read/write speed of the USB device is too slow.
- Recording function may not work because the storage format of your device is unsupported.
- The Recording functions may not be applicable in some models/countries/regions.

Remote Control Service

 > **Settings** > **System** > **Advanced System** > **Remote Control Service**

Remote Control Service enables your TV to be controlled from the client server to allow service agents to diagnose the problem of your TV and deal with the problem online efficiently.

To use this function:

1. Turn on **Remote Control Service**.
2. Select **Agree All** and **Confirm** in End User License Agreement page.
3. Select **Generate PIN** in Remote Control Service.
4. You can initiate a help request to a service agent by the hotline and provide the on-screen PIN.



Note:

- This function may not be applicable in some models/countries/regions.
- Steps above may vary. Please refer to the specific product.
- Keep the network connected when the Remote Control Service is running.

Picture Issues

When the TV has a picture problem, these steps may help resolve the problem.

Troubleshooting

| Problems | Possible Solutions |
|---|---|
| The picture is distorted. | <ul style="list-style-type: none"> The compression of video content may cause picture distortions, especially in fast moving pictures from sports programs and action movies. If the signal reception is weak or poor, screen distortion may be visible but it is not a malfunction. Mobile phones used close to the TV (within 1m) may cause noise on analogue and digital channels. |
| The picture is blurry or flickering, or cuts out momentarily. | <ul style="list-style-type: none">  > Settings > Picture > Sharpness. You can try to increase or decrease the Sharpness. If you use an external antenna, check the direction, position and connection of the antenna. Adjust the direction of your antenna, or reset or fine tune the channel. |
| The picture appears red, purple, pink and other colors. | <ul style="list-style-type: none">  > Settings > Picture > Calibration Settings > White Balance. You can try to increase or decrease the White Balance. |
| Picture distorted or appears wavy. | <ul style="list-style-type: none"> Some electrical appliances may affect the TV. If you turn off the appliance and the interference goes away, then move it further away from TV. Insert the power plug of the TV into another power outlet. |

Related information

[There is no picture, or the picture is black and white.](#) on page 48

Sound Issues

When the TV has a sound problem, these steps may help resolve the problem.

| Problems | Possible Solutions |
|--|---|
| Picture is normal, but no sound. | <ul style="list-style-type: none"> Check the volume settings. Check if 'Mute' mode is set to on. Check the volume control of the device (cable or satellite box, DVD, Blu-ray, etc.) connected to your TV. |
| The speakers are making an odd sound. | <ul style="list-style-type: none"> Make sure that the audio cable is connected to the correct audio output connector on the external device. For antenna or cable connections, check the signal information. A low signal level may cause sound distortions. |
| Sound distorted or appears wavy. | <ul style="list-style-type: none"> Some electrical appliances may affect the TV. If you turn off the appliance and the interference goes away, then move it further away from TV. Insert the power plug of the TV set into another power outlet. |
| Sound is blurry or cuts out momentarily. | <ul style="list-style-type: none"> If you use an external antenna, check the direction, position and connection of the antenna. Adjust the direction of your antenna or reset or fine tune the channel. |

Troubleshooting

Note:

- This product does not support decoding of DTS CD bitstreams. Playback of this format may produce undesirable noise.

Related information

[No sound or the sound is too low.](#) on page 49

Network Issues

If the TV network is connected, the screen will display that it is connected successfully.

| Problems | Possible Solutions |
|--|---|
| The TV cannot connect to apps. | <ul style="list-style-type: none">• Make sure the TV has a network connection.• Contact your Internet service provider. |
| The wireless network connection fails. | <ul style="list-style-type: none">• Make sure your wireless modem/router is on and connected to the Internet. |
| The wireless network signal is too weak. | <ul style="list-style-type: none">• Position your wireless router, modem router, or access point in a central location. Avoid putting it in a corner. |

Related information

[My TV cannot connect to the network](#) on page 50

Channel and Broadcast Issues

For problems while watching live TV or scanning for new services, these suggestions might help to resolve them.

| Problems | Possible Solutions |
|--|---|
| In Live TV, there is no signal, or a weak signal, or you cannot find any channels. | <ul style="list-style-type: none">• Make sure that the antenna cable is connected to the correct port.• Make sure that the antenna cable is not loose or disconnected.• If "no signal or weak signal" occasionally happens, disconnect antenna cable and reconnect it.• Run Reset to Factory Default or scan channels again.<ul style="list-style-type: none">⚙️ > Settings > System > Restart⚙️ > Settings > Channels & Inputs > Channels > Manual Scan |

Related information





[Prepare Live TV](#) on page 5

[Channel Scan](#) on page 7

External Device Connection Issues

When the TV has difficulties with external device connection, these solutions may help resolve the problem.

Troubleshooting

| Problems | Possible Solutions |
|---|--|
| The TV is having trouble receiving a signal in the cable box. | <ul style="list-style-type: none"> If there is no signal occasionally, unplug cable from TV and re-plug after 60 seconds. If there is always no signal, or the signal cannot be restored after plugging and unplugging, you can press  button to select HDMI Format if you select HDMI as input, to confirm whether the signal can be recognized. Change to another HDMI port. Change to another HDMI cable. |
| There is no sound. | <ul style="list-style-type: none"> Check whether ARC is selected at  > Settings > Display & Sound > Sound > Audio Output. If not, you need to check whether the external power amplifier device is connected to the ARC port or optical port of the TV.  > Settings > Display & Sound > Sound > Advanced Settings > Digital Audio Out. You can try to select Auto, Pass Through, PCM, Dolby Audio - Dolby Digital, or Dolby Audio - Dolby Digital Plus. Whether the power amplifier device port is connected correctly. If you select HDMI as input, you can try  > HDMI Format. |

Related information

[External source connected but no picture or sound.](#) on page 57

HDMI & CEC Issues



When HDMI & CEC is not working, these steps may help resolve the problem.

| Problems | Possible Solutions |
|---------------------------|---|
| HDMI & CEC does not work. | <ul style="list-style-type: none"> Confirm that the device is a HDMI & CEC compatible device. Check if the power cable of the HDMI & CEC device is properly connected. Check the cable connection of the HDMI & CEC device is secure. Check HDMI & CEC feature of your TV is turned on.  > Settings > Channels & Inputs > Inputs > HDMI control Check HDMI & CEC feature of the connected device is turned on. Depending on the connected HDMI device, the HDMI & CEC control feature may not work. |

Application Issues

When some apps do not play, this may help resolve the problem.

Troubleshooting

| Problem | Possible Solutions |
|---------------------------|--|
| Netflix cannot be played. | <ul style="list-style-type: none">•  > Settings > Apps > See all apps > Netflix > Force stop, then reopen to try again.• You can try to restart the TV at  > Settings > System > Restart. |

Media Files

When files do not play, this may help resolve the problem.

| Problem | Possible Solutions |
|------------------------------|---|
| Some files cannot be played. | <ul style="list-style-type: none">• Most files can be played back, but you might experience problems with corrupted files or files with high-bitrate, unsupported resolution, unsupported container or codec formats. |

Related information

[Media](#) on page 42

Voice Service Issues

When some Voice service will not function, this may help resolve the problem.

| Problems | Possible Solutions |
|------------------------|--|
| Alexa cannot be heard. | <ul style="list-style-type: none">• You can try to log into your Amazon account.• If you hear "I don't understand" from the voice recognition, please change account or log out of the account.• For more information about Alexa, please refer to Benefits of Smart TV >Using Voice Control > Alexa Setup in this manual. |

Other Issues

Use these procedures to resolve other issues that may occur.

| Problems | Possible Solutions |
|---|---|
| The TV is hot. | <ul style="list-style-type: none">• Watching TV for an extended period of time causes the panel to generate heat. The heat from the panel is dissipated through internal vents running along the top of the TV.• After extended use, you may feel heat when touching it. This heat is not a defect and does not affect the TV's functionality. |
| The TV smells of plastic. | <ul style="list-style-type: none">• This smell is normal and will dissipate over time. |
| The plastic cabinet makes a "clicking" type of sound. | <ul style="list-style-type: none">• The "clicking" sound can be caused when the temperature of the TV changes. This change causes the TV cabinet to expand or contract, which makes the sound. This is normal and the TV is OK. |

Troubleshooting

| Problems | Possible Solutions |
|---|---|
| When I turn on my TV, there is a delay for a few seconds before the picture appears. Is this normal? | <ul style="list-style-type: none">• Yes, this is normal. The TV is initializing and searching for the previous setting information. |