

# PRODUCT DIMENSIONS

SIDE VIEW

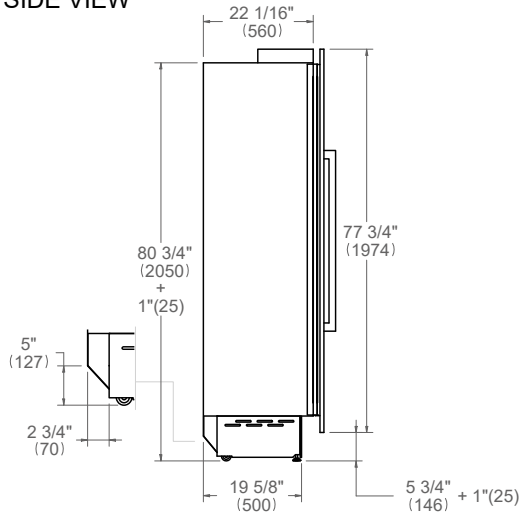

FRONT VIEW

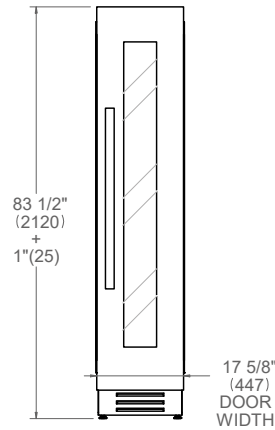

TOP VIEW

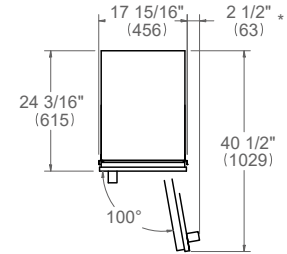

\* Maximum Overall Handle Dimension

# CUTOUT DIMENSIONS

SIDE VIEW

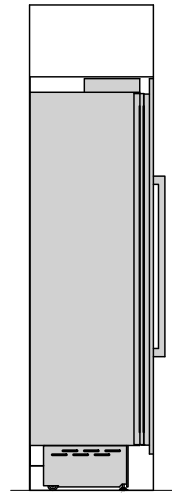

FRONT VIEW

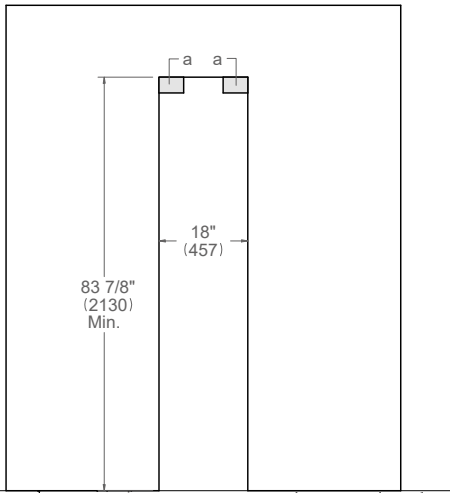

TOP VIEW

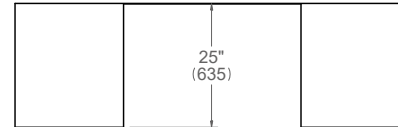

(a) Area to be left clear for the anti-tipping brackets  
3 1/2x5" (82x127mm)

# ELECTRICAL CONNECTION

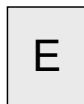

A properly-grounded, horizontally-mounted electrical receptacle should be installed according to this drawing

Connection(s) placement within the opening may require additional cabinet depth.

TOP VIEW

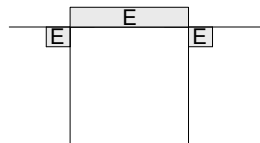

FRONT VIEW



# INSTALLATION REQUIREMENTS

If the appliance(s) is not connected through the side profile trims to secured cabinetry anti-tip brackets must be installed.

A separate circuit breaker servicing only this appliance is recommended.  
For installation of multiple products in combination, refer to the Built-in Food Preservation Design Guide.  
Dimensions in parentheses are millimeters unless otherwise specified.