

REF18FCIPRR/23

18" BUILT-IN FREEZER COLUMN RIGHT SWING DOOR, PANEL READY



Conveniently preserve food for an extended time in dry air conditions, avoid freezer burn and frost build-up.

Enjoy ample and flexible food storage thanks to Bertazzoni's columns design featuring the most usable interior depth in the category.

Serve premium ice and choose the actual ice cube size with the digitally-controlled and filtered automatic ice maker.

Access all temperature settings through the intuitive digital touch-control interface, with fast-freeze and bottle chill options.

Maintain the correct temperature in the freezer when opening the door for reloading, thanks to the unique lateral side-to-side airflow circulation.

Truly flush front alignment with the adjacent cabinets and minimal clearance with the exclusive "Lift & Swing" door hinge.

Create single, double, triple and more columns configurations to best suit your kitchen layout.

Choose Professional, Master or Heritage Series handle kit to match your other Bertazzoni kitchen appliances. Purchase Décor Sets in Gold (DS2HERTGO), Polished Copper (DS2HERTPC) or Satin Black (DS2HERTSB) to personalize your Heritage Series handles (6 handle finials per set), or in Satin Gold (DSMASHSG) or Satin Black (DSMASHSB) to customize your Master Series handles (2 handle finials per set).

2 years parts & labor warranty and 5 years warranty for the entire sealed system.

PRODUCT FEATURES

Size	H: 84" W: 18" D: 25"
Door finish	Panel ready
Interior finish	White aluminum
User interface	Internal digital TFT touch and scroll interface
Lighting	LED lights interior illumination
Shelves	2
Drawers	2
Door storage	2
Ice maker	Automatic ice maker
Ice production capacity	Up to 3 lbs / 24 hrs
Modes	Bottle cooler, Ice maker, Ice cube size, Super ice, Water filter, Vacation mode, Shopping mode, Sabbath mode
Open door alarm	Yes
Included accessories	Ice tray

INTERIOR CAPACITY

Total volume	8.2 cu.ft
--------------	-----------

TECHNICAL SPECIFICATIONS

Electrical supply	115 V 60 HZ - 327 W 3 Amp
Power connection	NEMA 5-15P with 79" power cord
Sound rating	41 dbA
Energy consumption	480.0 kWh/yr
Water connection	Rear of product
Water filter	Yes - external
Water supply pressure	8 psi to 75 psi
Certification	ETL
Warranty	2 years parts & labor Sealed system: 5 years labor
Packaging dimensions and weight	W 25 9/16" H 89" D 31 1/2" 298.0 lbs

OPTIONAL ACCESSORIES

Z330001	Replacement water filter accessory
PROHKCOL	Handle kit - Professional series
MASHKCOL	Handle kit - Master series
HERHKCOL	Handle kit - Heritage series
901561	48" Bridge toekick
901560	42" Bridge toekick

REF18FCIPRR/23

18" BUILT-IN FREEZER COLUMN RIGHT SWING DOOR, PANEL READY



PRODUCT DIMENSIONS

SIDE VIEW

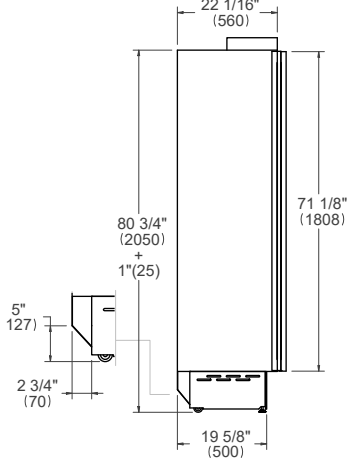

FRONT VIEW

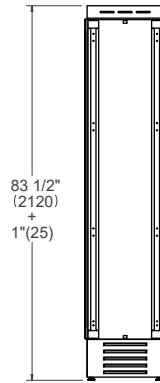

TOP VIEW

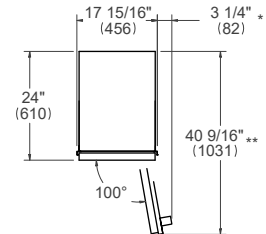

* Maximum Overall Handle Dimension
** Width of 3/4" (19mm) Door Panel

CUTOUT DIMENSIONS

SIDE VIEW

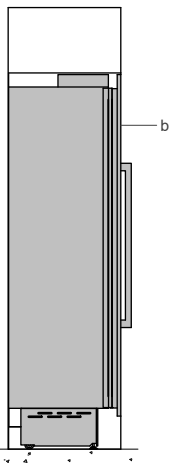

FRONT VIEW

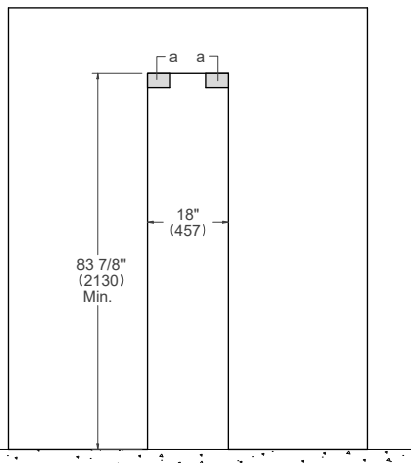

TOP VIEW

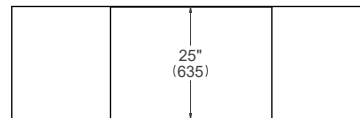

- (a) Area to be left clear for the anti-tipping brackets 3"1/2x5" (82x127mm)
- (b) Panel dimensions available on Built-in Food Preservation Design Guide or Installation Manual

ELECTRICAL & WATER CONNECTION



A properly-grounded, horizontally-mounted electrical receptacle should be installed according to this drawing



To connect to the water supply system, a 1/4" NPT waterline with accessible shut-off valve must be supplied.

Connection(s) placement within the opening may require additional cabinet depth.

A separate circuit breaker servicing only this appliance is recommended. For installation of multiple products in combination, refer to the Built-in Food Preservation Design Guide. Dimensions in parentheses are millimeters unless otherwise specified.

TOP VIEW

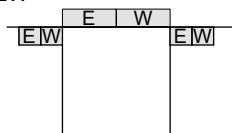

FRONT VIEW

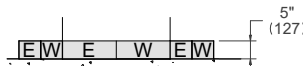

INSTALLATION REQUIREMENTS

If the appliance(s) is not connected through the side profile trims to secured cabinetry anti-tip brackets must be installed.

A separate circuit breaker servicing only this appliance is recommended.

For installation of multiple products in combination, refer to the Built-in Food Preservation Design Guide at us.bertazzoni.com or ca.bertazzoni.com

Disclaimer: while every effort has been made to ensure the accuracy of the information contained in this document, Fratelli Bertazzoni reserves the right to change it at any time without notice. For detailed installation instructions, consult the installation manual. Fratelli Bertazzoni, Bertazzoni and the winged wheel brand icon are registered trademarks of Bertazzoni Spa.